



Electronic Components

**MICROS**



2012

**DIODY I MOSTKI**

# ELEMENTY PROSTOWNICZE - 2012



## **MICROS** sp.j.

ul. E.Godlewskiego 38, 30-198 Kraków

tel. +48 12 636 95 66

fax. +48 12 636 93 99

e-mail: [biuro@micros.com.pl](mailto:biuro@micros.com.pl)

<http://www.micros.com.pl>

## Spis treści:

Diody impulsowe	<b>2</b>
Diody prostownicze	<b>4</b>
Diody zabezpieczające (transile)	<b>10</b>
Diody Schottky'ego	<b>12</b>
Diody Zenera	<b>15</b>
Mostki prostownicze	<b>18</b>

# Diody impulsowe

## Obudowa SMD0603

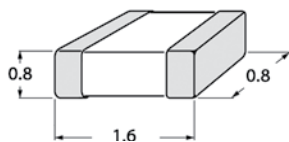

Symbol	Parametry	Rodzaj opakowania
1N4148 smd 0603	0,15A; 75V; szybkość <4ns	tape/reel

## Obudowa SMD0805

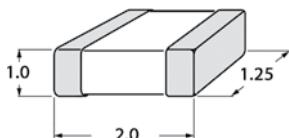

Symbol	Parametry	Rodzaj opakowania
1N4148 smd 0805	0,15A; 75V; szybkość <4ns	tape/reel

## Obudowa 1206

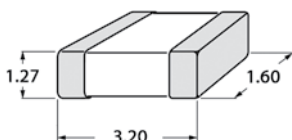

Symbol	Parametry	Rodzaj opakowania
1N4148 smd 1206	0,15A; 75V; szybkość <4ns	tape/reel

## Obudowa SOT143

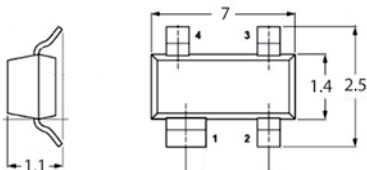

Symbol	Parametry	Rodzaj opakowania
BAS28	0,5A; 75V; ultra szybkość <4ns	tape/reel

## Obudowa SOT363

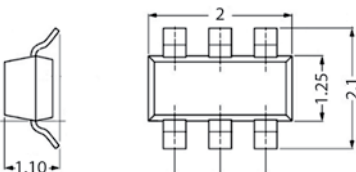

Symbol	Parametry	Rodzaj opakowania
BAV99S	0,15A; 80V; ultra szybkość <6ns	tape/reel

## Obudowa SOD323

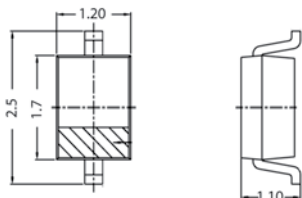
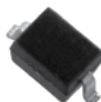

Symbol	Parametry	Rodzaj opakowania
BAS416	0,2A; 75V	tape/reel

## Obudowa SOT23

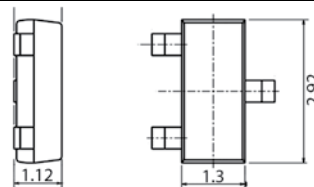

Symbol	Parametry	Rodzaj opakowania
BAT18	0,1A; 35V	tape/reel
BAS16	0,15A; 75V; ultra szybkość <6ns	tape/reel
BAV99	0,15A; 80V; ultraszybkość <6ns	tape/reel
BAL74	0,21A; 50V; ultra szybkość <4ns	tape/reel
PMBD7000	0,21A; 100V; super szybkość <4ns	tape/reel
BAR74	0,25A; 50V; ultra szybkość <4ns	tape/reel
BAW56	0,25A; 75V; ultra szybkość <4ns	tape/reel
BAS29	0,25A; 90V; szybkość <50ns	tape/reel
BAS31	0,25A; 90V; szybkość <50ns połączone w serii	tape/reel
BAS35	0,25A; 90V; szybkość <50ns wspólna anoda	tape/reel
BAS70	0,2A; 70V; ultra szybkość <5ns	tape/reel
BAS70-04	0,2A; 70V; ultra szybkość <5ns połączone w serii	tape/reel
BAS70-05	0,2A; 70V; ultra szybkość <5ns wspólna anoda	tape/reel
BAS70-06	0,2A; 70V; ultra szybkość <5ns wspólna katoda	tape/reel
BAV70	0,2A; 70V; ultra szybkość <6ns	tape/reel
BAV199	0,2A; 80V; <3us	tape/reel
BAS19	0,4A; 100V; szybkość <50ns	tape/reel
BAS20	0,4A; 150V; szybkość <50ns	tape/reel
BAS21	0,4A; 200V; szybkość <50ns	tape/reel

## Obudowa SOT143B

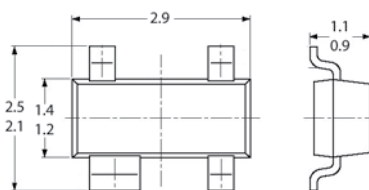

Symbol	Parametry	Rodzaj opakowania
PRTR5V0U2X	0,2A; 40V	tape/reel
BAS56	0,2A; 60V; <6ns	tape/reel

## Obudowa SOD80

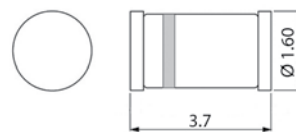
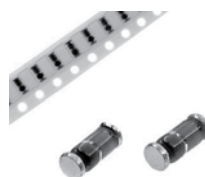

Symbol	Parametry	Rodzaj opakowania
LL4448	0,15A; 75V; szybkość <8ns	tape/reel
LL4148-GS08	0,15A; 75V; szybkość <4ns	tape/reel
BAS32L	0,2A; 75V; ultra szybkość <4ns	tape/reel
BAV100	0,25A; 60V; szybkość <50ns	tape/reel
BAV101	0,25A; 120V; szybkość <50ns	tape/reel
BAV102	0,25A; 200V; szybkość <50ns	tape/reel
BAV103	0,25A; 250V; szybkość <50ns	tape/reel
RGL34D	0,5A; 200V; szybkość <150ns	tape/reel

## Obudowa DO213AB(MELF)

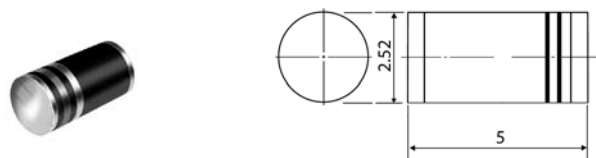

Symbol	Parametry	Rodzaj opakowania
SM4001	1A; 50V	tape/reel
SM4002	1A; 100V	tape/reel
SM4003	1A; 200V	tape/reel
SM4004	1A; 400V	tape/reel
SM4005	1A; 600V	tape/reel
SM4006	1A; 800V	tape/reel
SM4007	1A; 1000V	tape/reel
SM513	1A; 1300V	tape/reel
SM516	1A; 1600V	tape/reel
SM518	1A; 1800V	tape/reel
SM2000	1A; 2000V	tape/reel
BYM10-050	1A; 50V	tape/reel
BYM10-100	1A; 100V	tape/reel
BYM10-200	1A; 200V	tape/reel
BYM10-400	1A; 400V	tape/reel
BYM10-600	1A; 600V	tape/reel
BYM10-800	1A; 800V	tape/reel
BYM10-1000	1A; 1000V	tape/reel
BYM11-50	1A; 500V; szybka <150ns	tape/reel
BYM11-100	1A; 100V; szybka <150ns	tape/reel
BYM11-200	1A; 200V; szybka <150ns	tape/reel
BYM11-400	1A; 400V; szybka <150ns	tape/reel
BYM11-600	1A; 600V; szybka <250ns	tape/reel
BYM11-800	1A; 800V; szybka <500ns	tape/reel
BYM11-1000	1A; 1000V; szybka <500ns	tape/reel
BYM12-050	1A; 50V; ultra szybka <50ns	tape/reel
BYM12-100	1A; 100V; ultra szybka <50ns	tape/reel
BYM12-150	1A; 150V; ultra szybka <50ns	tape/reel
BYM12-200	1A; 200V; ultra szybka <50ns	tape/reel
BYM12-300	1A; 300V; ultra szybka <50ns	tape/reel
BYM12-400	1A; 400V; ultra szybka <50ns	tape/reel
SUF4001	1A; 50V; ultra szybka <50ns	tape/reel
SUF4002	1A; 100V; ultra szybka <50ns	tape/reel
SUF4003	1A; 200V; ultra szybka <50ns	tape/reel
SUF4004	1A; 400V; ultra szybka <50ns	tape/reel
SUF4005	1A; 600V; ultra szybka <50ns	tape/reel
SUF4006	1A; 800V; ultra szybka <50ns	tape/reel
SUF4007	1A; 1000V; ultra szybka <50ns	tape/reel
BYD37D	1,5A; 200V; szybka <250ns	tape/reel
BYD37G	1,5A; 400V; szybka <250ns	tape/reel
BYD37J	1,5A; 600V; szybka <250ns	tape/reel
BYD37K	1,5A; 800V; szybka <300ns	tape/reel
BYD37M	1,5A; 1000V; szybka <300ns	tape/reel
SM5400	3A; 50V	tape/reel
SM5401	3A; 100V	tape/reel
SM5402	3A; 200V	tape/reel
SM5403	3A; 300V	tape/reel
SM5404	3A; 400V	tape/reel
SM5405	3A; 500V	tape/reel
SM5406	3A; 600V	tape/reel
SM5407	3A; 800V	tape/reel
SM5408	3A; 1000V	tape/reel

## Obudowa DO41

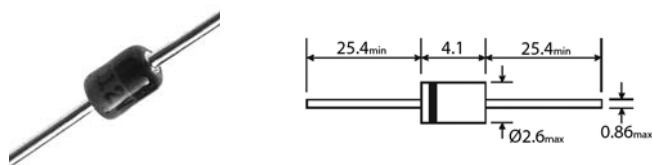

Symbol	Parametry	Rodzaj opakowania
BA157	1A; 400V; szybka <300ns	ammo
BA158	1A; 600V; szybka <300ns	ammo
BA159	1A; 1000V; szybka <300ns	ammo

## Obudowa TO92

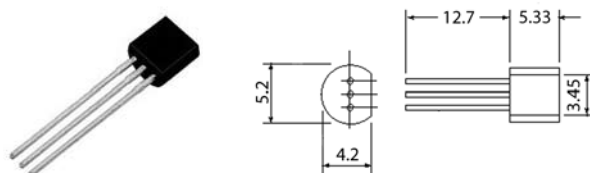

Symbol	Parametry	Rodzaj opakowania
J500	0,24mA; 50V	box
J501	0,33mA; 50V	box
J502	0,43mA; 50V	box
J503	0,56mA; 50V	box
J504	0,75mA; 50V	box
J505	1,0mA; 50V	box
J506	1,4mA; 50V	box
J507	1,8mA; 50V	box
J508	2,4mA; 50V	box
J509	3,0mA; 50V	box
J510	3,6mA; 50V	box
J511	4,7mA; 50V	box

## Obudowa DO35

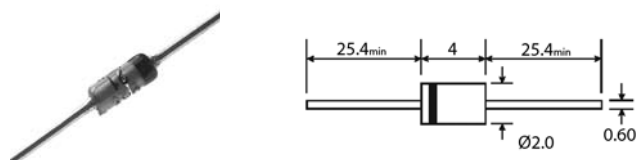

Symbol	Parametry	Rodzaj opakowania
BA479G	0,05A; 30V; 100Mhz Zr=5k ohm	ammo
BA479S	0,05A; 30V; 100Mhz Zr=9k ohm	ammo
1N4151	0,05A; 75V; szybka <2ns	ammo
BA482	0,1A; 35V; 1,2pF dla Vr=3V	ammo
BA483	0,1A; 35V; 1,0pF dla Vr=3V	ammo
BA484	0,1A; 35V; 1,6pF dla Vr=3V	ammo
1N4148	0,15A; 75V; szybka <4ns	ammo
1N4448	0,15A; 75V; szybka <4ns	ammo
BAS33	0,2A; 30V	ammo
BAS34	0,2A; 60V	ammo
1N914	0,2A; 75V; szybka <4ns	ammo
BAV19	0,2A; 120V; szybka <50ns	ammo
BAV20	0,2A; 200V; szybka <50ns	ammo
BAW62	0,25A; 75V; ultra szybka <4ns	ammo
BAV21	0,2A; 250V; szybka <50ns	ammo
1N4150	0,3A; 50V; szybka <4ns	ammo
BAV10	0,3A; 60V; ultra szybka <6ns	ammo
BAX14	0,5A; 20V; szybka <50ns	ammo
1N4149	0,5A; 100V	ammo

Pełne dane techniczne prezentowanych podzespołów  
dostępne są w naszym katalogu internetowym:  
**[www.micros.com.pl](http://www.micros.com.pl)**

# Diody prostownicze

## Obudowa DO213AA

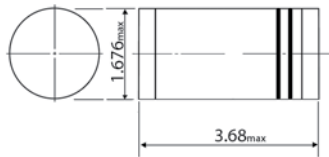

Symbol	Parametry	Rodzaj opakowania
EGL34A	0,5A; 50V; ultra szybka < 50ns	tape/reel
EGL34B	0,5A; 100V; ultra szybka < 50ns	tape/reel
EGL34C	0,5A; 150V; ultra szybka < 50ns	tape/reel
EGL34D	0,5A; 200V; ultra szybka < 50ns	tape/reel
EGL34F	0,5A; 300V; ultra szybka < 50ns	tape/reel
EGL34G	0,5A; 400V; ultra szybka < 50ns	tape/reel

## Obudowa DO213AB(MELF)

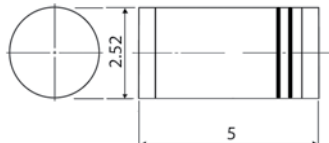

Symbol	Parametry	Rodzaj opakowania
SA154	1A; 50V	tape/reel
SA155	1A; 100V	tape/reel
SA156	1A; 200V	tape/reel
SA157	1A; 400V	tape/reel
SA158	1A; 600V	tape/reel
SA159	1A; 800V	tape/reel
SA160	1A; 1000V	tape/reel

## Obudowa SOD80

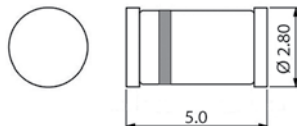

Symbol	Parametry	Rodzaj opakowania
GL1A	1A; 50V	tape/reel
GL1B	1A; 100V	tape/reel
GL1D	1A; 200V	tape/reel
GL1G	1A; 400V	tape/reel
GL1J	1A; 600V	tape/reel
GL1K	1A; 800V	tape/reel
GL1M	1A; 1000V	tape/reel
BYD17D	1,5A; 200V	tape/reel
BYD17G	1,5A; 400V	tape/reel
BYD17J	1,5A; 600V	tape/reel
BYD17K	1,5A; 800V	tape/reel
BYD17M	1,5A; 1000V	tape/reel

Pełne dane techniczne prezentowanych podzespołów dostępne są w naszym katalogu internetowym:  
[www.micros.com.pl](http://www.micros.com.pl)

## Obudowa DO214AC(SMA)

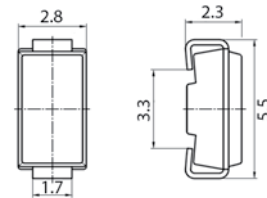
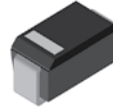

Symbol	Parametry	Rodzaj opakowania
S1A	1A; 50V	tape/reel
S1B	1A; 100V	tape/reel
S1D	1A; 200V	tape/reel
S1G	1A; 400V	tape/reel
S1J	1A; 600V	tape/reel
S1K	1A; 800V	tape/reel
S1M	1A; 1000V	tape/reel
RS1A	1A; 50V; szybka <150ns	tape/reel
RS1B	1A; 100V; szybka <150ns	tape/reel
RS1D	1A; 200V; szybka <150ns	tape/reel
RS1G	1A; 400V; szybka <150ns	tape/reel
RS1J	1A; 600V; szybka <250ns	tape/reel
RS1K	1A; 800V; szybka <500ns	tape/reel
RS1M	1A; 1000V; szybka <500ns	tape/reel
FR1A	1A; 50V; szybka <150ns	tape/reel
FR1B	1A; 100V; szybka <150ns	tape/reel
FR1D	1A; 200V; szybka <150ns	tape/reel
FR1G	1A; 400V; szybka <500ns	tape/reel
FR1J	1A; 600V; szybka <500ns	tape/reel
FR1K	1A; 800V; szybka <500ns	tape/reel
FR1M	1A; 1000V; szybka <500ns	tape/reel
US1A	1A; 50V; ultra szybka <50ns	tape/reel
US1B	1A; 100V; ultra szybka <50ns	tape/reel
US1D	1A; 200V; ultra szybka <50ns	tape/reel
US1G	1A; 400V; ultra szybka <50ns	tape/reel
US1J	1A; 600V; ultra szybka <75ns	tape/reel
US1K	1A; 800V; ultra szybka <75ns	tape/reel
US1M	1A; 1000V; ultra szybka <75ns	tape/reel
ES1A	1A; 50V; ultra szybka <15ns	tape/reel
ES1B	1A; 100V; ultra szybka <15ns	tape/reel
ES1C	1A; 150V; ultra szybka <15ns	tape/reel
ES1D	1A; 200V; ultra szybka <15ns	tape/reel
BYG26D	1A; 200V; ultra szybka <30ns	tape/reel
BYG26G	1A; 400V; ultra szybka <30ns	tape/reel
BYG26J	1A; 600V; ultra szybka <30ns	tape/reel
BYG10D	1.5A; 200V	tape/reel
BYG10G	1.5A; 400V	tape/reel
BYG10J	1.5A; 600V	tape/reel
BYG10K	1.5A; 800V	tape/reel
BYG10M	1.5A; 1000V	tape/reel
BYG10Y	1.5A; 1600V	tape/reel

## Obudowa DO214AA-SMB

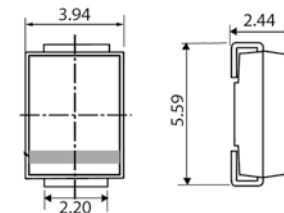

Symbol	Parametry	Rodzaj opakowania
S2A	1,5A; 50V	tape/reel
S2B	1,5A; 100V	tape/reel
S2D	1,5A; 200V	tape/reel
S2G	1,5A; 400V	tape/reel
S2J	1,5A; 600V	tape/reel
S2K	1,5A; 800V	tape/reel
S2M	1,5A; 1000V	tape/reel
FR2A	2A; 50V; szybka <150ns	tape/reel
FR2B	2A; 100V; szybka <150ns	tape/reel
FR2D	2A; 200V; szybka <150ns	tape/reel
FR2G	2A; 400V; szybka <150ns	tape/reel
FR2J	2A; 600V; szybka <250ns	tape/reel
FR2K	2A; 800V; szybka <500ns	tape/reel
FR2M	2A; 1000V; szybka <500ns	tape/reel
ES2A	2A; 50V; ultra szybka <20ns	tape/reel
ES2B	2A; 100V; ultra szybka <20ns	tape/reel
ES2C	2A; 150V; ultra szybka <20ns	tape/reel
ES2D	2A; 200V; ultra szybka <20ns	tape/reel
MURS105T3	1A/40AP; 50V; ultra szybka <35ns	tape/reel
MURS110T3	1A/40AP; 100V; ultra szybka <35ns	tape/reel
MURS115T3	1A/40AP; 150V; ultra szybka <35ns	tape/reel
MURS120T3	1A/40AP; 200V; ultra szybka <35ns	tape/reel
MURS120T3	1A/35AP; 400V; ultra szybka <35ns	tape/reel
MURS120T3	1A/35AP; 600V; ultra szybka <35ns	tape/reel

Obudowa DO214AB-SMC

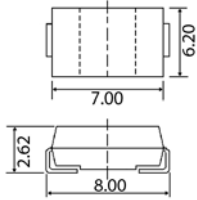

Symbol	Parametry	Rodzaj opakowania
S3A	3A; 50V	tape/reel
S3B	3A; 100V	tape/reel
S3D	3A; 200V	tape/reel
S3G	3A; 400V	tape/reel
S3J	3A; 600V	tape/reel
S3K	3A; 800V	tape/reel
S3M	3A; 1000V	tape/reel
FR3A	3A; 50V; szybkość <150ns	tape/reel
FR3B	3A; 100V; szybkość <150ns	tape/reel
FR3D	3A; 200V; szybkość <150ns	tape/reel
FR3G	3A; 400V; szybkość <150ns	tape/reel
FR3J	3A; 600V; szybkość <250ns	tape/reel
FR3K	3A; 800V; szybkość <500ns	tape/reel
FR3M	3A; 1000V; szybkość <500ns	tape/reel
US3A	3A; 50V; ultra szybkość <50ns	tape/reel
US3B	3A; 100V; ultra szybkość <50ns	tape/reel
US3D	3A; 200V; ultra szybkość <50ns	tape/reel
US3G	3A; 400V; ultra szybkość <50ns	tape/reel
US3J	3A; 600V; ultra szybkość <75ns	tape/reel
US3K	3A; 800V; ultra szybkość <75ns	tape/reel
US3M	3A; 1000V; ultra szybkość <75ns	tape/reel

Obudowa SOD57

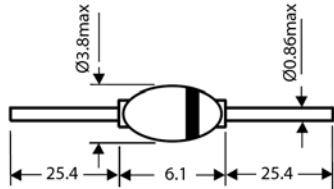

Symbol	Parametry	Rodzaj opakowania
BY203/12S	0,25A; 1200V	ammo
BY203/16S	0,25A; 1600V	ammo
BY203/20S	0,25A; 2000V	ammo
BYT52A	1A/20AP; 50V; szybkość <200ns	ammo
BYT52B	1A/20AP; 100V; szybkość <200ns	ammo
BYT52D	1A/20AP; 200V; szybkość <200ns	ammo
BYT52G	1A/20AP; 400V; szybkość <200ns	ammo
BYT52J	1A/20AP; 600V; szybkość <200ns	ammo
BYT52K	1A/20AP; 800V; szybkość <200ns	ammo
BYT52M	1A/20AP; 1000V; szybkość <200ns	ammo
BYV26A	1A; 200V; ultra szybkość <30ns	ammo
BYV26B	1A; 400V; ultra szybkość <30ns	ammo
BYV26C	1A; 600V; ultra szybkość <30ns	ammo
BYV26D	1A; 800V; ultra szybkość <30ns	ammo
BYV26E	1A; 1000V; ultra szybkość <75ns	ammo
BYV95A	1,5A; 200V; szybkość <250ns	ammo
BYV95B	1,5A; 400V; szybkość <250ns	ammo
BYV95C	1,5A; 600V; szybkość <250ns	ammo
BYV95D	1,5A; 800V; szybkość <300ns	ammo
BYV95E	1,5A; 1000V; szybkość <300ns	ammo
BYT53A	1,9A; 50V; ultra szybkość <50ns	ammo
BYT53B	1,9A; 100V; ultra szybkość <50ns	ammo
BYT53C	1,9A; 150V; ultra szybkość <50ns	ammo
BYT53D	1,9A; 200V; ultra szybkość <50ns	ammo
BYT53F	1,9A; 300V; ultra szybkość <50ns	ammo
BYT53G	1,9A; 400V; ultra szybkość <50ns	ammo
BYW52	2A; 200V	ammo
BYW53	2A; 400V	ammo
BYW54	2A; 600V	ammo
BYW55	2A; 800V	ammo
BYW56	2A; 1000V	ammo
BY458	2A; 1200V	ammo
BY448	2A; 1500V	ammo
BYW32	2A; 200V; szybkość <200ns	ammo
BYW33	2A; 300V; szybkość <200ns	ammo
BYW34	2A; 400V; szybkość <200ns	ammo
BYW35	2A; 500V; szybkość <200ns	ammo
BYW36	2A; 600V; szybkość <200ns	ammo
BYV27-50	2A; 50V; ultra szybkość <25ns	ammo
BYV27-100	2A; 100V; ultra szybkość <25ns	ammo
BYV27-150	2A; 150V; ultra szybkość <25ns	ammo
BYV27-200	2A; 200V; ultra szybkość <25ns	ammo
BYV27-300	2A; 300V; ultra szybkość <50ns	ammo
BYV27-400	2A; 400V; ultra szybkość <50ns	ammo
BYV27-500	2A; 500V; ultra szybkość <50ns	ammo
BYV27-600	2A; 600V; ultra szybkość <50ns	ammo

Obudowa DO41

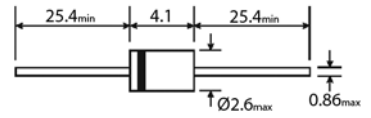

Symbol	Parametry	Rodzaj opakowania
GP02-20	0,25A; 2000V	ammo
GP02-25	0,25A; 2500V	ammo
GP02-30	0,25A; 3000V	ammo
GP02-35	0,25A; 3500V	ammo
GP02-40	0,25A; 4000V	ammo
RG02-12E	0,5A; 1200V; szybkość <300ns	ammo
RG02-14E	0,5A; 1400V; szybkość <300ns	ammo
RG02-16E	0,5A; 1600V; szybkość <300ns	ammo
RG02-18E	0,5A; 1800V; szybkość <300ns	ammo
RG02-20E	0,5A; 2000V; szybkość <300ns	ammo
1N4001	1A; 50V	ammo
1N4002	1A; 100V	ammo
1N4003	1A; 200V	ammo
1N4004	1A; 400V	ammo
1N4005	1A; 600V	ammo
1N4006	1A; 800V	ammo
1N4007	1A; 1000V	ammo
BY133	1A; 1300V	ammo
EM513	1A; 1600V	ammo
EM516	1A; 1800V	ammo
EM518	1A; 2000V	ammo
MUR105	1A; 50V	ammo
MUR110	1A; 100V	ammo
MUR115	1A; 150V	ammo
MUR120	1A; 200V	ammo
MUR130	1A; 300V	ammo
MUR140	1A; 400V	ammo
MUR160	1A; 600V	ammo
1N4933	1A; 50V; szybkość <200ns	ammo
1N4934	1A; 100V; szybkość <200ns	ammo
1N4935	1A; 200V; szybkość <200ns	ammo
1N4936	1A; 400V; szybkość <200ns	ammo
1N4937	1A; 600V; szybkość <200ns	ammo
FR101	1A; 50V; szybkość <150ns	ammo
FR102	1A; 100V; szybkość <150ns	ammo
FR103	1A; 200V; szybkość <150ns	ammo
FR104	1A; 400V; szybkość <150ns	ammo
FR105	1A; 600V; szybkość <250ns	ammo
FR106	1A; 800V; szybkość <500ns	ammo
FR107	1A; 1000V; szybkość <500ns	ammo
EGP10A	1A; 50V; ultra szybkość <50ns	ammo
EGP10B	1A; 100V; ultra szybkość <50ns	ammo
EGP10C	1A; 150V; ultra szybkość <50ns	ammo
EGP10D	1A; 200V; ultra szybkość <50ns	ammo
EGP10F	1A; 300V; ultra szybkość <50ns	ammo
EGP10G	1A; 400V; ultra szybkość <50ns	ammo
EGP10J	1A; 600V; ultra szybkość <75ns	ammo
EGP10K	1A; 800V; ultra szybkość <75ns	ammo
HER101	1A; 50V; ultra szybkość <50ns	ammo
HER102	1A; 100V; ultra szybkość <50ns	ammo
HER103	1A; 200V; ultra szybkość <50ns	ammo
HER105	1A; 400V; ultra szybkość <50ns	ammo
HER106	1A; 600V; ultra szybkość <75ns	ammo
HER107	1A; 800V; ultra szybkość <75ns	ammo
HER108	1A; 1000V; ultra szybkość <75ns	ammo
UF4001	1A; 50V; ultra szybkość <50ns	ammo
UF4002	1A; 100V; ultra szybkość <50ns	ammo
UF4003	1A; 200V; ultra szybkość <50ns	ammo
UF4004	1A; 400V; ultra szybkość <50ns	ammo
UF4005	1A; 600V; ultra szybkość <75ns	ammo
UF4006	1A; 800V; ultra szybkość <75ns	ammo
UF4007	1A; 1000V; ultra szybkość <75ns	ammo

## Obudowa SOD64

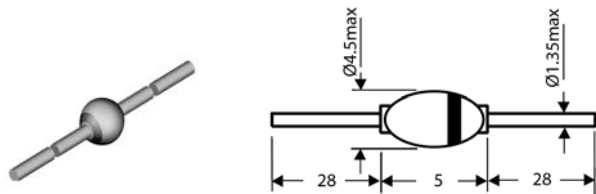

Symbol	Parametry	Rodzaj opakowania
BYM26A	2,3A; 200V; szybkość <30ns	ammo
BYM26B	2,3A; 400V; szybkość <30ns	ammo
BYM26C	2,3A; 600V; szybkość <30ns	ammo
BYM26D	2,3A; 800V; szybkość <75ns	ammo
BYM26E	2,3A; 1000V; szybkość <75ns	ammo
BYM26F	2,3A; 1200V; szybkość <150ns	ammo
BYM26G	2,3A; 1400V; szybkość <150ns	ammo
BYW72	3A; 200V; szybkość <200ns	ammo
BYW73	3A; 300V; szybkość <200ns	ammo
BYW74	3A; 400V; szybkość <200ns	ammo
BYW75	3A; 500V; szybkość <200ns	ammo
BYW76	3A; 600V; szybkość <200ns	ammo
BYW96D	3A; 800V; szybkość <300ns	ammo
BYW96E	3A; 1000V; szybkość <300ns	ammo
BY228	3A; 1500V	ammo
BYT56A	3A/80AP; 50V; szybkość <100ns	ammo
BYT56B	3A/80AP; 100V; szybkość <100ns	ammo
BYT56D	3A/80AP; 200V; szybkość <100ns	ammo
BYT56G	3A/80AP; 400V; szybkość <100ns	ammo
BYT56J	3A/80AP; 600V; szybkość <100ns	ammo
BYT56K	3A/80AP; 800V; szybkość <100ns	ammo
BYT56M	3A/80AP; 1000V; szybkość <100ns	ammo
BYV28-050	3,5A; 50V; ultra szybkość <30ns	ammo
BYV28-100	3,5A; 100V; ultra szybkość <30ns	ammo
BYV28/150	3,5A; 200V; ultra szybkość <30ns	ammo
BYV28/200	3,5A; 200V; ultra szybkość <75ns	ammo

## Obudowa DO-204AP

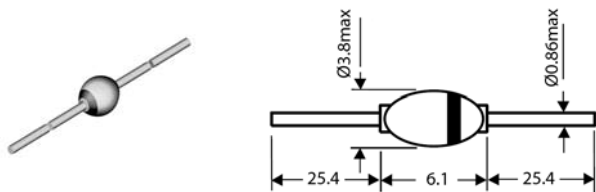

Symbol	Parametry	Rodzaj opakowania
BYV95A	1,5A; 200V; szybkość <250ns	ammo
BYV95B	1,5A; 400V; szybkość <250ns	ammo
BYV95C	1,5A; 600V; szybkość <250ns	ammo
BYV95D	1,5A; 800V; szybkość <300ns	ammo
BYV95E	1,5A; 1000V; szybkość <300ns	ammo

## Obudowa SOD81

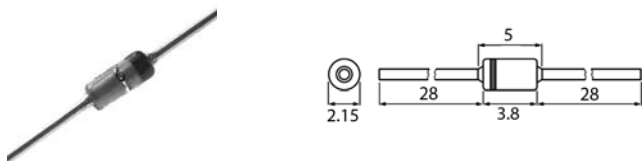

Symbol	Parametry	Rodzaj opakowania
BYD33D	1,3A; 200V; szybkość <250ns	ammo
BYD33G	1,3A; 400V; szybkość <250ns	ammo
BYD33J	1,3A; 600V; szybkość <250ns	ammo
BYD33K	1,3A; 800V; szybkość <300ns	ammo
BYD33M	1,3A; 1000V; szybkość <300ns	ammo
BYD33U	1,3A; 1200V; szybkość <500ns	ammo
BYD33V	1,3A; 1400V; szybkość <500ns	ammo

## Obudowa SOD91



Symbol	Parametry	Rodzaj opakowania
BAS11	0,35A; 300V	ammo
BAS12	0,35A; 400V	ammo

## Obudowa DO15

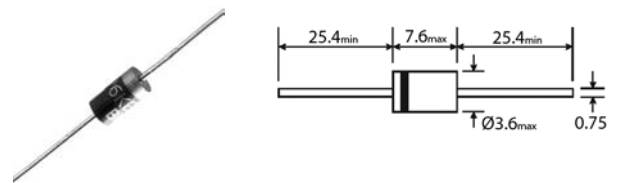

Symbol	Parametry	Rodzaj opakowania
BYT01-400	1A; 400V; ultra szybkość <25ns	ammo
1N5391	1,5A; 50V	ammo
1N5392	1,5A; 100V	ammo
1N5393	1,5A; 200V	ammo
1N5395	1,5A; 400V	ammo
1N5397	1,5A; 600V	ammo
1N5398	1,5A; 800V	ammo
1N5399	1,5A; 1000V	ammo
RGP15A	1,5A; 50V; szybkość <150ns	ammo
RGP15B	1,5A; 100V; szybkość <150ns	ammo
RGP15D	1,5A; 200V; szybkość <150ns	ammo
RGP15G	1,5A; 400V; szybkość <150ns	ammo
RGP15J	1,5A; 600V; szybkość <250ns	ammo
RGP15K	1,5A; 800V; szybkość <500ns	ammo
RGP15M	1,5A; 1000V; szybkość <500ns	ammo
BYW100-200	1,5A; 200V; ultra szybkość <30ns	ammo
1N5059	2A; 200V	ammo
1N5060	2A; 400V	ammo
1N5061	2A; 600V	ammo
1N5062	2A; 800V	ammo
FR201	2A; 50V; szybkość <150ns	ammo
FR202	2A; 100V; szybkość <150ns	ammo
FR203	2A; 200V; szybkość <150ns	ammo
FR204	2A; 400V; szybkość <150ns	ammo
FR205	2A; 600V; szybkość <250ns	ammo
FR206	2A; 800V; szybkość <500ns	ammo
FR207	2A; 1000V; szybkość <500ns	ammo
EGP20A	2A; 50V; ultra szybkość <50ns	ammo
EGP20B	2A; 100V; ultra szybkość <50ns	ammo
EGP20D	2A; 200V; ultra szybkość <50ns	ammo
EGP20F	2A; 300V; ultra szybkość <50ns	ammo
EGP20G	2A; 400V; ultra szybkość <50ns	ammo
EGP20J	2A; 600V; ultra szybkość <75ns	ammo
EGP20K	2A; 800V; ultra szybkość <75ns	ammo

## Obudowa DO27

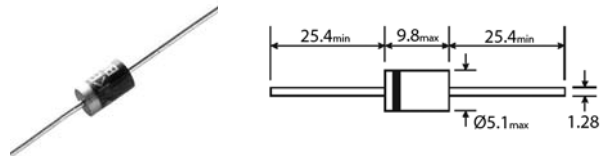

Symbol	Parametry	Rodzaj opakowania
1N5400	3A; 50V	ammo
1N5401	3A; 100V	ammo
1N5402	3A; 200V	ammo
1N5403	3A; 300V	ammo
1N5404	3A; 400V	ammo
1N5406	3A; 600V	ammo
1N5407	3A; 800V	ammo
1N5408	3A; 1000V	ammo
BY396	3A; 100V; szybkość <250ns	ammo
BY399	3A; 200V; szybkość <250ns	ammo
BY399	3A; 400V; szybkość <250ns	ammo
BY399	3A; 800V; szybkość <250ns	ammo
UF5400	3A; 50V; ultra szybkość <50ns	ammo
UF5401	3A; 100V; ultra szybkość <50ns	ammo
UF5402	3A; 200V; ultra szybkość <50ns	ammo
UF5403	3A; 300V; ultra szybkość <50ns	ammo
UF5404	3A; 400V; ultra szybkość <50ns	ammo
UF5405	3A; 500V; ultra szybkość <75ns	ammo
UF5406	3A; 600V; ultra szybkość <75ns	ammo
UF5407	3A; 800V; ultra szybkość <75ns	ammo
UF5408	3A; 1000V; ultra szybkość <75ns	ammo
MUR420	4A; 200V; ultra szybkość <25ns	ammo
MUR440	4A; 600V; ultra szybkość <50ns	ammo
MUR460	4A; 600V; ultra szybkość <50ns	ammo

## Obudowa R-6

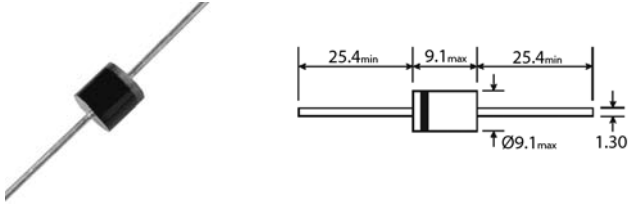

Symbol	Parametry	Rodzaj opakowania
6A05	6A; 50V	ammo
6A1	6A; 100V	ammo
6A2	6A; 200V	ammo
6A4	6A; 400V	ammo
6A6	6A; 600V	ammo
6A8	6A; 800V	ammo
6A10	6A; 1000V	ammo
FR601	6A; 50V; szybka <150ns	ammo
FR602	6A; 100V; szybka <150ns	ammo
FR603	6A; 200V; szybka <150ns	ammo
FR604	6A; 400V; szybka <150ns	ammo
FR605	6A; 600V; szybka <250ns	ammo
FR606	6A; 800V; szybka <500ns	ammo
FR607	6A; 1000V; szybka <500ns	ammo
UF600A	6A; 50V; ultra szybka <75ns	ammo
UF600B	6A; 100V; ultra szybka <75ns	ammo
UF600D	6A; 200V; ultra szybka <75ns	ammo
UF600G	6A; 400V; ultra szybka <75ns	ammo
UF600J	6A; 600V; ultra szybka <100ns	ammo
UF600K	6A; 800V; ultra szybka <100ns	ammo
UF600M	6A; 1000V; ultra szybka <100ns	ammo
10A05	10A; 50V	ammo
10A1	10A; 100V	ammo
10A2	10A; 200V	ammo
10A4	10A; 400V	ammo
10A6	10A; 600V	ammo
10A8	10A; 800V	ammo
10A10	10A; 1000V	ammo

## Obudowa DO201AD

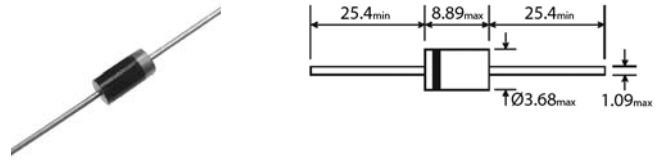

Symbol	Parametry	Rodzaj opakowania
BY296	2A; 100V	ammo
BY297	2A; 200V	ammo
BY298	2A; 400V	ammo
BY299	2A; 800V	ammo
BY251	3A; 200V	ammo
BY252	3A; 400V	ammo
BY253	3A; 600V	ammo
BY254	3A; 800V	ammo
BY255	3A; 1300V	ammo
BY1600	3A; 1600V	ammo
BY1800	3A; 1800V	ammo
BY2000	3A; 2000V	ammo
MR850	3A; 50V; szybka <100ns	ammo
MR851	3A; 100V; szybka <100ns	ammo
MR852	3A; 200V; szybka <100ns	ammo
MR854	3A; 400V; szybka <100ns	ammo
MR856	3A; 600V; szybka <150ns	ammo
MR858	3A; 8000V; szybka <150ns	ammo
RGP30A	3A; 50V; szybka <150ns	ammo
RGP30B	3A; 100V; szybka <150ns	ammo
RGP30D	3A; 200V; szybka <150ns	ammo
RGP30G	3A; 400V; szybka <150ns	ammo
RGP30J	3A; 600V; szybka <250ns	ammo
RGP30K	3A; 800V; szybka <500ns	ammo
RGP30M	3A; 1000V; szybka <500ns	ammo
BYW95A	3A; 200V; szybka <250ns	ammo
BYW95B	3A; 400V; szybka <250ns	ammo
BYW95C	3A; 600V; szybka <250ns	ammo
FR301	3A; 50V; szybka <150ns	ammo
FR302	3A; 100V; szybka <150ns	ammo
FR303	3A; 200V; szybka <150ns	ammo
FR304	3A; 400V; szybka <150ns	ammo
FR305	3A; 600V; szybka <250ns	ammo
FR306	3A; 800V; szybka <500ns	ammo
FR307	3A; 1000V; szybka <500ns	ammo
BYW98-200	3A; 200V; ultra szybka <35ns	ammo
BYT03-400	3A; 400V; ultra szybka <25ns	ammo
BY550-50	5A; 50V	ammo
BY550-100	5A; 100V	ammo
BY550-200	5A; 200V	ammo
BY550-400	5A; 400V	ammo
BY550-600	5A; 600V	ammo
BY550-800	5A; 800V	ammo
BY550-1000	5A; 1000V	ammo
BY500-50	5A; 50V; szybka <200ns	ammo
BY500-100	5A; 100V; szybka <200ns	ammo
BY500-200	5A; 200V; szybka <200ns	ammo
BY500-400	5A; 400V; szybka <200ns	ammo
BY500-600	5A; 600V; szybka <200ns	ammo
BY500-800	5A; 800V; szybka <200ns	ammo
BY500-1000	5A; 1000V; szybka <200ns	ammo
EGP50A	5A; 50V; ultra szybka <50ns	ammo
EGP50B	5A; 100V; ultra szybka <50ns	ammo
EGP50C	5A; 150V; ultra szybka <50ns	ammo
EGP50D	5A; 200V; ultra szybka <50ns	ammo
EGP50F	5A; 300V; ultra szybka <50ns	ammo
EGP50G	5A; 400V; ultra szybka <50ns	ammo

## Obudowa TO220FPAC



Symbol	Parametry	Rodzaj opakowania
BYW29FP-200	8A; 200V; ultra szybka <25ns	tube

## Obudowa TO-3P (TO-247AD)

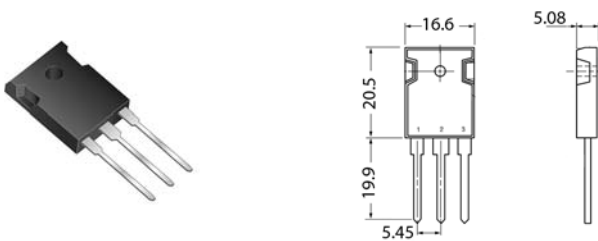

Symbol	Parametry	Rodzaj opakowania
BYV72EW-150	30A; 150V; ultra szybka <28ns	tube
BYV72EW-200	30A; 200V; ultra szybka <28ns	tube
FEP30AP	30A; 50V; ultra szybka <35ns	tube
FEP30BP	30A; 100V; ultra szybka <35ns	tube
FEP30CP	30A; 150V; ultra szybka <35ns	tube
FEP30DP	30A; 200V; ultra szybka <35ns	tube
FEP30FP	30A; 300V; ultra szybka <50ns	tube
FEP30GP	30A; 400V; ultra szybka <50ns	tube
FEP30HP	30A; 500V; ultra szybka <50ns	tube
FEP30JP	30A; 600V; ultra szybka <50ns	tube
DSEP30-03A	30A; 300V; ultra szybka <30ns	tube
DSEP30-04A	30A; 400V; ultra szybka <30ns	tube
DSEP30-06A	30A; 600V; ultra szybka <30ns	tube
DSEP30-12A	30A; 1200V; ultra szybka <40ns	tube
DSEP60-03A	60A; 300V; ultra szybka <30ns	tube
DSEP60-04A	60A; 400V; ultra szybka <30ns	tube
DSEP60-06A	60A; 600V; ultra szybka <35ns	tube
DSEP60-12A	60A; 1200V; ultra szybka <40ns	tube
DSEI60-06A	60A; 600V; ultra szybka <35ns	tube
DSEI60-12A	52A; 1200V; ultra szybka <40ns	tube

## Obudowa TO-247AC

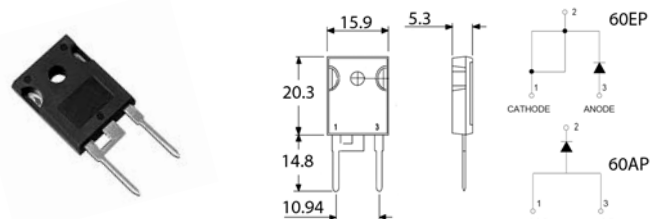

Symbol	Parametry	Rodzaj opakowania
60APU04PBF	60A; 400V; ultra szybka <50ns	tube
60EPU04PBF	60A; 400V; ultra szybka <50ns	tube



## Obudowa DO220

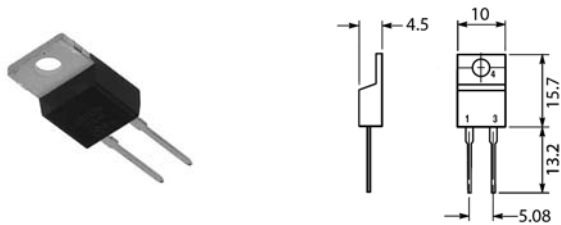

Symbol	Parametry	Rodzaj opakowania
BY229-200	7A; 200V	tube
BY229-400	7A; 400V	tube
BY229-600	7A; 600V	tube
BY229-800R	7A; 800V	tube
BYW29-50	8A; 50V; ultra szybka <25ns	tube
BYW29-100	8A; 100V; ultra szybka <25ns	tube
BYW29-150	8A; 150V; ultra szybka <25ns	tube
BYW29-200	8A; 200V; ultra szybka <25ns	tube
MUR820	8A; 200V; ultra szybka <25ns	tube
MUR840	8A; 400V; ultra szybka <50ns	tube
MUR860	8A; 600V; ultra szybka <50ns	tube
MUR880EG	8A; 800V; szybka <100ns	tube
MUR8100EG	8A; 1000V; szybka <100ns	tube
FES8AT	8A; 50V; ultra szybka <35ns	tube
FES8BT	8A; 100V; ultra szybka <35ns	tube
FES8CT	8A; 150V; ultra szybka <35ns	tube
FES8DT	8A; 200V; ultra szybka <35ns	tube
FES8FT	8A; 300V; ultra szybka <50ns	tube
FES8GT	8A; 400V; ultra szybka <50ns	tube
FES8HT	8A; 500V; ultra szybka <50ns	tube
FES8JT	8A; 600V; ultra szybka <50ns	tube
BYT08P-400	8A; 400V; ultra szybka <35ns	tube
BY329-800	8A; 800V; szybka <125ns	tube
BY329-1000	8A; 1000V; szybka <125ns	tube
BY329-1200	8A; 1200V; szybka <125ns	tube
BYT86-600	8A; 600V; szybka <150ns	tube
BYT86-800	8A; 800V; szybka <150ns	tube
BYT86-1000	8A; 1000V; szybka <150ns	tube
BYV29-300	9A; 300V; ultra szybka <50ns	tube
BYV29-400	9A; 400V; ultra szybka <50ns	tube
BYV29-500	9A; 500V; ultra szybka <50ns	tube
BY459-1500	10A; 1500V; szybka <350ns	tube
BY459-1500S	10A; 1500V; ultra szybka <220ns	tube
STTH12R06DIRG	12A; 600V; ultra szybka <25ns	tube
BYT12P-1000	12A; 1000V; szybka <220ns	tube
DSEI12-06A	14A; 600V; ultra szybka <35ns	tube
BYT79-300	14A; 300V; ultra szybka <60ns	tube
BYT79-400	14A; 400V; ultra szybka <60ns	tube
BYT79-500	14A; 500V; ultra szybka <60ns	tube
BYV79E-150	14A; 150V; ultra szybka <30ns	tube
BYV79E-200	14A; 200V; ultra szybka <30ns	tube
BYW81P-200	15A; 200V; ultra szybka <40ns	tube
HFA15TB60PBF	15A; 600V; ultra szybka <60ns	tube
DSEP12-12A	15A; 1200V; ultra szybka <40ns	tube
BY359-1500	15,7A; 1500V; szybka <600ns	tube
BY359-1500S	15,7A; 1500V; ultra szybka <350ns	tube
FES16AT	16A; 50V; ultra szybka <35ns	tube
FES16BT	16A; 100V; ultra szybka <35ns	tube
FES16CT	16A; 150V; ultra szybka <35ns	tube
FES16DT	16A; 200V; ultra szybka <35ns	tube
FES16FT	16A; 300V; ultra szybka <50ns	tube
FES16GT	16A; 400V; ultra szybka <50ns	tube
FES16HT	16A; 500V; ultra szybka <50ns	tube
FES16JT	16A; 600V; ultra szybka <50ns	tube
HFA25TB60PBF	25A; 600V; ultra szybka <75ns	tube
BYV42E-200	30A; 200V; ultra szybka <28ns	tube
BYT30PI-1000	30A; 1000V; ultra szybka <70ns	tube

## Obudowa SOT93

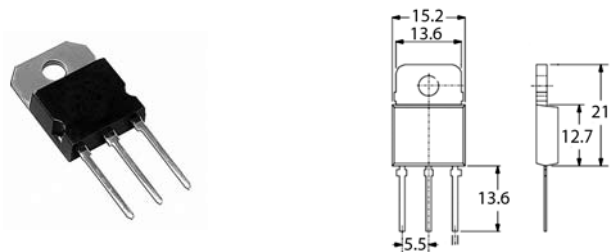

Symbol	Parametry	Rodzaj opakowania
BYV74-300	30A; 300V; ultra szybka <60ns	tube
BYV74-400	30A; 400V; ultra szybka <60ns	tube
BYV74-500	30A; 500V; ultra szybka <60ns	tube

## Obudowa TO220

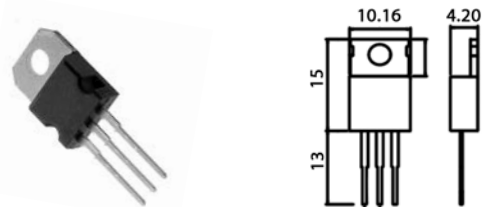

Symbol	Parametry	Rodzaj opakowania
DSEI12-12A	11A; 1200V; ultra szybka <50ns	tube
BYW51-150	16A; 150V; ultra szybka <35ns	tube
BYW51-200	16A; 200V; ultra szybka <35ns	tube
FEP16AT	16A; 50V; ultra szybka <35ns	tube
FEP16BT	16A; 100V; ultra szybka <35ns	tube
FEP16CT	16A; 150V; ultra szybka <35ns	tube
FEP16DT	16A; 200V; ultra szybka <35ns	tube
FEP16FT	16A; 300V; ultra szybka <50ns	tube
FEP16GT	16A; 400V; ultra szybka <50ns	tube
FEP16HT	16A; 500V; ultra szybka <50ns	tube
FEP16JT	16A; 600V; ultra szybka <50ns	tube
MUR1620CT	16A; 200V; ultra szybka <25ns	tube
MUR1640CT	16A; 400V; ultra szybka <50ns	tube
MUR1660CT	16A; 600V; ultra szybka <50ns	tube
BYV32-50	18A; 50V; ultra szybka <25ns	tube
BYV32-100	18A; 100V; ultra szybka <25ns	tube
BYV32-150	18A; 150V; ultra szybka <25ns	tube
BYV32-200	18A; 200V; ultra szybka <25ns	tube
BYV34-300 podwójna	20A; 300V; ultra szybka <60ns	tube
BYV34-400 podwójna	20A; 400V; ultra szybka <60ns	tube
BYV34-500 podwójna	20A; 500V; ultra szybka <60ns	tube
BYV42-150 podwójna	30A; 150V; ultra szybka <45ns	tube
BYV42-200 podwójna	30A; 200V; ultra szybka <45ns	tube

## Obudowa SOT227B

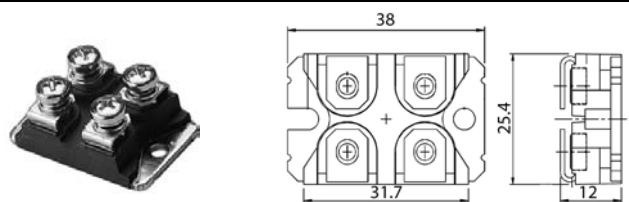

Symbol	Parametry	Rodzaj opakowania
DSEI2X101-06A	2x96A; 600V; szybka <35ns	box
DSEI2X121-02A	2x123A; 200V; szybka <35ns	box
DSEI2X31-06C	2x30A; 600V; szybka <35ns	box
DSEI2X61-12B	2x52A; 1200V; szybka <40ns	box

## Obudowa ISOTOP

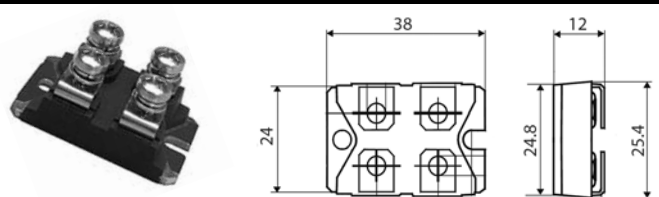

Symbol	Parametry	Rodzaj opakowania
BYV255V200	100A; 200V	box

Obudowa DO4

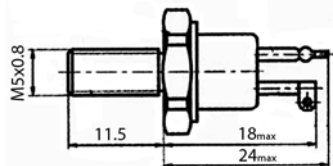

Symbol	Parametry	Rodzaj opakowania
D22-10-01	10A; 100V	box
D22-10-02	10A; 200V	box
D22-10-06	10A; 600V	box
D22-10-08	10A; 800V	box
D22-10-10	10A; 1000V	box
D22-10-12	10A; 1200V	box
D22-10-14	10A; 1400V	box
D22-10-16	10A; 1600V	box
D22-10R-01	10A; 100V; reverse	box
D22-10R-02	10A; 200V; reverse	box
D22-10R-06	10A; 600V; reverse	box
D22-10R-08	10A; 800V; reverse	box
D22-10R-10	10A; 1000V; reverse	box
D22-10R-12	10A; 1200V; reverse	box
D22-10R-14	10A; 1400V; reverse	box
D22-10R-16	10A; 1600V; reverse	box
D22-16-01	16A; 100V	box
D22-16-06	16A; 600V	box
D22-16-16	16A; 1600V	box
D22-16R-01	16A; 100V	box
D22-16R-06	16A; 600V; reverse	box
D22-16R-16	16A; 1600V; reverse	box
D22-20-08	20A; 800V	box
D22-20-12	20A; 1200V	box
D22-20R-08	20A; 800V; reverse	box
D22-20R-12	20A; 1200V; reverse	box
D22-25-06	25A; 600V	box
D22-25-08	25A; 800V	box
D22-25-10	25A; 1000V	box
D22-25-16	25A; 1600V	box
D22-25R-06	25A; 600V; reverse	box
D22-25R-08	25A; 800V; reverse	box
D22-25R-10	25A; 1000V; reverse	box
D22-25R-16	25A; 1600V; reverse	box

Obudowa DO8

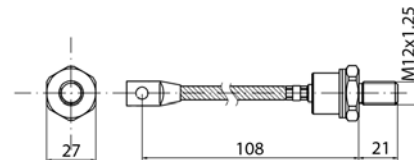

Symbol	Parametry	Rodzaj opakowania
D52-100-02	100A; 200V	box
D52-100-04	100A; 400V	box
D52-100-06	100A; 600V	box
D52-100-08	100A; 800V	box
D52-100-12	100A; 1200V	box
D52-100-14	100A; 1400V	box
D52-100R-02	100A; 200V; reverse	box
D52-100R-04	100A; 400V; reverse	box
D52-100R-06	100A; 600V; reverse	box
D52-100R-08	100A; 800V; reverse	box
D52-100R-12	100A; 1200V; reverse	box
D52-100R-14	100A; 1400V; reverse	box

Obudowa DO9

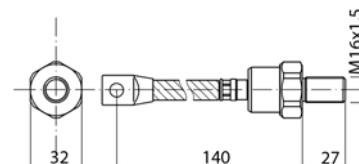

Symbol	Parametry	Rodzaj opakowania
D62-200-06	200A; 600V	box
D62-200-08	200A; 800V	box
D62-200R-06	200A; 600V; reverse	box
D62-200R-08	200A; 800V; reverse	box
D62-250-06	250A; 600V	box
D62-250R-06	250A; 600V; reverse	box
D62-250R-16	250A; 1600V; reverse	box
D62-300-12	300A; 1200V	box

Obudowa DO5

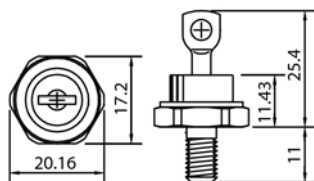

Symbol	Parametry	Rodzaj opakowania
D42-32-06	32A; 600V	box
D42-32-08	32A; 800V	box
D42-32-10	32A; 1000V	box
D42-32-12	32A; 1200V	box
D42-32R-06	32A; 600V; reverse	box
D42-32R-08	32A; 800V; reverse	box
D42-32R-10	32A; 1000V; reverse	box
D42-32R-12	32A; 1200V; reverse	box
D42-40-01	40A; 100V	box
D42-40-08	40A; 800V	box
D42-40-10	40A; 1000V	box
D42-40-12	40A; 1200V	box
D42-40R-01	40A; 100V; reverse	box
D42-40R-08	40A; 800V; reverse	box
D42-40R-10	40A; 1000V; reverse	box
D42-40R-12	40A; 1200V; reverse	box

Pełne dane techniczne prezentowanych podzespołów dostępne są w naszym katalogu internetowym:  
**www.micros.com.pl**

# Diody zabezpieczające (transile)

## Diody zabezpieczające 0,6kW jednokierunkowe DO15

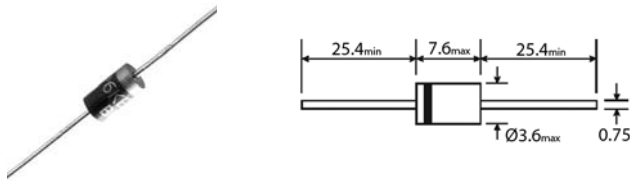

Symbol	Parametry	Rodzaj opakowania
P6KE6.8A	0,6kW; 6,8V; jednokierunkowa	ammo
P6KE8.2A	0,6kW; 8,2V; jednokierunkowa	ammo
P6KE10A	0,6kW; 10V; jednokierunkowa	ammo
P6KE12A	0,6kW; 12V; jednokierunkowa	ammo
P6KE15A	0,6kW; 15V; jednokierunkowa	ammo
P6KE18A	0,6kW; 18V; jednokierunkowa	ammo
P6KE20A	0,6kW; 20V; jednokierunkowa	ammo
P6KE27A	0,6kW; 27V; jednokierunkowa	ammo
P6KE30A	0,6kW; 30V; jednokierunkowa	ammo
P6KE33A	0,6kW; 33V; jednokierunkowa	ammo
P6KE36A	0,6kW; 36V; jednokierunkowa	ammo
P6KE43A	0,6kW; 43V; jednokierunkowa	ammo
P6KE47A	0,6kW; 47V; jednokierunkowa	ammo
P6KE51A	0,6kW; 51V; jednokierunkowa	ammo
P6KE68CA	0,6kW; 68V; jednokierunkowa	ammo
P6KE75A	0,6kW; 75V; jednokierunkowa	ammo
P6KE91A	0,6kW; 91V; jednokierunkowa	ammo
P6KE100A	0,6kW; 100V; jednokierunkowa	ammo
P6KE160A	0,6kW; 160V; jednokierunkowa	ammo
P6KE200A	0,6kW; 200V; jednokierunkowa	ammo
BZW06-5V8	0,6kW; 5,8V; jednokierunkowa	ammo
BZW06-23	0,6kW; 23,1V; jednokierunkowa	ammo

## Diody zabezpieczające 1,5kW DO27

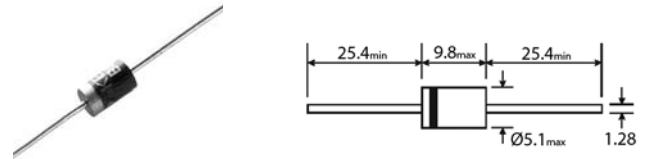

### jednokierunkowe

Symbol	Parametry	Rodzaj opakowania
1.5SMCJ5.0A	1,5kW; 5.0V	tape/reel
1.5SMCJ6.0A	1,5kW; 6.0V	tape/reel
1.5SMCJ6.5A	1,5kW; 6.5V	tape/reel
1.5SMCJ7.0A	1,5kW; 7.0V	tape/reel
1.5SMCJ7.5A	1,5kW; 7.5V	tape/reel
1.5SMCJ8.0A	1,5kW; 8.0V	tape/reel
1.5SMCJ8.5A	1,5kW; 8.5V	tape/reel
1.5SMCJ9.0A	1,5kW; 9.0V	tape/reel
1.5SMCJ10A	1,5kW; 10V	tape/reel
1.5SMCJ11A	1,5kW; 11V	tape/reel
1.5SMCJ12A	1,5kW; 12V	tape/reel
1.5SMCJ13A	1,5kW; 13V	tape/reel
1.5SMCJ14A	1,5kW; 14V	tape/reel
1.5SMCJ15A	1,5kW; 15V	tape/reel
1.5SMCJ16A	1,5kW; 16V	tape/reel
1.5SMCJ17A	1,5kW; 17V	tape/reel
1.5SMCJ18A	1,5kW; 18V	tape/reel
1.5SMCJ20A	1,5kW; 20V	tape/reel
1.5SMCJ22A	1,5kW; 22V	tape/reel
1.5SMCJ24A	1,5kW; 24V	tape/reel
1.5SMCJ26A	1,5kW; 26V	tape/reel
1.5SMCJ28A	1,5kW; 28V	tape/reel
1.5SMCJ30A	1,5kW; 30V	tape/reel
1.5SMCJ33A	1,5kW; 33V	tape/reel
1.5SMCJ36A	1,5kW; 36V	tape/reel
1.5SMCJ40A	1,5kW; 40V	tape/reel
1.5SMCJ43A	1,5kW; 43V	tape/reel
1.5SMCJ45A	1,5kW; 45V	tape/reel
1.5SMCJ48A	1,5kW; 48V	tape/reel
1.5SMCJ51A	1,5kW; 51V	tape/reel
1.5SMCJ54A	1,5kW; 54V	tape/reel
1.5SMCJ58A	1,5kW; 58V	tape/reel
1.5SMCJ60A	1,5kW; 60V	tape/reel
1.5SMCJ64A	1,5kW; 64V	tape/reel
1.5SMCJ70A	1,5kW; 70V	tape/reel
1.5SMCJ75A	1,5kW; 75V	tape/reel
1.5SMCJ78A	1,5kW; 78V	tape/reel
1.5SMCJ85A	1,5kW; 85V	tape/reel
1.5SMCJ90A	1,5kW; 90V	tape/reel
1.5SMCJ100A	1,5kW; 100V	tape/reel
1.5SMCJ110A	1,5kW; 110V	tape/reel
1.5SMCJ120A	1,5kW; 120V	tape/reel
1.5SMCJ130A	1,5kW; 130V	tape/reel
1.5SMCJ140A	1,5kW; 140V	tape/reel
1.5SMCJ150A	1,5kW; 150V	tape/reel
1.5SMCJ160A	1,5kW; 160V	tape/reel
1.5SMCJ170A	1,5kW; 170V	tape/reel
1.5SMCJ180A	1,5kW; 180V	tape/reel
1.5SMCJ190A	1,5kW; 190V	tape/reel
1.5SMCJ200A	1,5kW; 200V	tape/reel
1.5SMCJ210A	1,5kW; 210V	tape/reel
1.5SMCJ220A	1,5kW; 220V	tape/reel

### dwukierunkowe

Symbol	Parametry	Rodzaj opakowania
1.5SMCJ5.0CA	1,5kW; 5.0V	tape/reel
1.5SMCJ6.0CA	1,5kW; 6.0V	tape/reel
1.5SMCJ6.5CA	1,5kW; 6.5V	tape/reel
1.5SMCJ7.0CA	1,5kW; 7.0V	tape/reel
1.5SMCJ7.5CA	1,5kW; 7.5V	tape/reel
1.5SMCJ8.0CA	1,5kW; 8.0V	tape/reel
1.5SMCJ8.5CA	1,5kW; 8.5V	tape/reel
1.5SMCJ9.0CA	1,5kW; 9.0V	tape/reel
1.5SMCJ10CA	1,5kW; 10V	tape/reel
1.5SMCJ11CA	1,5kW; 11V	tape/reel
1.5SMCJ12CA	1,5kW; 12V	tape/reel
1.5SMCJ13CA	1,5kW; 13V	tape/reel
1.5SMCJ14CA	1,5kW; 14V	tape/reel
1.5SMCJ15CA	1,5kW; 15V	tape/reel
1.5SMCJ16CA	1,5kW; 16V	tape/reel
1.5SMCJ17CA	1,5kW; 17V	tape/reel
1.5SMCJ18CA	1,5kW; 18V	tape/reel
1.5SMCJ20CA	1,5kW; 20V	tape/reel
1.5SMCJ22CA	1,5kW; 22V	tape/reel
1.5SMCJ24CA	1,5kW; 24V	tape/reel
1.5SMCJ26CA	1,5kW; 26V	tape/reel
1.5SMCJ28CA	1,5kW; 28V	tape/reel
1.5SMCJ30CA	1,5kW; 30V	tape/reel
1.5SMCJ33CA	1,5kW; 33V	tape/reel
1.5SMCJ36CA	1,5kW; 36V	tape/reel
1.5SMCJ40CA	1,5kW; 40V	tape/reel
1.5SMCJ43CA	1,5kW; 43V	tape/reel
1.5SMCJ45CA	1,5kW; 45V	tape/reel
1.5SMCJ48CA	1,5kW; 48V	tape/reel
1.5SMCJ51CA	1,5kW; 51V	tape/reel
1.5SMCJ54CA	1,5kW; 54V	tape/reel
1.5SMCJ58CA	1,5kW; 58V	tape/reel
1.5SMCJ60CA	1,5kW; 60V	tape/reel
1.5SMCJ64CA	1,5kW; 64V	tape/reel
1.5SMCJ70CA	1,5kW; 70V	tape/reel
1.5SMCJ75CA	1,5kW; 75V	tape/reel
1.5SMCJ78CA	1,5kW; 78V	tape/reel
1.5SMCJ85CA	1,5kW; 85V	tape/reel
1.5SMCJ90CA	1,5kW; 90V	tape/reel
1.5SMCJ100CA	1,5kW; 100V	tape/reel
1.5SMCJ110CA	1,5kW; 110V	tape/reel
1.5SMCJ120CA	1,5kW; 120V	tape/reel
1.5SMCJ130CA	1,5kW; 130V	tape/reel
1.5SMCJ140CA	1,5kW; 140V	tape/reel
1.5SMCJ150CA	1,5kW; 150V	tape/reel
1.5SMCJ160CA	1,5kW; 160V	tape/reel
1.5SMCJ170CA	1,5kW; 170V	tape/reel
1.5SMCJ180CA	1,5kW; 180V	tape/reel
1.5SMCJ190CA	1,5kW; 190V	tape/reel
1.5SMCJ200CA	1,5kW; 200V	tape/reel
1.5SMCJ210CA	1,5kW; 210V	tape/reel
1.5SMCJ220CA	1,5kW; 220V	tape/reel

## Diody zabezpieczające 0,6kW dwukierunkowe DO15

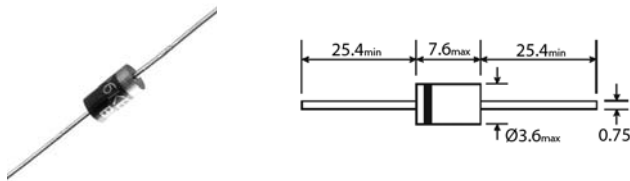

symbol	parametry	Rodzaj opakowania
P6KE6.8CA	0,6kW; 6,8V; dwukierunkowa	ammo
P6KE7.5CA	0,6kW; 7,5V; dwukierunkowa	ammo
P6KE8.2CA	0,6kW; 8,2V; dwukierunkowa	ammo
P6KE10CA	0,6kW; 10V; dwukierunkowa	ammo
P6KE11CA	0,6kW; 11V; dwukierunkowa	ammo
P6KE13CA	0,6kW; 13V; dwukierunkowa	ammo
P6KE15C	0,6kW; 15V; dwukierunkowa	ammo
P6KE15CA	0,6kW; 15V; dwukierunkowa	ammo
P6KE68CA	0,6kW; 68V; dwukierunkowa	ammo
P6KE16CA	0,6kW; 16V; dwukierunkowa	ammo
P6KE18CA	0,6kW; 18V; dwukierunkowa	ammo
P6KE27CA	0,6kW; 27V; dwukierunkowa	ammo
P6KE33CA	0,6kW; 33V; dwukierunkowa	ammo
P6KE36CA	0,6kW; 36V; dwukierunkowa	ammo
P6KE43CA	0,6kW; 43V; dwukierunkowa	ammo
P6KE47CA	0,6kW; 47V; dwukierunkowa	ammo
P6KE51CA	0,6kW; 51V; dwukierunkowa	ammo
P6KE62CA	0,6kW; 62V; dwukierunkowa	ammo
P6KE100CA	0,6kW; 100V; dwukierunkowa	ammo
P6KE180CA	0,6kW; 180V; dwukierunkowa	ammo
P6KE200CA	0,6kW; 200V; dwukierunkowa	ammo
P6KE440CA	0,6kW; 440V; dwukierunkowa	ammo
BZW06-13B	0,6kW; 12,8V; dwukierunkowa	ammo
BZW06-20	0,6kW; 20,5V; dwukierunkowa	ammo
BZW06-23B	0,6kW; 23,1V; dwukierunkowa	ammo

## Diody zabezpieczające SMBJ 0,6kW

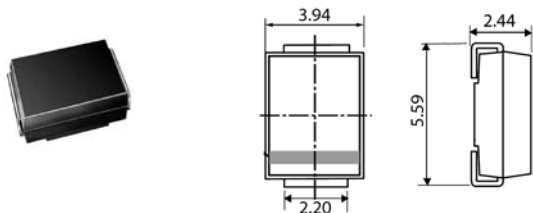

## Diody zabezpieczające SMCJ 1,5kW

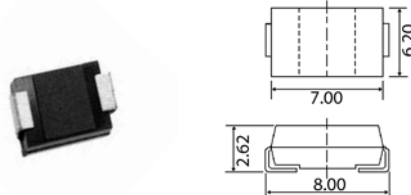

### jednokierunkowe

### dwukierunkowe

### jednokierunkowe

### dwukierunkowe

Symbol	Parametry	Rodzaj opakowania
SMBJ6.0A	0;6kW; 6.0V	tape/reel
SMBJ6.5A	0;6kW; 6.5V	tape/reel
SMBJ6.8A	0;6kW; 6.8V	tape/reel
SMBJ7.0A	0;6kW; 7.0V	tape/reel
SMBJ7.5A	0;6kW; 7.5V	tape/reel
SMBJ8.0A	0;6kW; 8.0V	tape/reel
SMBJ8.5A	0;6kW; 8.5V	tape/reel
SMBJ9.0A	0;6kW; 9.0V	tape/reel
SMBJ10A	0;6kW; 10V	tape/reel
SMBJ11A	0;6kW; 11V	tape/reel
SMBJ12A	0;6kW; 12V	tape/reel
SMBJ13A	0;6kW; 13V	tape/reel
SMBJ14A	0;6kW; 14V	tape/reel
SMBJ15A	0;6kW; 15V	tape/reel
SMBJ16A	0;6kW; 16V	tape/reel
SMBJ17A	0;6kW; 17V	tape/reel
SMBJ18A	0;6kW; 18V	tape/reel
SMBJ20A	0;6kW; 20V	tape/reel
SMBJ22A	0;6kW; 22V	tape/reel
SMBJ24A	0;6kW; 24V	tape/reel
SMBJ26A	0;6kW; 26V	tape/reel
SMBJ28A	0;6kW; 28V	tape/reel
SMBJ30A	0;6kW; 30V	tape/reel
SMBJ33A	0;6kW; 33V	tape/reel
SMBJ36A	0;6kW; 36V	tape/reel
SMBJ40A	0;6kW; 40V	tape/reel
SMBJ43A	0;6kW; 43V	tape/reel
SMBJ45A	0;6kW; 45V	tape/reel
SMBJ48A	0;6kW; 48V	tape/reel
SMBJ51A	0;6kW; 51V	tape/reel
SMBJ54A	0;6kW; 54V	tape/reel
SMBJ58A	0;6kW; 58V	tape/reel
SMBJ60A	0;6kW; 60V	tape/reel
SMBJ64A	0;6kW; 64V	tape/reel
SMBJ70A	0;6kW; 70V	tape/reel
SMBJ75A	0;6kW; 75V	tape/reel
SMBJ78A	0;6kW; 78V	tape/reel
SMBJ85A	0;6kW; 85V	tape/reel
SMBJ90A	0;6kW; 90V	tape/reel
SMBJ100A	0;6kW; 100V	tape/reel
SMBJ110A	0;6kW; 110V	tape/reel
SMBJ120A	0;6kW; 120V	tape/reel
SMBJ130A	0;6kW; 130V	tape/reel
SMBJ150A	0;6kW; 150V	tape/reel
SMBJ160A	0;6kW; 160V	tape/reel
SMBJ170A	0;6kW; 170V	tape/reel
SMBJ3V3	0;6kW; 100V	tape/reel

Symbol	Parametry	Rodzaj opakowania
SMBJ5.0CA	0;6kW; 5.0V	tape/reel
SMBJ6.0CA	0;6kW; 6.0CA	tape/reel
SMBJ6.5CA	0;6kW; 6.5V	tape/reel
SMBJ7.0CA	0;6kW; 7.0V	tape/reel
SMBJ7.5CA	0;6kW; 7.5V	tape/reel
SMBJ8.0CA	0;6kW; 8.0V	tape/reel
SMBJ8.5CA	0;6kW; 8.5V	tape/reel
SMBJ9.0CA	0;6kW; 9.0V	tape/reel
SMBJ10CA	0;6kW; 10V	tape/reel
SMBJ11CA	0;6kW; 11V	tape/reel
SMBJ12CA	0;6kW; 12V	tape/reel
SMBJ13CA	0;6kW; 13V	tape/reel
SMBJ14CA	0;6kW; 14V	tape/reel
SMBJ15CA	0;6kW; 15V	tape/reel
SMBJ16CA	0;6kW; 16V	tape/reel
SMBJ17CA	0;6kW; 17V	tape/reel
SMBJ18CA	0;6kW; 18V	tape/reel
SMBJ20CA	0;6kW; 20V	tape/reel
SMBJ22CA	0;6kW; 22V	tape/reel
SMBJ24CA	0;6kW; 24V	tape/reel
SMBJ26CA	0;6kW; 26V	tape/reel
SMBJ28CA	0;6kW; 28V	tape/reel
SMBJ30CA	0;6kW; 30V	tape/reel
SMBJ33CA	0;6kW; 33V	tape/reel
SMBJ36CA	0;6kW; 36V	tape/reel
SMBJ40CA	0;6kW; 40V	tape/reel
SMBJ43CA	0;6kW; 43V	tape/reel
SMBJ45CA	0;6kW; 45V	tape/reel
SMBJ48CA	0;6kW; 48V	tape/reel
SMBJ51CA	0;6kW; 51V	tape/reel
SMBJ54CA	0;6kW; 54V	tape/reel
SMBJ58CA	0;6kW; 58V	tape/reel
SMBJ60CA	0;6kW; 60V	tape/reel
SMBJ64CA	0;6kW; 64V	tape/reel
SMBJ70CA	0;6kW; 70V	tape/reel
SMBJ75CA	0;6kW; 75V	tape/reel
SMBJ78CA	0;6kW; 78V	tape/reel
SMBJ85CA	0;6kW; 85V	tape/reel
SMBJ90CA	0;6kW; 90V	tape/reel
SMBJ100CA	0;6kW; 100V	tape/reel
SMBJ110CA	0;6kW; 110V	tape/reel
SMBJ120CA	0;6kW; 120V	tape/reel
SMBJ130CA	0;6kW; 130V	tape/reel
SMBJ150CA	0;6kW; 150V	tape/reel
SMBJ160CA	0;6kW; 160V	tape/reel
SMBJ170CA	0;6kW; 170V	tape/reel

Symbol	Parametry	Rodzaj opakowania
1.5SMCJ5.0A	1;5kW; 5.0V	tape/reel
1.5SMCJ6.0A	1;5kW; 6.0V	tape/reel
1.5SMCJ6.5A	1;5kW; 6.5V	tape/reel
1.5SMCJ7.0A	1;5kW; 7.0V	tape/reel
1.5SMCJ7.5A	1;5kW; 7.5V	tape/reel
1.5SMCJ8.0A	1;5kW; 8.0V	tape/reel
1.5SMCJ8.5A	1;5kW; 8.5V	tape/reel
1.5SMC6.8A	1;5kW; 6.8V	tape/reel
1.5SMCJ39A	1;5kW; 39V	tape/reel
1.5SMCJ9.0A	1;5kW; 9.0V	tape/reel
1.5SMCJ10A	1;5kW; 10V	tape/reel
1.5SMCJ11A	1;5kW; 11V	tape/reel
1.5SMCJ12A	1;5kW; 12V	tape/reel
1.5SMCJ13A	1;5kW; 13V	tape/reel
1.5SMCJ14A	1;5kW; 14V	tape/reel
1.5SMCJ15A	1;5kW; 15V	tape/reel
1.5SMCJ16A	1;5kW; 16V	tape/reel
1.5SMCJ17A	1;5kW; 17V	tape/reel
1.5SMCJ18A	1;5kW; 18V	tape/reel
1.5SMCJ20A	1;5kW; 20V	tape/reel
1.5SMCJ22A	1;5kW; 22V	tape/reel
1.5SMCJ24A	1;5kW; 24V	tape/reel
1.5SMCJ26A	1;5kW; 26V	tape/reel
1.5SMCJ28A	1;5kW; 28V	tape/reel
1.5SMCJ30A	1;5kW; 30V	tape/reel
1.5SMCJ33A	1;5kW; 33V	tape/reel
1.5SMCJ36A	1;5kW; 36V	tape/reel
1.5SMCJ40A	1;5kW; 40V	tape/reel
1.5SMCJ43A	1;5kW; 43V	tape/reel
1.5SMCJ45A	1;5kW; 45V	tape/reel
1.5SMCJ48A	1;5kW; 48V	tape/reel
1.5SMCJ51A	1;5kW; 51V	tape/reel
1.5SMCJ54A	1;5kW; 54V	tape/reel
1.5SMCJ58A	1;5kW; 58V	tape/reel
1.5SMCJ60A	1;5kW; 60V	tape/reel
1.5SMCJ64A	1;5kW; 64V	tape/reel
1.5SMCJ70A	1;5kW; 70V	tape/reel
1.5SMCJ75A	1;5kW; 75V	tape/reel
1.5SMCJ78A	1;5kW; 78V	tape/reel
1.5SMCJ85A	1;5kW; 85V	tape/reel
1.5SMCJ90A	1;5kW; 90V	tape/reel
1.5SMCJ100A	1;5kW; 100V	tape/reel
1.5SMCJ110A	1;5kW; 110V	tape/reel
1.5SMCJ120A	1;5kW; 120V	tape/reel
1.5SMCJ130A	1;5kW; 130V	tape/reel
1.5SMCJ150A	1;5kW; 150V	tape/reel
1.5SMCJ160A	1;5kW; 160V	tape/reel
1.5SMCJ170A	1;5kW; 170V	tape/reel
1.5SMCJ180A	1;5kW; 180V	tape/reel
1.5SMCJ190A	1;5kW; 190V	tape/reel
1.5SMCJ200A	1;5kW; 200V	tape/reel
1.5SMCJ210A	1;5kW; 210V	tape/reel
1.5SMCJ220A	1;5kW; 220V	tape/reel

Symbol	Parametry	Rodzaj opakowania
1.5SMCJ5.0CA	1;5kW; 5.0V	tape/reel
1.5SMCJ6.0CA	1;5kW; 6.0V	tape/reel
1.5SMCJ6.5CA	1;5kW; 6.5V	tape/reel
1.5SMCJ7.0CA	1;5kW; 7.0V	tape/reel
1.5SMCJ7.5CA	1;5kW; 7.5V	tape/reel
1.5SMCJ8.0CA	1;5kW; 8.0V	tape/reel
1.5SMCJ8.5CA	1;5kW; 8.5V	tape/reel
1.5SMCJ9.0CA	1;5kW; 9.0V	tape/reel
1.5SMCJ10CA	1;5kW; 10V	tape/reel
1.5SMCJ11CA	1;5kW; 11V	tape/reel
1.5SMCJ12CA	1;5kW; 12V	tape/reel
1.5SMCJ13CA	1;5kW; 13V	tape/reel
1.5SMCJ14CA	1;5kW; 14V	tape/reel
1.5SMCJ15CA	1;5kW; 15V	tape/reel
1.5SMCJ16CA	1;5kW; 16V	tape/reel
1.5SMCJ17CA	1;5kW; 17V	tape/reel
1.5SMCJ18CA	1;5kW; 18V	tape/reel
1.5SMCJ20CA	1;5kW; 20V	tape/reel
1.5SMCJ22CA	1;5kW; 22V	tape/reel
1.5SMCJ24CA	1;5kW; 24V	tape/reel
1.5SMCJ26CA	1;5kW; 26V	tape/reel
1.5SMCJ28CA	1;5kW; 28V	tape/reel
1.5SMCJ30CA	1;5kW; 30V	tape/reel
1.5SMCJ33CA	1;5kW; 33V	tape/reel
1.5SMCJ36CA	1;5kW; 36V	tape/reel
1.5SMCJ40CA	1;5kW; 40V	tape/reel
1.5SMCJ43CA	1;5kW; 43V	tape/reel
1.5SMCJ45CA	1;5kW; 45V	tape/reel
1.5SMCJ48CA	1;5kW; 48V	tape/reel
1.5SMCJ51CA	1;5kW; 51V	tape/reel
1.5SMCJ54CA	1;5kW; 54V	tape/reel
1.5SMCJ58CA	1;5kW; 58V	tape/reel
1.5SMCJ60CA	1;5kW; 60V	tape/reel
1.5SMCJ64CA	1;5kW; 64V	tape/reel
1.5SMCJ70CA	1;5kW; 70V	tape/reel
1.5SMCJ75CA	1;5kW; 75V	tape/reel
1.5SMCJ78CA	1;5kW; 78V	tape/reel
1.5SMCJ85CA	1;5kW; 85V	tape/reel
1.5SMCJ90CA	1;5kW; 90V	tape/reel
1.5SMCJ100CA	1;5kW; 100V	tape/reel
1.5SMCJ110CA	1;5kW; 110V	tape/reel
1.5SMCJ120CA	1;5kW; 120V	tape/reel
1.5SMCJ130CA	1;5kW; 130V	tape/reel
1.5SMCJ140CA	1;5kW; 140V	tape/reel
1.5SMCJ150CA	1;5kW; 150V	tape/reel
1.5SMCJ160CA	1;5kW; 160V	tape/reel
1.5SMCJ170CA	1;5kW; 170V	tape/reel
1.5SMCJ180CA	1;5kW; 180V	tape/reel
1.5SMCJ190CA	1;5kW; 190V	tape/reel
1.5SMCJ200CA	1;5kW; 200V	tape/reel
1.5SMCJ210CA	1;5kW; 210V	tape/reel
1.5SMCJ220CA	1;5kW; 220V	tape/reel

Pełne dane techniczne prezentowanych podzespołów  
dostępne są w naszym katalogu internetowym:

[www.micros.com.pl](http://www.micros.com.pl)

# Diody Schottky'ego

## Obudowa DO214AC-SMA

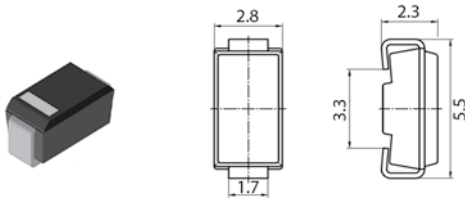

Symbol	Parametry	Rodzaj opakowania
B140	1A; 40V	tape/reel
MBRS140T3	1A; 40V	tape/reel
MBRS190	1A; 90V	tape/reel
SS12	1A; 20V	tape/reel
SS14	1A; 40V	tape/reel
SS16	1A; 60V	tape/reel
SS18	1A; 80V	tape/reel
SS110	1A; 100V	tape/reel
BYS10-45	1.5A; 45V	tape/reel
BYS11-90	1.5A; 90V	tape/reel
BYS12-90	1.5A; 90V	tape/reel
10MQ100N	1.5A; 100V	tape/reel

## Obudowa CASE403 (SMC)

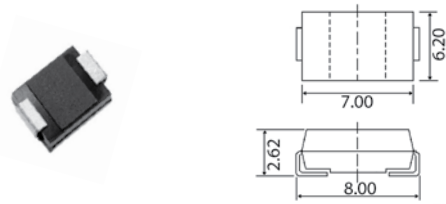

Symbol	Parametry	Rodzaj opakowania
MBRS340T	3A; 40V	tape/reel
MBRS360T3	3A; 60V	tape/reel

## Obudowa DO216AA(CASE457)

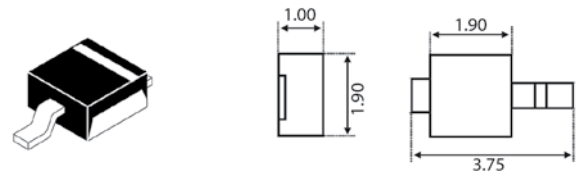

Symbol	Parametry	Rodzaj opakowania
MBRM140T	1A; 40V	tape/reel

## Obudowa DO214AA-SMB

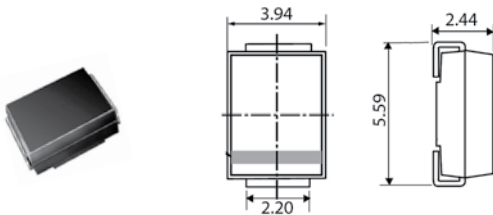

Symbol	Parametry	Rodzaj opakowania
10BQ040	1A; 40V	tape/reel
20BQ030	2A; 30V	tape/reel
STPS2L40U	2A; 40V	tape/reel
SS22	2A; 20V	tape/reel
SS23	2A; 30V	tape/reel
SS24	2A; 40V	tape/reel
SS25	2A; 50V	tape/reel
SS26	2A; 60V	tape/reel
SS28	2A; 80V	tape/reel
SS210	2A; 100V	tape/reel

## Obudowa SOT343

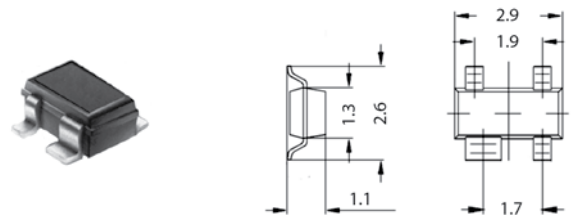

Symbol	Parametry	Rodzaj opakowania
BAT63	0,1A; 8V	tape/reel

## Obudowa DO214AB-SMC

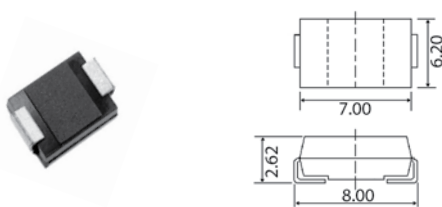

Symbol	Parametry	Rodzaj opakowania
30BQ040	3A; 40V	tape/reel
STPS340S	3A; 40V	tape/reel
SK36	3A; 60V	tape/reel
SS32	3A; 20V	tape/reel
SS33	3A; 30V	tape/reel
SS34	3A; 40V	tape/reel
SS35	3A; 50V	tape/reel
SS36	3A; 60V	tape/reel
SS38	3A; 80V	tape/reel
SS310	3A; 100V	tape/reel
SK42	4A; 20V	tape/reel
SK43	4A; 30V	tape/reel
SK44	4A; 40V	tape/reel
SK45	4A; 50V	tape/reel
SK46	4A; 60V	tape/reel
SK48	4A; 80V	tape/reel
SK410	4A; 100V	tape/reel
SK52	5A; 20V	tape/reel
SK53	5A; 30V	tape/reel
SK54	5A; 40V	tape/reel
SK55	5A; 50V	tape/reel
SK56	5A; 60V	tape/reel
SK58	5A; 80V	tape/reel
SK510	5A; 100V	tape/reel

## Obudowa SOD123

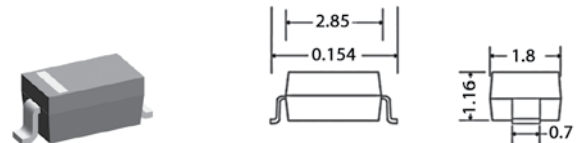

Symbol	Parametry	Rodzaj opakowania
SD103CW	0,2A; 20V	tape/reel
MBR0520	0,5A; 20V	tape/reel
MBR0530T1	0,5A; 30V	tape/reel
MBR0540	0,5A; 40V	tape/reel

## Obudowa SOD110

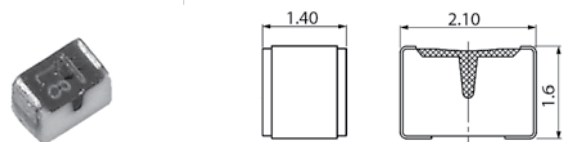

Symbol	Parametry	Rodzaj opakowania
BAS216	0,25mA; 75V; ultra szybka <4ns	tape/reel
BAT254	0,2A; 30V	tape/reel

## Obudowa SOD81



Symbol	Parametry	Rodzaj opakowania
BYV10-20	1A; 20V	ammo
BYV10-30	1A; 30V	ammo
BYV10-40	1A; 40V	ammo

Obudowa SOT23

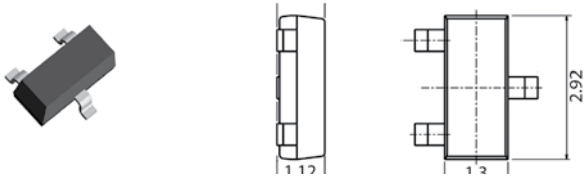

Symbol	Parametry	Rodzaj opakowania
BAT17	0,03A; 4V	tape/reel
BAR43	0,1A; 30V; ultra szybka <5ns	tape/reel
BAR43A	0,1A; 30V; ultra szybka <5ns; wspólna anoda	tape/reel
BAR43C	0,1A; 30V; ultra szybka <5ns; wspólna katoda	tape/reel
BAR43S	0,1A; 30V; ultra szybka <5ns; wspólnie połączone	tape/reel
BAS40	0,12A; 40V	tape/reel
BAT54	0,2A; 30V	tape/reel
BAT54A	0,2A; 30V	tape/reel
BAT54C	0,2A; 30V	tape/reel
BAT54S	0,2A; 30V	tape/reel
BAT64-06	0,25A; 40V	tape/reel
1PS70SB20	0,5A; 40V	tape/reel
HSMS-8101	75mW; 4V; do pracy przy 10-14GHz	tape/reel

Obudowa SOD80



Symbol	Parametry	Rodzaj opakowania
BAS81	0,15A; 40V	tape/reel
BAS82	0,15A; 50V	tape/reel
BAS83	0,15A; 60V	tape/reel
LL46	0,15A; 100V	tape/reel
TMMBAT46	0,15A; 100V	tape/reel
LL103C	0,2A; 20V; ultra szybka <10ns	tape/reel
LL103B	0,2A; 30V; ultra szybka <10ns	tape/reel
TMMBAT43	0,2A; 30V	tape/reel
BAS85-GS08	0,2A; 30V	tape/reel
LL43	0,2A; 30V	tape/reel
LL103A	0,2A; 40V; ultra szybka <10ns	tape/reel
BAS86	0,2A; 50V	tape/reel

Obudowa DO213AB(MELF)

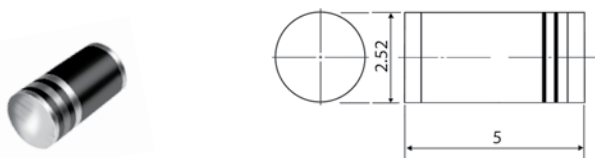

Symbol	Parametry	Rodzaj opakowania
1N5819M	1A; 40V	tape/reel
TMMBAT48	1A; 40V; szybka <10ns	tape/reel
TMBAT49	0,5A; 80V	tape/reel
LL5817	1A; 20V	tape/reel
LL5818	1A; 30V	tape/reel
LL5819	1A; 40V	tape/reel

Obudowa DO15

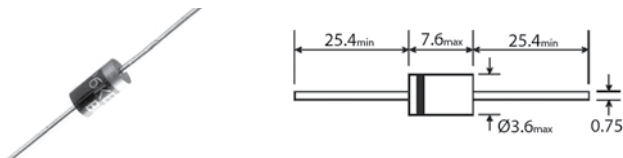

Symbol	Parametry	Rodzaj opakowania
BYS21-45	1A; 45V	ammo
BYS21-90	1A; 90V	ammo
BYS22-45	1,7A; 45V	ammo
SB2100	2A; 100V	ammo
SF21G	2A; 50V	ammo
SF22G	2A; 100V	ammo
SF23G	2A; 150V	ammo
SF24G	2A; 200V	ammo
SF25G	2A; 300V	ammo
SF26G	2A; 400V	ammo
SF27G	2A; 500V	ammo
SF28G	2A; 600V	ammo

Obudowa DO35

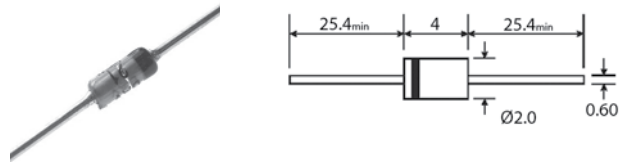

Symbol	Parametry	Rodzaj opakowania
1N6263	0,015A; 60V	ammo
1N5711	0,015A; 70V	ammo
BAT81	0,03A; 40V; 1ns	ammo
BAT81S	0,03A; 40V	ammo
BAT82S	0,03A; 50V	ammo
BAT83S	0,03A; 60V	ammo
BAT41	0,1A; 100V	ammo
BAT46	0,15A; 100V	ammo
BAT42	0,2A; 30V	ammo
BAT43	0,2A; 30V	ammo
BAT85	0,2A; 30V; 5ns	ammo
BAT85S	0,2A (max 5A); 30V	ammo
BAT86	0,2A ; 50V	ammo
BAT86S	0,2A (max 5A); 50V	ammo
BAT48	0,35A; 40V; szybka <10ns	ammo
BAT49	0,5A; 80V	ammo

Obudowa DO41

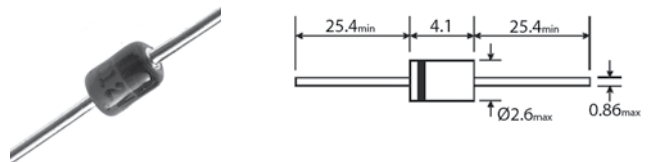

Symbol	Parametry	Rodzaj opakowania
1N5817	1A; 20V	ammo
1N5818	1A; 30V	ammo
1N5819	1A; 40V	ammo
SB120	1A; 20V	ammo
SB130	1A; 30V	ammo
SB140	1A; 40V	ammo
SB150	1A; 50V	ammo
SB160	1A; 60V	ammo
SR120	1A; 20V	ammo
SR130	1A; 30V	ammo
SR140	1A; 40V	ammo
SR150	1A; 50V	ammo
SR160	1A; 60V	ammo
SR180	1A; 80V	ammo
SR1100	1A; 100V	ammo
MBR1100	1A; 100V	ammo
STPS2H100	2A; 100V	ammo
MBR3060RL	3A; 60V	ammo

Obudowa DO201AD

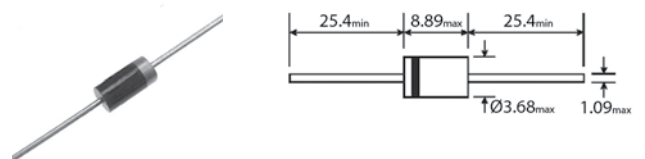

Symbol	Parametry	Rodzaj opakowania
1N5821	3A; 30V	ammo
1N5822	3A; 40V	ammo
BYS26-45	3A; 45V	ammo
SB3H100	3A; 100V	ammo
SB3100	3A; 100V	ammo
SB320	3A; 20V	ammo
SB330	3A; 30V	ammo
SB340	3A; 40V	ammo
SB350	3A; 50V	ammo
SB360	3A; 60V	ammo
MBR360	3A; 60V	ammo
SB390	3A; 90V	ammo
SB520	5A; 20V	ammo
SB530	5A; 30V	ammo
SB540	5A; 40V	ammo
SB550	5A; 50V	ammo
SB560	5A; 60V	ammo
SB590	5A; 90V	ammo
SB5100	5A; 100V	ammo

## Obudowa DO220

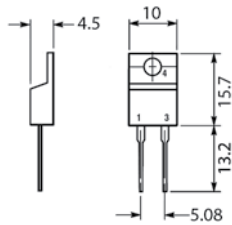
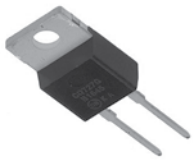

Symbol	Parametry	Rodzaj opakowania
MBR735	7,5A; 35V	tube
MBR745	7,5A; 45V	tube
MBR750	7,5A; 50V	tube
MBR760	7,5A; 60V	tube
MBR1035	10A; 35V	tube
STPS1045D	10A; 45V	tube
MBR1045	10A; 45V	tube
MBR1050	10A; 50V	tube
MBR1060	10A; 60V	tube
MBR10100	10A; 100V	tube
MBR1635	16A; 35V	tube
MBR1645	16A; 45V	tube
MBR1650	16A; 50V	tube
MBR1660	16A; 60V	tube

## Obudowa TO 3P

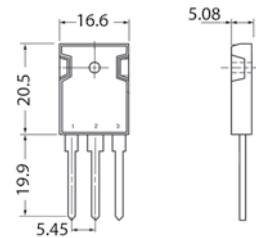
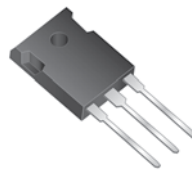

Symbol	Parametry	Rodzaj opakowania
MBR3035PT	30A; 35V	tube
MBR3045PT	30A; 45V	tube
MBR3050PT	30A; 50V	tube
MBR3060PT	30A; 60V	tube
MBR4035PT	40A; 35V	tube
MBR4045PT	40A; 45V	tube
MBR4050PT	40A; 50V	tube
MBR4060PT	40A; 60V	tube

## Obudowa TO220

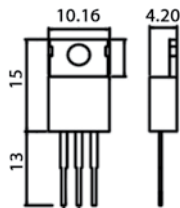

Symbol	Parametry	Rodzaj opakowania
SR1060	10A; 60V	tube
STPS20H100CT	10A; 100V	tube
10CTQ150	10A; 150V	tube
MBR1535	15A; 35V	tube
MBR1545	15A; 45V	tube
MBR1550	15A; 50V	tube
MBR1560	15A; 60V	tube
18TQ035PBF	18A; 35V	tube
18TQ040PBF	18A; 40V	tube
18TQ045PBF	18A; 45V	tube
18TQ050PBF	18A; 50V	tube
MBR2035CT	20A; 35V	tube
MBR2045CT	20A; 45V	tube
MBR2050CT	20A; 50V	tube
MBR2060CT	20A; 60V	tube
MBR2090CT	20A; 90V	tube
MBR20100CT	20A; 100V	tube
MBR20150CT	20A; 150V	tube
MBR20200CT	20A; 200V	tube
MBR2535CT	30A; 35V	tube
MBR2545CT	30A; 45V	tube
MBR2550CT	30A; 50V	tube
MBR2560CT	30A; 60V	tube

## Obudowa TO252

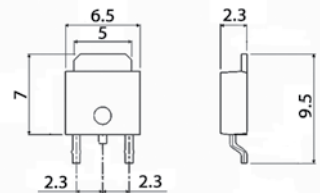

Symbol	Parametry	Rodzaj opakowania
12CWQ04FN	12A; 40V	tube

## Obudowa TO262

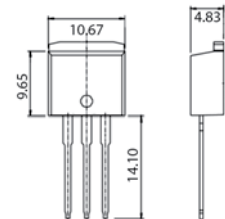

Symbol	Parametry	Rodzaj opakowania
MBR1545CT-1	15A; 45V	tube

## Obudowa TO263

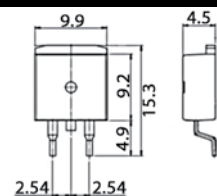

Symbol	Parametry	Rodzaj opakowania
MBRB1560CT	15A; 60V	tube

## Obudowa SOT93

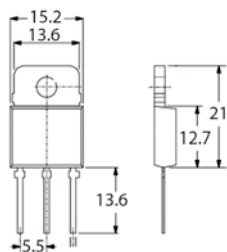

Symbol	Parametry	Rodzaj opakowania
STPS3045CP	30A; 45V	tube

## Obudowa TO247AC

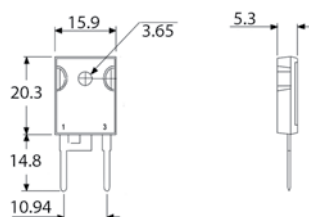

Symbol	Parametry	Rodzaj opakowania
40CPQ080PBF	40A; 80V	tube
40CPQ100PBF	40A; 100V	tube

Pełne dane techniczne prezentowanych podzespołów  
dostępne są w naszym katalogu internetowym:

[www.micros.com.pl](http://www.micros.com.pl)

Diody Zenera SMD SOT23 0,35W

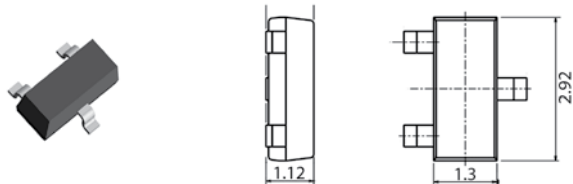

Symbol	Parametry	Rodzaj opakowania
BZX84C2V7	0,35W; 2,7V	tape/reel
BZX84C3V0	0,35W; 3,0V	tape/reel
BZX84C3V3	0,35W; 3,3V	tape/reel
BZX84C3V6	0,35W; 3,6V	tape/reel
BZX84C3V9	0,35W; 3,9V	tape/reel
BZX84C4V3	0,35W; 4,3V	tape/reel
BZX84C4V7	0,35W; 4,7V	tape/reel
BZX84C5V1	0,35W; 5,1V	tape/reel
BZX84C5V6	0,35W; 5,6V	tape/reel
BZX84C6V2	0,35W; 6,2V	tape/reel
BZX84C6V8	0,35W; 6,8V	tape/reel
BZX84C7V5	0,35W; 7,5V	tape/reel
BZX84C8V2	0,35W; 8,2V	tape/reel
BZX84C9V1	0,35W; 9,1V	tape/reel
BZX84C10	0,35W; 10V	tape/reel
BZX84C11	0,35W; 11V	tape/reel

Symbol	Parametry	Rodzaj opakowania
BZX84C12	0,35W; 12V	tape/reel
BZX84C13	0,35W; 13V	tape/reel
BZX84C15	0,35W; 15V	tape/reel
BZX84C16	0,35W; 16V	tape/reel
BZX84C18	0,35W; 18V	tape/reel
BZX84C20	0,35W; 20V	tape/reel
BZX84C22	0,35W; 22V	tape/reel
BZX84C24	0,35W; 24V	tape/reel
BZX84C27	0,35W; 27V	tape/reel
BZX84C30	0,35W; 30V	tape/reel
BZX84C33	0,35W; 33V	tape/reel
BZX84C36	0,35W; 36V	tape/reel
BZX84C39	0,35W; 39V	tape/reel
BZX84C43	0,35W; 43V	tape/reel
BZX84C47	0,35W; 47V	tape/reel
BZX84C51	0,35W; 51V	tape/reel

Diody Zenera 0,5W

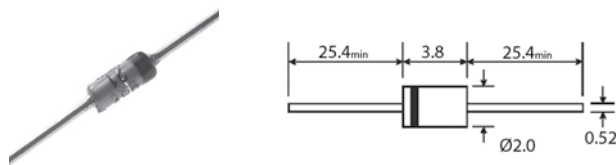

Symbol	Parametry	Rodzaj opakowania
BZX55C0V8	0,5W; 0,8V	ammo
BZX55C2V4	0,5W; 2,4V	ammo
BZX55C2V7	0,5W; 2,7V	ammo
BZX55C3V0	0,5W; 3V	ammo
BZX55C3V3	0,5W; 3,3V	ammo
BZX55C3V6	0,5W; 3,6V	ammo
BZP683C3V6	0,4W; 3,6V	ammo
BZX55C3V9	0,5W; 3,9V	ammo
BZX55C4V3	0,5W; 4,3V	ammo
BZX55C4V7	0,5W; 4,7V	ammo
BZX55C5V1	0,5W; 5,1V	ammo
BZX55C5V6	0,5W; 5,6V	ammo
BZX55C6V2	0,5W; 6,2V	ammo
BZX55C6V8	0,5W; 6,8V	ammo
BZX55C7V5	0,5W; 7,5V	ammo
BZX55C8V2	0,5W; 8,2V	ammo
BZX55C9V1	0,5W; 9,1V	ammo
BZX55C10	0,5W; 10V	ammo
BZX55C11	0,5W; 11V	ammo
BZX55C12	0,5W; 12V	ammo

Symbol	Parametry	Rodzaj opakowania
BZX55C13	0,5W; 13V	ammo
BZX55C15	0,5W; 15V	ammo
BZX55C16	0,5W; 16V	ammo
BZX55C18	0,5W; 18V	ammo
BZX55C20	0,5W; 20V	ammo
BZX55C22	0,5W; 22V	ammo
BZX55C24	0,5W; 24V	ammo
BZX55C27	0,5W; 27V	ammo
BZX55C30	0,5W; 30V	ammo
BZX55C33	0,5W; 33V	ammo
BZX55C36	0,5W; 36V	ammo
BZX55C39	0,5W; 39V	ammo
BZX55C43	0,5W; 43V	ammo
BZX55C47	0,5W; 47V	ammo
BZX55C51	0,5W; 51V	ammo
BZX55C56	0,5W; 56V	ammo
BZX55C62	0,5W; 62V	ammo
BZX55C68	0,5W; 68V	ammo
BZX55C75	0,5W; 75V	ammo

Diody Zenera 0,4W

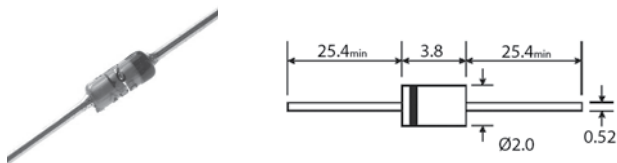

Symbol	Parametry	Rodzaj opakowania
BZX79C2V4	0,4W; 2,4V	ammo
BZX79C2V7	0,4W; 2,7V	ammo
BZX79C3V0	0,4W; 3,0V	ammo
BZX79C3V3	0,4W; 3,3V	ammo
BZX79C3V6	0,4W; 3,6V	ammo
BZX79C3V9	0,4W; 3,9V	ammo
BZX79C4V3	0,4W; 4,3V	ammo
BZX79C4V7	0,4W; 4,7V	ammo
BZX79C5V1	0,4W; 5,1V	ammo
BZX79C5V6	0,4W; 5,6V	ammo
BZX79C6V2	0,4W; 6,2V	ammo
BZX79C6V8	0,4W; 6,8V	ammo
BZX79C7V5	0,4W; 7,5V	ammo
BZX79C8V2	0,4W; 8,2V	ammo
BZX79C9V1	0,4W; 9,1V	ammo
BZX79C10	0,4W; 10V	ammo
BZX79C11	0,4W; 11V	ammo
BZX79C12	0,4W; 12V	ammo
BZX79C13	0,4W; 13V	ammo
BZX79C14	0,4W; 14V	ammo
BZX79C16	0,4W; 16V	ammo
BZX79C18	0,4W; 18V	ammo
BZX79C20	0,4W; 20V	ammo

Symbol	Parametry	Rodzaj opakowania
BZX79C22	0,4W; 22V	ammo
BZX79C24	0,4W; 24V	ammo
BZX79C27	0,4W; 27V	ammo
BZX79C30	0,4W; 30V	ammo
BZX79C33	0,4W; 18V	ammo
BZX79C36	0,4W; 36V	ammo
BZX79C39	0,4W; 39V	ammo
BZX79C43	0,4W; 43V	ammo
BZX79C47	0,4W; 47V	ammo
BZX79C51	0,4W; 51V	ammo
BZX79C56	0,4W; 56V	ammo
BZX79C62	0,4W; 62V	ammo
BZX79C68	0,4W; 68V	ammo
BZX79C75	0,4W; 75V	ammo
BZX79C82	0,4W; 82V	ammo
BZX79C91	0,4W; 91V	ammo
BZX79C100	0,4W; 100V	ammo
BZX79C110	0,4W; 110V	ammo
BZX79C120	0,4W; 120V	ammo
BZX79C130	0,4W; 130V	ammo
BZX79C150	0,4W; 150V	ammo
BZX79C160	0,4W; 160V	ammo
BZX79C180	0,4W; 180V	ammo

Diody Zenera SMD SOD80 0,5W

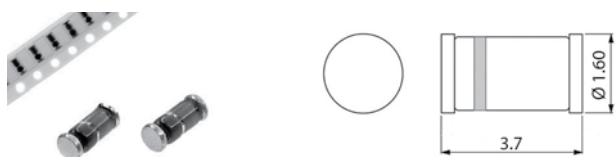

Symbol	Parametry	Rodzaj opakowania
BZV55C2V4	0,5W; 2,4V	tape/reel
BZV55B2V4	0,5W; 2,4V; 2%	tape/reel
BZV55C2V7	0,5W; 2,7V	tape/reel
BZV55B2V7	0,5W; 2,7V; 2%	tape/reel
BZV55C3V0	0,5W; 3V	tape/reel
BZV55B3V0	0,5W; 3V; 2%	tape/reel
BZV55C3V3	0,5W; 3,3V	tape/reel
BZV55B3V3	0,5W; 3,3V; 2%	tape/reel
BZV55C3V6	0,5W; 3,6V	tape/reel
BZV55B3V6	0,5W; 3,6V; 2%	tape/reel
BZV55C3V9	0,5W; 3,9V	tape/reel
BZV55B3V9	0,5W; 3,9V; 2%	tape/reel
BZV55C4V3	0,5W; 4,3V	tape/reel
BZV55B4V3	0,5W; 4,3V; 2%	tape/reel
BZV55C4V7	0,5W; 4,7V	tape/reel
BZV55B4V7	4,7V; 0,5W; 2%	tape/reel
BZV55C5V1	0,5W; 5,1V	tape/reel
BZV55B5V1	0,5W; 5,1V; 2%	tape/reel
BZV55C5V6	0,5W; 5,6V	tape/reel
BZV55B5V6	0,5W; 5,6V; 2%	tape/reel
BZV55C6V2	0,5W; 6,2V	tape/reel
BZV55B6V2	0,5W; 6,2V; 2%	tape/reel
BZV55C6V8	0,5W; 6,8V	tape/reel
BZV55B6V8	0,5W; 6,8V; 2%	tape/reel
BZV55C7V5	0,5W; 7,5V	tape/reel
BZV55B7V5	0,5W; 7,5V; 2%	tape/reel
BZV55C8V2	0,5W; 8,2V	tape/reel
BZV55B8V2	0,5W; 8,2V; 2%	tape/reel
BZV55C9V1	0,5W; 9,1V	tape/reel
BZV55B9V1	0,5W; 9,1V; 2%	tape/reel
BZV55C10	0,5W; 10V	tape/reel
BZV55B10	0,5W; 10V; 2%	tape/reel
BZV55C11	0,5W; 11V	tape/reel
BZV55B11	0,5W; 11V; 2%	tape/reel

Symbol	Parametry	Rodzaj opakowania
BZV55C12	0,5W; 12V	tape/reel
BZV55B12	0,5W; 12V; 2%	tape/reel
BZV55C13	0,5W; 13V	tape/reel
BZV55B13	0,5W; 13V; 2%	tape/reel
BZV55C15	0,5W; 15V	tape/reel
BZV55B15	0,5W; 15V; 2%	tape/reel
BZV55C16	0,5W; 16V	tape/reel
BZV55B16	0,5W; 16V; 2%	tape/reel
BZV55C18	0,5W; 18V	tape/reel
BZV55B18	0,5W; 18V; 2%	tape/reel
BZV55C20	0,5W; 20V	tape/reel
BZV55B20	0,5W; 20V; 2%	tape/reel
BZV55C22	0,5W; 22V	tape/reel
BZV55B22	0,5W; 22V; 2%	tape/reel
BZV55C24	0,5W; 24V	tape/reel
BZV55B24	0,5W; 24V; 2%	tape/reel
BZV55C27	0,5W; 27V	tape/reel
BZV55B27	0,5W; 27V; 2%	tape/reel
BZV55C30	0,5W; 30V	tape/reel
BZV55B30	0,5W; 30V; 2%	tape/reel
BZV55C33	0,5W; 33V	tape/reel
BZV55B33	0,5W; 33V; 2%	tape/reel
BZV55C36	0,5W; 36V	tape/reel
BZV55B36	0,5W; 36V; 2%	tape/reel
BZV55C39	0,5W; 39V	tape/reel
BZV55B39	0,5W; 39V; 2%	tape/reel
BZV55C43	0,5W; 43V	tape/reel
BZV55B43	0,5W; 43V; 2%	tape/reel
BZV55C47	0,5W; 47V	tape/reel
BZV55B47	0,5W; 47V; 2%	tape/reel
BZV55C51	0,5W; 51V	tape/reel
BZV55B51	0,5W; 51V; 2%	tape/reel
BZV55C56	0,5W; 56V	tape/reel
BZV55B56	0,5W; 56V; 2%	tape/reel



## Diody Zenera SMD MELF 1W

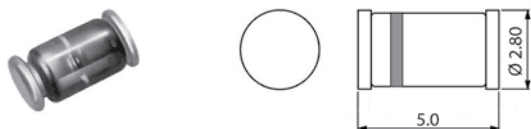

Symbol	Parametry	Rodzaj opakowania
DL4728A	1W; 3,3V	tape/reel
DL4729A	1W; 3,6V	tape/reel
DL4730A	1W; 3,9V	tape/reel
DL4731A	1W; 4,3V	tape/reel
DL4732A	1W; 4,7V	tape/reel
DL4733A	1W; 5,1V	tape/reel
DL4734A	1W; 5,6V	tape/reel
DL4735A	1W; 6,2V	tape/reel
DL4736A	1W; 6,8V	tape/reel
DL4737A	1W; 7,5V	tape/reel
DL4738A	1W; 8,2V	tape/reel
DL4739A	1W; 9,1V	tape/reel
DL4740A	1W; 10V	tape/reel
DL4741A	1W; 11V	tape/reel
DL4742A	1W; 12V	tape/reel
DL4743A	1W; 13V	tape/reel
DL4744A	1W; 15V	tape/reel
DL4745A	1W; 16V	tape/reel
DL4746A	1W; 18V	tape/reel
DL4747A	1W; 20V	tape/reel
DL4748A	1W; 22V	tape/reel
DL4749A	1W; 24V	tape/reel
DL4750A	1W; 27V	tape/reel
DL4751A	1W; 30V	tape/reel
DL4752A	1W; 33V	tape/reel
DL4753A	1W; 36V	tape/reel
DL4754A	1W; 39V	tape/reel

## Diody Zenera 1,3W

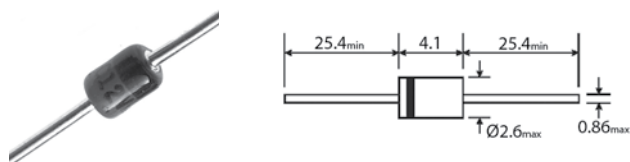

Symbol	Parametry	Rodzaj opakowania
BZX85C3V3	1,3W; 3,3V	ammo
BtZX85C3V6	1,3W; 3,6V	ammo
BZX85C3V9	1,3W; 3,9V	ammo
BZX85C4V3	1,3W; 4,3V	ammo
BZX85C4v7	1,3W; 4,7V	ammo
BZX85C5V1	1,3W; 5,1V	ammo
BZX85C5V6	1,3W; 5,6V	ammo
BZX85C6V2	1,3W; 6,2V	ammo
BZX85C6V8	1,3W; 6,8V	ammo
BZX85C7V5	1,3W; 7,5V	ammo
BZX85C8V2	1,3W; 8,2V	ammo
BZX85C9V1	1,3W; 9,1V	ammo
BZX85C10	1,3W; 10V	ammo
BZX85C11	1,3W; 11V	ammo
BZX85C12	1,3W; 12V	ammo
BZX85C13	1,3W; 13V	ammo
BZX85C15	1,3W; 15V	ammo
BZX85C16	1,3W; 16V	ammo
BZX85C18	1,3W; 18V	ammo
BZX85C20	1,3W; 20V	ammo
BZX85C22	1,3W; 22V	ammo
BZX85C24	1,3W; 24V	ammo
BZX85C27	1,3W; 27V	ammo
BZX85C30	1,3W; 30V	ammo
BZX85C33	1,3W; 33V	ammo
BZX85C36	1,3W; 36V	ammo
BZX85C43	1,3W; 43V	ammo
BZX85C47	1,3W; 47V	ammo
BZX85C51	1,3W; 51V	ammo
BZX85C56	1,3W; 56V	ammo
BZX85C62	1,3W; 62V	ammo
BZX85C68	1,3W; 68V	ammo
BZX85C75	1,3W; 75V	ammo
BZX85C82	1,3W; 82V	ammo
BZX85C91	1,3W; 91V	ammo
BZX85C100	1,3W; 100V	ammo
BZX85C110	1,3W; 110V	ammo
BZX85C120	1,3W; 120V	ammo
BZX85C130	1,3W; 130V	ammo
BZX85C150	1,3W; 150V	ammo
BZX85C160	1,3W; 160V	ammo
BZX85C180	1,3W; 180V	ammo
BZX85C200	1,3W; 200V	ammo
BZX85C91	1,3W; 91V	ammo
BZX85C9V1	1,3W; 9,1V	ammo
ZPY20	1,3W; 20V	ammo
ZPY22	1,3W; 22V	ammo
ZPY4V7	1,3W; 4,7V	ammo

## Diody Zenera 3W

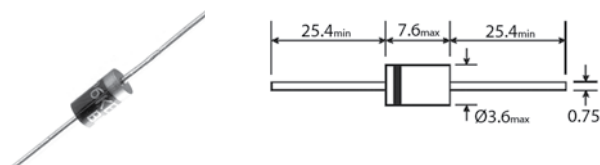

Symbol	Parametry	Rodzaj opakowania
3EZ11	3W; 11V	ammo
3EZ12	3W; 12V	ammo
3EZ13	3W; 13V	ammo
3EZ14	3W; 14V	ammo
3EZ15	3W; 15V	ammo
3EZ16	3W; 16V	ammo
3EZ17	3W; 17V	ammo
3EZ18	3W; 18V	ammo
3EZ19	3W; 19V	ammo
3EZ20	3W; 20V	ammo
3EZ22	3W; 22V	ammo
3EZ24	3W; 24V	ammo
3EZ27	3W; 27V	ammo
3EZ28	3W; 28V	ammo
3EZ30	3W; 30V	ammo
3EZ33	3W; 33V	ammo
3EZ36	3W; 36V	ammo
3EZ39	3W; 39V	ammo

## Diody Zenera SMD DO214AA 3W

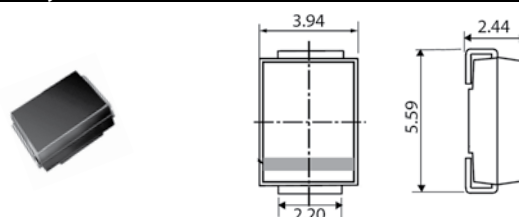

Symbol	Parametry	Rodzaj opakowania
SMB3EZ11	3W; 11V	tape/reel
SMB3EZ12	3W; 12V	tape/reel
SMB3EZ13	3W; 13V	tape/reel
SMB3EZ14	3W; 14V	tape/reel
SMB3EZ15	3W; 15V	tape/reel
SMB3EZ16	3W; 16V	tape/reel
SMB3EZ17	3W; 17V	tape/reel
SMB3EZ18	3W; 18V	tape/reel
SMB3EZ19	3W; 19V	tape/reel
SMB3EZ20	3W; 20V	tape/reel
SMB3EZ22	3W; 22V	tape/reel
SMB3EZ24	3W; 24V	tape/reel
SMB3EZ27	3W; 27V	tape/reel
SMB3EZ28	3W; 28V	tape/reel
SMB3EZ30	3W; 30V	tape/reel
SMB3EZ33	3W; 33V	tape/reel
SMB3EZ36	3W; 36V	tape/reel
SMB3EZ39	3W; 39V	tape/reel

## Diody Zenera SMD DO214AC 3W

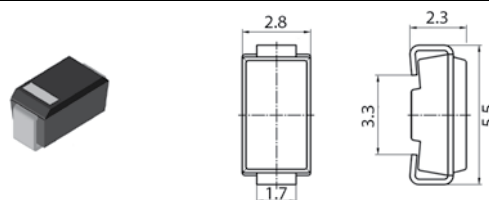

Symbol	Parametry	Rodzaj opakowania
BZG05C5V1	3W; 5,1V	tape/reel
BZG05C12TR	3W; 12V	tape/reel
BZG03C24TR	3W; 24V	tape/reel
BZG03C150TR	3W; 150V	tape/reel
BZG03C240TR	3W; 240V	tape/reel
BZG03C270TR	3W; 270V	tape/reel

Pełne dane techniczne prezentowanych podzespołów  
dostępne są w naszym katalogu internetowym:  
[www.micros.com.pl](http://www.micros.com.pl)

Diody Zenera 5W

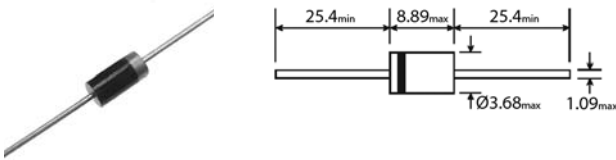

Symbol	Parametry	Rodzaj opakowania
1N5333B	5W; 3,3V	ammo
1N5335B	5W; 3,9V	ammo
1N5337B	5W; 4,7V	ammo
1N5338B	5W; 5,1V	ammo
1N5339B	5W; 5,6V	ammo
1N5341B	5W; 6,2V	ammo
1N5342B	5W; 6,8V	ammo
1N5343B	5W; 7,5V	ammo
1N5344B	5W; 8,2V	ammo
1N5346B	5W; 9,1V	ammo
1N5346B	5W; 9,1V	ammo
1N5347B	5W; 10V	ammo
1N5348B	5W; 11V	ammo
1N5349B	5W; 12V	ammo
1N5350B	5W; 13V	ammo
1N5352B	5W; 15V	ammo
1N5353B	5W; 16V	ammo
1N5355B	5W; 18V	ammo
1N5357B	5W; 20V	ammo
1N5358B	5W; 22V	ammo
1N5359B	5W; 24V	ammo
1N5361B	5W; 27V	ammo
1N5362B	5W; 28V	ammo
1N5363B	5W; 30V	ammo
1N5364B	5W; 33V	ammo
1N5365B	5W; 36V	ammo
1N5366B	5W; 39V	ammo
1N5367B	5W; 43V	ammo
1N5368B	5W; 47V	ammo
1N5369B	5W; 51V	ammo
1N5370B	5W; 56V	ammo
1N5372B	5W; 62V	ammo
1N5373B	5W; 68V	ammo
1N5375B	5W; 82V	ammo
1N5378B	5W; 100V	ammo
1N5380B	5W; 120V	ammo
1N5383B	5W; 150V	ammo
1N5384B	5W; 160V	ammo
1N5386B	5W; 180V	ammo
1N5388B	5W; 200V	ammo
BZV48C	5W; 18V	ammo

Diody Zenera SMD MICROMELF

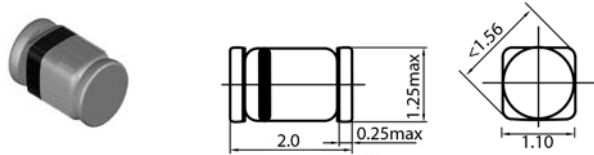

Symbol	Parametry	Rodzaj opakowania
BZM55C2V4	0,5W; 2,4V	tape/reel
BZM55C2V7	0,5W; 2,7V	tape/reel
BZM55C3V0	0,5W; 3,0V	tape/reel
BZM55C3V3	0,5W; 3,3V	tape/reel
BZM55C3V6	0,5W; 3,6V	tape/reel
BZM55C3V9	0,5W; 3,9V	tape/reel
BZM55C4V3	0,5W; 4,3V	tape/reel
BZM55C4V7	0,5W; 4,7V	tape/reel
BZM55C5V1	0,5W; 5,1V	tape/reel
BZM55C5V6	0,5W; 5,6V	tape/reel
BZM55C6V2	0,5W; 6,2V	tape/reel
BZM55C6V8	0,5W; 6,8V	tape/reel
BZM55C7V5	0,5W; 7,5V	tape/reel
BZM55C8V2	0,5W; 8,2V	tape/reel
BZM55C9V1	0,5W; 9,1V	tape/reel
BZM55C10	0,5W; 10V	tape/reel
BZM55C11	0,5W; 11V	tape/reel
BZM55C12	0,5W; 12V	tape/reel
BZM55C13	0,5W; 13V	tape/reel
BZM55C15	0,5W; 15V	tape/reel
BZM55C16	0,5W; 16V	tape/reel
BZM55C18	0,5W; 18V	tape/reel
BZM55C20	0,5W; 20V	tape/reel
BZM55C22	0,5W; 22V	tape/reel
BZM55C24	0,5W; 24V	tape/reel
BZM55C27	0,5W; 27V	tape/reel
BZM55C30	0,5W; 30V	tape/reel
BZM55C33	0,5W; 33V	tape/reel
BZM55C36	0,5W; 36V	tape/reel
BZM55C39	0,5W; 39V	tape/reel
BZM55C43	0,5W; 43V	tape/reel
BZM55C47	0,5W; 47V	tape/reel
BZM55C51	0,5W; 51V	tape/reel
BZM55C56	0,5W; 56V	tape/reel
BZM55C62	0,5W; 62V	tape/reel
BZM55C68	0,5W; 68V	tape/reel
BZM55C75	0,5W; 75V	tape/reel

Diody Zenera SMD DO214AB-SMC 5W

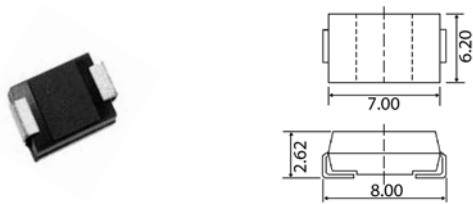

Symbol	Parametry	Rodzaj opakowania
SMC5348	5W; 11V	tape/reel
SMC5349	5W; 12V	tape/reel
SMC5350	5W; 13V	tape/reel
SMC5351	5W; 14V	tape/reel
SMC5352	5W; 15V	tape/reel
SMC5353	5W; 16V	tape/reel
SMC5354	5W; 17V	tape/reel
SMC5355	5W; 18V	tape/reel
SMC5356	5W; 19V	tape/reel
SMC5357	5W; 20V	tape/reel
SMC5358	5W; 22V	tape/reel
SMC5359	5W; 24V	tape/reel
SMC5360	5W; 25V	tape/reel
SMC5361	5W; 27V	tape/reel
SMC5362	5W; 28V	tape/reel
SMC5363	5W; 30V	tape/reel
SMC5364	5W; 33V	tape/reel
SMC5365	5W; 36V	tape/reel
SMC5366	5W; 39V	tape/reel

Pełne dane techniczne prezentowanych podzespołów dostępne są w naszym katalogu internetowym:  
[www.micros.com.pl](http://www.micros.com.pl)

# Mostki prostownicze

## Mostki prostownicze SMD

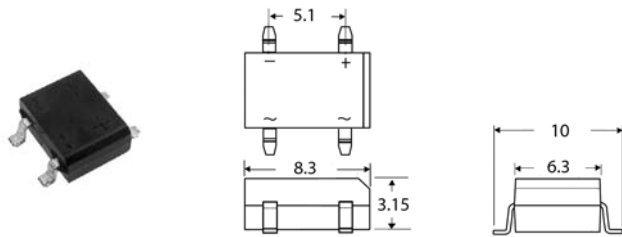

Symbol	Parametry	Rodzaj opakowania
MB2S	0.5A; 200V	tape/reel
MB4S	0.5A; 400V	tape/reel
MB6S	0.5A; 600V	tape/reel
MB6S	0.5A; 800V	tape/reel
MB10S	0.5A; 1000V	tape/reel
S12S	0.8A; 250V	tube
S250	0.8A; 600V	tube
S380	0.8A; 800V	tube
S500	0.8A; 1000V	tube
DF01S	1A; 100V	tube
DF02S	1A; 200V	tube
DF04S	1A; 400V	tube
DF06S	1A; 600V	tube
DF08S	1A; 800V	tube
DF10S	1A; 1000V	tube
DF10S	1A; 1000V	tape/reel
DB151S	1.5A; 50V	tube
DB152S	1.5A; 100V	tube
DB153S	1.5A; 200V	tube
DB154S	1.5A; 400V	tube
DB155S	1.5A; 600V	tube
DB156S	1.5A; 800V	tube
DB157S	1.5A; 1000V	tube
DB157S	1.5A; 1000V	tape/reel

## Mostki prostownicze okrągłe RB15..

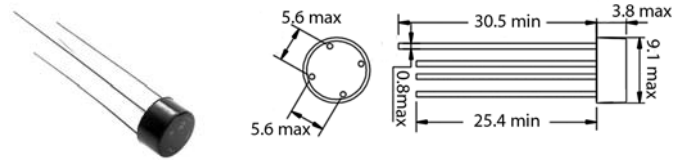

Symbol	Parametry	Rodzaj opakowania
RB151	1,5A; 50V	box
RB152	1,5A; 100V	box
RB153	1,5A; 200V	box
RB154	1,5A; 400V	box
RB155	1,5A; 600V	box
RB156	1,5A; 800V	box
RB157	1,5A; 1000V	box

## Mostki prostownicze okrągłe 2W..

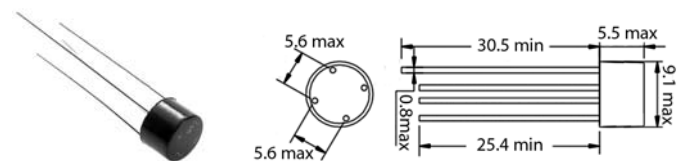

Symbol	Parametry	Rodzaj opakowania
2W005	2A; 50V	box
2W01	2A; 100V	box
2W02	2A; 200V	box
2W04	2A; 400V	box
2W06	2A; 600V	box
2W08	2A; 800V	box
2W10	2A; 1000V	box

## Mostki prostownicze PDIP

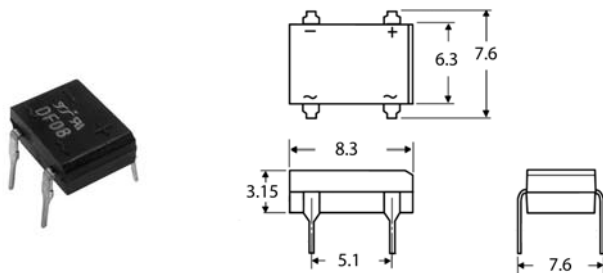

Symbol	Parametry	Rodzaj opakowania
B250C800DM	0,8A; 250V	tube
DF02	1A; 200V	tube
DF04	1A; 400V	tube
DF06	1A; 600V	tube
DF08	1A; 800V	tube
DF10	1A; 1000V	tube
DB151	1,5A; 50V	tube
DB152	1,5A; 100V	tube
DB153	1,5A; 200V	tube
DB154	1,5A; 400V	tube
DB155	1,5A; 600V	tube
DB156	1,5A; 800V	tube
DB157	1,5A; 1000V	tube
DB207	2A; 1000V	tube

## Mostki prostownicze płaskie KBP

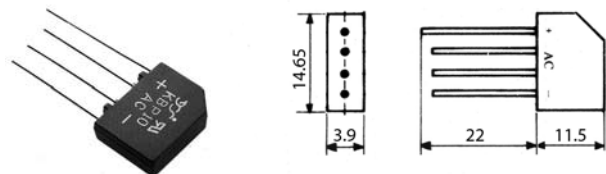

Symbol	Parametry	Rodzaj opakowania
KBP005M	1.5A; 50V	box
KBP01M	1.5A; 100V	box
KBP02M	1.5A; 200V	box
KBP04M	1.5A; 400V	box
KBP06M	1.5A; 600V	box
KBP08M	1.5A; 800V	box
KBP10M	1.5A; 1000V	box
KBP005	2A; 50V	box
KBP01	2A; 100V	box
KBP02	2A; 200V	box
KBP04	2A; 400V	box
KBP06	2A; 600V	box
KBP08	2A; 800V	box
KBP10	2A; 1000V	box

## Mostki prostownicze płaskie KBL

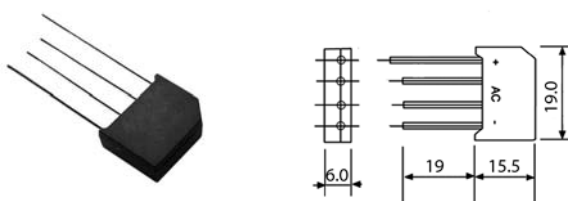

Symbol	Parametry	Rodzaj opakowania
KBL005	4A; 50V	box
KBL01	4A; 100V	box
KBL02	4A; 200V	box
KBL04	4A; 400V	box
KBL06	4A; 600V	box
KBL08	4A; 800V	box
KBL10	4A; 1000V	box

## Mostki prostownicze płaskie GBU4

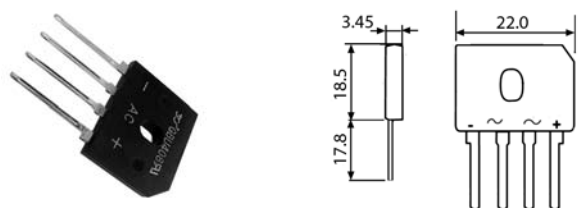

Symbol	Parametry	Rodzaj opakowania
GBU4A	4A; 50V	box
GBU4B	4A; 100V	box
GBU4D	4A; 200V	box
GBU4G	4A; 400V	box
GBU4J	4A; 600V	box
GBU4K	4A; 800V	box
GBU4M	4A; 1000V	box

Mostki prostownicze płaskie KBU

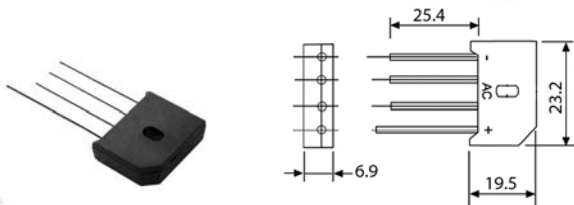

Symbol	Parametry	Rodzaj opakowania
KBU6A	6A; 50V	box
KBU6B	6A; 100V	box
KBU6D	6A; 200V	box
KBU6G	6A; 400V	box
KBU6J	6A; 600V	box
KBU6K	6A; 800V	box
KBU6M	6A; 1000V	box
KBU8A	8A; 50V	box
KBU8B	8A; 100V	box
KBU8D	8A; 200V	box
KBU8G	8A; 400V	box
KBU8J	8A; 600V	box
KBU8K	8A; 800V	box
KBU8M	8A; 1000V	box

Mostki prostownicze płaskie GBU10

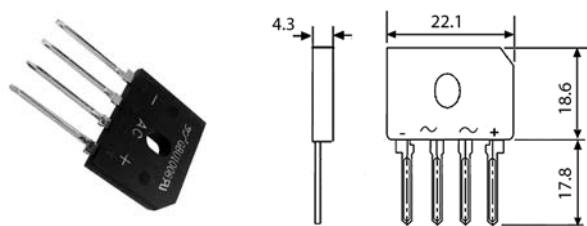

Symbol	Parametry	Rodzaj opakowania
GBU10A	10A; 50V	box
GBU10B	10A; 100V	box
GBU10D	10A; 200V	box
GBU10G	10A; 400V	box
GBU10J	10A; 600V	box
GBU10K	10A; 800V	box
GBU10M	10A; 1000V	box

Mostki prostownicze płaskie GBJ

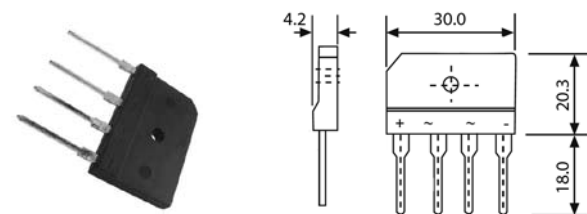

Symbol	Parametry	Rodzaj opakowania
GBJ15005	15A; 50V	box
GBJ1501	15A; 100V	box
GBJ1502	15A; 200V	box
GBJ1504	15A; 400V	box
GBJ1506	15A; 600V	box
GBJ1508	15A; 800V	box
GBJ1510	15A; 1000V	box
GBJ25005	25A; 50V	box
GBJ2501	25A; 100V	box
GBJ2502	25A; 200V	box
GBJ2504	25A; 400V	box
GBJ2506	25A; 600V	box
GBJ2508	25A; 800V	box
GBJ2510	25A; 1000V	box

Pełne dane techniczne prezentowanych podzespołów dostępne są w naszym katalogu internetowym:  
[www.micros.com.pl](http://www.micros.com.pl)

Mostki prostownicze pinowe KBPC

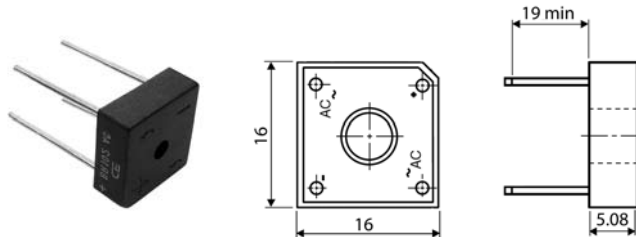

Symbol	Parametry	Rodzaj opakowania
KBPC104	3A;400V	box
KBPC106	3A;600V	box
KBPC108	3A;800V	box
KBPC110	3A;1000V	box
KBPC604	6A;400V	box
KBPC606	6A;600V	box
KBPC608	6A;800V	box
KBPC610	6A;1000V	box

Mostki prostownicze pinowe BR-10

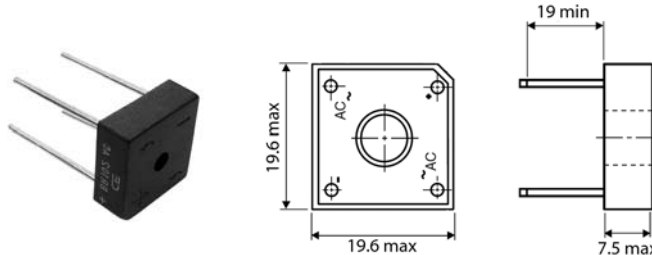

Symbol	Parametry	Rodzaj opakowania
BR1010	10A;1000V	box
BR102	10A;200V	box
BR104	10A;400V	box
BR106	10A;600V	box
BR108	10A;800V	box

Mostki prostownicze pinowe GBPC...W

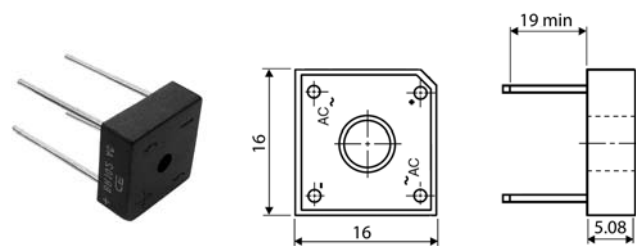

Symbol	Parametry	Rodzaj opakowania
GBPC2504W	25A;400V	box
GBPC2506W	25A;600V	box
GBPC2508W	25A;800V	box
GBPC2510W	25A;1000V	box
GBPC3504W	35A;400V	box
GBPC3506W	35A;600V	box
GBPC3508W	35A;800V	box
GBPC3510W	35A;1000V	box

Mostki prostownicze płaskie KBU10

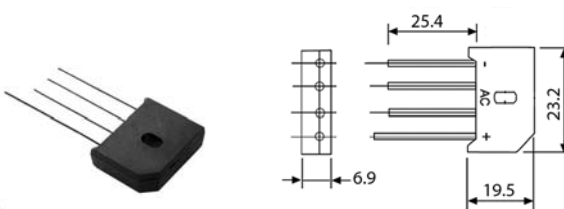

Symbol	Parametry	Rodzaj opakowania
KBU1000	10A; 50V	box
KBU1001	10A; 100V	box
KBU1002	10A; 200V	box
KBU1004	10A; 400V	box
KBU1006	10A; 600V	box
KBU1008	10A; 800V	box
KBU1010	10A; 1000V	box

## Mostki prostownicze pinowe KBPC...W

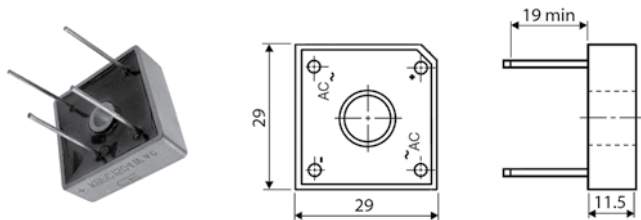

Symbol	Parametry	Rodzaj opakowania
KBPC1501W	15A;100V	box
KBPC1504W	15A;400V	box
KBPC1506W	15A;600V	box
KBPC1508W	15A;800V	box
KBPC1510W	15A;1000V	box
KBPC2501W	25A;100V	box
KBPC2502W	25A;200V	box
KBPC2504W	25A;400V	box
KBPC2506W	25A;600V	box
KBPC2508W	25A;800V	box
KBPC2510W	25A;1000V	box
KBPC3501W	35A;100V	box
KBPC3504W	35A;400V	box
KBPC3506W	35A;600V	box
KBPC3508W	35A;800V	box
KBPC3510W	35A;1000V	box
KBPC5001W	50A;100V	box
KBPC5004W	50A;400V	box
KBPC5006W	50A;600V	box
KBPC5008W	50A;800V	box
KBPC5010W	50A;1000V	box

## Mostki prostownicze konektorowe KBPC

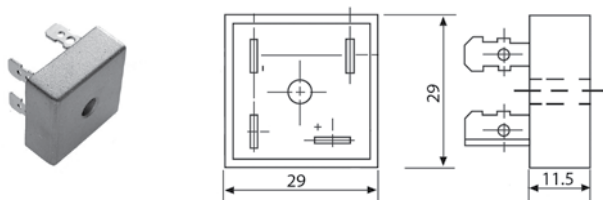

Symbol	Parametry	Rodzaj opakowania	Symbol	Parametry	Rodzaj opakowania
KBPC10005	10A; 50V	box	KBPC2508	25A; 800V	box
KBPC1001	10A; 100V	box	KBPC2510	25A; 1000V	box
KBPC1002	10A; 200V	box	KBPC35005	35A; 50V	box
KBPC1004	10A; 400V	box	KBPC3501	35A; 100V	box
KBPC1006	10A; 600V	box	KBPC3502	35A; 200V	box
KBPC1006	10A; 800V	box	KBPC3504	35A; 400V	box
KBPC1010	10A; 1000V	box	KBPC3506	35A; 600V	box
KBPC15005	15A; 50V	box	KBPC3508	35A; 800V	box
KBPC1501	15A; 100V	box	KBPC3510	35A; 1000V	box
KBPC1502	15A; 200V	box	KBPC5000	50A; 50V	box
KBPC1504	15A; 400V	box	KBPC5001	50A; 100V	box
KBPC1506	15A; 600V	box	KBPC5002	50A; 200V	box
KBPC1508	15A; 800V	box	KBPC5004	50A; 400V	box
KBPC1510	15A; 1000V	box	KBPC5006	50A; 600V	box
KBPC25005	25A; 50V	box	KBPC5008	50A; 800V	box
KBPC2501	25A; 100V	box	KBPC5010	50A; 1000V	box
KBPC2502	25A; 200V	box	KBPC5012	50A; 1200V	box
KBPC2504	25A; 400V	box	KBPC5014	50A; 1400V	box
KBPC2506	25A; 600V	box	KBPC5016	50A; 1600V	box

## Mostki prostownicze konektorowe GBPC

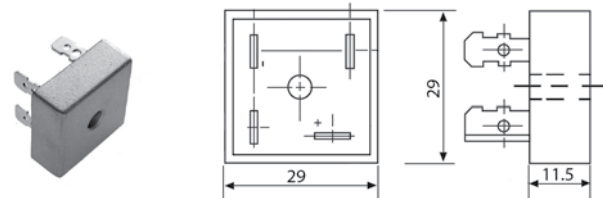

Symbol	Parametry	Rodzaj opakowania
GBPC25005	25A; 50V	box
GBPC2501	25A; 100V	box
GBPC2502	25A; 200V	box
GBPC2504	25A; 400V	box
GBPC2506	25A; 600V	box
GBPC2508	25A; 800V	box
GBPC2510	25A; 1000V	box
GBPC35005	35A; 50V	box
GBPC3501	35A; 100V	box
GBPC3502	35A; 200V	box
GBPC3504	35A; 400V	box
GBPC3506	35A; 600V	box
GBPC3508	35A; 800V	box
GBPC3510	35A; 1000V	box

## Mostki prostownicze SKBZ

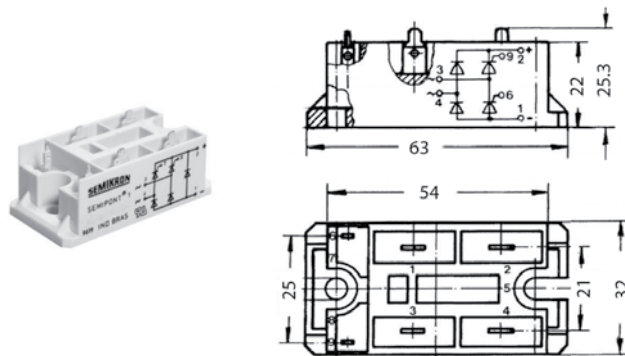

Symbol	Parametry	Rodzaj opakowania
SKBZ 28/04	28A; 400V	box
SKBZ 28/06	28A; 600V	box
SKBZ 28/08	28A; 800V	box
SKBZ 28/12	28A; 1200V	box
SKBZ 28/14	28A; 1400V	box

## Mostki prostownicze jednofazowe VBO

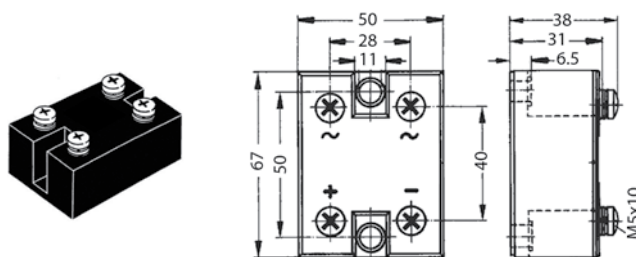

Symbol	Parametry	Rodzaj opakowania
105-08NO7	107A; 800V; 1-fazowy	box
105-12NO7	107A; 1200V; 1-fazowy	box
105-16NO7	107A; 1600V; 1-fazowy	box

## Mostki prostownicze trójfazowe

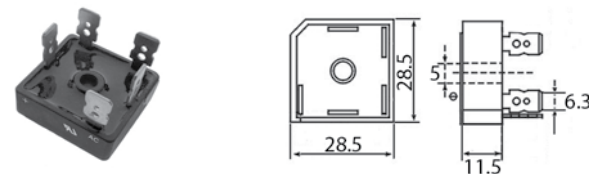

Symbol	Parametry	Rodzaj opakowania
SKBPC2504	25A; 400V	box
SKBPC2506	25A; 600V	box
SKBPC2508	25A; 800V	box
SKBPC2510	25A; 1000V	box
SKBPC2512	25A; 1200V	box
SKBPC2514	25A; 1400V	box
SKBPC2516	25A; 1600V	box
SKBPC3504	35A; 400V	box
SKBPC3506	35A; 600V	box
SKBPC3508	35A; 800V	box
SKBPC3510	35A; 1000V	box
SKBPC3512	35A; 1200V	box
SKBPC3514	35A; 1400V	box
SKBPC3516	35A; 1600V	box

## Mostki prostownicze SKD

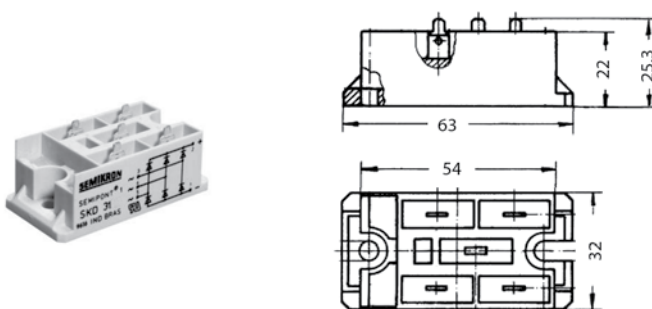

Symbol	Parametry	Rodzaj opakowania
SKD31/16	31A; 1600V	box

Jesteśmy oficjalnym dystrybutorem:



**HONGFA**  
- przekaźniki



**KINGSUN**  
- oświetlenie uliczne



**OSRAM**  
- oświetlenie LED



**HARTING**  
- złącza

**SANYODENKI**

**SANYO DENKI**  
- wentylatory DC



**VERBATIM**  
- oświetlenie LED



**HEADCON**  
- kondensatory



**KONTAKT CHEMIE**  
- chemia dla elektroniki



**TELECONTROLLI**  
- moduły radiowe ISM



**DEGSON**  
- listwy zaciskowe



**SMART DESIGN**  
- moduły Bluetooth i GPS



**V&A**  
- przyrządy pomiarowe

**MORNSUN®**

**MORNSUN**  
- przetwornice DC/DC i AC/DC



**SAB SWITCHES**  
- Przełączniki



**KINETIC**  
- akumulatory NiMh i NiCd  
- baterie



**MACROBLOCK**  
- scalone sterowniki LED



**WINCOM**  
- wyświetlacze LCD



**KINGFONT**  
- złącza do kart chipowych



**WENRUN**  
- optoelektronika



**FENGDA**  
- wentylatory



**MEDER**  
- przekaźniki  
- czujniki pola magnetycznego



**CONNFLY**  
- złącza



**JIETONG**  
- przełączniki



**YETDA**  
- optoelektronika



**KEPO**  
- elementy akustyczne



**MERA-PROJEKT**  
- moduły i urządzenia interfejsowe



**SUNTAN**  
- kondensatory  
- potencjometry



**WEIPU**  
- złącza przemysłowe



**THUNDER**  
- rezystory



**KAMCAP**  
- kondensatory



**KONEK**  
- kondensatory

odwiedź nas na naszych stronach:

**www.micros.com.pl**

katalog on-line

wyszukiwarka

zamawianie katalogów

przedstawicielstwa

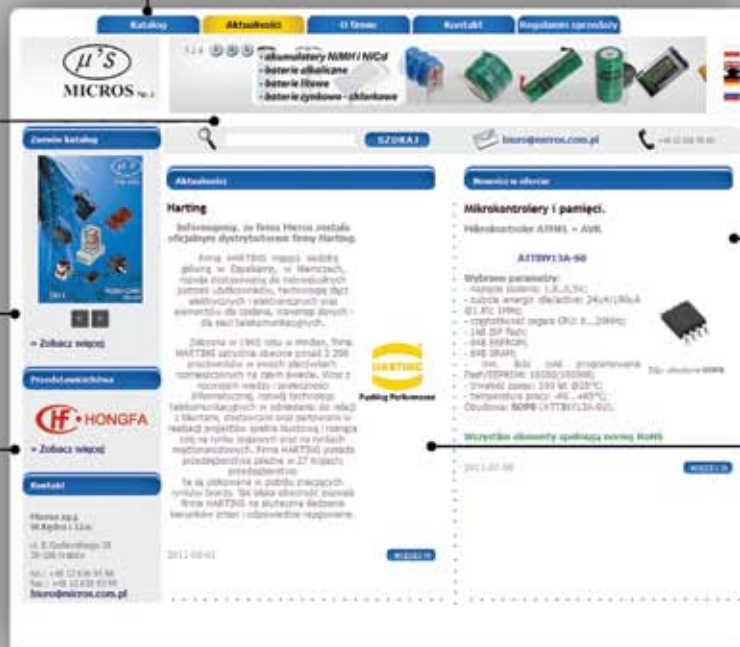

wybór języka

polecane produkty

informacje o produktach

**www.katalog.micros.com.pl**

pobieranie katalogów PDF

wyszukiwarka

drzewo katalogu



wybór języka

nazwa handlowa

opis elementu

zdjęcie elementu

stany magazynowe

rysunek techniczny

karta katalogowa

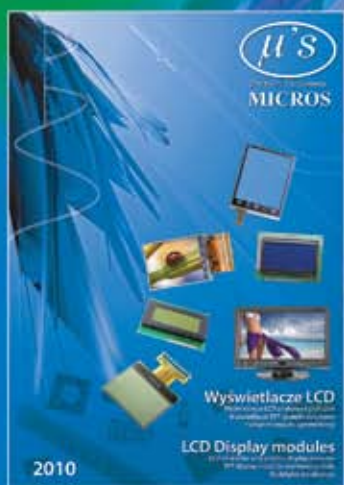
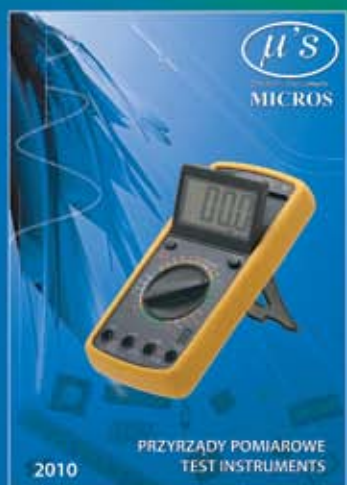
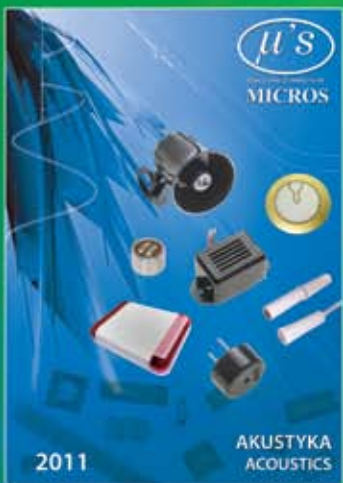
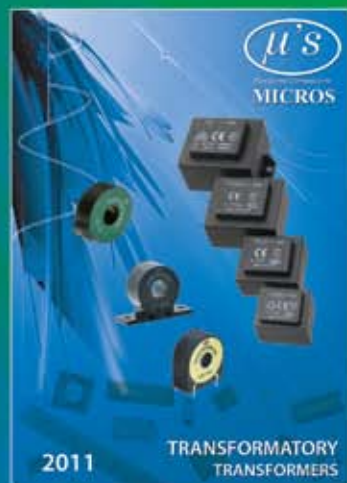

**MICROS sp.j.**  
 30-198 Kraków, ul. E.Godlewskiego 38  
 tel.: +48 12 636 95 66 fax.: +48 12 636 93 99  
 e-mail: [biuro@micros.com.pl](mailto:biuro@micros.com.pl)  
<http://www.micros.com.pl>