

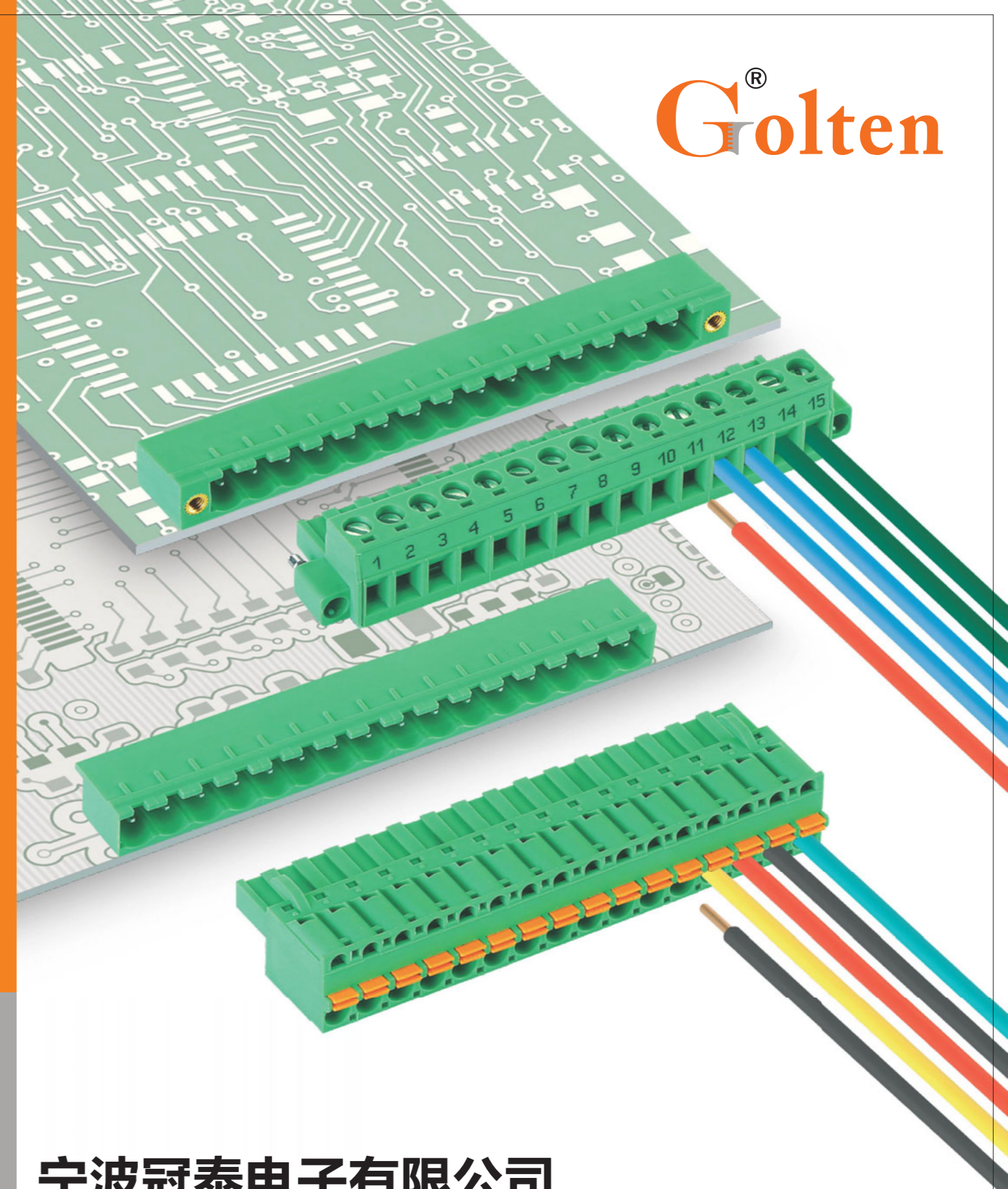

Golten®



Golten®

宁波冠泰电子有限公司  
NINGBO GOLTEN ELECTRONICS CO., LTD.

地址: 浙江省慈溪市宗汉街道马家路汉字地103号 邮编: 315301  
电话: 0574-63205538 传真: 0574-63204122  
邮箱: golten@cngolten.com  
网址: www.cngolten.com

Add: No.103, Hanzi Di, Majia Road, Zonghan Street, Cixi City, Zhejiang Province, China.  
Zip code: 315301  
Tel: +86-574-63205538 Fax: +86-574-63204122  
E-mail: golten@cngolten.com  
Web: www.cngolten.com

ISO9001 ISO14001     RoHS REACH

宁波冠泰电子有限公司  
NINGBO GOLTEN ELECTRONICS CO., LTD.

ISO9001 ISO14001     RoHS REACH



## Brief Introduction

### 企业简介

宁波冠泰电子有限公司专业制造、销售各类接线端子，产品质量优异，型号种类丰富，目前主营产品有PCB插拔式接线端子，螺钉式接线端子，弹簧式接线端子，栅栏式接线端子，贯通式接线端子。公司取得了ISO9001和ISO14001管理体系认证，产品通过了UL, CUL, VDE, CE, CQC, RoHS, REACH认证。

经过多年的不断经营和提升，公司现拥有一批经验丰富的高素质专业人才，配备国内外先进的模具制造设备和自动化生产设备，集研发、生产、销售于一体，实现产能最大化，成本最优化。产品已畅销中国、美国、英国、德国、韩国、俄罗斯、南非等20多个国家和地区，为全球的工业自动化、仪器仪表、电力电气、电梯、照明、通讯、安防等行业领域提供了优良的产品和服务。为了更好地满足广大客户的需求，我们承接OEM/ODM服务。

秉着“质量至上”的制造原则，公司严格管控原材料采购和成品生产出货过程。  
期待您的询问与合作！

Ningbo Golten Electronics Co., LTD. is a professional manufacturer and exporter that is concerned with R&D, production and sales of terminal block. We have great varieties of PCB pluggable terminal blocks, PCB screw terminal blocks, PCB spring terminal blocks, barrier terminal blocks and feed through terminal blocks. All of our products comply with international quality standards and are greatly appreciated in a variety of different market throughout the world.

Through many years of great efforts, Golten owns a team of highly-qualified and experienced staffs from mould developing, R&D department, production and QC department. Our well-equipped facilities and excellent quality control throughout all stages of production enable us to guarantee total customer's satisfaction. We have been granted ISO9001 and ISO14001 management system certifications, the products have got CUL, UL, VDE, CE, CQC, ROHS, REACH approvals.

As a result of our high-qualified products with competitive price and outstanding customer service, we have gained a global sales network reaching to more than 20 countries in many applications, such as industrial automation, lighting, security, instrument, communication, machinery, power and electric. We could offer OEM/ODM to serve customer better.

Looking forward to your enquiry and cooperation!

## Production Plant

### 厂房车间



精深的专业知识，在工业设计、模具制造、塑料件加工、金属加工、表面处理等方面得以完美的体现。先进的技术和精良工艺，在确保品质的同时极大地提高了生产效率。

The professional technology and advanced automatic assembly machines not only keep the good-qualified products, but also enhance the production efficiency and optimize the cost.





# Quality Assurance

## 品质保证



冠泰电子在实际生产过程中严格贯彻ISO管理体系，品质部门配备了多台精密检测仪器，制订严格的品质标准。以精确严谨的品管态度，做到从原材料到成品的全方面品质控制，树立精工标准，建立百年企业。

With the principle of "Quality First", we strictly follow the quality control flow. Our laboratory is equipped with many advanced testing machines to keep the good qualified products.



影像测量仪  
Image Tester



电脑全自动插拔力试验机  
Inserting-Pulling Tester



旋转拉力测试仪  
Secureness Tester



数显耐压测试仪  
Voltage Withstand Tester



多功能温升测试  
Temperature Rise Tester



灼热丝测试仪  
Glow-wire Tester

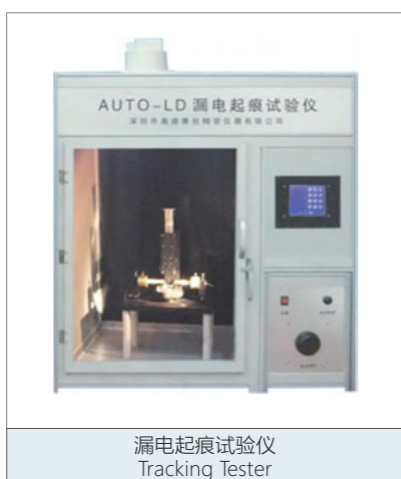

漏电起痕测试仪  
Tracking Tester



二氧化硫腐蚀试验箱  
SO<sub>2</sub> Protection Against Corrosion Tester

# Certificates

## 认证证书



### 品质流程图 Quality Flow Chart

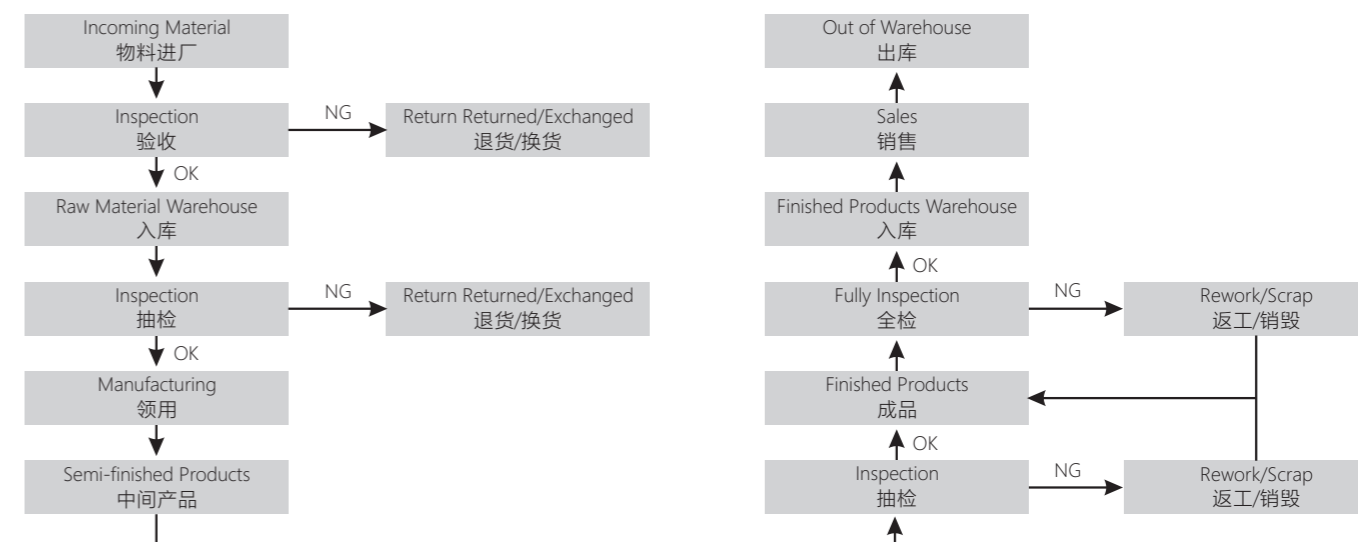



# Contents

## 产品目录

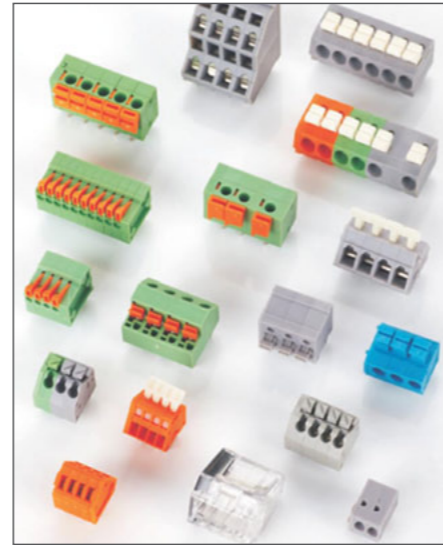
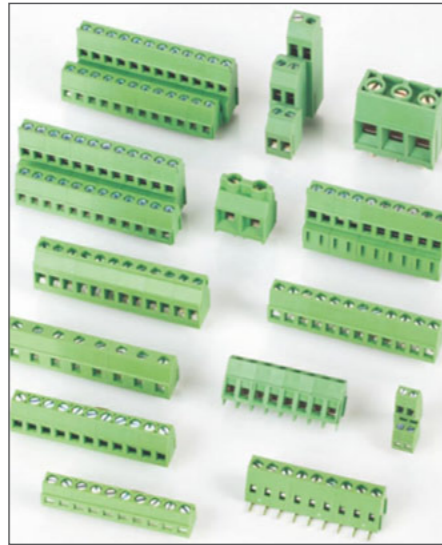
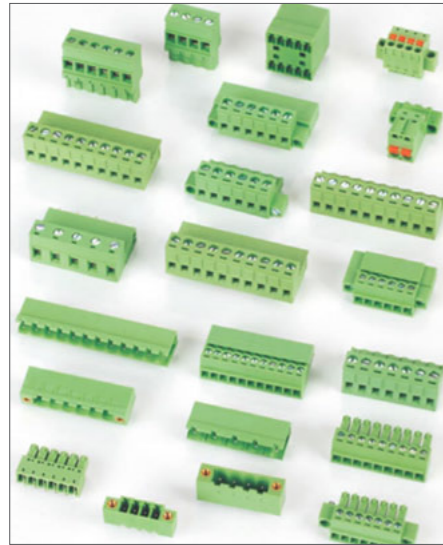

**插拔式接线端子** P07-27  
**Pluggable Terminal Blocks**

插拔式接线端子提供2.5mm, 3.5mm, 3.81mm, 5.0mm, 5.08mm, 7.5mm, 7.62mm, 10.0mm, 10.16mm等不同间距的插头。为了应用不同场合的使用需求, 提供水平插头、垂直插头、与同方向进线插头等选择。产品设计符合IEC60998、UL1059等国际标准并通过UL等认证。

Pluggable terminal blocks have different pitches from 2.5mm to 10.16mm. Depending on the application, different plugs at various angles (Horizontal Entry, Vertical entry, and Front Entry types of plugs) are available for making connections. They also have large contact surface, high shock-resistance, and low tendency to loosen. The product is designed comply with international quality standards, such as IEC60998 and UL1059.

**PCB螺钉式接线端子** P28-41  
**PCB Screw Terminal Blocks**

PCB螺钉式接线端子的间距3.5mm、3.81mm、5.0mm、5.08mm、6.35mm、7.5mm、7.62mm、9.5mm、10.0mm、10.16mm, 并含有90°, 135°, 180°, 等三种进线方向, 配合单层、双层和三层的設計, 使应用的选择性多样化。产品设计符合IEC60998, UL1059等国际标准并通过UL等认证。

PCB screw terminal blocks can be soldered directly onto a PCB, which have different pitches from 3.5mm to 10.16mm. Different wiring angles at 90°, 135°, 180° could accommodate single-, dual-, or triple-layered designs and increase application diversity. Most of PCB screw terminal block series provide 2p and 3p bases and can be combined into any pole number. The product is designed comply with international quality standards, such as IEC60998 and UL1059.

**PCB弹簧式接线端子** P42-47  
**PCB Spring Terminal Blocks**

PCB弹簧式接线端子有2.5mm、2.54mm、3.5mm、5.0mm、7.5mm、7.62mm、10.0mm等间距, 圆棒端子及单芯线能直接插入, 不需要手把辅助, 但较小的电线可用手把打开夹子将电线夹紧。大部分免螺丝式端子台都是以一片一片组合而成。产品设计符合IEC60998、UL1059等国际标准, 大部分产品通过UL等认证。

PCB spring terminal blocks with different pitches from 2.5mm to 10.00mm, using highly reliable elastic material that is resistant to shock, easy to match, and simple to assemble. The ferrule and single-strand wires can be inserted directly without handles, and smaller wires can be secured by using the handle to open the clips. Due to the direction and alignment of the wires, these blocks are suitable for use with small space, and can be combined in any numbers. The product is designed comply with international quality standards, such as IEC60998 and UL1059.

### 订购方式

#### How to order

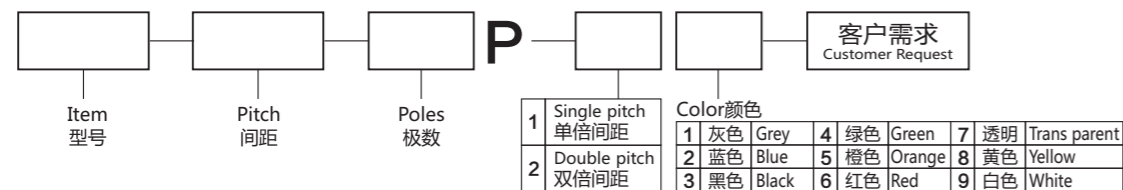

**贯通式接线端子** P48-50  
**Feed Through Terminal Blocks**

贯通式接线端子不带保险丝, 它可将二导体方便、可靠连接起来。可以连接0.5mm<sup>2</sup>至35mm<sup>2</sup>的所有类型的导线。产品设计符合IEC60998、UL1059等国际标准并通过UL等认证。

Feed through terminal blocks is available with different wire sizes from 0.5mm<sup>2</sup> to 35mm<sup>2</sup>. They could connect two conductors easily and stably. The product is designed comply with international quality standards, such as IEC60998 and UL1059.

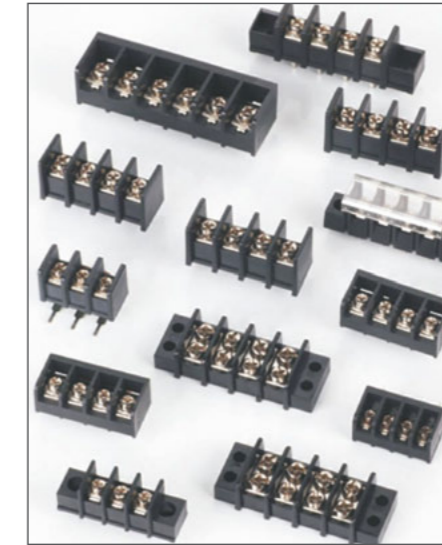

**栅栏式接线端子** P51-65  
**Barrier Terminal Blocks**

栅栏式接线端子, 接线直观明了, 可以连接截面为0.5mm<sup>2</sup>至6.0mm<sup>2</sup>的所有类型的导线。间距6.35-14mm可供选择。可提供有盖、无盖等款式。产品设计符合IEC60998, UL1059等国际标准。

Barrier terminal blocks is available with different wire sizes from 0.5mm<sup>2</sup> to 6.0mm<sup>2</sup>. The pitches could be from 6.35mm to 14.0mm. The product is designed comply with international quality standards, such as IEC60998 and UL1059.

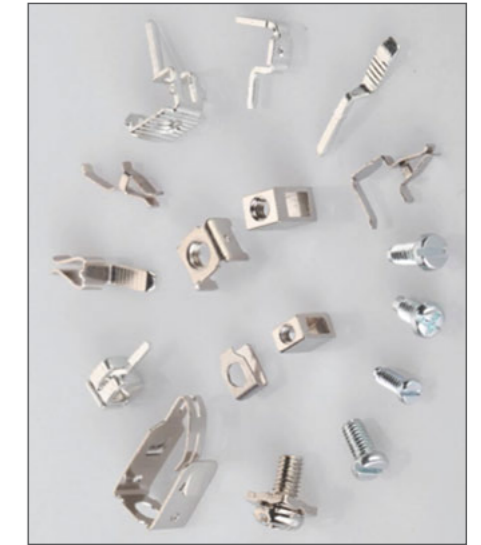

**OEM/ODM产品** P66  
**OEM/ODM Products**

专业素养的科研团队, 强大的技术研发中心、模具制造中心、生产加工中心, 能快速把握客户需求, 为广大客户提供OEM/ODM产品。

With the professional technology and advanced equipment, GOLTEN could provide OEM/ODM products for customers.

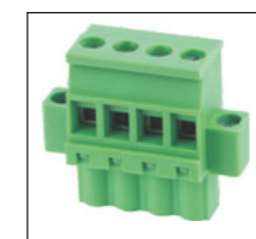

**2EGTKBM-5.08-04P-14-00AH**





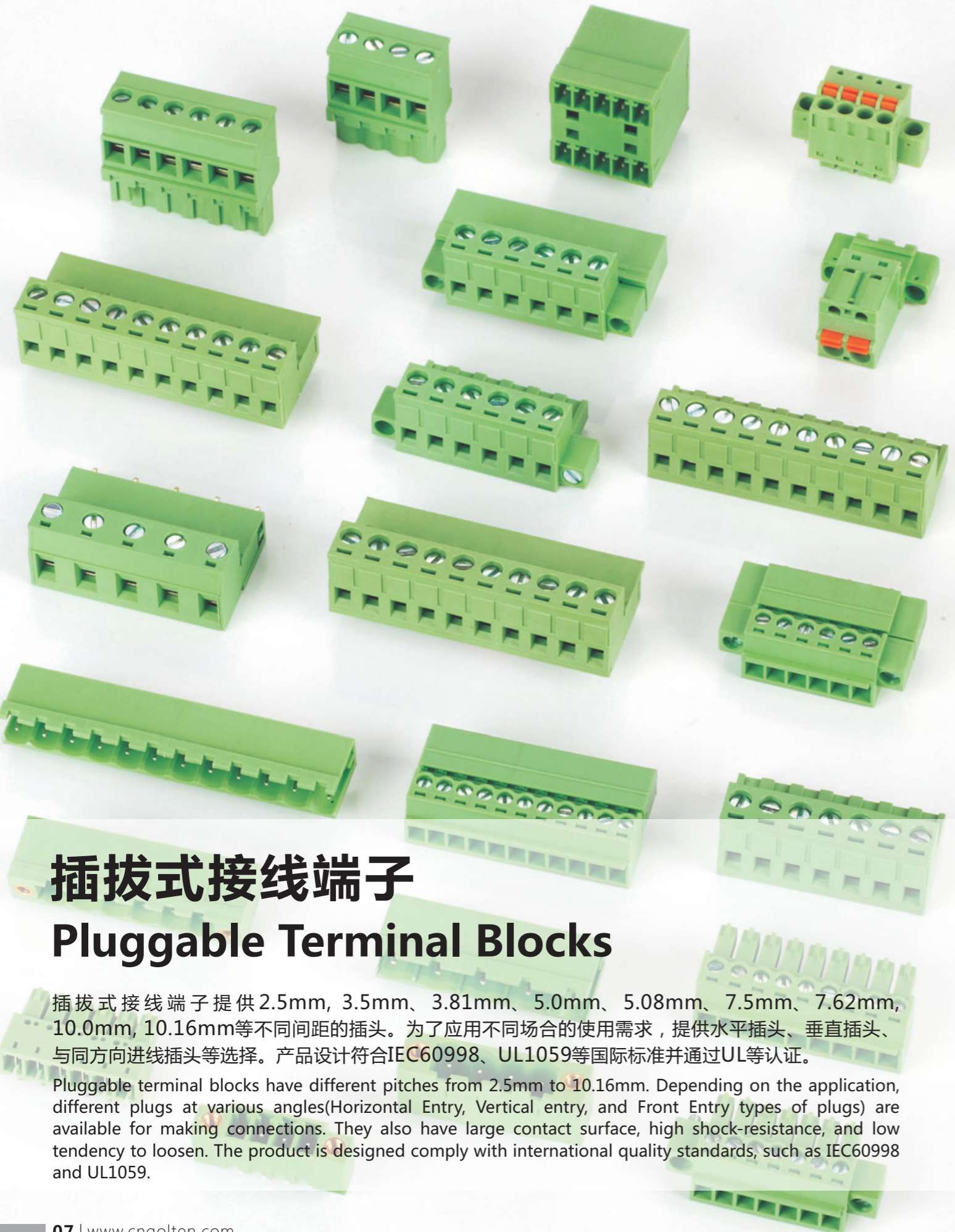







# 插拔式接线端子 Pluggable Terminal Blocks

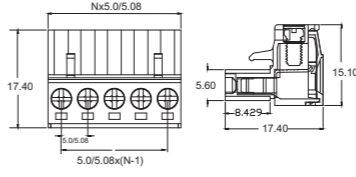
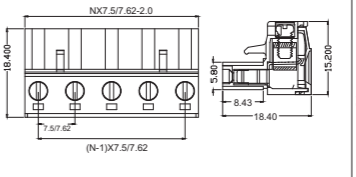
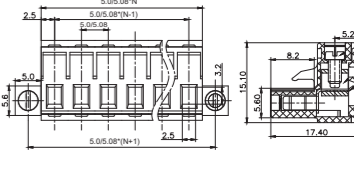

插拔式接线端子提供2.5mm、3.5mm、3.81mm、5.0mm、5.08mm、7.5mm、7.62mm、10.0mm、10.16mm等不同间距的插头。为了应用不同场合的使用需求，提供水平插头、垂直插头、与同方向进线插头等选择。产品设计符合IEC60998、UL1059等国际标准并通过UL等认证。

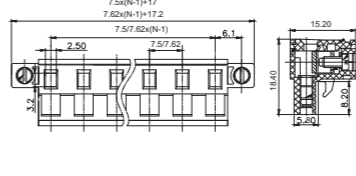
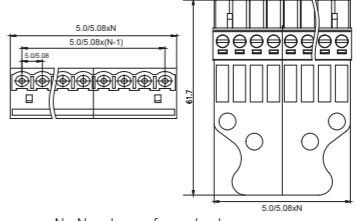
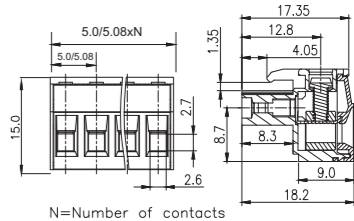

Pluggable terminal blocks have different pitches from 2.5mm to 10.16mm. Depending on the application, different plugs at various angles(Horizontal Entry, Vertical entry, and Front Entry types of plugs) are available for making connections. They also have large contact surface, high shock-resistance, and low tendency to loosen. The product is designed comply with international quality standards, such as IEC60998 and UL1059.



产品型号 MODEL	2EGTK-5.0 2EGTK-5.08	2EGTK-7.5 2EGTK-7.62	2EGTKM-5.0 2EGTKM-5.08
产品照片 Photo	 Pole:2-24P Pitch:5.0/5.08mm	 Pole:2-12P Pitch:7.5/7.62mm	 Pole:2-22P Pitch:5.0/5.08mm
产品图纸 Plan	 N=Number of contacts	 N=Number of contacts	 N=Number of contacts
材质/电镀 MATERIAL	塑件 Housing PA66,UL94V-0 螺丝 Screws M2.5,钢,镀Cr <sup>3+</sup> 钝化彩锌 M2.5,steel,Cr <sup>3+</sup> Zn plated 触点材料 Contact 磷青铜 Phosphor bronze 方盒 Cage 黄铜,镀镍 Brass,Ni plated	塑件 Housing PA66,UL94V-0 螺丝 Screws M2.5,钢,镀Cr <sup>3+</sup> 钝化彩锌 M2.5,steel,Cr <sup>3+</sup> Zn plated 触点材料 Contact 磷青铜 Phosphor bronze 方盒 Cage 黄铜,镀镍 Brass,Ni plated	塑件 Housing PA66,UL94V-0 螺丝 Screws M2.5,钢,镀Cr <sup>3+</sup> 钝化彩锌 M2.5,steel,Cr <sup>3+</sup> Zn plated 触点材料 Contact 磷青铜 Phosphor bronze 方盒 Cage 黄铜,镀镍 Brass,Ni plated
电气性能 ELECTRICAL	UL IEC	UL IEC	UL IEC
额定电压 Rated voltage	300V 320V	300V 400V	300V 320V
额定电流 Rated current	15A 20A	15A 20A	15A 20A
使用线径 Wire range	28~12AWG 2.5mm <sup>2</sup>	28~12AWG 2.5mm <sup>2</sup>	28~12AWG 2.5mm <sup>2</sup>

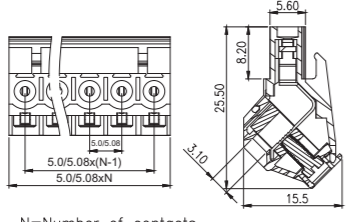
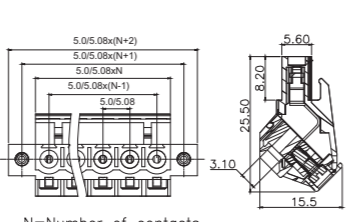
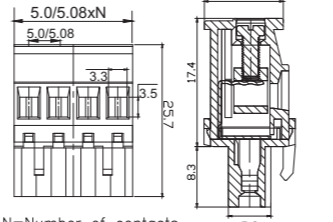

产品型号 MODEL	2EGTKM-7.5 2EGTKM-7.62	2EGTKE-5.0 2EGTKE-5.08	2EGTKF-5.0 2EGTKF-5.08
产品照片 Photo	 Pole:2-12P Pitch:7.5/7.62mm	 Pole:2-16P Pitch:5.0/5.08mm	 Pole:2-22P Pitch:5.0/5.08mm
产品图纸 Plan	 N=Number of contacts	 N=Number of contacts	 N=Number of contacts
材质/电镀 MATERIAL	塑件 Housing PA66,UL94V-0 螺丝 Screws M2.5,钢,镀Cr <sup>3+</sup> 钝化彩锌 M2.5,steel,Cr <sup>3+</sup> Zn plated 触点材料 Contact 磷青铜 Phosphor bronze 方盒 Cage 黄铜,镀镍 Brass,Ni plated	塑件 Housing PA66,UL94V-0 螺丝 Screws M2.5,钢,镀Cr <sup>3+</sup> 钝化彩锌 M2.5,steel,Cr <sup>3+</sup> Zn plated 触点材料 Contact 磷青铜 Phosphor bronze 方盒 Cage 黄铜,镀镍 Brass,Ni plated	塑件 Housing PA66,UL94V-0 螺丝 Screws M2.5,钢,镀Cr <sup>3+</sup> 钝化彩锌 M2.5,steel,Cr <sup>3+</sup> Zn plated 触点材料 Contact 磷青铜 Phosphor bronze 方盒 Cage 黄铜,镀镍 Brass,Ni plated
电气性能 ELECTRICAL	UL IEC	UL IEC	UL IEC
额定电压 Rated voltage	300V 400V	300V 320V	300V 320V
额定电流 Rated current	15A 20A	15A 20A	15A 20A
使用线径 Wire range	28~12AWG 2.5mm <sup>2</sup>	28~12AWG 2.5mm <sup>2</sup>	28~12AWG 0.2~2.5mm <sup>2</sup>

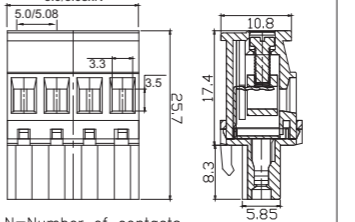
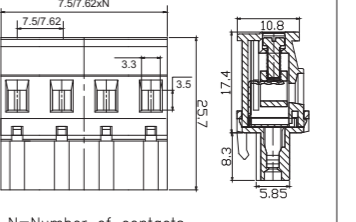
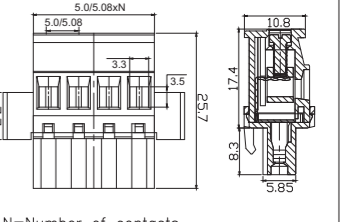

产品型号 MODEL	2EGTKL-5.0 2EGTKL-5.08	2EGTKLM-5.0 2EGTKLM-5.08	2EGTKA-5.0 2EGTKA-5.08
产品照片 Photo			
产品图纸 Plan			
材质/电镀 MATERIAL	塑件 Housing PA66,UL94V-0 螺丝 Screws M2.5,钢,镀Cr <sup>3+</sup> 钝化彩锌 M2.5,steel,Cr <sup>3+</sup> Zn plated 触点材料 Contact 磷青铜 Phosphor bronze 方盒 Cage 黄铜,镀镍 Brass,Ni plated	塑件 Housing PA66,UL94V-0 螺丝 Screws M2.5,钢,镀Cr <sup>3+</sup> 钝化彩锌 M2.5,steel,Cr <sup>3+</sup> Zn plated 触点材料 Contact 磷青铜 Phosphor bronze 方盒 Cage 黄铜,镀镍 Brass,Ni plated	塑件 Housing PA66,UL94V-0 螺丝 Screws M2.5,钢,镀Cr <sup>3+</sup> 钝化彩锌 M2.5,steel,Cr <sup>3+</sup> Zn plated 触点材料 Contact 磷青铜 Phosphor bronze 方盒 Cage 黄铜,镀镍 Brass,Ni plated
电气性能 ELECTRICAL	UL IEC 额定电压 Rated voltage 300V 320V 额定电流 Rated current 10A 20A 使用线径 Wire range 24~12AWG 2.5mm <sup>2</sup>	UL IEC 额定电压 Rated voltage 300V 320V 额定电流 Rated current 10A 20A 使用线径 Wire range 24~12AWG 2.5mm <sup>2</sup>	UL IEC 额定电压 Rated voltage 300V 320V 额定电流 Rated current 15A 10A 使用线径 Wire range 28~12AWG 2.5mm <sup>2</sup>

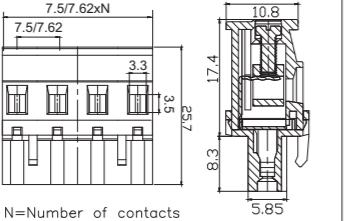
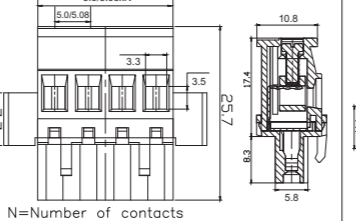
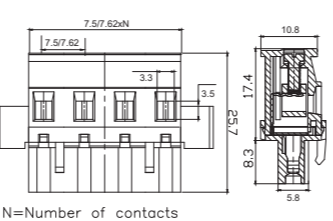
产品型号 MODEL	2EGTKB-5.0 2EGTKB-5.08	2EGTKB-7.5 2EGTKB-7.62	2EGTKBM-5.0 2EGTKBM-5.08
产品照片 Photo			
产品图纸 Plan			
材质/电镀 MATERIAL	塑件 Housing PA66,UL94V-0 螺丝 Screws M2.5,钢,镀Cr <sup>3+</sup> 钝化彩锌 M2.5,steel,Cr <sup>3+</sup> Zn plated 触点材料 Contact 磷青铜 Phosphor bronze 方盒 Cage 黄铜,镀镍 Brass,Ni plated	塑件 Housing PA66,UL94V-0 螺丝 Screws M2.5,钢,镀Cr <sup>3+</sup> 钝化彩锌 M2.5,steel,Cr <sup>3+</sup> Zn plated 触点材料 Contact 磷青铜 Phosphor bronze 方盒 Cage 黄铜,镀镍 Brass,Ni plated	塑件 Housing PA66,UL94V-0 螺丝 Screws M2.5,钢,镀Cr <sup>3+</sup> 钝化彩锌 M2.5,steel,Cr <sup>3+</sup> Zn plated 触点材料 Contact 磷青铜 Phosphor bronze 方盒 Cage 黄铜,镀镍 Brass,Ni plated
电气性能 ELECTRICAL	UL IEC 额定电压 Rated voltage 300V 320V 额定电流 Rated current 15A 10A 使用线径 Wire range 28~12AWG 2.5mm <sup>2</sup>	UL IEC 额定电压 Rated voltage 300V 400V 额定电流 Rated current 15A 10A 使用线径 Wire range 28~12AWG 2.5mm <sup>2</sup>	UL IEC 额定电压 Rated voltage 300V 320V 额定电流 Rated current 15A 10A 使用线径 Wire range 28~12AWG 2.5mm <sup>2</sup>

产品型号 MODEL	2EGTKA-7.5 2EGTKA-7.62	2EGTKAM-5.0 2EGTKAM-5.08	2EGTKAM-7.5 2EGTKAM-7.62
产品照片 Photo			
产品图纸 Plan			
材质/电镀 MATERIAL	塑件 Housing PA66,UL94V-0 螺丝 Screws M2.5,钢,镀Cr <sup>3+</sup> 钝化彩锌 M2.5,steel,Cr <sup>3+</sup> Zn plated 触点材料 Contact 磷青铜 Phosphor bronze 方盒 Cage 黄铜,镀镍 Brass,Ni plated	塑件 Housing PA66,UL94V-0 螺丝 Screws M2.5,钢,镀Cr <sup>3+</sup> 钝化彩锌 M2.5,steel,Cr <sup>3+</sup> Zn plated 触点材料 Contact 磷青铜 Phosphor bronze 方盒 Cage 黄铜,镀镍 Brass,Ni plated	塑件 Housing PA66,UL94V-0 螺丝 Screws M2.5,钢,镀Cr <sup>3+</sup> 钝化彩锌 M2.5,steel,Cr <sup>3+</sup> Zn plated 触点材料 Contact 磷青铜 Phosphor bronze 方盒 Cage 黄铜,镀镍 Brass,Ni plated
电气性能 ELECTRICAL	UL IEC 额定电压 Rated voltage 300V 400V 额定电流 Rated current 15A 10A 使用线径 Wire range 28~12AWG 2.5mm <sup>2</sup>	UL IEC 额定电压 Rated voltage 300V 320V 额定电流 Rated current 15A 10A 使用线径 Wire range 28~12AWG 2.5mm <sup>2</sup>	UL IEC 额定电压 Rated voltage 300V 400V 额定电流 Rated current 15A 10A 使用线径 Wire range 28~12AWG 2.5mm <sup>2</sup>

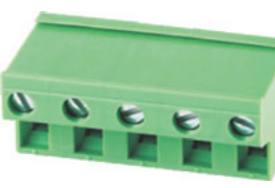
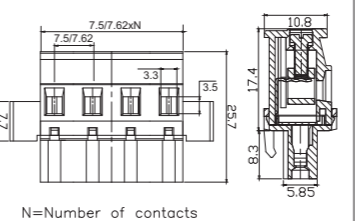
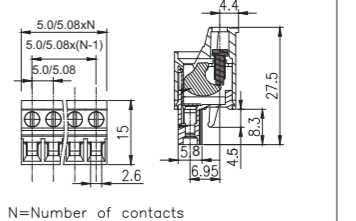
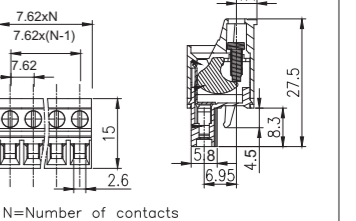
产品型号 MODEL	2EGTKBM-7.5 2EGTKBM-7.62	2EGTKC-5.0 2EGTKC-5.08	2EGTKC-7.62
产品照片 Photo			
产品图纸 Plan			
材质/电镀 MATERIAL	塑件 Housing PA66,UL94V-0 螺丝 Screws M2.5,钢,镀Cr <sup>3+</sup> 钝化彩锌 M2.5,steel,Cr <sup>3+</sup> Zn plated 触点材料 Contact 磷青铜 Phosphor bronze 方盒 Cage 黄铜,镀镍 Brass,Ni plated	塑件 Housing PA66,UL94V-0 螺丝 Screws M2.5,钢,镀Cr <sup>3+</sup> 钝化彩锌 M2.5,steel,Cr <sup>3+</sup> Zn plated 触点材料 Contact 磷青铜 Phosphor bronze 方盒 Cage 钢,镀Cr <sup>3+</sup> 钝化彩锌 Steel, Cr <sup>3+</sup> Zn plated	塑件 Housing PA66,UL94V-0 螺丝 Screws M2.5,钢,镀Cr <sup>3+</sup> 钝化彩锌 M2.5,steel,Cr <sup>3+</sup> Zn plated 触点材料 Contact 磷青铜 Phosphor bronze 方盒 Cage 钢,镀Cr <sup>3+</sup> 钝化彩锌 Steel, Cr <sup>3+</sup> Zn plated
电气性能 ELECTRICAL	UL IEC 额定电压 Rated voltage 300V 400V 额定电流 Rated current 15A 10A 使用线径 Wire range 28~12AWG 2.5mm <sup>2</sup>	UL IEC 额定电压 Rated voltage 300V 320V 额定电流 Rated current 10A 20A 使用线径 Wire range 28~12AWG 0.2~2.5mm <sup>2</sup>	UL IEC 额定电压 Rated voltage 300V 400V 额定电流 Rated current 10A 20A 使用线径 Wire range 28~12AWG 0.2~2.5mm <sup>2</sup>





产品型号 MODEL	2EGTKCM-5.0 2EGTKCM-5.08	2EGTKCM-7.62	2EGTKH-5.08
产品照片 Photo			
产品图纸 Plan			
材质/电镀 MATERIAL	塑件 Housing PA66,UL94V-0 螺丝 Screws M2.5,钢,镀Cr <sup>3+</sup> 钝化彩锌 M2.5,steel,Cr <sup>3+</sup> Zn plated 触点材料 Contact 磷青铜 Phosphor bronze 方盒 Cage 钢,镀Cr <sup>3+</sup> 钝化彩锌 Steel, Cr <sup>3+</sup> Zn plated	塑件 Housing PA66,UL94V-0 螺丝 Screws M2.5,钢,镀Cr <sup>3+</sup> 钝化彩锌 M2.5,steel,Cr <sup>3+</sup> Zn plated 触点材料 Contact 磷青铜 Phosphor bronze 方盒 Cage 钢,镀Cr <sup>3+</sup> 钝化彩锌 Steel, Cr <sup>3+</sup> Zn plated	塑件 Housing PA66,UL94V-0 螺丝 Screws M2.5,钢,镀Cr <sup>3+</sup> 钝化彩锌 M2.5,steel,Cr <sup>3+</sup> Zn plated 触点材料 Contact 磷青铜 Phosphor bronze 方盒 Cage 黄铜,镀镍 Brass,Ni plated
电气性能 ELECTRICAL	UL IEC 额定电压 Rated voltage 300V 320V 额定电流 Rated current 10A 20A 使用线径 Wire range 28~12AWG 0.2~2.5mm <sup>2</sup>	UL IEC 额定电压 Rated voltage 300V 400V 额定电流 Rated current 10A 20A 使用线径 Wire range 28~12AWG 0.2~2.5mm <sup>2</sup>	UL IEC 额定电压 Rated voltage 300V 320V 额定电流 Rated current 10A 15A 使用线径 Wire range 28~12AWG 2.5mm <sup>2</sup>



产品型号 MODEL	2EGTKR-7.62	2EGTKRM-5.08	2EGTKRM-7.62
产品照片 Photo			
产品图纸 Plan			
材质/电镀 MATERIAL	塑件 Housing PA66,UL94V-0 螺丝 Screws M2.5,钢,镀Cr <sup>3+</sup> 钝化彩锌 M2.5,steel,Cr <sup>3+</sup> Zn plated 触点材料 Contact 黄铜 Brass 方盒 Cage 黄铜,镀镍 Brass,Ni plated	塑件 Housing PA66,UL94V-0 螺丝 Screws M2.5,钢,镀Cr <sup>3+</sup> 钝化彩锌 M2.5,steel,Cr <sup>3+</sup> Zn plated 触点材料 Contact 黄铜 Brass 方盒 Cage 黄铜,镀镍 Brass,Ni plated	塑件 Housing PA66,UL94V-0 螺丝 Screws M2.5,钢,镀Cr <sup>3+</sup> 钝化彩锌 M2.5,steel,Cr <sup>3+</sup> Zn plated 触点材料 Contact 黄铜 Brass 方盒 Cage 黄铜,镀镍 Brass,Ni plated
电气性能 ELECTRICAL	UL IEC 额定电压 Rated voltage 300V 400V 额定电流 Rated current 15A 20A 使用线径 Wire range 28~12AWG 2.5mm <sup>2</sup>	UL IEC 额定电压 Rated voltage 300V 320V 额定电流 Rated current 15A 20A 使用线径 Wire range 28~12AWG 2.5mm <sup>2</sup>	UL IEC 额定电压 Rated voltage 300V 400V 额定电流 Rated current 15A 20A 使用线径 Wire range 28~12AWG 2.5mm <sup>2</sup>

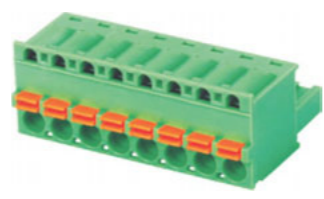

产品型号 MODEL	2EGTKHM-5.08	2EGTKP-5.0	2EGTKR-5.08
产品照片 Photo			
产品图纸 Plan			
材质/电镀 MATERIAL	塑件 Housing PA66,UL94V-0 螺丝 Screws M2.5,钢,镀Cr <sup>3+</sup> 钝化彩锌 M2.5,steel,Cr <sup>3+</sup> Zn plated 触点材料 Contact 磷青铜 Phosphor bronze 方盒 Cage 黄铜,镀镍 Brass,Ni plated	塑件 Housing PA66,UL94V-0 螺丝 Screws M2.5,钢,镀Cr <sup>3+</sup> 钝化彩锌 M2.5,steel,Cr <sup>3+</sup> Zn plated 触点材料 Contact 黄铜 Brass 方盒 Cage 黄铜,镀镍 Brass,Ni plated	塑件 Housing PA66,UL94V-0 螺丝 Screws M2.5,钢,镀Cr <sup>3+</sup> 钝化彩锌 M2.5,steel,Cr <sup>3+</sup> Zn plated 触点材料 Contact 黄铜 Brass 方盒 Cage 黄铜,镀镍 Brass,Ni plated
电气性能 ELECTRICAL	UL IEC 额定电压 Rated voltage 300V 320V 额定电流 Rated current 10A 15A 使用线径 Wire range 28~12AWG 2.5mm <sup>2</sup>	UL IEC 额定电压 Rated voltage 300V 320V 额定电流 Rated current 15A 20A 使用线径 Wire range 28~12AWG 2.5mm <sup>2</sup>	UL IEC 额定电压 Rated voltage 300V 320V 额定电流 Rated current 15A 20A 使用线径 Wire range 28~12AWG 2.5mm <sup>2</sup>

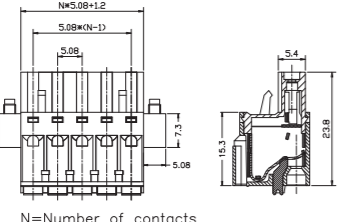
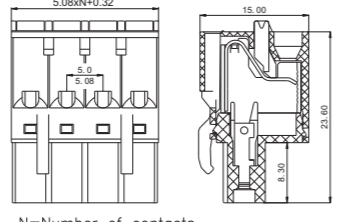
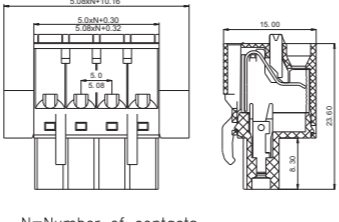

产品型号 MODEL	2EGTKRP-5.0	2EGTKRP-5.08	2EGTKD-5.0 2EGTKD-5.08
产品照片 Photo			
产品图纸 Plan			
材质/电镀 MATERIAL	塑件 Housing PA66,UL94V-0 触点材料 Contact 黄铜 Brass 方盒 Cage 黄铜,镀镍 Brass,Ni plated 螺丝 Screws M2.5,黄铜 M2.5,Brass	塑件 Housing PA66,UL94V-0 触点材料 Contact 黄铜 Brass 方盒 Cage 黄铜,镀镍 Brass,Ni plated 螺丝 Screws M2.5,黄铜 M2.5,Brass	塑件 Housing PA66,UL94V-0 触点材料 Contact 磷青铜 Phosphor bronze 方盒 Cage 不锈钢 Stainless steel
电气性能 ELECTRICAL	UL IEC 额定电压 Rated voltage 300V 320V 额定电流 Rated current 15A 20A 使用线径 Wire range 28~12AWG 2.5mm <sup>2</sup>	UL IEC 额定电压 Rated voltage 300V 320V 额定电流 Rated current 15A 20A 使用线径 Wire range 28~12AWG 2.5mm <sup>2</sup>	UL IEC 额定电压 Rated voltage 300V 320V 额定电流 Rated current 10A 20A 使用线径 Wire range 26~12AWG 0.2~2.5mm <sup>2</sup>

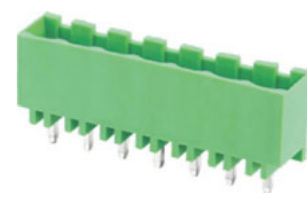
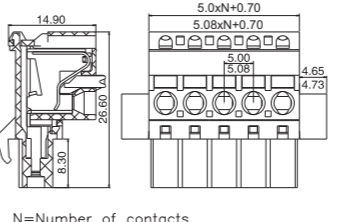
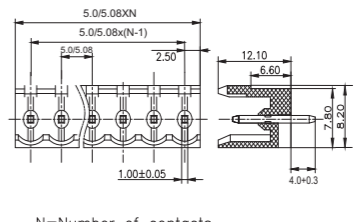
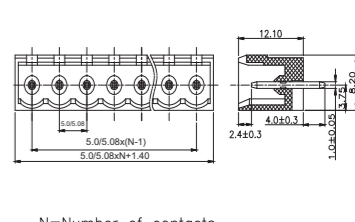

产品型号 MODEL	2EGTKDM-5.0 2EGTKDM-5.08	2EGTKDF-5.0 2EGTKDF-5.08	2EGTKDFM-5.0 2EGTKDFM-5.08
产品照片 Photo	 Pole:2-16P Pitch:5.0/5.08mm	 Pole:2-18P Pitch:5.0/5.08mm	 Pole:2-16P Pitch:5.0/5.08mm
产品图纸 Plan	 N=Number of contacts	 N=Number of contacts	 N=Number of contacts
材质/电镀 MATERIAL	塑件 Housing PA66,UL94V-0	塑件 Housing PA66,UL94V-0	塑件 Housing PA66,UL94V-0
触点材料 Contact	磷青铜 Phosphor bronze	磷青铜 Phosphor bronze	磷青铜 Phosphor bronze
簧片 Wire guard	不锈钢 Stainless steel	不锈钢 Stainless steel	不锈钢 Stainless steel
螺丝 Screws	M2.5,钢,镀Cr <sup>3+</sup> 钝化彩锌 M2.5,steel,Cr <sup>3+</sup> Zn plated	-	M2.5,钢,镀Cr <sup>3+</sup> 钝化彩锌 M2.5,steel,Cr <sup>3+</sup> Zn plated
电气性能 ELECTRICAL	UL IEC	UL IEC	UL IEC
额定电压 Rated voltage	300V 320V	300V 320V	300V 320V
额定电流 Rated current	10A 20A	10A 20A	10A 20A
使用线径 Wire range	26~12AWG 0.2~2.5mm <sup>2</sup>	26~12AWG 2.5mm <sup>2</sup>	26~12AWG 2.5mm <sup>2</sup>

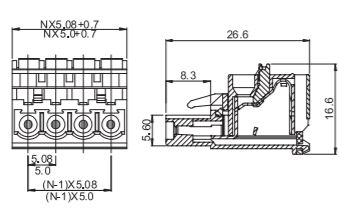
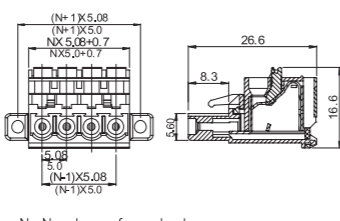
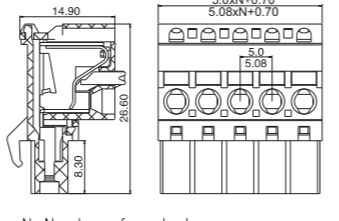
产品型号 MODEL	2EGTKDBM-5.0 2EGTKDBM-5.08	2EGTV-5.0 2EGTV-5.08	2EGTVC-5.0 2EGTVC-5.08
产品照片 Photo	 Pole:2-16P Pitch:5.0/5.08mm	 Pole:2-24P Pitch:5.0/5.08mm	 Pole:2-24P Pitch:5.0/5.08mm
产品图纸 Plan	 N=Number of contacts	 N=Number of contacts	 N=Number of contacts
材质/电镀 MATERIAL	塑件 Housing PA66,UL94V-0	塑件 Housing PA66,UL94V-0	塑件 Housing PA66,UL94V-0
焊针 Pin header	磷青铜 Phosphor bronze	黄铜,镀锡 Brass,Tin plated	黄铜,镀锡 Brass,Tin plated
簧片 Wire guard	不锈钢 Stainless steel	-	-
螺丝 Screws	M2.5,钢,镀Cr <sup>3+</sup> 钝化彩锌 M2.5,steel,Cr <sup>3+</sup> Zn plated	-	-
电气性能 ELECTRICAL	UL IEC	UL IEC	UL IEC
额定电压 Rated voltage	300V 320V	300V 320V	300V 320V
额定电流 Rated current	10A 20A	15A 20A	15A 20A
使用线径 Wire range	26~12AWG 2.5mm <sup>2</sup>	-	-

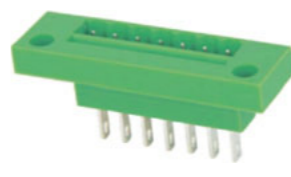
产品型号 MODEL	2EGTKDA-5.0 2EGTKDA-5.08	2EGTKDAM-5.0 2EGTKDAM-5.08	2EGTKDB-5.0 2EGTKDB-5.08
产品照片 Photo	 Pole:2-18P Pitch:5.0/5.08mm	 Pole:2-16P Pitch:5.0/5.08mm	 Pole:2-18P Pitch:5.0/5.08mm
产品图纸 Plan	 N=Number of contacts	 N=Number of contacts	 N=Number of contacts
材质/电镀 MATERIAL	塑件 Housing PA66,UL94V-0	塑件 Housing PA66,UL94V-0	塑件 Housing PA66,UL94V-0
触点材料 Contact	磷青铜 Phosphor bronze	磷青铜 Phosphor bronze	磷青铜 Phosphor bronze
簧片 Wire guard	不锈钢 Stainless steel	不锈钢 Stainless steel	不锈钢 Stainless steel
螺丝 Screws	-	M2.5,钢,镀Cr <sup>3+</sup> 钝化彩锌 M2.5,steel,Cr <sup>3+</sup> Zn plated	-
电气性能 ELECTRICAL	UL IEC	UL IEC	UL IEC
额定电压 Rated voltage	300V 320V	300V 320V	300V 320V
额定电流 Rated current	10A 20A	10A 20A	10A 20A
使用线径 Wire range	26~12AWG 2.5mm <sup>2</sup>	26~12AWG 2.5mm <sup>2</sup>	26~12AWG 2.5mm <sup>2</sup>

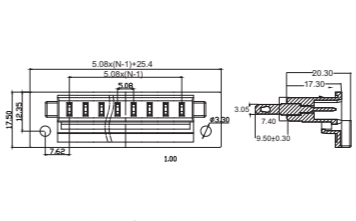
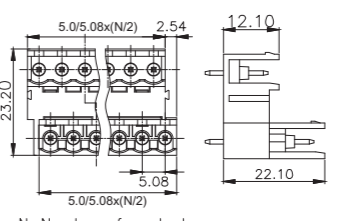
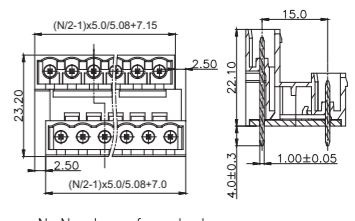
产品型号 MODEL	2EGTVC-5.08-CB	2EGTVT-5.0 2EGTVT-5.08	2EGTVC-5.0 2EGTVC-5.08
产品照片 Photo	 Pole:2-24P Pitch:5.08mm	 Pole:2*(2P3P-24P) Pitch:5.0/5.08mm	 Pole:2*(2P-24P) Pitch:5.0/5.08mm
产品图纸 Plan	 N=Number of contacts	 N=Number of contacts	 N=Number of contacts
材质/电镀 MATERIAL	塑件 Housing PA66,UL94V-0	塑件 Housing PA66,UL94V-0	塑件 Housing PA66,UL94V-0
焊针 Pin header	黄铜,镀锡 Brass,Tin plated	黄铜,镀锡 Brass,Tin plated	黄铜,镀锡 Brass,Tin plated
螺母 Nut	M2.5,黄铜 M2.5,Brass	-	-
电气性能 ELECTRICAL	UL IEC	UL IEC	UL IEC
额定电压 Rated voltage	300V 320V	300V 320V	300V 320V
额定电流 Rated current	15A 20A	15A 10A	15A 10A
使用线径 Wire range	-	-	-





产品型号 MODEL	2EGTVH-5.0 2EGTVH-5.08	2EGTVM-5.0 2EGTVM-5.08	2EGVTM-5.0 2EGVTM-5.08
产品照片 Photo			
产品图纸 Plan			
材质/电镀 MATERIAL	塑件 Housing PA66,UL94V-0 焊针 Pin header 黄铜,镀锡 Brass,Tin plated 螺母 Nut -	塑件 Housing PA66,UL94V-0 焊针 Pin header 黄铜,镀锡 Brass,Tin plated 螺母 Nut M2.5,黄铜 M2.5,Brass	塑件 Housing PA66,UL94V-0 焊针 Pin header 黄铜,镀锡 Brass,Tin plated 螺母 Nut M2.5,黄铜 M2.5,Brass
电气性能 ELECTRICAL	UL IEC 额定电压 Rated voltage 300V 320V 额定电流 Rated current 15A 10A 使用线径 Wire range -	UL IEC 额定电压 Rated voltage 300V 320V 额定电流 Rated current 15A 20A 使用线径 Wire range -	UL IEC 额定电压 Rated voltage 300V 320V 额定电流 Rated current 15A 10A 使用线径 Wire range -



产品型号 MODEL	2EGTRF-5.0	2EGTR-5.0 2EGTR-5.08	2EGTRC-5.0 2EGTRC-5.08
产品照片 Photo			
产品图纸 Plan			
材质/电镀 MATERIAL	塑件 Housing PA66,UL94V-0 焊针 Pin header 黄铜,镀锡 Brass,Tin plated 螺母 Nut -	塑件 Housing PA66,UL94V-0 焊针 Pin header 黄铜,镀锡 Brass,Tin plated 螺母 Nut -	塑件 Housing PA66,UL94V-0 焊针 Pin header 黄铜,镀锡 Brass,Tin plated 螺母 Nut -
电气性能 ELECTRICAL	UL IEC 额定电压 Rated voltage 300V 320V 额定电流 Rated current 15A 20A 使用线径 Wire range -	UL IEC 额定电压 Rated voltage 300V 320V 额定电流 Rated current 15A 20A 使用线径 Wire range -	UL IEC 额定电压 Rated voltage 300V 320V 额定电流 Rated current 15A 20A 使用线径 Wire range -



产品型号 MODEL	2EGTL-5.0 2EGTL-5.08	2EGTLC-5.0 2EGTLC-5.08	2EGTLF-5.0
产品照片 Photo			
产品图纸 Plan			
材质/电镀 MATERIAL	塑件 Housing PA66,UL94V-0 焊针 Pin header 黄铜,镀锡 Brass,Tin plated 螺母 Nut -	塑件 Housing PA66,UL94V-0 焊针 Pin header 黄铜,镀锡 Brass,Tin plated 螺母 Nut -	塑件 Housing PA66,UL94V-0 焊针 Pin header 黄铜,镀锡 Brass,Tin plated 螺母 Nut -
电气性能 ELECTRICAL	UL IEC 额定电压 Rated voltage 300V 320V 额定电流 Rated current 15A 20A 使用线径 Wire range -	UL IEC 额定电压 Rated voltage 300V 320V 额定电流 Rated current 15A 20A 使用线径 Wire range -	UL IEC 额定电压 Rated voltage 300V 320V 额定电流 Rated current 15A 20A 使用线径 Wire range -

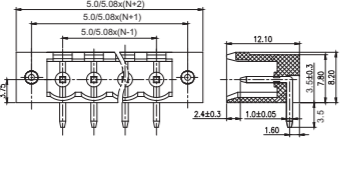
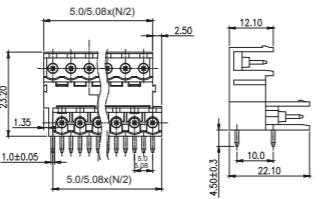
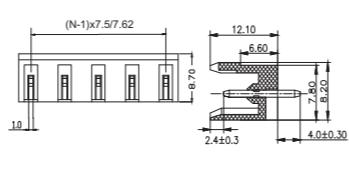

产品型号 MODEL	2EGTRT-5.0 2EGTRT-5.08	2EGTRTC-5.0 2EGTRTC-5.08	2EGTRH-5.0 2EGTRH-5.08
产品照片 Photo			
产品图纸 Plan			
材质/电镀 MATERIAL	塑件 Housing PA66,UL94V-0 焊针 Pin header 黄铜,镀锡 Brass,Tin plated 螺母 Nut -	塑件 Housing PA66,UL94V-0 焊针 Pin header 黄铜,镀锡 Brass,Tin plated 螺母 Nut -	塑件 Housing PA66,UL94V-0 焊针 Pin header 黄铜,镀锡 Brass,Tin plated 螺母 Nut -
电气性能 ELECTRICAL	UL IEC 额定电压 Rated voltage 300V 320V 额定电流 Rated current 15A 10A 使用线径 Wire range -	UL IEC 额定电压 Rated voltage 300V 320V 额定电流 Rated current 15A 10A 使用线径 Wire range -	UL IEC 额定电压 Rated voltage 300V 320V 额定电流 Rated current 15A 10A 使用线径 Wire range -

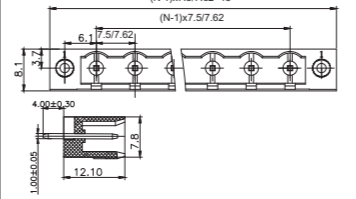
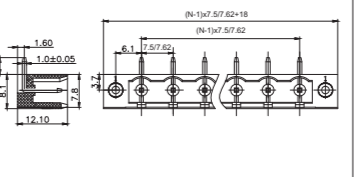
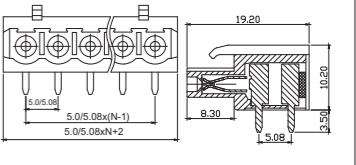

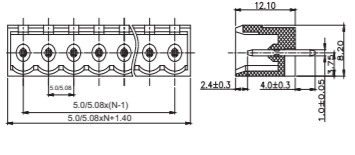
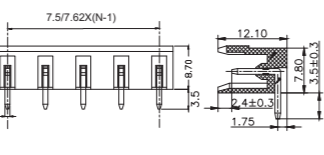
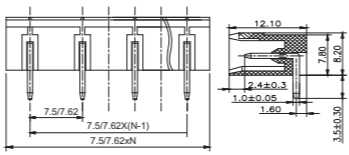

产品型号 MODEL	2EGTRM-5.0 2EGTRM-5.08	2EGTRTM-5.0 2EGTRTM-5.08	2EGTV-7.5 2EGTV-7.62
产品照片 Photo	 Pole:2-22P Pitch:5.0/5.08mm	 Pole:2*(2-22P) Pitch:5.0/5.08mm	 Pole:2-24P Pitch:7.5/7.62mm
产品图纸 Plan	 N=Number of contacts	 N=Number of contacts	 N=Number of contacts
材质/电镀 MATERIAL	塑件 Housing PA66,UL94V-0 焊针 Pin header 黄铜,镀锡 Brass,Tin plated 螺母 Nut M2.5,黄铜 M2.5,Brass	塑件 Housing PA66,UL94V-0 焊针 Pin header 黄铜,镀锡 Brass,Tin plated 螺母 Nut M2.5,黄铜 M2.5,Brass	塑件 Housing PA66,UL94V-0 焊针 Pin header 黄铜,镀锡 Brass,Tin plated 螺母 Nut -
电气性能 ELECTRICAL	UL IEC 额定电压 Rated voltage 300V 320V 额定电流 Rated current 15A 20A 使用线径 Wire range -	UL IEC 额定电压 Rated voltage 300V 320V 额定电流 Rated current 15A 10A 使用线径 Wire range -	UL IEC 额定电压 Rated voltage 300V 400V 额定电流 Rated current 15A 20A 使用线径 Wire range -

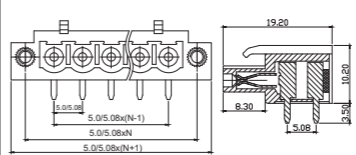
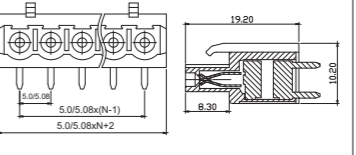
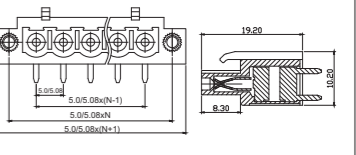

产品型号 MODEL	2EGTVM-7.5 2EGTVM-7.62	2EGTRM-7.5 2EGTRM-7.62	2EGTA-5.0 2EGTA-5.08
产品照片 Photo	 Pole:2-12P Pitch:7.5/7.62mm	 Pole:2-12P Pitch:7.5/7.62mm	 Pole:2-24P Pitch:5.0/5.08mm
产品图纸 Plan	 N=Number of contacts	 N=Number of contacts	 N=Number of contacts
材质/电镀 MATERIAL	塑件 Housing PA66,UL94V-0 触点材料 Contact 黄铜,镀锡 Brass,Tin plated 焊针 Pin header M2.5,黄铜 M2.5,Brass 螺母 Nut -	塑件 Housing PA66,UL94V-0 触点材料 Contact - 焊针 Pin header 黄铜,镀锡 Brass,Tin plated 螺母 Nut M2.5,黄铜 M2.5,Brass	塑件 Housing PA66,UL94V-0 触点材料 Contact 磷青铜,镀锡 Phosphor bronze,Tin plated 焊针 Pin header - 螺母 Nut -
电气性能 ELECTRICAL	UL IEC 额定电压 Rated voltage 300V 400V 额定电流 Rated current 15A 20A 使用线径 Wire range -	UL IEC 额定电压 Rated voltage 300V 400V 额定电流 Rated current 15A 20A 使用线径 Wire range -	UL IEC 额定电压 Rated voltage 300V 320V 额定电流 Rated current 15A 20A 使用线径 Wire range -



产品型号 MODEL	2EGTVC-7.5 2EGTVC-7.62	2EGTR-7.5 2EGTR-7.62	2EGTRC-7.5 2EGTRC-7.62
产品照片 Photo	 Pole:2-24P Pitch:7.5/7.62mm	 Pole:2-24P Pitch:7.5/7.62mm	 Pole:2-24P Pitch:7.5/7.62mm
产品图纸 Plan	 N=Number of contacts	 N=Number of contacts	 N=Number of contacts
材质/电镀 MATERIAL	塑件 Housing PA66,UL94V-0 焊针 Pin header 黄铜,镀锡 Brass,Tin plated 螺母 Nut -	塑件 Housing PA66,UL94V-0 焊针 Pin header 黄铜,镀锡 Brass,Tin plated 螺母 Nut -	塑件 Housing PA66,UL94V-0 焊针 Pin header 黄铜,镀锡 Brass,Tin plated 螺母 Nut -
电气性能 ELECTRICAL	UL IEC 额定电压 Rated voltage 300V 400V 额定电流 Rated current 15A 20A 使用线径 Wire range -	UL IEC 额定电压 Rated voltage 300V 400V 额定电流 Rated current 15A 20A 使用线径 Wire range -	UL IEC 额定电压 Rated voltage 300V 400V 额定电流 Rated current 15A 20A 使用线径 Wire range -

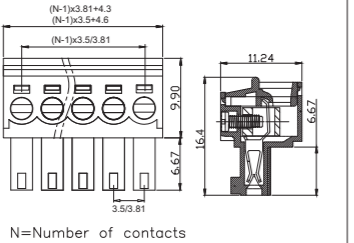
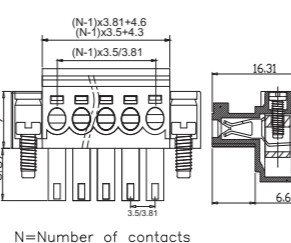
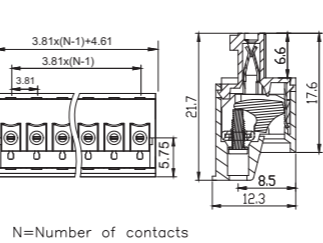

产品型号 MODEL	2EGTAM-5.0 2EGTAM-5.08	2EGTB-5.0 2EGTB-5.08	2EGTBM-5.0 2EGTBM-5.08
产品照片 Photo	 Pole:2-22P Pitch:5.0/5.08mm	 Pole:2-24P Pitch:5.0/5.08mm	 Pole:2-22P Pitch:5.0/5.08mm
产品图纸 Plan	 N=Number of contacts	 N=Number of contacts	 N=Number of contacts
材质/电镀 MATERIAL	塑件 Housing PA66,UL94V-0 触点材料 Contact 磷青铜,镀锡 Phosphor bronze,Tin plated 方盒 Cage - 螺母 Nut M2.5,黄铜 M2.5,Brass	塑件 Housing PA66,UL94V-0 触点材料 Contact 磷青铜,镀锡 Phosphor bronze,Tin plated 方盒 Cage - 螺母 Nut -	塑件 Housing PA66,UL94V-0 触点材料 Contact 磷青铜,镀锡 Phosphor bronze,Tin plated 方盒 Cage - 螺母 Nut M2.5,黄铜 M2.5,Brass
电气性能 ELECTRICAL	UL IEC 额定电压 Rated voltage 300V 320V 额定电流 Rated current 15A 20A 使用线径 Wire range -	UL IEC 额定电压 Rated voltage 300V 320V 额定电流 Rated current 15A 20A 使用线径 Wire range -	UL IEC 额定电压 Rated voltage 300V 320V 额定电流 Rated current 15A 20A 使用线径 Wire range -

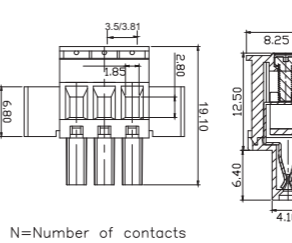
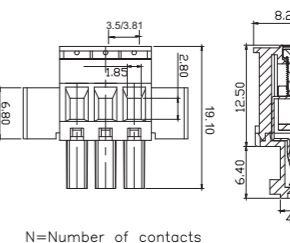
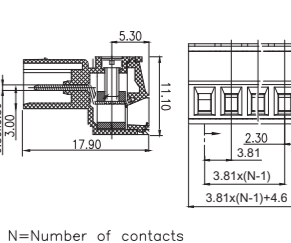

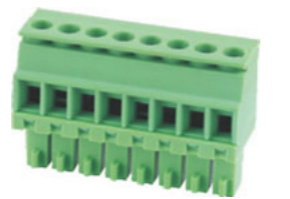

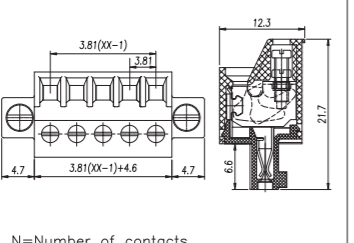
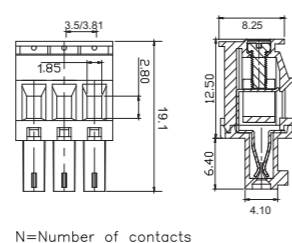
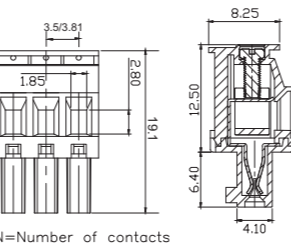
产品型号 MODEL	15EGTK-3.5 15EGTK-3.81	15EGTKM-3.5 15EGTKM-3.81	15EGTKC-3.81
产品照片 Photo			
产品图纸 Plan			
材质/电镀 MATERIAL	塑件 Housing PA66,UL94V-0 触点材料 Contact 磷青铜 Phosphor bronze 方盒 Cage 黄铜,镀镍 Brass,Ni plated 螺丝 Screws M2,钢,镀Cr <sup>3+</sup> 钝化彩锌 M2,steel,Cr <sup>3+</sup> Zn plated	塑件 Housing PA66,UL94V-0 触点材料 Contact 磷青铜 Phosphor bronze 方盒 Cage 黄铜,镀镍 Brass,Ni plated 螺丝 Screws M2,钢,镀Cr <sup>3+</sup> 钝化彩锌 M2,steel,Cr <sup>3+</sup> Zn plated	塑件 Housing PA66,UL94V-0 触点材料 Contact 磷青铜 Phosphor bronze 方盒 Cage 钢,镀Cr <sup>3+</sup> 钝化彩锌 Steel,Cr <sup>3+</sup> Zn plated 螺丝 Screws M2,钢,镀Cr <sup>3+</sup> 钝化彩锌 M2,steel,Cr <sup>3+</sup> Zn plated
电气性能 ELECTRICAL	UL IEC 额定电压 Rated voltage 300V 250V 额定电流 Rated current 8A 7A 使用线径 Wire range 28~16AWG 0.5~1.5mm <sup>2</sup>	UL IEC 额定电压 Rated voltage 300V 250V 额定电流 Rated current 8A 7A 使用线径 Wire range 28~16AWG 0.5~1.5mm <sup>2</sup>	UL IEC 额定电压 Rated voltage 300V 250V 额定电流 Rated current 8A 7A 使用线径 Wire range 28~16AWG 0.5~1.5mm <sup>2</sup>

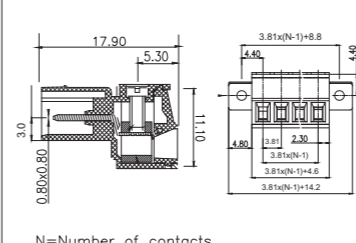
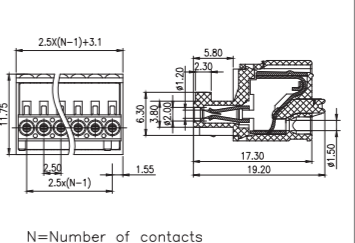
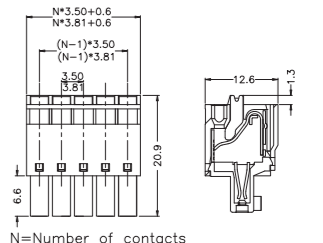

产品型号 MODEL	15EGTKAM-3.5 15EGTKAM-3.81	15EGTKBM-3.5 15EGTKBM-3.81	15EGTKR-3.81
产品照片 Photo			
产品图纸 Plan			
材质/电镀 MATERIAL	塑件 Housing PA66,UL94V-0 螺丝 Screws M2,钢,镀Cr <sup>3+</sup> 钝化彩锌 M2,steel,Cr <sup>3+</sup> Zn plated 触点材料 Contact 磷青铜 Phosphor bronze 方盒 Cage 黄铜,镀镍 Brass,Ni plated	塑件 Housing PA66,UL94V-0 螺丝 Screws M2,钢,镀Cr <sup>3+</sup> 钝化彩锌 M2,steel,Cr <sup>3+</sup> Zn plated 触点材料 Contact 磷青铜 Phosphor bronze 方盒 Cage 黄铜,镀镍 Brass,Ni plated	塑件 Housing PA66,UL94V-0 螺丝 Screws M2,钢,镀Cr <sup>3+</sup> 钝化彩锌 M2,steel,Cr <sup>3+</sup> Zn plated 触点材料 Contact 紫铜,镀锡 Copper,Tin Plated 方盒 Cage 黄铜,镀镍 Brass,Ni plated
电气性能 ELECTRICAL	UL IEC 额定电压 Rated voltage 300V 250V 额定电流 Rated current 8A 7A 使用线径 Wire range 28~16AWG 0.5~1.5mm <sup>2</sup>	UL IEC 额定电压 Rated voltage 300V 250V 额定电流 Rated current 8A 7A 使用线径 Wire range 28~16AWG 0.5~1.5mm <sup>2</sup>	UL IEC 额定电压 Rated voltage 300V 250V 额定电流 Rated current 8A 7A 使用线径 Wire range 28~16AWG 0.5~1.5mm <sup>2</sup>

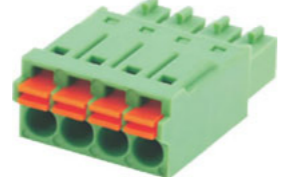

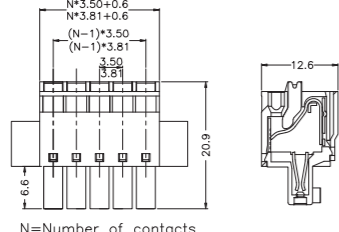
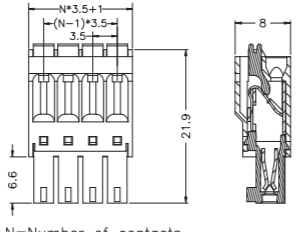
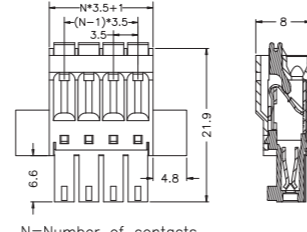
产品型号 MODEL	15EGTKCM-3.81	15EGTKA-3.5 15EGTKA-3.81	15EGTKB-3.5 15EGTKB-3.81
产品照片 Photo			
产品图纸 Plan			
材质/电镀 MATERIAL	塑件 Housing PA66,UL94V-0 螺丝 Screws M2,钢,镀Cr <sup>3+</sup> 钝化彩锌 M2,steel,Cr <sup>3+</sup> Zn plated 触点材料 Contact 磷青铜 Phosphor bronze 方盒 Cage 钢,镀Cr <sup>3+</sup> 钝化彩锌 Steel,Cr <sup>3+</sup> Zn plated	塑件 Housing PA66,UL94V-0 螺丝 Screws M2,钢,镀Cr <sup>3+</sup> 钝化彩锌 M2,steel,Cr <sup>3+</sup> Zn plated 触点材料 Contact 磷青铜 Phosphor bronze 方盒 Cage 黄铜,镀镍 Brass,Ni plated	塑件 Housing PA66,UL94V-0 螺丝 Screws M2,钢,镀Cr <sup>3+</sup> 钝化彩锌 M2,steel,Cr <sup>3+</sup> Zn plated 触点材料 Contact 磷青铜 Phosphor bronze 方盒 Cage 黄铜,镀镍 Brass,Ni plated
电气性能 ELECTRICAL	UL IEC 额定电压 Rated voltage 300V 250V 额定电流 Rated current 8A 7A 使用线径 Wire range 28~16AWG 0.5~1.5mm <sup>2</sup>	UL IEC 额定电压 Rated voltage 300V 250V 额定电流 Rated current 8A 7A 使用线径 Wire range 28~16AWG 0.5~1.5mm <sup>2</sup>	UL IEC 额定电压 Rated voltage 300V 250V 额定电流 Rated current 8A 7A 使用线径 Wire range 28~16AWG 0.5~1.5mm <sup>2</sup>

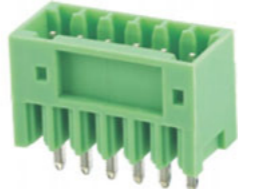
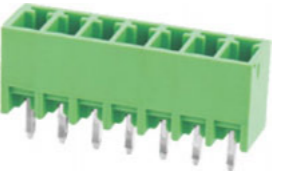
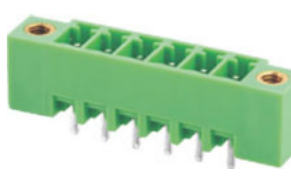
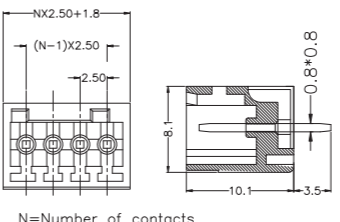
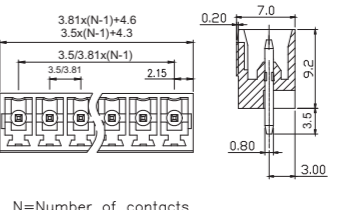
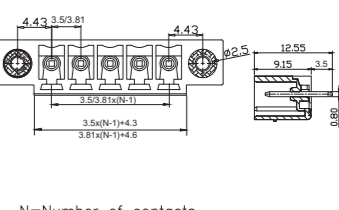
产品型号 MODEL	15EGTKRP-3.81	15EGTKD-2.5	15EGTKD-3.5 15EGTKD-3.81
产品照片 Photo			
产品图纸 Plan			
材质/电镀 MATERIAL	塑件 Housing PA66,UL94V-0 螺丝 Screws M2,钢,镀Cr <sup>3+</sup> 钝化彩锌 M2,steel,Cr <sup>3+</sup> Zn plated 触点材料 Contact 紫铜,镀锡 Copper,Tin Plated 方盒 Cage 黄铜,镀镍 Brass,Ni plated 簧片 Wire guard -	塑件 Housing PA66,UL94V-0 触点材料 Contact 磷青铜 Phosphor bronze 方盒 Cage 不锈钢 Stainless steel	塑件 Housing PA66,UL94V-0 触点材料 Contact 磷青铜 Phosphor bronze 方盒 Cage 不锈钢 Stainless steel
电气性能 ELECTRICAL	UL IEC 额定电压 Rated voltage 300V 250V 额定电流 Rated current 8A 7A 使用线径 Wire range 28~16AWG 0.5~1.5mm <sup>2</sup>	UL IEC 额定电压 Rated voltage 150V 250V 额定电流 Rated current 4A 5A 使用线径 Wire range 26~20AWG 0.2~0.5mm <sup>2</sup>	UL IEC 额定电压 Rated voltage 300V 250V 额定电流 Rated current 8A 12A 使用线径 Wire range 28~16AWG 0.2~1.5mm <sup>2</sup>

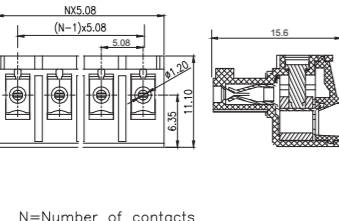
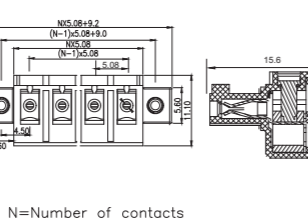

产品型号 MODEL	15EGTKDM-3.5 15EGTKDM-3.81	15EGTKN-3.5	15EGTKNM-3.5
产品照片 Photo			
产品图纸 Plan			
材质/电镀 MATERIAL	塑件 Housing PA66,UL94V-0 螺丝 Screws M2,钢,镀Cr <sup>3+</sup> 钝化彩锌 触点材料 Contact 磷青铜 簧片 Wire guard 不锈钢	塑件 Housing PA66,UL94V-0 螺丝 Screws M2,钢,镀Cr <sup>3+</sup> 钝化彩锌 触点材料 Contact 磷青铜 簧片 Wire guard 不锈钢	塑件 Housing PA66,UL94V-0 螺丝 Screws M2,钢,镀Cr <sup>3+</sup> 钝化彩锌 触点材料 Contact 磷青铜 簧片 Wire guard 不锈钢
电气性能 ELECTRICAL	UL IEC 额定电压 Rated voltage 300V 250V 额定电流 Rated current 8A 12A 使用线径 Wire range 28~16AWG 0.2~1.5mm <sup>2</sup>	UL IEC 额定电压 Rated voltage 300V 250V 额定电流 Rated current 8A 8A 使用线径 Wire range 28~16AWG 0.1~1.0mm <sup>2</sup>	UL IEC 额定电压 Rated voltage 300V 250V 额定电流 Rated current 8A 8A 使用线径 Wire range 28~16AWG 0.1~1.0mm <sup>2</sup>

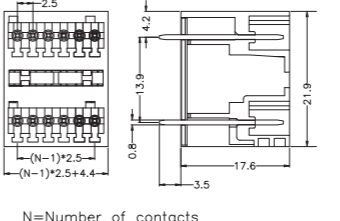
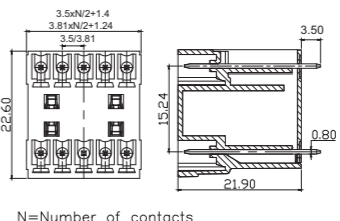
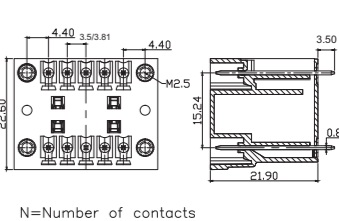

产品型号 MODEL	15EGTVC-2.5	15EGTVC-3.5 15EGTVC-3.81	15EGTVM-3.5 15EGTVM-3.81
产品照片 Photo			
产品图纸 Plan			
材质/电镀 MATERIAL	塑件 Housing PA66,UL94V-0 焊针 Pin header 黄铜,镀锡 螺母 Nut -	塑件 Housing PA66,UL94V-0 焊针 Pin header 黄铜,镀锡 螺母 Nut -	塑件 Housing PA66,UL94V-0 焊针 Pin header 黄铜,镀锡 螺母 Nut M2.5,黄铜
电气性能 ELECTRICAL	UL IEC 额定电压 Rated voltage 150V 250V 额定电流 Rated current 4A 5A 使用线径 Wire range -	UL IEC 额定电压 Rated voltage 300V 250V 额定电流 Rated current 8A 7A 使用线径 Wire range -	UL IEC 额定电压 Rated voltage 300V 250V 额定电流 Rated current 8A 7A 使用线径 Wire range -



产品型号 MODEL	15EGTK-5.08	15EGTKM-5.08	
产品照片 Photo			
产品图纸 Plan			
材质/电镀 MATERIAL	塑件 Housing PA66,UL94V-0 螺丝 Screws M2,钢,镀Cr <sup>3+</sup> 钝化彩锌 触点材料 Contact 磷青铜 簧片 Wire guard 黄铜,镀镍 方盒 Cage 黄铜,镀镍	塑件 Housing PA66,UL94V-0 螺丝 Screws M2,钢,镀Cr <sup>3+</sup> 钝化彩锌 触点材料 Contact 磷青铜 簧片 Wire guard 黄铜,镀镍 方盒 Cage 黄铜,镀镍	
电气性能 ELECTRICAL	UL IEC 额定电压 Rated voltage 300V 450V 额定电流 Rated current 8A 7A 使用线径 Wire range 28~16AWG 0.5~1.5mm <sup>2</sup>	UL IEC 额定电压 Rated voltage 300V 450V 额定电流 Rated current 8A 7A 使用线径 Wire range 28~16AWG 0.5~1.5mm <sup>2</sup>	

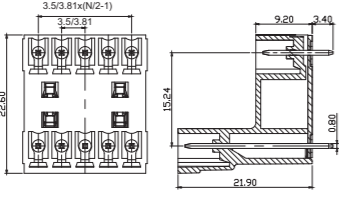
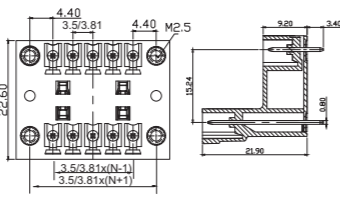
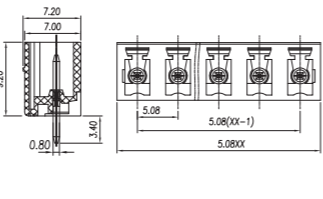

产品型号 MODEL	15EGTVH-2.5	15EGTVH-3.5 15EGTVH-3.81	15EGTVHM-3.5 15EGTVHM-3.81
产品照片 Photo			
产品图纸 Plan			
材质/电镀 MATERIAL	塑件 Housing PA66,UL94V-0 焊针 Pin header 黄铜,镀锡 螺母 Nut -	塑件 Housing PA66,UL94V-0 焊针 Pin header 黄铜,镀锡 螺母 Nut -	塑件 Housing PA66,UL94V-0 焊针 Pin header 黄铜,镀锡 螺母 Nut M2.5,黄铜
电气性能 ELECTRICAL	UL IEC 额定电压 Rated voltage 150V 250V 额定电流 Rated current 5A 5A 使用线径 Wire range -	UL IEC 额定电压 Rated voltage 300V 250V 额定电流 Rated current 8A 7A 使用线径 Wire range -	UL IEC 额定电压 Rated voltage 300V 250V 额定电流 Rated current 8A 7A 使用线径 Wire range -

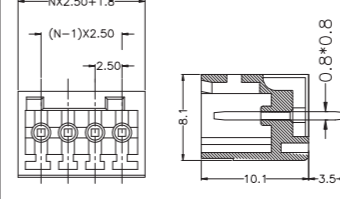
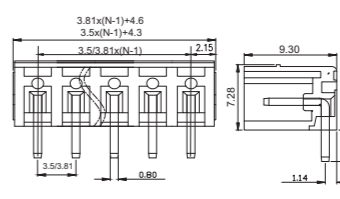
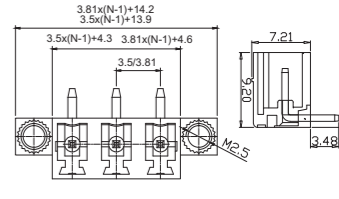

产品型号 MODEL	15EGTVT-3.5 15EGTVT-3.81	15EGVTM-3.5 15EGVTM-3.81	15EGTVC-5.08
产品照片 Photo			
产品图纸 Plan			
材质/电镀 MATERIAL	塑件 Housing PA66,UL94V-0 焊针 Pin header 黄铜,镀锡 Brass,Tin plated 螺母 Nut -	塑件 Housing PA66,UL94V-0 焊针 Pin header 黄铜,镀锡 Brass,Tin plated 螺母 Nut M2.5,黄铜 M2.5,Brass	塑件 Housing PA66,UL94V-0 焊针 Pin header 黄铜,镀锡 Brass,Tin plated 螺母 Nut -
电气性能 ELECTRICAL	UL IEC 额定电压 Rated voltage 300V 250V 额定电流 Rated current 8A 7A 使用线径 Wire range -	UL IEC 额定电压 Rated voltage 300V 250V 额定电流 Rated current 8A 7A 使用线径 Wire range -	UL IEC 额定电压 Rated voltage 300V 450V 额定电流 Rated current 8A 7A 使用线径 Wire range -

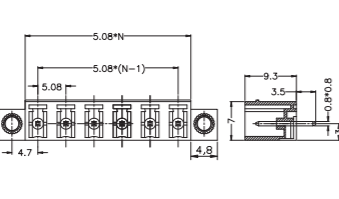
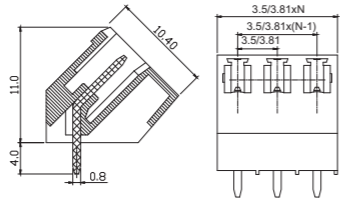
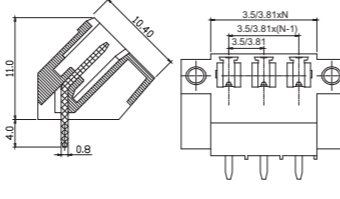
产品型号 MODEL	15EGTRC-2.5	15EGTRC-3.5 15EGTRC-3.81	15EGTRM-3.5 15EGTRM-3.81
产品照片 Photo			
产品图纸 Plan			
材质/电镀 MATERIAL	塑件 Housing PA66,UL94V-0 焊针 Pin header 黄铜,镀锡 Brass,Tin plated 螺母 Nut -	塑件 Housing PA66,UL94V-0 焊针 Pin header 黄铜,镀锡 Brass,Tin plated 螺母 Nut -	塑件 Housing PA66,UL94V-0 焊针 Pin header 黄铜,镀锡 Brass,Tin plated 螺母 Nut M2.5,黄铜 M2.5,Brass
电气性能 ELECTRICAL	UL IEC 额定电压 Rated voltage 150V 250V 额定电流 Rated current 4A 5A 使用线径 Wire range -	UL IEC 额定电压 Rated voltage 300V 250V 额定电流 Rated current 8A 7A 使用线径 Wire range -	UL IEC 额定电压 Rated voltage 300V 250V 额定电流 Rated current 8A 7A 使用线径 Wire range -

产品型号 MODEL	15EGTVM-5.08	15EGTLC-3.5 15EGTLC-3.81	15EGTLM-3.5 15EGTLM-3.81
产品照片 Photo			
产品图纸 Plan			
材质/电镀 MATERIAL	塑件 Housing PA66,UL94V-0 焊针 Pin header 黄铜,镀锡 Brass,Tin plated 螺母 Nut M2.5,黄铜 M2.5,Brass	塑件 Housing PA66,UL94V-0 焊针 Pin header 黄铜,镀锡 Brass,Tin plated 螺母 Nut -	塑件 Housing PA66,UL94V-0 焊针 Pin header 黄铜,镀锡 Brass,Tin plated 螺母 Nut M2.5,黄铜 M2.5,Brass
电气性能 ELECTRICAL	UL IEC 额定电压 Rated voltage 300V 450V 额定电流 Rated current 8A 7A 使用线径 Wire range -	UL IEC 额定电压 Rated voltage 300V 250V 额定电流 Rated current 8A 7A 使用线径 Wire range -	UL IEC 额定电压 Rated voltage 300V 250V 额定电流 Rated current 8A 7A 使用线径 Wire range -

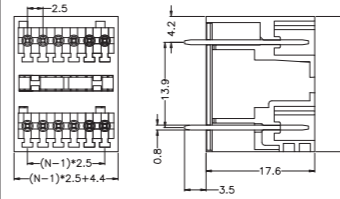
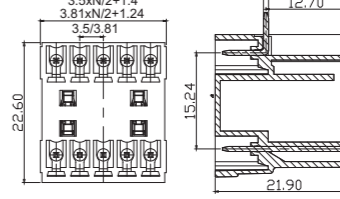
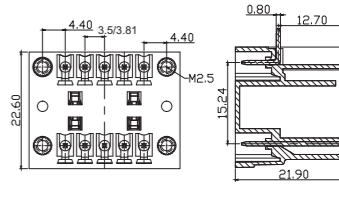
产品型号 MODEL	15EGTRH-2.5	15EGTRH-3.5 15EGTRH-3.81	15EGTRHM-3.5 15EGTRHM-3.81
产品照片 Photo			
产品图纸 Plan			
材质/电镀 MATERIAL	塑件 Housing PA66,UL94V-0 焊针 Pin header 黄铜,镀锡 Brass,Tin plated 螺母 Nut -	塑件 Housing PA66,UL94V-0 焊针 Pin header 黄铜,镀锡 Brass,Tin plated 螺母 Nut -	塑件 Housing PA66,UL94V-0 焊针 Pin header 黄铜,镀锡 Brass,Tin plated 螺母 Nut M2.5,黄铜 M2.5,Brass
电气性能 ELECTRICAL	UL IEC 额定电压 Rated voltage 150V 250V 额定电流 Rated current 5A 5A 使用线径 Wire range -	UL IEC 额定电压 Rated voltage 300V 250V 额定电流 Rated current 8A 7A 使用线径 Wire range -	UL IEC 额定电压 Rated voltage 300V 250V 额定电流 Rated current 8A 7A 使用线径 Wire range -

产品型号 MODEL	15EGTRT-3.5 15EGTRT-3.81	15EGTRTM-3.5 15EGTRTM-3.81	15EGTA-3.5 15EGTA-3.81
产品照片 Photo			
产品图纸 Plan			
材质/电镀 MATERIAL	塑件 Housing PA66,UL94V-0 触点材料 Contact - 焊针 Pin header 黄铜,镀锡 Brass,Tin plated 螺母 Nut -	塑件 Housing PA66,UL94V-0 触点材料 Contact 黄铜,镀锡 Brass,Tin plated 焊针 Pin header M2.5,黄铜 M2.5,Brass 螺母 Nut -	塑件 Housing PA66,UL94V-0 触点材料 Contact 磷青铜,镀锡 Phosphor bronze, Tin plated 焊针 Pin header - 螺母 Nut -
电气性能 ELECTRICAL	UL IEC 300V 250V 8A 7A	UL IEC 300V 250V 8A 7A	UL IEC 300V 250V 8A 7A
额定电压 Rated voltage	300V	300V	300V
额定电流 Rated current	8A	8A	8A
使用线径 Wire range	-	-	-

产品型号 MODEL	15EGTRM-5.08	2EGT-PWI	2EGT-PWP
产品照片 Photo			
产品图纸 Plan			
材质/电镀 MATERIAL	塑件 Housing PA66,UL94V-0 螺母 Nut M2.5,黄铜 M2.5,Brass 焊针 Pin header 黄铜,镀锡 Brass,Tin plated 螺母 Nut -	塑件 Housing PA66,UL94V-0 螺母 Nut - 焊针 Pin header - 螺母 Nut -	塑件 Housing PA66,UL94V-0 螺母 Nut - 焊针 Pin header - 螺母 Nut -
电气性能 ELECTRICAL	UL IEC 300V 450V 8A 7A	UL IEC 300V 450V 8A 7A	UL IEC 300V 450V 8A 7A
额定电压 Rated voltage	300V	300V	300V
额定电流 Rated current	8A	8A	8A
使用线径 Wire range	-	-	-

产品型号 MODEL	15EGTB-3.5 15EGTB-3.81	15EGTVC-3.81-CB	15EGTRC-5.08
产品照片 Photo			
产品图纸 Plan			
材质/电镀 MATERIAL	塑件 Housing PA66,UL94V-0 焊针 Pin header 磷青铜,镀锡 Phosphor bronze, Tin plated 螺母 Nut -	塑件 Housing PA66,UL94V-0 焊针 Pin header 磷青铜,镀锡 Phosphor bronze, Tin plated 螺母 Nut M2.5,黄铜 M2.5,Brass	塑件 Housing PA66,UL94V-0 焊针 Pin header 黄铜,镀锡 Brass,Tin plated 螺母 Nut -
电气性能 ELECTRICAL	UL IEC 300V 250V 8A 7A	UL IEC 300V 250V 8A 7A	UL IEC 300V 450V 8A 7A
额定电压 Rated voltage	300V	300V	300V
额定电流 Rated current	8A	8A	8A
使用线径 Wire range	-	-	-

产品型号 MODEL	5EGTK-7.62	5EGTKM-7.62	5EGTK-10.16
产品照片 Photo			
产品图纸 Plan			
材质/电镀 MATERIAL	塑件 Housing PA66,UL94V-0 螺丝 Screws M3,钢,镀Cr <sup>3+</sup> 钝化彩锌 M3,steel,Cr <sup>3+</sup> Zn plated 触点材料 Contact 磷青铜,镀锡 Phosphor bronze, Tin plated 方盒 Cage 黄铜,镀镍 Brass,Ni plated	塑件 Housing PA66,UL94V-0 螺丝 Screws M3,钢,镀Cr <sup>3+</sup> 钝化彩锌 M3,steel,Cr <sup>3+</sup> Zn plated 触点材料 Contact 磷青铜,镀锡 Phosphor bronze, Tin plated 方盒 Cage 黄铜,镀镍 Brass,Ni plated	塑件 Housing PA66,UL94V-0 螺丝 Screws M4,钢,镀Cr <sup>3+</sup> 钝化彩锌 M4,steel,Cr <sup>3+</sup> Zn plated 触点材料 Contact 磷青铜,镀锡 Phosphor bronze, Tin plated 方盒 Cage 黄铜,镀镍 Brass,Ni plated
电气性能 ELECTRICAL	UL IEC 300V 400V 30A 32A	UL IEC 300V 400V 30A 32A	UL IEC 600V 600V 52A 57A
额定电压 Rated voltage	300V	300V	600V
额定电流 Rated current	30A	30A	52A
使用线径 Wire range	24~10AWG	0.2~4.0mm <sup>2</sup>	20~7AWG



产品型号 MODEL	5EGTKM-10.16	5EGTVC-7.62	5EGTVC-10.16
产品照片 Photo			
产品图纸 Plan			
材质/电镀 MATERIAL	PA66,UL94V-0	PA66,UL94V-0	PA66,UL94V-0
塑件 Housing	-	黄铜,镀锡 Brass, Tin plated	黄铜,镀锡 Brass, Tin plated
焊针 Pin header	-	-	-
螺丝 Screws	M4,钢,镀Cr <sup>3+</sup> 钝化彩锌 M4, steel, Cr <sup>3+</sup> Zn plated	-	-
触点材料 Contact	磷青铜,镀锡 Phosphor bronze, Tin plated	-	-
方盒 Cage	黄铜,镀镍 Brass, Ni plated	-	-
电气性能 ELECTRICAL	UL IEC	UL IEC	UL IEC
额定电压 Rated voltage	600V 600V	300V 400V	300V 600V
额定电流 Rated current	52A 57A	30A 32A	52A 57A
使用线径 Wire range	20~7AWG 0.5~10.0mm <sup>2</sup>	-	-

产品型号 MODEL	5EGTVM-10.16	5EGTRC-7.62/10.16	5EGTRM-10.16
产品照片 Photo			
产品图纸 Plan			
材质/电镀 MATERIAL	PA66,UL94V-0	PA66,UL94V-0	PA66,UL94V-0
塑件 Housing	-	黄铜,镀锡 Brass, Tin plated	黄铜,镀锡 Brass, Tin plated
焊针 Pin header	黄铜,镀锡 Brass, Tin plated	-	-
螺母 Nut	黄铜 Brass	-	-
电气性能 ELECTRICAL	UL IEC	UL IEC	UL IEC
额定电压 Rated voltage	300V 600V	300V 400V/600V	300V 600V
额定电流 Rated current	52A 57A	30A/52A 32A/57A	52A 57A
使用线径 Wire range	-	-	-

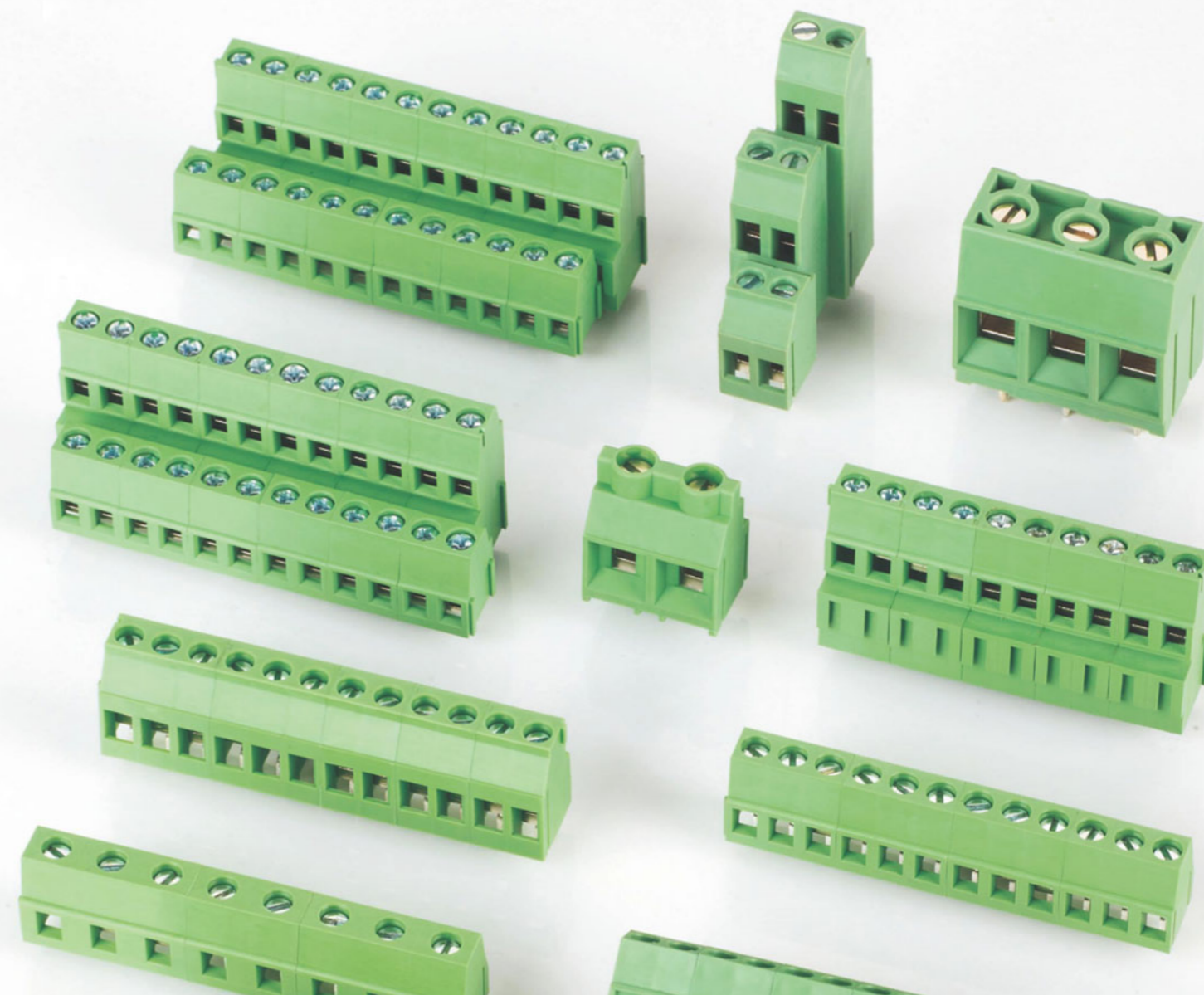







## PCB螺钉式接线端子 PCB Screw Terminal Blocks

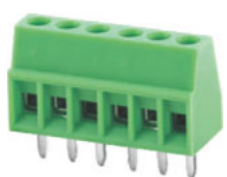

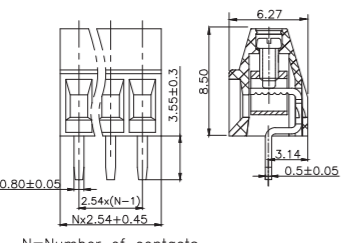
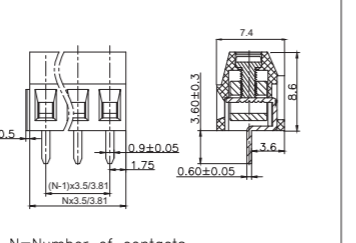
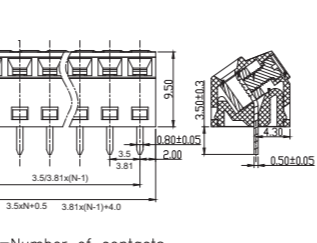
PCB螺钉式接线端子的间距3.5mm、3.81mm、5.0mm、5.08mm、6.35mm、7.5mm、7.62mm、9.5mm、10.0mm、10.16mm，并有90°、135°、180°等三种进线方向，配合单层、双层和三层的设计，使应用的选择性多样化。产品设计符合IE60998，UL1059等国际标准并通过UL等认证。



PCB screw terminal blocks can be soldered directly onto a PCB, which have different pitches from 3.5mm to 10.16mm. Different wiring angles at 90°, 135°, 180° could accommodate single-, dual-, or triple-layered designs and increase application diversity. Most of PCB screw terminal block series provide 2p and 3p bases and can be combined into any pole number. The product is designed comply with international quality standards, such as IEC60998 and UI1059.

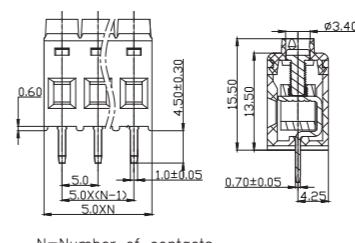
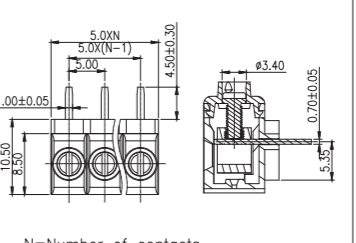
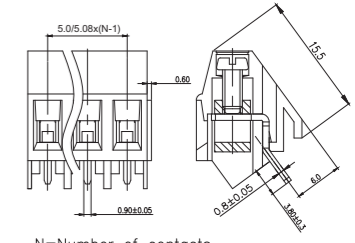

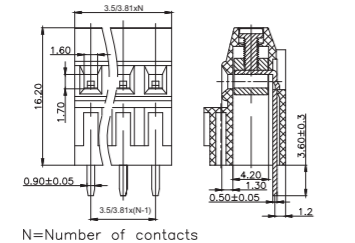
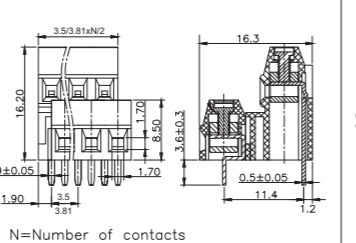
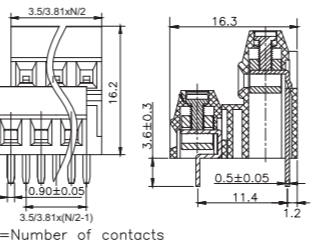

产品型号 MODEL	GT308-2.54	GT381-3.5 GT381-3.81	GT381S-3.5 GT381S-3.81
产品照片 Photo			
产品图纸 Plan			
材质/电镀 MATERIAL	塑件 Housing PA66,UL94V-0 螺丝 Screws M1.6,钢,镀Cr <sup>3+</sup> 钝化彩锌 M1.6,steel,Cr <sup>3+</sup> Zn plated 焊针 Pin header 黄铜,镀锡 Brass,Tin plated 方盒 Cage 黄铜,镀镍 Brass,Ni plated	塑件 Housing PA66,UL94V-0 螺丝 Screws M2,钢,镀Cr <sup>3+</sup> 钝化彩锌 M2,steel,Cr <sup>3+</sup> Zn plated 焊针 Pin header 黄铜,镀锡 Brass,Tin plated 方盒 Cage 黄铜,镀镍 Brass,Ni plated	塑件 Housing PA66,UL94V-0 螺丝 Screws M2,钢,镀Cr <sup>3+</sup> 钝化彩锌 M2,steel,Cr <sup>3+</sup> Zn plated 焊针 Pin header 黄铜,镀锡 Brass,Tin plated 方盒 Cage 黄铜,镀镍 Brass,Ni plated
电气性能 ELECTRICAL	UL IEC 额定电压 Rated voltage 150V 130V 额定电流 Rated current 6A 8A 使用线径 Wire range 28~18AWG 1.0mm <sup>2</sup>	UL IEC 额定电压 Rated voltage 150V,300V 130V 额定电流 Rated current 10A 10A 使用线径 Wire range 26~16AWG 1.0mm <sup>2</sup>	UL IEC 额定电压 Rated voltage 300V 130V 额定电流 Rated current 10A 10A 使用线径 Wire range 26~16AWG 0.2~1.5mm <sup>2</sup>

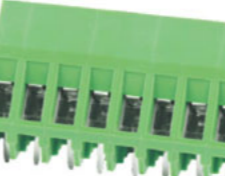

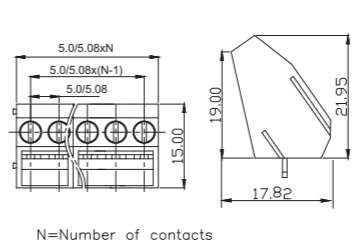
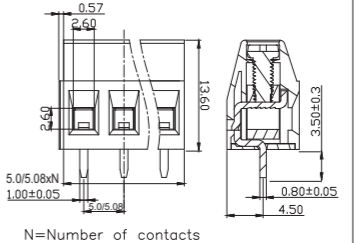
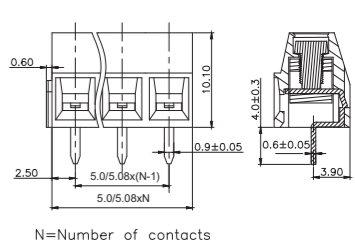
产品型号 MODEL	GT632-5.0	GT632R-5.0	GT103-5.0 GT103-5.08
产品照片 Photo			
产品图纸 Plan			
材质/电镀 MATERIAL	塑件 Housing PA66,UL94V-0 螺丝 Screws M2.5,钢,镀Cr <sup>3+</sup> 钝化彩锌 M2.5,steel,Cr <sup>3+</sup> Zn plated 焊针 Pin header 黄铜,镀锡 Brass,Tin plated 方盒 Cage 黄铜,镀镍 Brass,Ni plated	塑件 Housing PA66,UL94V-0 螺丝 Screws M2.5,钢,镀Cr <sup>3+</sup> 钝化彩锌 M2.5,steel,Cr <sup>3+</sup> Zn plated 焊针 Pin header 黄铜,镀锡 Brass,Tin plated 方盒 Cage 黄铜,镀镍 Brass,Ni plated	塑件 Housing PA66,UL94V-0 螺丝 Screws M2.5,钢,镀Cr <sup>3+</sup> 钝化彩锌 M2.5,steel,Cr <sup>3+</sup> Zn plated 焊针 Pin header 黄铜,镀锡 Brass,Tin plated 方盒 Cage 黄铜,镀镍 Brass,Ni plated
电气性能 ELECTRICAL	UL IEC 额定电压 Rated voltage 300V 250V 额定电流 Rated current 15A 24A 使用线径 Wire range 28~12AWG 0.5~2.5mm <sup>2</sup>	UL IEC 额定电压 Rated voltage 300V 250V 额定电流 Rated current 15A 24A 使用线径 Wire range 28~12AWG 0.5~2.5mm <sup>2</sup>	UL IEC 额定电压 Rated voltage 300V 250V 额定电流 Rated current 10A 24A 使用线径 Wire range 24~12AWG 2.5mm <sup>2</sup>



产品型号 MODEL	GT381H-3.5 GT381H-3.81	GT381A-3.5 GT381A-3.81	GT381B-3.5 GT381B-3.81
产品照片 Photo			
产品图纸 Plan			
材质/电镀 MATERIAL	塑件 Housing PA66,UL94V-0 螺丝 Screws M2,钢,镀Cr <sup>3+</sup> 钝化彩锌 M2,steel,Cr <sup>3+</sup> Zn plated 焊针 Pin header 黄铜,镀锡 Brass,Tin plated 方盒 Cage 黄铜,镀镍 Brass,Ni plated	塑件 Housing PA66,UL94V-0 螺丝 Screws M2,钢,镀Cr <sup>3+</sup> 钝化彩锌 M2,steel,Cr <sup>3+</sup> Zn plated 焊针 Pin header 黄铜,镀锡 Brass,Tin plated 方盒 Cage 黄铜,镀镍 Brass,Ni plated	塑件 Housing PA66,UL94V-0 螺丝 Screws M2,钢,镀Cr <sup>3+</sup> 钝化彩锌 M2,steel,Cr <sup>3+</sup> Zn plated 焊针 Pin header 黄铜,镀锡 Brass,Tin plated 方盒 Cage 黄铜,镀镍 Brass,Ni plated
电气性能 ELECTRICAL	UL IEC 额定电压 Rated voltage 150V 130V 额定电流 Rated current 10A 10A 使用线径 Wire range 26~16AWG 1.0mm <sup>2</sup>	UL IEC 额定电压 Rated voltage 300V 130V 额定电流 Rated current 12A 10A 使用线径 Wire range 26~16AWG 1.0mm <sup>2</sup>	UL IEC 额定电压 Rated voltage 300V 130V 额定电流 Rated current 12A 10A 使用线径 Wire range 26~16AWG 1.0mm <sup>2</sup>

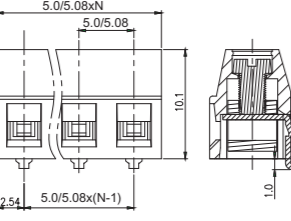
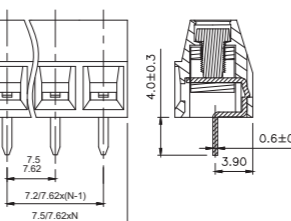
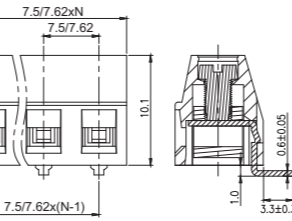

产品型号 MODEL	GT104-5.0 GT104-5.08	GT125-5.0 GT125-5.08	GT127-5.0 GT127-5.08
产品照片 Photo			
产品图纸 Plan			
材质/电镀 MATERIAL	塑件 Housing PA66,UL94V-0 螺丝 Screws M3,钢,镀Cr <sup>3+</sup> 钝化彩锌 M2,steel,Cr <sup>3+</sup> Zn plated 焊针 Pin header 黄铜,镀锡 Brass,Tin plated 方盒 Cage 黄铜,镀镍 Brass,Ni plated	塑件 Housing PA66,UL94V-0 螺丝 Screws M2.5,钢,镀Cr <sup>3+</sup> 钝化彩锌 M2.5,steel,Cr <sup>3+</sup> Zn plated 焊针 Pin header 黄铜,镀锡 Brass,Tin plated 方盒 Cage 黄铜,镀镍 Brass,Ni plated	塑件 Housing PA66,UL94V-0 螺丝 Screws M2.5,钢,镀Cr <sup>3+</sup> 钝化彩锌 M2.5,steel,Cr <sup>3+</sup> Zn plated 焊针 Pin header 黄铜,镀锡 Brass,Tin plated 方盒 Cage 黄铜,镀镍 Brass,Ni plated
电气性能 ELECTRICAL	UL IEC 额定电压 Rated voltage 300V 250V 额定电流 Rated current 15A 24A 使用线径 Wire range 24~14AWG 0.5~2.5mm <sup>2</sup>	UL IEC 额定电压 Rated voltage 300V 250V 额定电流 Rated current 12A 18A 使用线径 Wire range 26~12AWG 0.5~2.5mm <sup>2</sup>	UL IEC 额定电压 Rated voltage 300V 250V 额定电流 Rated current 12A 15A 使用线径 Wire range 26~14AWG 1.5mm <sup>2</sup>

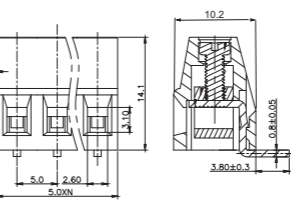
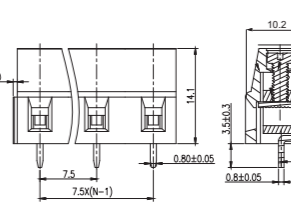
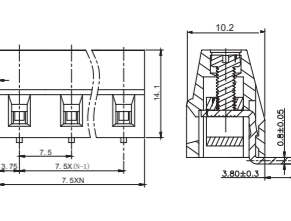



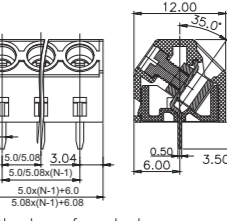
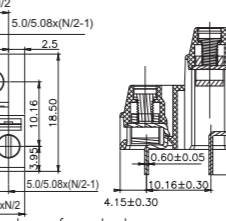
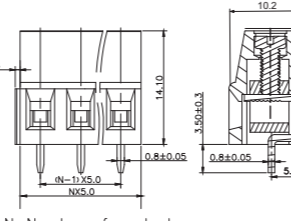

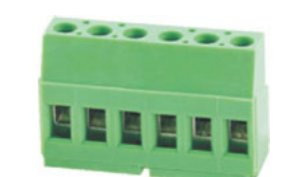

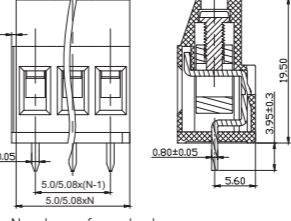
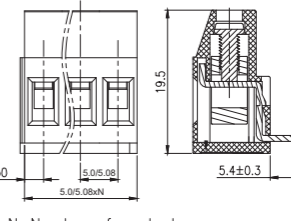
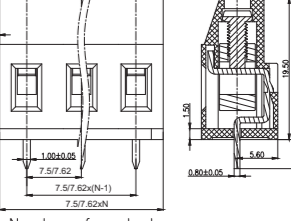
产品型号 MODEL	GT127R-5.0 GT127R-5.08	GT127-7.5 GT127-7.62	GT127R-7.5 GT127R-7.62
产品照片 Photo	 Pole:2P3P-24P Pitch:5.0/5.08mm	 Pole:2P3P-24P Pitch:7.5/7.62mm	 Pole:2P3P-24P Pitch:7.5/7.62mm
产品图纸 Plan	 N=Number of contacts	 N=Number of contacts	 N=Number of contacts
材质/电镀 MATERIAL	塑件 Housing PA66,UL94V-0	塑件 Housing PA66,UL94V-0	塑件 Housing PA66,UL94V-0
螺丝 Screws	M2.5,钢,镀Cr <sup>3+</sup> 钝化彩锌 M2.5,steel,Cr <sup>3+</sup> Zn plated	M2.5,钢,镀Cr <sup>3+</sup> 钝化彩锌 M2.5,steel,Cr <sup>3+</sup> Zn plated	M2.5,钢,镀Cr <sup>3+</sup> 钝化彩锌 M2.5,steel,Cr <sup>3+</sup> Zn plated
焊针 Pin header	黄铜,镀锡 Brass,Tin plated	黄铜,镀锡 Brass,Tin plated	黄铜,镀锡 Brass,Tin plated
方盒 Cage	黄铜,镀镍 Brass,Ni plated	黄铜,镀镍 Brass,Ni plated	黄铜,镀镍 Brass,Ni plated
电气性能 ELECTRICAL	UL IEC	UL IEC	UL IEC
额定电压 Rated voltage	300V 250V	300V 450V	300V 450V
额定电流 Rated current	12A 15A	12A 15A	12A 15A
使用线径 Wire range	26~14AWG 1.5mm <sup>2</sup>	26~14AWG 1.5mm <sup>2</sup>	26~14AWG 1.5mm <sup>2</sup>

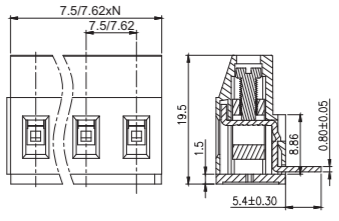
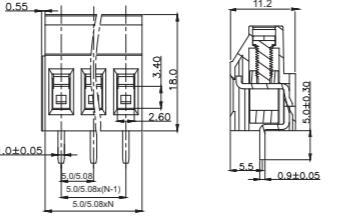
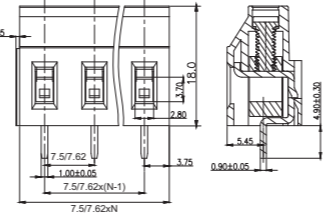

产品型号 MODEL	GT128R-5.0	GT128-7.5	GT128R-7.5
产品照片 Photo	 Pole:2P3P-24P Pitch:5.0mm	 Pole:2P3P-24P Pitch:7.5mm	 Pole:2P3P-24P Pitch:7.5mm
产品图纸 Plan	 N=Number of contacts	 N=Number of contacts	 N=Number of contacts
材质/电镀 MATERIAL	塑件 Housing PA66,UL94V-0	塑件 Housing PA66,UL94V-0	塑件 Housing PA66,UL94V-0
螺丝 Screws	M2.5,钢,镀Cr <sup>3+</sup> 钝化彩锌 M2.5,steel,Cr <sup>3+</sup> Zn plated	M2.5,钢,镀Cr <sup>3+</sup> 钝化彩锌 M2.5,steel,Cr <sup>3+</sup> Zn plated	M2.5,钢,镀Cr <sup>3+</sup> 钝化彩锌 M2.5,steel,Cr <sup>3+</sup> Zn plated
焊针 Pin header	黄铜,镀锡 Brass,Tin plated	黄铜,镀锡 Brass,Tin plated	黄铜,镀锡 Brass,Tin plated
方盒 Cage	黄铜,镀镍 Brass,Ni plated	黄铜,镀镍 Brass,Ni plated	黄铜,镀镍 Brass,Ni plated
电气性能 ELECTRICAL	UL IEC	UL IEC	UL IEC
额定电压 Rated voltage	300V 250V	300V 450V	300V 450V
额定电流 Rated current	15A 18A	15A 18A	15A 18A
使用线径 Wire range	24~12AWG 2.5mm <sup>2</sup>	24~12AWG 2.5mm <sup>2</sup>	24~12AWG 2.5mm <sup>2</sup>

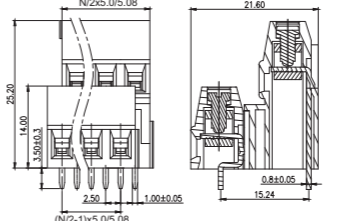
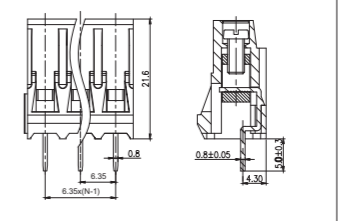
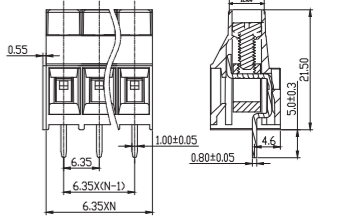

产品型号 MODEL	GT127S-5.0 GT127S-5.08	GT127A-5.0 GT127A-5.08	GT128-5.0
产品照片 Photo	 Pole:2-16P Pitch:5.0/5.08mm	 Pole:2*(2P-24P) Pitch:5.0/5.08mm	 Pole:2P3P-24P Pitch:5.0mm
产品图纸 Plan	 N=Number of contacts	 N=Number of contacts	 N=Number of contacts
材质/电镀 MATERIAL	塑件 Housing PA66,UL94V-0	塑件 Housing PA66,UL94V-0	塑件 Housing PA66,UL94V-0
螺丝 Screws	M2.5,钢,镀Cr <sup>3+</sup> 钝化彩锌 M2.5,steel,Cr <sup>3+</sup> Zn plated	M2.5,钢,镀Cr <sup>3+</sup> 钝化彩锌 M2.5,steel,Cr <sup>3+</sup> Zn plated	M2.5,钢,镀Cr <sup>3+</sup> 钝化彩锌 M2.5,steel,Cr <sup>3+</sup> Zn plated
焊针 Pin header	黄铜,镀锡 Brass,Tin plated	黄铜,镀锡 Brass,Tin plated	黄铜,镀锡 Brass,Tin plated
方盒 Cage	黄铜,镀镍 Brass,Ni plated	黄铜,镀镍 Brass,Ni plated	黄铜,镀镍 Brass,Ni plated
电气性能 ELECTRICAL	UL IEC	UL IEC	UL IEC
额定电压 Rated voltage	300V 250V	300V 250V	300V 250V
额定电流 Rated current	12A 15A	12A 15A	15A 18A
使用线径 Wire range	26~14AWG 0.2~1.5mm <sup>2</sup>	26~14AWG 0.5~1.5mm <sup>2</sup>	24~12AWG 2.5mm <sup>2</sup>

产品型号 MODEL	GT129-5.0 GT129-5.08	GT129R-5.0 GT129R-5.08	GT129-7.5 GT129-7.62
产品照片 Photo	 Pole:2P3P-24P Pitch:5.0/5.08mm	 Pole:2P3P-24P Pitch:5.0/5.08mm	 Pole:2P3P-24P Pitch:7.5/7.62mm
产品图纸 Plan	 N=Number of contacts	 N=Number of contacts	 N=Number of contacts
材质/电镀 MATERIAL	塑件 Housing PA66,UL94V-0	塑件 Housing PA66,UL94V-0	塑件 Housing PA66,UL94V-0
螺丝 Screws	M3,钢,镀Cr <sup>3+</sup> 钝化彩锌 M3,steel,Cr <sup>3+</sup> Zn plated	M3,钢,镀Cr <sup>3+</sup> 钝化彩锌 M3,steel,Cr <sup>3+</sup> Zn plated	M3,钢,镀Cr <sup>3+</sup> 钝化彩锌 M3,steel,Cr <sup>3+</sup> Zn plated
焊针 Pin header	黄铜,镀锡 Brass,Tin plated	黄铜,镀锡 Brass,Tin plated	黄铜,镀锡 Brass,Tin plated
方盒 Cage	黄铜,镀镍 Brass,Ni plated	黄铜,镀镍 Brass,Ni plated	黄铜,镀镍 Brass,Ni plated
电气性能 ELECTRICAL	UL IEC	UL IEC	UL IEC
额定电压 Rated voltage	300V 250V	300V 250V	300V 450V
额定电流 Rated current	20A 20A	20A 20A	20A 20A
使用线径 Wire range	26~12AWG 0.5~2.5mm <sup>2</sup>	26~12AWG 0.5~2.5mm <sup>2</sup>	26~12AWG 0.5~2.5mm <sup>2</sup>

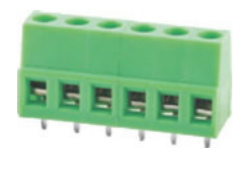

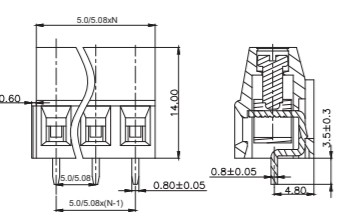
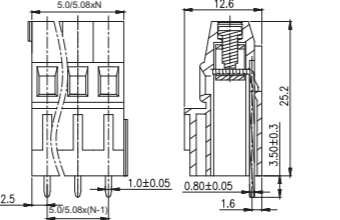
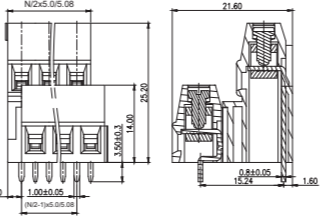
产品型号 MODEL	GT129R-7.5 GT129R-7.62	GT130-5.0 GT130-5.08	GT130-7.5 GT130-7.62
产品照片 Photo	 Pole:2P3P-24P Pitch:7.5/7.62mm	 Pole:2P3P-24P Pitch:5.0/5.08mm	 Pole:2P3P-24P Pitch:7.5/7.62mm
产品图纸 Plan	 N=Number of contacts	 N=Number of contacts	 N=Number of contacts
材质/电镀 MATERIAL	塑件 Housing PA66,UL94V-0	塑件 Housing PA66,UL94V-0	塑件 Housing PA66,UL94V-0
螺丝 Screws	M3,钢,镀Cr <sup>3+</sup> 钝化彩锌 M3,steel,Cr <sup>3+</sup> Zn plated	M3,钢,镀Cr <sup>3+</sup> 钝化彩锌 M3,steel,Cr <sup>3+</sup> Zn plated	M3,钢,镀Cr <sup>3+</sup> 钝化彩锌 M3,steel,Cr <sup>3+</sup> Zn plated
焊针 Pin header	黄铜,镀锡 Brass,Tin plated	黄铜,镀锡 Brass,Tin plated	黄铜,镀锡 Brass,Tin plated
方盒 Cage	黄铜,镀镍 Brass,Ni plated	黄铜,镀镍 Brass,Ni plated	黄铜,镀镍 Brass,Ni plated
电气性能 ELECTRICAL	UL IEC	UL IEC	UL IEC
额定电压 Rated voltage	300V 450V	300V 250V	300V 450V
额定电流 Rated current	20A 20A	12A 20A	12A 20A
使用线径 Wire range	26~12AWG 0.5~2.5mm <sup>2</sup>	26~12AWG 0.5~2.5mm <sup>2</sup>	26~12AWG 0.5~2.5mm <sup>2</sup>

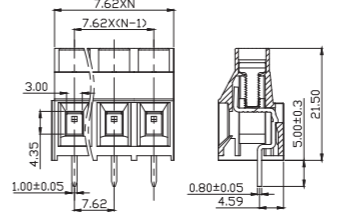
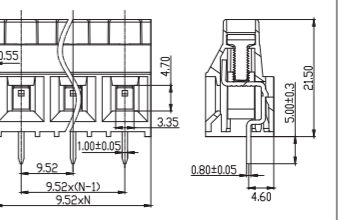
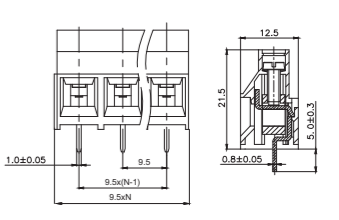

产品型号 MODEL	GT500B-5.0 GT500B-5.08	GT635-6.35	GT636-6.35
产品照片 Photo	 Pole:2*(2P3P-24P) Pitch:5.0/5.08mm	 Pole:2P3P-24P Pitch:6.35mm	 Pole:2P3P-24P Pitch:6.35mm
产品图纸 Plan	 N=Number of contacts	 N=Number of contacts	 N=Number of contacts
材质/电镀 MATERIAL	塑件 Housing PA66,UL94V-0	塑件 Housing PA66,UL94V-0	塑件 Housing PA66,UL94V-0
螺丝 Screws	M2.5,钢,镀Cr <sup>3+</sup> 钝化彩锌 M2.5,steel,Cr <sup>3+</sup> Zn plated	M3,钢,镀Cr <sup>3+</sup> 钝化彩锌 M3,steel,Cr <sup>3+</sup> Zn plated	M3,钢,镀Cr <sup>3+</sup> 钝化彩锌 M3,steel,Cr <sup>3+</sup> Zn plated
焊针 Pin header	黄铜,镀锡 Brass,Tin plated	黄铜,镀锡 Brass,Tin plated	黄铜,镀锡 Brass,Tin plated
方盒 Cage	黄铜,镀镍 Brass,Ni plated	黄铜,镀镍 Brass,Ni plated	黄铜,镀镍 Brass,Ni plated
电气性能 ELECTRICAL	UL IEC	UL IEC	UL IEC
额定电压 Rated voltage	300V 250V	300V 450V	300V 450V
额定电流 Rated current	15A 24A	30A 32A	30A 24A
使用线径 Wire range	24~12AWG 2.5mm <sup>2</sup>	26~10AWG 4.0mm <sup>2</sup>	26~10AWG 0.2~4.0mm <sup>2</sup>

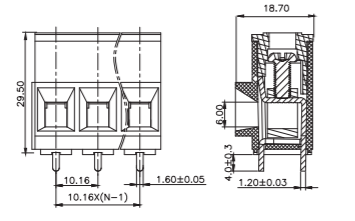
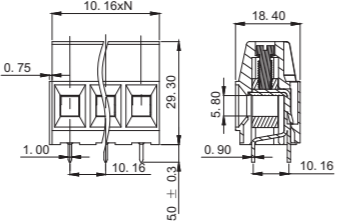
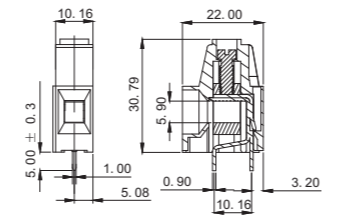

产品型号 MODEL	GT500-5.0 GT500-5.08	GT500H-5.0 GT500H-5.08	GT500A-5.0 GT500A-5.08
产品照片 Photo	 Pole:2P3P-24P Pitch:5.0/5.08mm	 Pole:2P3P-24P Pitch:5.0/5.08mm	 Pole:2*(2P3P-24P) Pitch:5.0/5.08mm
产品图纸 Plan	 N=Number of contacts	 N=Number of contacts	 N=Number of contacts
材质/电镀 MATERIAL	塑件 Housing PA66,UL94V-0	塑件 Housing PA66,UL94V-0	塑件 Housing PA66,UL94V-0
螺丝 Screws	M2.5,钢,镀Cr <sup>3+</sup> 钝化彩锌 M2.5,steel,Cr <sup>3+</sup> Zn plated	M2.5,钢,镀Cr <sup>3+</sup> 钝化彩锌 M2.5,steel,Cr <sup>3+</sup> Zn plated	M2.5,钢,镀Cr <sup>3+</sup> 钝化彩锌 M2.5,steel,Cr <sup>3+</sup> Zn plated
焊针 Pin header	黄铜,镀锡 Brass,Tin plated	黄铜,镀锡 Brass,Tin plated	黄铜,镀锡 Brass,Tin plated
方盒 Cage	黄铜,镀镍 Brass,Ni plated	黄铜,镀镍 Brass,Ni plated	黄铜,镀镍 Brass,Ni plated
电气性能 ELECTRICAL	UL IEC	UL IEC	UL IEC
额定电压 Rated voltage	300V 250V	300V 250V	300V 250V
额定电流 Rated current	15A 18A	20A 24A	15A 24A
使用线径 Wire range	24~12AWG 2.5mm <sup>2</sup>	28~12AWG 2.5mm <sup>2</sup>	24~12AWG 2.5mm <sup>2</sup>

产品型号 MODEL	GT636-7.62	GT636-9.52	GT950-9.5
产品照片 Photo	 Pole:2P3P-24P Pitch:7.62mm	 Pole:2P3P-24P Pitch:9.52mm	 Pole:2P3P-24P Pitch:9.5mm
产品图纸 Plan	 N=Number of contacts	 N=Number of contacts	 N=Number of contacts
材质/电镀 MATERIAL	塑件 Housing PA66,UL94V-0	塑件 Housing PA66,UL94V-0	塑件 Housing PA66,UL94V-0
螺丝 Screws	M3,钢,镀Cr <sup>3+</sup> 钝化彩锌 M3,steel,Cr <sup>3+</sup> Zn plated	M3,钢,镀Cr <sup>3+</sup> 钝化彩锌 M3,steel,Cr <sup>3+</sup> Zn plated	M3,钢,镀Cr <sup>3+</sup> 钝化彩锌 M3,steel,Cr <sup>3+</sup> Zn plated
焊针 Pin header	黄铜,镀锡 Brass,Tin plated	黄铜,镀锡 Brass,Tin plated	黄铜,镀锡 Brass,Tin plated
方盒 Cage	黄铜,镀镍 Brass,Ni plated	黄铜,镀镍 Brass,Ni plated	黄铜,镀镍 Brass,Ni plated
电气性能 ELECTRICAL	UL IEC	UL IEC	UL IEC
额定电压 Rated voltage	300V 630V	300V 1000V	300V 750V
额定电流 Rated current	30A 32A	30A 32A	30A 26A
使用线径 Wire range	26~10AWG 4.0mm <sup>2</sup>	26~10AWG 4.0mm <sup>2</sup>	26~10AWG 4.0mm <sup>2</sup>



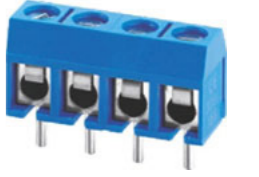
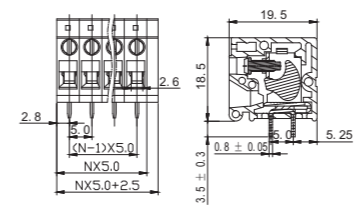
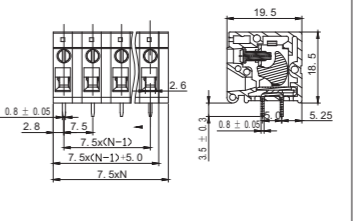
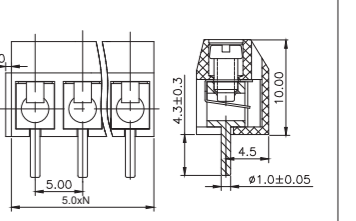



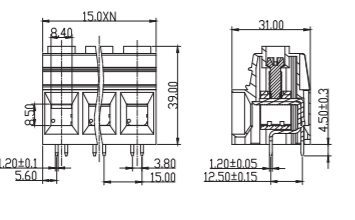
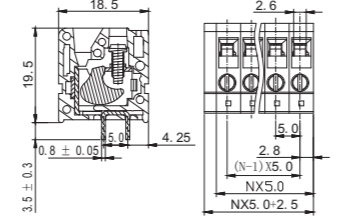
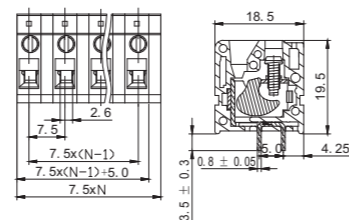

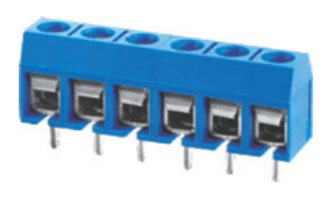
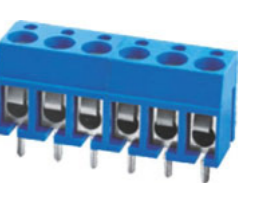
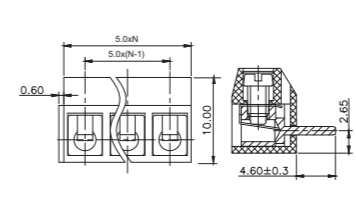
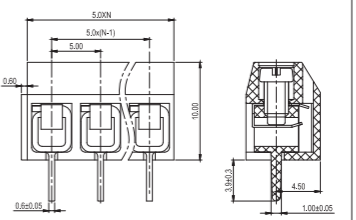
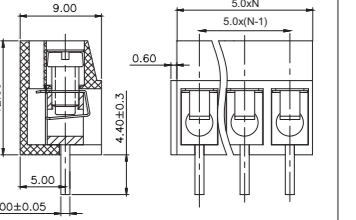
产品型号 MODEL	GT135T-10.16	GT136T-10.16	GT136HT-10.16
产品照片 Photo	 Pole:2P3P-24P Pitch:10.16mm	 Pole:2P3P-24P Pitch:10.16mm	 Pole:2P3P-24P Pitch:10.16mm
产品图纸 Plan	 N=Number of contacts	 N=Number of contacts	 N=Number of contacts
材质/电镀 MATERIAL	塑件 Housing PA66,UL94V-0	塑件 Housing PA66,UL94V-0	塑件 Housing PA66,UL94V-0
螺丝 Screws	M4,钢,镀Cr <sup>3+</sup> 钝化彩锌 M4,steel,Cr <sup>3+</sup> Zn plated	M4,钢,镀Cr <sup>3+</sup> 钝化彩锌 M4,steel,Cr <sup>3+</sup> Zn plated	M4,钢,镀Cr <sup>3+</sup> 钝化彩锌 M4,steel,Cr <sup>3+</sup> Zn plated
焊针 Pin header	黄铜,镀锡 Brass,Tin plated	黄铜,镀锡 Brass,Tin plated	黄铜,镀锡 Brass,Tin plated
方盒 Cage	黄铜,镀镍 Brass,Ni plated	黄铜,镀镍 Brass,Ni plated	黄铜,镀镍 Brass,Ni plated
电气性能 ELECTRICAL	UL IEC	UL IEC	UL IEC
额定电压 Rated voltage	300V 750V	300V 1000V	300V 1000V
额定电流 Rated current	52A 57A	60A 65A	60A 65A
使用线径 Wire range	20~6AWG 10.0mm <sup>2</sup>	20~6AWG 2.5~16.0mm <sup>2</sup>	20~6AWG 2.5~16.0mm <sup>2</sup>

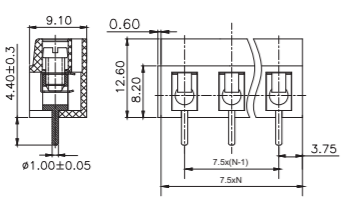
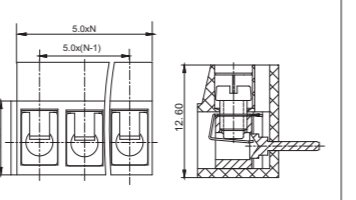
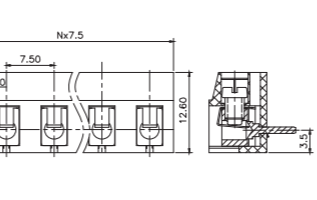

产品型号 MODEL	GT105R-5.0	GT105R-7.5	GT301-5.0
产品照片 Photo	 Pole:1-XXP Pitch:5.0mm	 Pole:1-XXP Pitch:7.5mm	 Pole:2P3P-24P Pitch:5.0mm
产品图纸 Plan	 N=Number of contacts	 N=Number of contacts	 N=Number of contacts
材质/电镀 MATERIAL	塑件 Housing PA66,UL94V-0	塑件 Housing PA66,UL94V-0	塑件 Housing PBT,UL94V-0
螺丝 Screws	M2.5,钢,镀Cr <sup>3+</sup> 钝化彩锌 M2.5,steel,Cr <sup>3+</sup> Zn plated	M2.5,钢,镀Cr <sup>3+</sup> 钝化彩锌 M2.5,steel,Cr <sup>3+</sup> Zn plated	M2.5,钢,镀Cr <sup>3+</sup> 钝化彩锌 M2.5,steel,Cr <sup>3+</sup> Zn plated
焊针 Pin header	紫铜,镀锡 Copper,Tin plated	紫铜,镀锡 Copper,Tin plated	黄铜,镀锡 Brass,Tin plated
方盒 Cage	钢,镀Cr <sup>3+</sup> 钝化彩锌 Steel,Cr <sup>3+</sup> Zn plated	钢,镀Cr <sup>3+</sup> 钝化彩锌 Steel,Cr <sup>3+</sup> Zn plated	不锈钢 Stainless steel
电气性能 ELECTRICAL	UL IEC	UL IEC	UL IEC
额定电压 Rated voltage	300V 250V	300V 450V	300V 250V
额定电流 Rated current	12A 24A	12A 24A	15A 17.5A
使用线径 Wire range	30~12AWG 0.5~2.5mm <sup>2</sup>	30~12AWG 0.5~2.5mm <sup>2</sup>	22~14AWG 1.5mm <sup>2</sup>

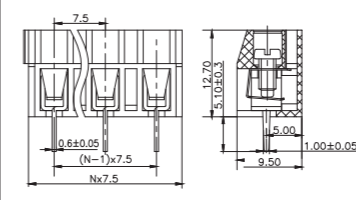
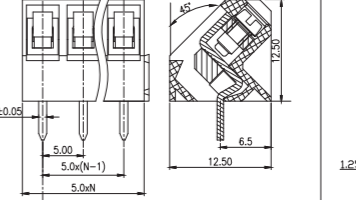
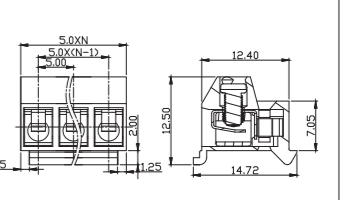

产品型号 MODEL	GT137T-15.0	GT105V-5.0	GT105V-7.5
产品照片 Photo	 Pole:2P3P-9P Pitch:15.0mm	 Pole:1-XXP Pitch:5.0mm	 Pole:1-XXP Pitch:7.5mm
产品图纸 Plan	 N=Number of contacts	 N=Number of contacts	 N=Number of contacts
材质/电镀 MATERIAL	塑件 Housing PA66,UL94V-0	塑件 Housing PA66,UL94V-0	塑件 Housing PA66,UL94V-0
螺丝 Screws	M5,钢,镀Cr <sup>3+</sup> 钝化彩锌 M5,steel,Cr <sup>3+</sup> Zn plated	M2.5,钢,镀Cr <sup>3+</sup> 钝化彩锌 M2.5,steel,Cr <sup>3+</sup> Zn plated	M2.5,钢,镀Cr <sup>3+</sup> 钝化彩锌 M2.5,steel,Cr <sup>3+</sup> Zn plated
焊针 Pin header	黄铜,镀锡 Brass,Tin plated	紫铜,镀锡 Copper,Tin plated	紫铜,镀锡 Copper,Tin plated
方盒 Cage	钢,镀Cr <sup>3+</sup> 钝化彩锌 Steel,Cr <sup>3+</sup> Zn plated	钢,镀Cr <sup>3+</sup> 钝化彩锌 Steel,Cr <sup>3+</sup> Zn plated	钢,镀Cr <sup>3+</sup> 钝化彩锌 Steel,Cr <sup>3+</sup> Zn plated
电气性能 ELECTRICAL	UL IEC	UL IEC	UL IEC
额定电压 Rated voltage	600V 1000V	300V 250V	300V 450V
额定电流 Rated current	115A 115A	12A 24A	12A 24A
使用线径 Wire range	20~2AWG 4.0~35.0mm <sup>2</sup>	30~12AWG 0.5~2.5mm <sup>2</sup>	30~12AWG 0.5~2.5mm <sup>2</sup>

产品型号 MODEL	GT301R-5.0	GT306-5.0	GT300-5.0
产品照片 Photo	 Pole:2P3P-24P Pitch:5.0mm	 Pole:2P3P-24P Pitch:5.0mm	 Pole:2P3P-24P Pitch:5.0mm
产品图纸 Plan	 N=Number of contacts	 N=Number of contacts	 N=Number of contacts
材质/电镀 MATERIAL	塑件 Housing PBT,UL94V-0	塑件 Housing PBT,UL94V-0	塑件 Housing PBT,UL94V-0
螺丝 Screws	M2.5,钢,镀Cr <sup>3+</sup> 钝化彩锌 M2.5,steel,Cr <sup>3+</sup> Zn plated	M2.5,钢,镀Cr <sup>3+</sup> 钝化彩锌 M2.5,steel,Cr <sup>3+</sup> Zn plated	M3,钢,镀Cr <sup>3+</sup> 钝化彩锌 M3,steel,Cr <sup>3+</sup> Zn plated
焊针 Pin header	黄铜,镀锡 Brass,Tin plated	黄铜,镀锡 Brass,Tin plated	黄铜,镀锡 Brass,Tin plated
簧片 Wire guard	不锈钢 Stainless steel	不锈钢 Stainless steel	不锈钢 Stainless steel
电气性能 ELECTRICAL	UL IEC	UL IEC	UL IEC
额定电压 Rated voltage	300V 250V	300V 250V	300V 250V
额定电流 Rated current	15A 17.5A	10A 15A	10A 24A
使用线径 Wire range	24~14AWG 1.5mm <sup>2</sup>	22~14AWG 1.5mm <sup>2</sup>	22~14AWG 2.5mm <sup>2</sup>

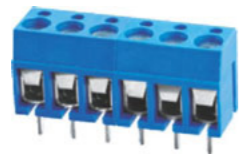
产品型号 MODEL	GT300-7.5		GT300R-5.0		GT300R-7.5	
产品照片 Photo						
产品图纸 Plan						
材质/电镀 MATERIAL	PBT,UL94V-0		PBT,UL94V-0		PBT,UL94V-0	
塑件 Housing	PBT,UL94V-0		PBT,UL94V-0		PBT,UL94V-0	
螺丝 Screws	M3,钢,镀Cr <sup>3+</sup> 钝化彩锌		M3,钢,镀Cr <sup>3+</sup> 钝化彩锌		M3,钢,镀Cr <sup>3+</sup> 钝化彩锌	
焊针 Pin header	M3,钢,镀Cr <sup>3+</sup> 钝化彩锌		M3,钢,镀Cr <sup>3+</sup> 钝化彩锌		M3,钢,镀Cr <sup>3+</sup> 钝化彩锌	
黄片 Wire guard	黄铜,镀锡		黄铜,镀锡		黄铜,镀锡	
电气性能 ELECTRICAL	UL IEC		UL IEC		UL IEC	
额定电压 Rated voltage	300V 450V		300V 250V		300V 450V	
额定电流 Rated current	10A 24A		10A 24A		10A 24A	
使用线径 Wire range	22~14AWG 2.5mm <sup>2</sup>		22~14AWG 2.5mm <sup>2</sup>		22~14AWG 2.5mm <sup>2</sup>	

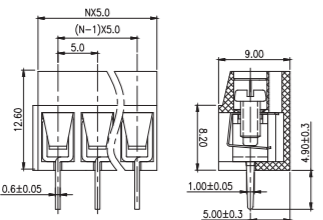
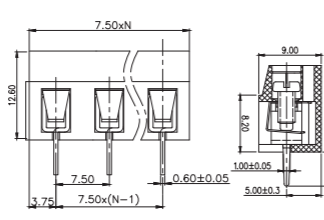
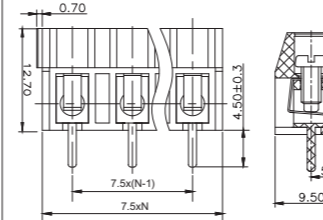
产品型号 MODEL	GT365-7.5		GT330-5.0		GT331-5.0	
产品照片 Photo						
产品图纸 Plan						
材质/电镀 MATERIAL	PBT,UL94V-0		PA66,UL94V-0		PA66,UL94V-0	
塑件 Housing	PBT,UL94V-0		PA66,UL94V-0		PA66,UL94V-0	
螺丝 Screws	M2.5,钢,镀Cr <sup>3+</sup> 钝化彩锌		M2.5,钢,镀Cr <sup>3+</sup> 钝化彩锌		M3,钢,镀Cr <sup>3+</sup> 钝化彩锌	
焊针 Pin header	M2.5,钢,镀Cr <sup>3+</sup> 钝化彩锌		M2.5,钢,镀Cr <sup>3+</sup> 钝化彩锌		M3,钢,镀Cr <sup>3+</sup> 钝化彩锌	
黄片 Wire guard	黄铜,镀锡		黄铜,镀锡		磷青铜	
电气性能 ELECTRICAL	UL IEC		UL IEC		UL IEC	
额定电压 Rated voltage	300V 450V		300V 250V		300V 250V	
额定电流 Rated current	15A 20A		15A 24A		10A 12A	
使用线径 Wire range	22~14AWG 2.5mm <sup>2</sup>		22~14AWG 2.5mm <sup>2</sup>		28~14AWG 2.5mm <sup>2</sup>	

产品型号 MODEL	GT305-5.0		GT305-7.5		GT360-7.5	
产品照片 Photo						
产品图纸 Plan						
材质/电镀 MATERIAL	PBT,UL94V-0		PBT,UL94V-0		PBT,UL94V-0	
塑件 Housing	PBT,UL94V-0		PBT,UL94V-0		PBT,UL94V-0	
螺丝 Screws	M2.5,钢,镀Cr <sup>3+</sup> 钝化彩锌		M2.5,钢,镀Cr <sup>3+</sup> 钝化彩锌		M3,钢,镀Cr <sup>3+</sup> 钝化彩锌	
焊针 Pin header	M2.5,钢,镀Cr <sup>3+</sup> 钝化彩锌		M2.5,钢,镀Cr <sup>3+</sup> 钝化彩锌		M3,钢,镀Cr <sup>3+</sup> 钝化彩锌	
黄片 Wire guard	黄铜,镀锡		黄铜,镀锡		黄铜,镀锡	
电气性能 ELECTRICAL	UL IEC		UL IEC		UL IEC	
额定电压 Rated voltage	300V 250V		300V 450V		300V 450V	
额定电流 Rated current	15A 20A		15A 20A		15A 24A	
使用线径 Wire range	22~14AWG 2.5mm <sup>2</sup>		22~14AWG 2.5mm <sup>2</sup>		22~14AWG 2.5mm <sup>2</sup>	

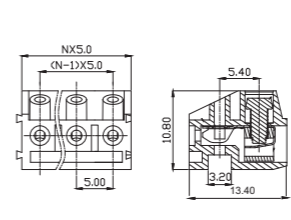
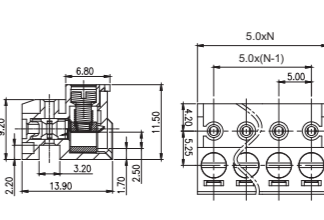
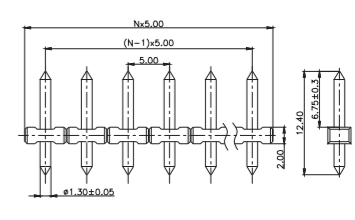
产品型号 MODEL	GT332K-5.0		GT332W-5.0		GT332J-5.0	
产品照片 Photo						
产品图纸 Plan						
材质/电镀 MATERIAL	PBT,UL94V-0		PA66,UL94V-0		PA66+10%GF,UL94V-0	
塑件 Housing	PBT,UL94V-0		PA66,UL94V-0		PA66+10%GF,UL94V-0	
螺丝 Screws	M2.5,钢,镀Cr <sup>3+</sup> 钝化彩锌		M2.5,钢,镀Cr <sup>3+</sup> 钝化彩锌		M2.5,钢,镀Cr <sup>3+</sup> 钝化彩锌	
焊针 Pin header	M2.5,钢,镀Cr <sup>3+</sup> 钝化彩锌		M2.5,钢,镀Cr <sup>3+</sup> 钝化彩锌		M2.5,钢,镀Cr <sup>3+</sup> 钝化彩锌	
黄片 Wire guard	黄铜,镀锡		黄铜,镀锡		磷青铜	
电气性能 ELECTRICAL	UL IEC		UL IEC		UL IEC	
额定电压 Rated voltage	300V 250V		300V 250V		300V 250V	
额定电流 Rated current	10A 12A		10A 12A		10A 12A	
使用线径 Wire range	28~16AWG 1.5mm <sup>2</sup>		30~16AWG 1.5mm <sup>2</sup>		-	



产品型号 MODEL	GT332JR-5.0	GT333K-3.5 GT333K-3.81	GT333J-3.5 GT333J-3.81
产品照片 Photo	 Pole:2P3P-24P Pitch:5.0mm	 Pole:2P3P-24P Pitch:3.5/3.81mm	 Pole:2P3P-24P Pitch:3.5/3.81mm
产品图纸 Plan	 N=Number of contacts	 N=Number of contacts	 N=Number of contacts
材质/电镀 MATERIAL	塑件 Housing PA66+25%GF,UL94V-0 螺丝 Screws - 焊针 Pin header 黄铜,镀锡 Brass,Tin plated 簧片 Wire guard -	PBT,UL94V-0 M2,钢,镀Cr <sup>3+</sup> 钝化彩锌 M2,steel,Cr <sup>3+</sup> Zn plated 黄铜,镀锡 Brass,Tin plated 磷青铜 Phosphor bronze 黄铜,镀镍 Brass,Ni plated	PA66+25%GF,UL94V-0 黄铜,镀锡 Brass,Tin plated
电气性能 ELECTRICAL	UL IEC	UL IEC	UL IEC
额定电压 Rated voltage	300V 250V	300V 250V	300V 250V
额定电流 Rated current	10A 12A	8A 8A	8A 8A
使用线径 Wire range	-	28~16AWG 1.0mm <sup>2</sup>	-

产品型号 MODEL	GT340-3.81	GT340R-3.81	GT302-5.0
产品照片 Photo	 Pole:2P3P-24P Pitch:3.81mm	 Pole:2P3P-24P Pitch:3.81mm	 Pole:2P3P-24P Pitch:5.0mm
产品图纸 Plan	 N=Number of contacts	 N=Number of contacts	 N=Number of contacts
材质/电镀 MATERIAL	塑件 Housing PA66,UL94V-0 螺丝 Screws M2,钢,镀Cr <sup>3+</sup> 钝化彩锌 M2,steel,Cr <sup>3+</sup> Zn plated 焊针 Pin header 黄铜,镀锡 Brass,Tin plated 簧片 Wire guard 磷青铜 Phosphor bronze	PA66,UL94V-0 M2,钢,镀Cr <sup>3+</sup> 钝化彩锌 M2,steel,Cr <sup>3+</sup> Zn plated 黄铜,镀锡 Brass,Tin plated 磷青铜 Phosphor bronze	PA66,UL94V-0 M2.5,钢,镀Cr <sup>3+</sup> 钝化彩锌 M2.5,steel,Cr <sup>3+</sup> Zn plated 黄铜,镀锡 Brass,Tin plated 磷青铜 Phosphor bronze 不锈钢 Stainless steel
电气性能 ELECTRICAL	UL IEC	UL IEC	UL IEC
额定电压 Rated voltage	300V 130V	300V 130V	300V 250V
额定电流 Rated current	7A 10A	7A 10A	20A 25A
使用线径 Wire range	24~18AWG 1.0mm <sup>2</sup>	24~18AWG 1.0mm <sup>2</sup>	20~12AWG 0.5~4.0mm <sup>2</sup>

产品型号 MODEL	GT333JR-3.5	GT350-3.5 GT350-3.96	GT350R-3.5 GT350R-3.96
产品照片 Photo	 Pole:2P3P-24P Pitch:3.5mm	 Pole:2P3P-24P Pitch:3.5/3.96mm	 Pole:2P3P-24P Pitch:3.5/3.96mm
产品图纸 Plan	 N=Number of contacts	 N=Number of contacts	 N=Number of contacts
材质/电镀 MATERIAL	塑件 Housing PA66+25%GF,UL94V-0 螺丝 Screws - 焊针 Pin header 黄铜,镀锡 Brass,Tin plated 簧片 Wire guard -	PA66,UL94V-0 M2,钢,镀Cr <sup>3+</sup> 钝化彩锌 M2,steel,Cr <sup>3+</sup> Zn plated 黄铜,镀锡 Brass,Tin plated 磷青铜 Phosphor bronze	PA66,UL94V-0 M2,钢,镀Cr <sup>3+</sup> 钝化彩锌 M2,steel,Cr <sup>3+</sup> Zn plated 黄铜,镀锡 Brass,Tin plated 磷青铜 Phosphor bronze
电气性能 ELECTRICAL	UL IEC	UL IEC	UL IEC
额定电压 Rated voltage	300V 250V	300V 130V	300V 130V
额定电流 Rated current	8A 8A	7A 10A	7A 10A
使用线径 Wire range	-	24~18AWG 1.0mm <sup>2</sup>	24~18AWG 1.0mm <sup>2</sup>

产品型号 MODEL	GT126-5.0	GT126-7.5	GT126R-5.0
产品照片 Photo	 Pole:2P3P-24P Pitch:5.0mm	 Pole:2P3P-24P Pitch:7.5mm	 Pole:2P3P-24P Pitch:5.0mm
产品图纸 Plan	 N=Number of contacts	 N=Number of contacts	 N=Number of contacts
材质/电镀 MATERIAL	塑件 Housing PA66,UL94V-0 螺丝 Screws M2.5,钢,镀Cr <sup>3+</sup> 钝化彩锌 M2.5,steel,Cr <sup>3+</sup> Zn plated 焊针 Pin header 黄铜,镀锡 Brass,Tin plated 簧片 Wire guard 不锈钢 Stainless steel	PA66,UL94V-0 M2.5,钢,镀Cr <sup>3+</sup> 钝化彩锌 M2.5,steel,Cr <sup>3+</sup> Zn plated 黄铜,镀锡 Brass,Tin plated 磷青铜 Phosphor bronze 不锈钢 Stainless steel	PA66,UL94V-0 M2.5,钢,镀Cr <sup>3+</sup> 钝化彩锌 M2.5,steel,Cr <sup>3+</sup> Zn plated 黄铜,镀锡 Brass,Tin plated 磷青铜 Phosphor bronze 不锈钢 Stainless steel
电气性能 ELECTRICAL	UL IEC	UL IEC	UL IEC
额定电压 Rated voltage	300V 250V	300V 450V	300V 250V
额定电流 Rated current	10A 18A	10A 18A	10A 18A
使用线径 Wire range	26~14AWG 0.5~2.5mm <sup>2</sup>	26~14AWG 0.5~2.5mm <sup>2</sup>	26~14AWG 0.5~2.5mm <sup>2</sup>

产品型号 MODEL	GT166-5.0		GT167-5.0		GT167R-5.0	
产品照片 Photo						
产品图纸 Plan						
材质/电镀 MATERIAL	PA66,UL94V-0		PA66,UL94V-0		PA66,UL94V-0	
塑件 Housing	PA66,UL94V-0		PA66,UL94V-0		PA66,UL94V-0	
螺丝 Screws	M3,钢,镀Cr <sup>3+</sup> 钝化彩锌	M3,steel,Cr <sup>3+</sup> Zn plated	M2.5,钢,镀Cr <sup>3+</sup> 钝化彩锌	M2.5,steel,Cr <sup>3+</sup> Zn plated	M2.5,钢,镀Cr <sup>3+</sup> 钝化彩锌	M2.5,steel,Cr <sup>3+</sup> Zn plated
焊针 Pin header	黄铜,镀锡	Brass,Tin plated	黄铜,镀锡	Brass,Tin plated	黄铜,镀锡	Brass,Tin plated
簧片 Wire guard	不锈钢	Stainless steel	磷青铜	Phosphor bronze	磷青铜	Phosphor bronze
电气性能 ELECTRICAL	UL	IEC	UL	IEC	UL	IEC
额定电压 Rated voltage	300V	250V	300V	250V	300V	250V
额定电流 Rated current	15A	22A	15A	22A	15A	22A
使用线径 Wire range	22~12AWG	2.5mm <sup>2</sup>	22~12AWG	0.5~2.5mm <sup>2</sup>	22~12AWG	0.5~2.5mm <sup>2</sup>

产品型号 MODEL	GT166-5.0		GT167-5.0		GT167R-5.0	
产品照片 Photo						
产品图纸 Plan						
材质/电镀 MATERIAL	PA66,UL94V-0		PA66,UL94V-0		PA66,UL94V-0	
塑件 Housing	PA66,UL94V-0		PA66,UL94V-0		PA66,UL94V-0	
螺丝 Screws	M3,钢,镀Cr <sup>3+</sup> 钝化彩锌	M3,steel,Cr <sup>3+</sup> Zn plated	M2.5,钢,镀Cr <sup>3+</sup> 钝化彩锌	M2.5,steel,Cr <sup>3+</sup> Zn plated	M2.5,钢,镀Cr <sup>3+</sup> 钝化彩锌	M2.5,steel,Cr <sup>3+</sup> Zn plated
焊针 Pin header	黄铜,镀锡	Brass,Tin plated	黄铜,镀锡	Brass,Tin plated	黄铜,镀锡	Brass,Tin plated
簧片 Wire guard	不锈钢	Stainless steel	磷青铜	Phosphor bronze	磷青铜	Phosphor bronze
电气性能 ELECTRICAL	UL	IEC	UL	IEC	UL	IEC
额定电压 Rated voltage	300V	250V	300V	250V	300V	250V
额定电流 Rated current	15A	22A	15A	22A	15A	22A
使用线径 Wire range	22~12AWG	2.5mm <sup>2</sup>	22~12AWG	0.5~2.5mm <sup>2</sup>	22~12AWG	0.5~2.5mm <sup>2</sup>







## PCB弹簧式接线端子 PCB Spring Terminal Blocks

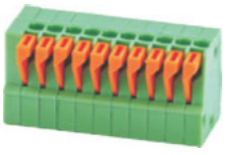
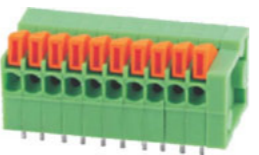
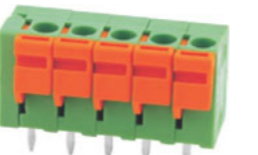
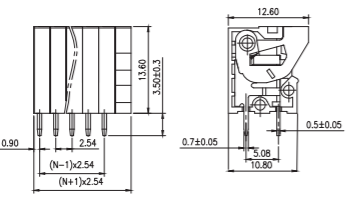
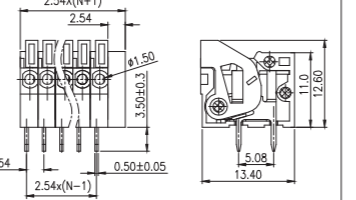
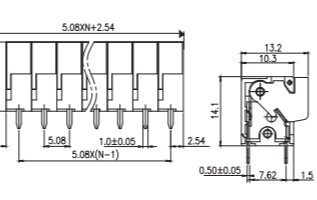

PCB弹簧式接线端子有2.5mm、2.54mm、3.5mm、5.0mm、7.5mm、7.62mm、10.0mm等间距，圆棒端子及单芯线能直接插入，不需要手把辅助，但较小的电线可用手把打开夹子将电线夹紧。大部分免螺丝式端子台都是一片一片组合而成。产品设计符合IEC60998、UL1059等国际标准，大部分产品通过UL等认证。

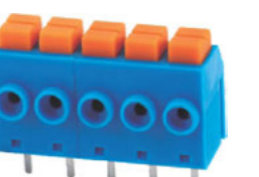

PCB spring terminal blocks with different pitches from 2.5mm to 10.00mm, using highly reliable elastic material that is resistant to shock, easy to match, and simple to assemble. The ferrule and single-strand wires can be inserted directly without handles, and smaller wires can be secured by using the handle to open the clips. Due to the direction and alignment of the wires, these blocks are suitable for use with small space, and can be combined in any numbers. The product is designed comply with international quality standards, such as IEC60998 and UL1059.

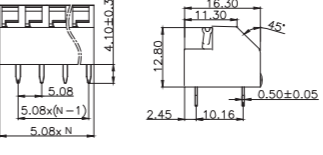
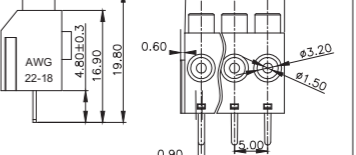
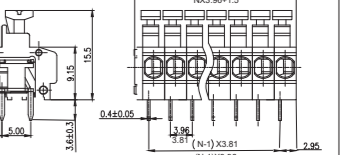

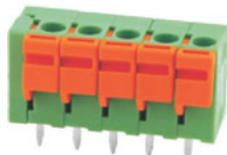
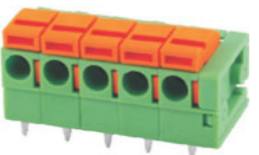

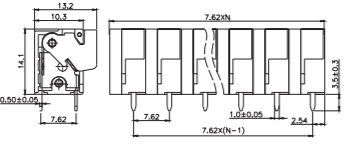
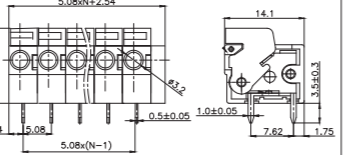
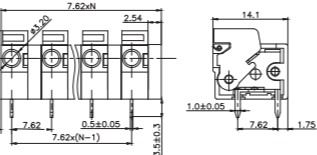

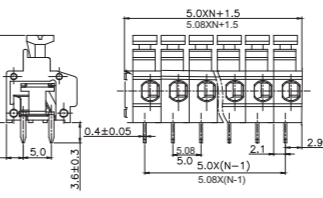
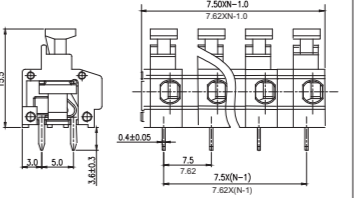
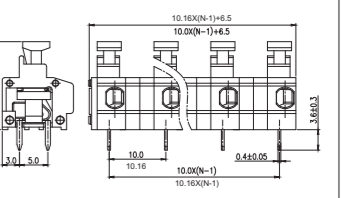

产品型号 MODEL	GT141V-2.54	GT141R-2.54	GT142V-5.08
产品照片 Photo			
产品图纸 Plan			
材质/电镀 MATERIAL	塑件 Housing PA66+5%GF,UL94V-0 焊脚 Pin header 黄铜,镀锡 Brass,Tin plated 弹片 Wire guard 不锈钢 Stainless steel 触点材料 Contact -	塑件 Housing PA66+5%GF,UL94V-0 焊脚 Pin header 黄铜,镀锡 Brass,Tin plated 弹片 Wire guard 不锈钢 Stainless steel 触点材料 Contact -	塑件 Housing PA66,UL94V-0 焊脚 Pin header 黄铜,镀锡 Brass,Tin plated 弹片 Wire guard 不锈钢 Stainless steel 触点材料 Contact -
电气性能 ELECTRICAL	UL IEC	UL IEC	UL IEC
额定电压 Rated voltage	150V 130V	150V 130V	300V 250V
额定电流 Rated current	2A 6A	2A 6A	10A 15A
使用线径 Wire range	24~20AWG 0.2~1.0mm <sup>2</sup>	24~20AWG 0.2~1.0mm <sup>2</sup>	22~16AWG 0.2~1.5mm <sup>2</sup>

产品型号 MODEL	GT237-5.08	GT390-5.0	GT235-3.81 GT235-3.96
产品照片 Photo			
产品图纸 Plan			
材质/电镀 MATERIAL	塑件 Housing PA66,UL94V-0 焊脚 Pin header 黄铜,镀锡 Brass,Tin plated 弹片 Wire guard 不锈钢 Stainless steel 触点材料 Contact -	塑件 Housing PBT,UL94V-0 焊脚 Pin header 黄铜,镀锡 Brass,Tin plated 弹片 Wire guard 不锈钢 Stainless steel 触点材料 Contact -	塑件 Housing PA66,UL94V-0 焊脚 Pin header 磷青铜,镀锡 Phosphor bronze,Tin plated 弹片 Wire guard 不锈钢 Stainless steel 触点材料 Contact -
电气性能 ELECTRICAL	UL IEC	UL IEC	UL IEC
额定电压 Rated voltage	300V 320V	300V 250V	300V 250V
额定电流 Rated current	10A 10A	8A 10A	5A 10A
使用线径 Wire range	22~16AWG 0.2~1.5mm <sup>2</sup>	22~18AWG 1.0mm <sup>2</sup>	20~18AWG 1.5mm <sup>2</sup>

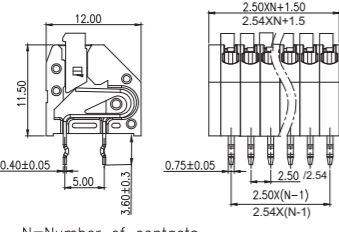
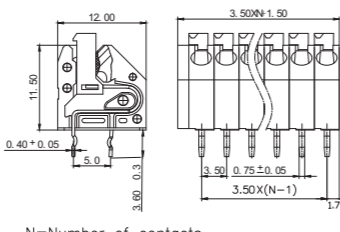
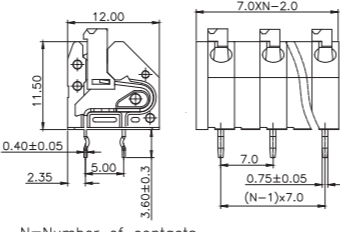

产品型号 MODEL	GT142V-7.62	GT142R-5.08	GT142R-7.62
产品照片 Photo			
产品图纸 Plan			
材质/电镀 MATERIAL	塑件 Housing PA66,UL94V-0 焊脚 Pin header 黄铜,镀锡 Brass,Tin plated 弹片 Wire guard 不锈钢 Stainless steel 触点材料 Contact -	塑件 Housing PA66,UL94V-0 焊脚 Pin header 黄铜,镀锡 Brass,Tin plated 弹片 Wire guard 不锈钢 Stainless steel 触点材料 Contact -	塑件 Housing PA66,UL94V-0 焊脚 Pin header 黄铜,镀锡 Brass,Tin plated 弹片 Wire guard 不锈钢 Stainless steel 触点材料 Contact -
电气性能 ELECTRICAL	UL IEC	UL IEC	UL IEC
额定电压 Rated voltage	300V 450V	300V 250V	300V 450V
额定电流 Rated current	10A 15A	10A 15A	10A 15A
使用线径 Wire range	22~16AWG 0.2~1.5mm <sup>2</sup>	22~16AWG 0.2~1.5mm <sup>2</sup>	22~16AWG 0.2~1.5mm <sup>2</sup>

产品型号 MODEL	GT235-5.0 GT235-5.08	GT235-7.5 GT235-7.62	GT235-10.0 GT235-10.16
产品照片 Photo			
产品图纸 Plan			
材质/电镀 MATERIAL	塑件 Housing PA66,UL94V-0 焊脚 Pin header 磷青铜,镀锡 Phosphor bronze,Tin plated 弹片 Wire guard 不锈钢 Stainless steel 触点材料 Contact -	塑件 Housing PA66,UL94V-0 焊脚 Pin header 磷青铜,镀锡 Phosphor bronze,Tin plated 弹片 Wire guard 不锈钢 Stainless steel 触点材料 Contact -	塑件 Housing PA66,UL94V-0 焊脚 Pin header 磷青铜,镀锡 Phosphor bronze,Tin plated 弹片 Wire guard 不锈钢 Stainless steel 触点材料 Contact -
电气性能 ELECTRICAL	UL IEC	UL IEC	UL IEC
额定电压 Rated voltage	300V 250V	300V 450V	300V 750V
额定电流 Rated current	5A 15A	5A 15A	5A 15A
使用线径 Wire range	20~18AWG 0.2~2.5mm <sup>2</sup> SOL 0.2~1.5mm <sup>2</sup> STR	20~18AWG 0.2~2.5mm <sup>2</sup> SOL 0.2~1.5mm <sup>2</sup> STR	20~18AWG 0.2~2.5mm <sup>2</sup> SOL 0.2~1.5mm <sup>2</sup> STR

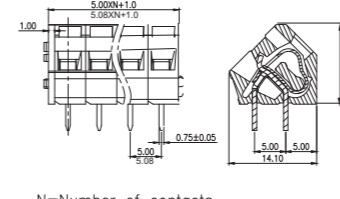
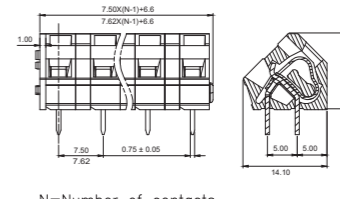
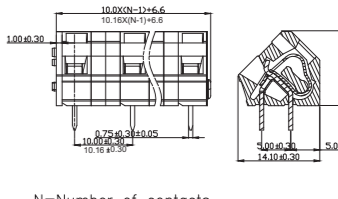
产品型号 MODEL	GT250-2.5 GT250-2.54	GT250-3.5	GT250-7.0
产品照片 Photo	 Pole:1-XXP Pitch:2.5/2.54mm	 Pole:1-XXP Pitch:3.5mm	 Pole:1-XXP Pitch:7.0mm
产品图纸 Plan	 N=Number of contacts	 N=Number of contacts	 N=Number of contacts
材质/电镀 MATERIAL	塑件 Housing PA66,UL94V-0	塑件 Housing PA66,UL94V-0	塑件 Housing PA66,UL94V-0
焊脚 Pin header	磷青铜,镀锡 Phosphor bronze,Tin plated	磷青铜,镀锡 Phosphor bronze,Tin plated	磷青铜,镀锡 Phosphor bronze,Tin plated
弹片 Wire guard	-	-	-
触点材料 Contact	-	-	-
电气性能 ELECTRICAL	UL IEC	UL IEC	UL IEC
额定电压 Rated voltage	300V 250V	300V 400V	300V 400V
额定电流 Rated current	2A 2A	7A 5A	7A 5A
使用线径 Wire range	24~20AWG 0.2~0.5mm <sup>2</sup>	22~18AWG 0.2~0.75mm <sup>2</sup>	22~18AWG 0.2~0.75mm <sup>2</sup>

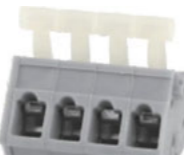
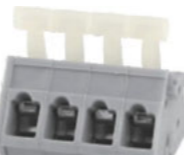
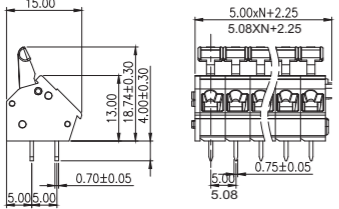
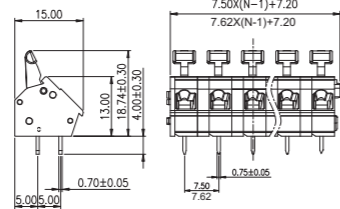
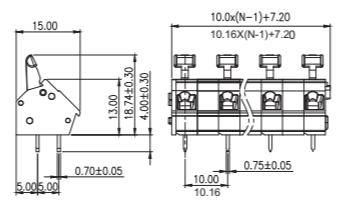
产品型号 MODEL	GT245-5.0 GT245-5.08	GT245-7.5 GT245-7.62	GT245-10.0 GT245-10.16
产品照片 Photo	 Pole:1-XXP Pitch:5.0/5.08mm	 Pole:1-XXP Pitch:7.5/7.62mm	 Pole:1-XXP Pitch:10.0/10.16mm
产品图纸 Plan	 N=Number of contacts	 N=Number of contacts	 N=Number of contacts
材质/电镀 MATERIAL	塑件 Housing PA66,UL94V-0	塑件 Housing PA66,UL94V-0	塑件 Housing PA66,UL94V-0
焊脚 Pin header	磷青铜,镀锡 Phosphor bronze,Tin plated	磷青铜,镀锡 Phosphor bronze,Tin plated	磷青铜,镀锡 Phosphor bronze,Tin plated
弹片 Wire guard	不锈钢 Stainless steel	不锈钢 Stainless steel	不锈钢 Stainless steel
触点材料 Contact	-	-	-
电气性能 ELECTRICAL	UL IEC	UL IEC	UL IEC
额定电压 Rated voltage	300V 450V	300V 750V	300V 1000V
额定电流 Rated current	15A 17A	15A 17A	15A 17A
使用线径 Wire range	28~12AWG 0.2~2.5mm <sup>2</sup>	28~12AWG 0.2~2.5mm <sup>2</sup>	28~12AWG 0.2~2.5mm <sup>2</sup>

产品型号 MODEL	GT243-5.0 GT243-5.08	GT243-7.5 GT243-7.62	GT243-10.0 GT243-10.16
产品照片 Photo	 Pole:1-XXP Pitch:5.0/5.08mm	 Pole:1-XXP Pitch:7.5/7.62mm	 Pole:1-XXP Pitch:10.0/10.16mm
产品图纸 Plan	 N=Number of contacts	 N=Number of contacts	 N=Number of contacts
材质/电镀 MATERIAL	塑件 Housing PA66,UL94V-0	塑件 Housing PA66,UL94V-0	塑件 Housing PA66,UL94V-0
焊脚 Pin header	磷青铜,镀锡 Phosphor bronze,Tin plated	磷青铜,镀锡 Phosphor bronze,Tin plated	磷青铜,镀锡 Phosphor bronze,Tin plated
弹片 Wire guard	不锈钢 Stainless steel	不锈钢 Stainless steel	不锈钢 Stainless steel
触点材料 Contact	-	-	-
电气性能 ELECTRICAL	UL IEC	UL IEC	UL IEC
额定电压 Rated voltage	300V 450V	300V 750V	300V 1000V
额定电流 Rated current	15A 17A	15A 17A	15A 17A
使用线径 Wire range	28~12AWG 0.2~2.5mm <sup>2</sup>	28~12AWG 0.2~2.5mm <sup>2</sup>	28~12AWG 0.2~2.5mm <sup>2</sup>

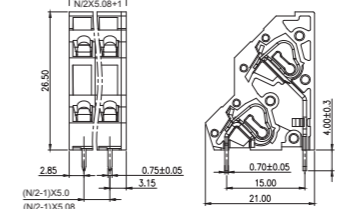
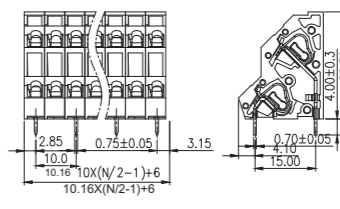
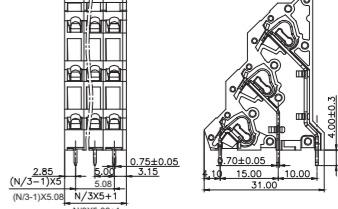
产品型号 MODEL	GT245H2-5.0 GT245H2-5.08	GT245H2-10.0 GT245H2-10.16	GT245H3-5.0 GT245H3-5.08
产品照片 Photo	 Pole:2*(1-XXP) Pitch:5.0/5.08mm	 Pole:2*(1-XXP) Pitch:10.0/10.16mm	 Pole:3*(1-XXP) Pitch:5.0/5.08mm
产品图纸 Plan	 N=Number of contacts	 N=Number of contacts	 N=Number of contacts
材质/电镀 MATERIAL	塑件 Housing PA66,UL94V-0	塑件 Housing PA66,UL94V-0	塑件 Housing PA66,UL94V-0
焊脚 Pin header	磷青铜,镀锡 Phosphor bronze,Tin plated	磷青铜,镀锡 Phosphor bronze,Tin plated	磷青铜,镀锡 Phosphor bronze,Tin plated
弹片 Wire guard	不锈钢 Stainless steel	不锈钢 Stainless steel	不锈钢 Stainless steel
触点材料 Contact	-	-	-
电气性能 ELECTRICAL	UL IEC	UL IEC	UL IEC
额定电压 Rated voltage	300V 450V	300V 1000V	300V 450V
额定电流 Rated current	10A 18A	10A 12A	10A 18A
使用线径 Wire range	28~12AWG 0.2~2.5mm <sup>2</sup>	28~12AWG 2.5mm <sup>2</sup>	28~12AWG 0.2~2.5mm <sup>2</sup>



产品型号 MODEL	GT245H4-5.0 GT245H4-5.08	GT228-3.5	GT222-8.0
产品照片 Photo			
产品图纸 Plan			
材质/电镀 MATERIAL	塑件 Housing PA66,UL94V-0 焊脚 Pin header 磷青铜,镀锡 Phosphor bronze,Tin plated 弹片 Wire guard 不锈钢 Stainless steel 触点材料 Contact -	PC,UL94V-2 不锈钢 Stainless steel 钢,镀镍 Steel,Ni plated	PA66,UL94V-0 不锈钢 Stainless steel 紫铜 Copper
电气性能 ELECTRICAL	UL IEC 额定电压 Rated voltage 300V 450V 额定电流 Rated current 10A 18A 使用线径 Wire range 28~12AWG 0.2~2.5mm <sup>2</sup>	UL IEC 600V 450V 20A 24A 22~12AWG 0.5~2.5mm <sup>2</sup>	UL IEC 300V 450V 22A 24A 22~12AWG 0.2~2.5mm <sup>2</sup>





产品型号 MODEL	GT224-8.0	GT238-10.0
产品照片 Photo		
产品图纸 Plan		
材质/电镀 MATERIAL	塑件 Housing PA66,UL94V-0 焊脚 Pin header - 弹片 Wire guard 不锈钢 Stainless steel 触点材料 Contact 紫铜 Copper	PA66,UL94V-0 不锈钢 Stainless steel 紫铜 Copper
电气性能 ELECTRICAL	UL IEC 额定电压 Rated voltage 300V 450V 额定电流 Rated current 22A 24A 使用线径 Wire range 22~12AWG 0.2~2.5mm <sup>2</sup>	UL IEC 600V 450V 20A 24A 22~12AWG 0.75~2.5mm <sup>2</sup>



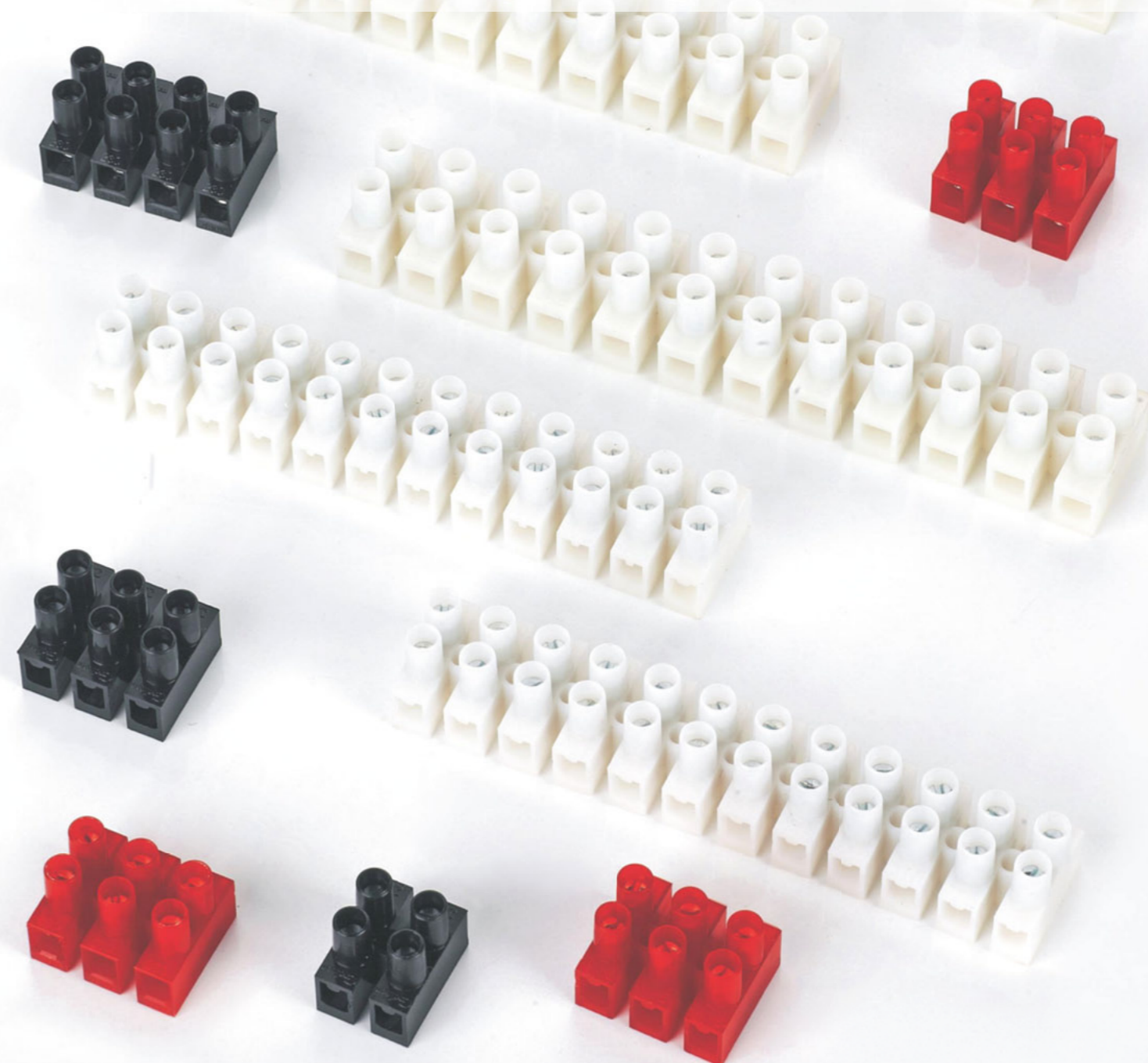

## 贯通式接线端子 Feed Through Terminal Blocks



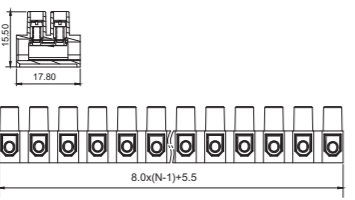
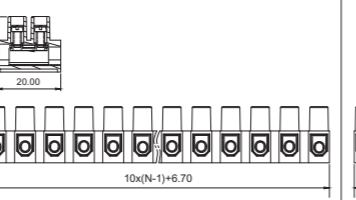



贯通式接线端子不带保险丝，它可将二导体方便、可靠连接起来。可以连接0.5mm<sup>2</sup>至35mm<sup>2</sup>的所有类型的导线。产品设计符合IEC60998、UL1059等国际标准并通过UL等认证。

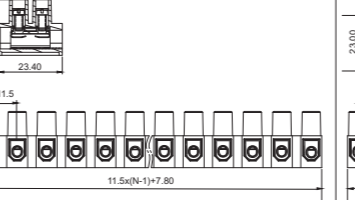
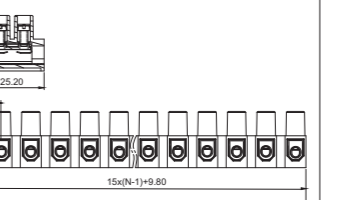

Feed through terminal blocks is available with different wire sizes from 0.5mm<sup>2</sup> to 35mm<sup>2</sup>. They could connect two conductors easily and stably. The product is designed comply with international quality standards, such as IEC60998 and UL1059.

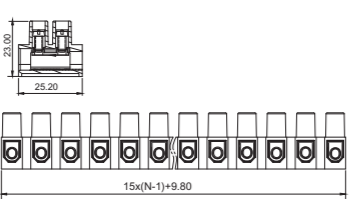
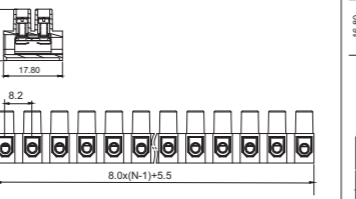
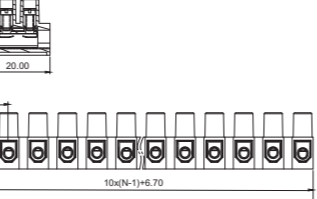

产品型号 MODEL	GT8HS	GT10HS	GT12HS
产品照片 Photo			
产品照片 Photo	Pole:2P-12P Pitch:8.0mm 	Pole:2P-12P Pitch:10.0mm 	Pole:2P-12P Pitch:12.0mm 
产品图纸 Plan			
材质/电镀 MATERIAL	塑料 Housing PA66,UL94V-2 载流体 Current carrier 锌合金,镀Cr3+钝化彩锌 Zn Alloy,Cr3+ Zn plated 螺丝 Screws 钢,镀Cr3+钝化彩锌 Steel,Cr3+ Zn plated 簧片 Wire guard -	塑料 Housing PA66,UL94V-2 载流体 Current carrier 锌合金,镀Cr3+钝化彩锌 Zn Alloy,Cr3+ Zn plated 螺丝 Screws 钢,镀Cr3+钝化彩锌 Steel,Cr3+ Zn plated 簧片 Wire guard -	塑料 Housing PA66,UL94V-2 载流体 Current carrier 锌合金,镀Cr3+钝化彩锌 Zn Alloy,Cr3+ Zn plated 螺丝 Screws 钢,镀Cr3+钝化彩锌 Steel,Cr3+ Zn plated 簧片 Wire guard -
电气性能 ELECTRICAL	UL IEC	UL IEC	UL IEC
额定电压 Rated voltage	300V 450V	300V 450V	600V 750V
额定电流 Rated current	20A 32A	30A 41A	30A 57A
使用线径 Wire range	20~12AWG 0.5~4.0mm <sup>2</sup>	18~10AWG 1.0~6.0mm <sup>2</sup>	14~10AWG 2.5~10.0mm <sup>2</sup>

产品型号 MODEL	GT12HWP	GT15HWP	
产品照片 Photo			
产品照片 Photo	Pole:2P-12P Pitch:12.0mm 	Pole:2P-12P Pitch:15.0mm 	
产品图纸 Plan			
材质/电镀 MATERIAL	塑料 Housing PA66,UL94V-2 载流体 Current carrier 锌合金,镀Cr3+钝化彩锌 Zn Alloy,Cr3+ Zn plated 螺丝 Screws 钢,镀Cr3+钝化彩锌 Steel,Cr3+ Zn plated 簧片 Wire guard 磷青铜 Phosphor	塑料 Housing PA66,UL94V-2 载流体 Current carrier 锌合金,镀Cr3+钝化彩锌 Zn Alloy,Cr3+ Zn plated 螺丝 Screws 钢,镀Cr3+钝化彩锌 Steel,Cr3+ Zn plated 簧片 Wire guard 磷青铜 Phosphor	
电气性能 ELECTRICAL	UL IEC	UL IEC	
额定电压 Rated voltage	300V 450V	300V 750V	
额定电流 Rated current	30A 41A	20A 57A	
使用线径 Wire range	14~10AWG 0.75~6.0mm <sup>2</sup>	12~8AWG 1.0~10.0mm <sup>2</sup>	

产品型号 MODEL	GT15HS	GT8HWP	GT10HWP
产品照片 Photo			
产品照片 Photo	Pole:2P-12P Pitch:15.0mm 	Pole:2P-12P Pitch:8.0mm 	Pole:2P-12P Pitch:10.0mm 
产品图纸 Plan			
材质/电镀 MATERIAL	塑料 Housing PA66,UL94V-2 载流体 Current carrier 锌合金,镀Cr3+钝化彩锌 Zn Alloy,Cr3+ Zn plated 螺丝 Screws 钢,镀Cr3+钝化彩锌 Steel,Cr3+ Zn plated 簧片 Wire guard -	塑料 Housing PA66,UL94V-2 载流体 Current carrier 锌合金,镀Cr3+钝化彩锌 Zn Alloy,Cr3+ Zn plated 螺丝 Screws 钢,镀Cr3+钝化彩锌 Steel,Cr3+ Zn plated 簧片 Wire guard -	塑料 Housing PA66,UL94V-2 载流体 Current carrier 锌合金,镀Cr3+钝化彩锌 Zn Alloy,Cr3+ Zn plated 螺丝 Screws 钢,镀Cr3+钝化彩锌 Steel,Cr3+ Zn plated 簧片 Wire guard 磷青铜 Phosphor
电气性能 ELECTRICAL	UL IEC	UL IEC	UL IEC
额定电压 Rated voltage	600V 750V	300V 450V	300V 450V
额定电流 Rated current	50A 76A	15A 24A	20A 32A
使用线径 Wire range	12~10AWG 6.0~16.0mm <sup>2</sup>	20~14AWG 0.5~2.5mm <sup>2</sup>	18~12AWG 0.5~4.0mm <sup>2</sup>

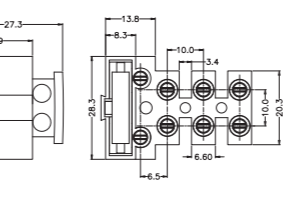
产品型号 MODEL	GT801		
产品照片 Photo			
产品照片 Photo	Pole:1P-5P Pitch:10.0mm 		
产品图纸 Plan			
材质/电镀 MATERIAL	塑料 Housing PA66,UL94V-0 螺丝 Screws M3, 钢, 镀Cr <sup>3+</sup> 钝化彩锌 M3,steel,Cr <sup>3+</sup> Zn plated 方盒 Cage 黄铜, 镀镍 Brass, Ni plated 夹子 Contact 磷青铜, 镀镍 Phosphor bronze, Ni plated 簧片 Wire guard 不锈钢 Stainless steel		
电气性能 ELECTRICAL	UL IEC		
额定电压 Rated voltage	300V 250V		
额定电流 Rated current	6.3A 6.3A		
使用线径 Wire range	22~14AWG 0.5~2.5mm <sup>2</sup>		



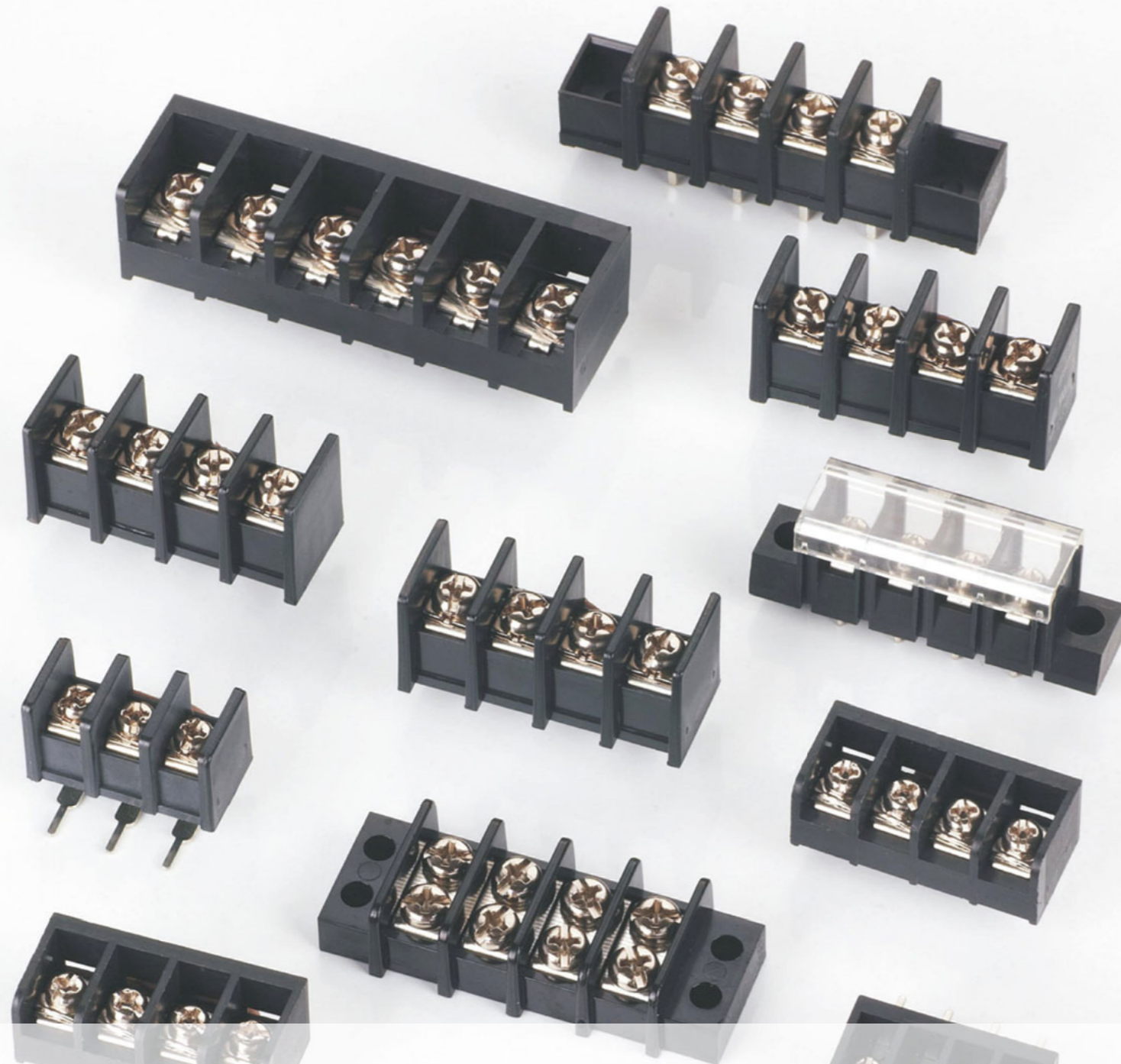









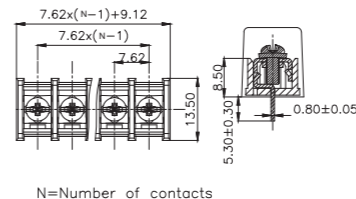
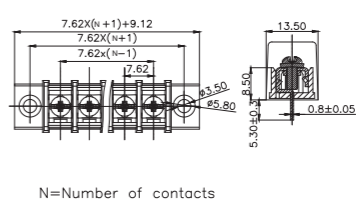
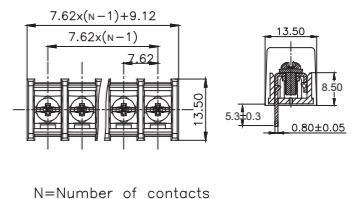

# 栅栏式接线端子 Barrier Terminal Blocks

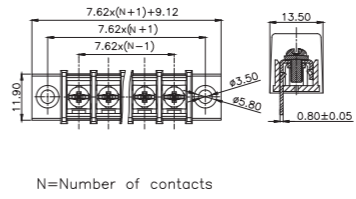
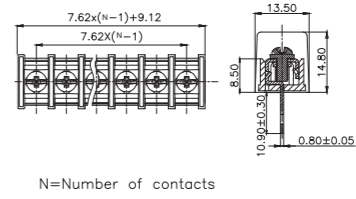
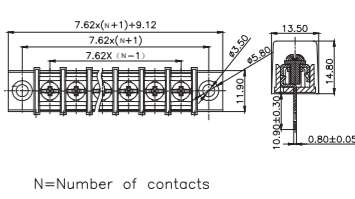

栅栏式接线端子，接线直观明了，可以连接截面为 $0.5\text{mm}^2$ 至 $6.0\text{mm}^2$ 的所有类型的导线。间距 $6.35\text{--}14\text{mm}$ 可供选择。可提供有盖、无盖等款式。产品设计符合IEC60998，UL1059等国际标准。



Barrier terminal blocks is available with different wire sizes from  $0.5\text{mm}^2$  to  $6.0\text{mm}^2$ . The pitches could be from  $6.35\text{mm}$  to  $14.0\text{mm}$ . The product is designed comply with international quality standards, such as IEC60998 and UL1059.

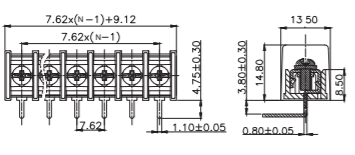
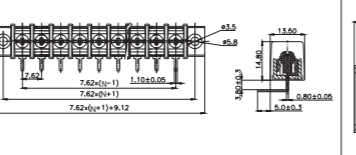
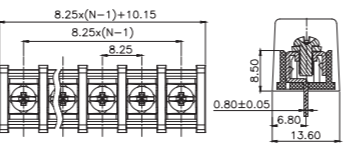

产品型号 MODEL	GT25C-B	GT25C-A	GT25S-B
产品照片 Photo			
产品图纸 Plan			
材质/电镀 MATERIAL	塑件 Housing PA66,UL94V-0 端子 Terminal 黄铜, 0.8厚 镀锡 Brass,0.8t,Tin-Plated 螺丝 Screws 钢, M3 镀镍 Steel,M3 Ni-Plated	塑件 Housing PA66,UL94V-0 端子 Terminal 黄铜, 0.8厚 镀锡 Brass,0.8t,Tin-Plated 螺丝 Screws 钢, M3 镀镍 Steel,M3 Ni-Plated	塑件 Housing PA66,UL94V-0 端子 Terminal 黄铜, 0.8厚 镀锡 Brass,0.8t,Tin-Plated 螺丝 Screws 钢, M3 镀镍 Steel,M3 Ni-Plated
电气性能 ELECTRICAL	UL IEC	UL IEC	UL IEC
额定电压 Rated voltage	300V 250V	300V 250V	300V 250V
额定电流 Rated current	15A 24A	15A 24A	15A 24A
使用线径 Wire range	22~14AWG 2.5mm <sup>2</sup>	22~14AWG 2.5mm <sup>2</sup>	22~14AWG 2.5mm <sup>2</sup>

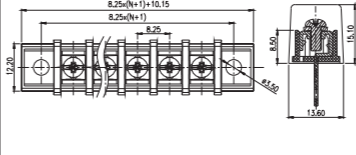
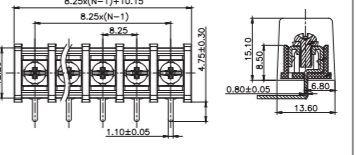
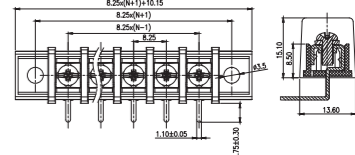
产品型号 MODEL	GT25S-A	GT25H-B	GT25H-A
产品照片 Photo			
产品图纸 Plan			
材质/电镀 MATERIAL	塑件 Housing PA66,UL94V-0 端子 Terminal 黄铜, 0.8厚 镀锡 Brass,0.8t,Tin-Plated 螺丝 Screws 钢, M3 镀镍 Steel,M3 Ni-Plated	塑件 Housing PA66,UL94V-0 端子 Terminal 黄铜, 0.8厚 镀锡 Brass,0.8t,Tin-Plated 螺丝 Screws 钢, M3 镀镍 Steel,M3 Ni-Plated	塑件 Housing PA66,UL94V-0 端子 Terminal 黄铜, 0.8厚 镀锡 Brass,0.8t,Tin-Plated 螺丝 Screws 钢, M3 镀镍 Steel,M3 Ni-Plated
电气性能 ELECTRICAL	UL IEC	UL IEC	UL IEC
额定电压 Rated voltage	300V 250V	300V 250V	300V 250V
额定电流 Rated current	15A 24A	15A 24A	15A 24A
使用线径 Wire range	22~14AWG 2.5mm <sup>2</sup>	22~14AWG 2.5mm <sup>2</sup>	22~14AWG 2.5mm <sup>2</sup>

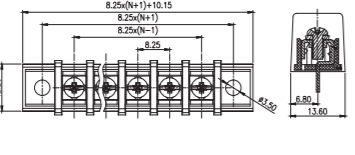
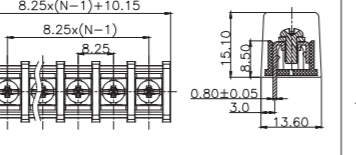
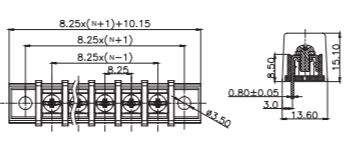

产品型号 MODEL	GT25R-B	GT25R-A	GT35C-B
产品照片 Photo			
产品图纸 Plan			
材质/电镀 MATERIAL	塑件 Housing PA66,UL94V-0 端子 Terminal 黄铜, 0.8厚 镀锡 Brass,0.8t,Tin-Plated 螺丝 Screws 钢, M3 镀镍 Steel,M3 Ni-Plated	塑件 Housing PA66,UL94V-0 端子 Terminal 黄铜, 0.8厚 镀锡 Brass,0.8t,Tin-Plated 螺丝 Screws 钢, M3 镀镍 Steel,M3 Ni-Plated	塑件 Housing PA66,UL94V-0 端子 Terminal 黄铜, 0.8厚 镀锡 Brass,0.8t,Tin-Plated 螺丝 Screws 钢, M3 镀镍 Steel,M3 Ni-Plated
电气性能 ELECTRICAL	UL IEC	UL IEC	UL IEC
额定电压 Rated voltage	300V 250V	300V 250V	300V 450V
额定电流 Rated current	15A 24A	15A 24A	20A 24A
使用线径 Wire range	22~14AWG 2.5mm <sup>2</sup>	22~14AWG 2.5mm <sup>2</sup>	22~12AWG 2.5mm <sup>2</sup>

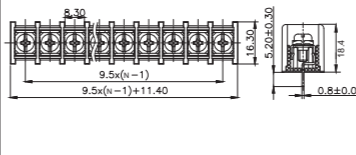
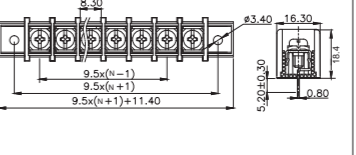
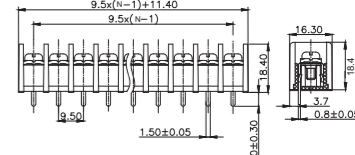

产品型号 MODEL	GT35H-A	GT35R-B	GT35R-A
产品照片 Photo			
产品图纸 Plan			
材质/电镀 MATERIAL	塑件 Housing PA66,UL94V-0 端子 Terminal 黄铜, 0.8厚 镀锡 Brass,0.8t,Tin-Plated 螺丝 Screws 钢, M3 镀镍 Steel,M3 Ni-Plated	塑件 Housing PA66,UL94V-0 端子 Terminal 黄铜, 0.8厚 镀锡 Brass,0.8t,Tin-Plated 螺丝 Screws 钢, M3 镀镍 Steel,M3 Ni-Plated	塑件 Housing PA66,UL94V-0 端子 Terminal 黄铜, 0.8厚 镀锡 Brass,0.8t,Tin-Plated 螺丝 Screws 钢, M3 镀镍 Steel,M3 Ni-Plated
电气性能 ELECTRICAL	UL IEC	UL IEC	UL IEC
额定电压 Rated voltage	300V 450V	300V 450V	300V 450V
额定电流 Rated current	20A 32A	20A 32A	20A 32A
使用线径 Wire range	22~12AWG 4.0mm <sup>2</sup>	22~12AWG 4.0mm <sup>2</sup>	22~12AWG 4.0mm <sup>2</sup>

产品型号 MODEL	GT35C-A	GT35S-B	GT35S-A
产品照片 Photo			
产品图纸 Plan			
材质/电镀 MATERIAL	塑件 Housing PA66,UL94V-0 端子 Terminal 黄铜, 0.8厚 镀锡 Brass,0.8t,Tin-Plated 螺丝 Screws 钢, M3 镀镍 Steel,M3 Ni-Plated	塑件 Housing PA66,UL94V-0 端子 Terminal 黄铜, 0.8厚 镀锡 Brass,0.8t,Tin-Plated 螺丝 Screws 钢, M3 镀镍 Steel,M3 Ni-Plated	塑件 Housing PA66,UL94V-0 端子 Terminal 黄铜, 0.8厚 镀锡 Brass,0.8t,Tin-Plated 螺丝 Screws 钢, M3 镀镍 Steel,M3 Ni-Plated
电气性能 ELECTRICAL	UL IEC	UL IEC	UL IEC
额定电压 Rated voltage	300V 450V	300V 450V	300V 450V
额定电流 Rated current	20A 32A	20A 32A	20A 32A
使用线径 Wire range	22~12AWG 4.0mm <sup>2</sup>	22~12AWG 4.0mm <sup>2</sup>	22~12AWG 4.0mm <sup>2</sup>

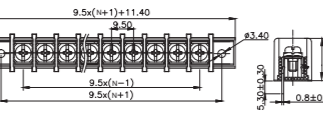
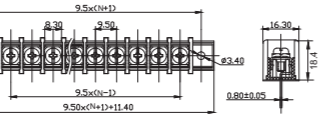
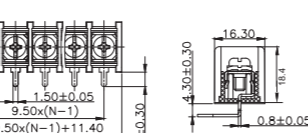

产品型号 MODEL	GT45C-B	GT45C-A	GT45S-B
产品照片 Photo			
产品图纸 Plan			
材质/电镀 MATERIAL	塑件 Housing PA66,UL94V-0 端子 Terminal 黄铜, 0.8厚 镀锡 Brass,0.8t,Tin-Plated 螺丝 Screws 钢, M4 镀镍 Steel,M4 Ni-Plated	塑件 Housing PA66,UL94V-0 端子 Terminal 黄铜, 0.8厚 镀锡 Brass,0.8t,Tin-Plated 螺丝 Screws 钢, M4 镀镍 Steel,M4 Ni-Plated	塑件 Housing PA66,UL94V-0 端子 Terminal 黄铜, 0.8厚 镀锡 Brass,0.8t,Tin-Plated 螺丝 Screws 钢, M4 镀镍 Steel,M4 Ni-Plated
电气性能 ELECTRICAL	UL IEC	UL IEC	UL IEC
额定电压 Rated voltage	300V 750V	300V 750V	300V 750V
额定电流 Rated current	25A 32A	25A 32A	25A 32A
使用线径 Wire range	22~12AWG 4.0mm <sup>2</sup>	22~12AWG 4.0mm <sup>2</sup>	22~12AWG 4.0mm <sup>2</sup>

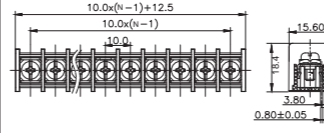
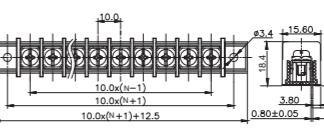
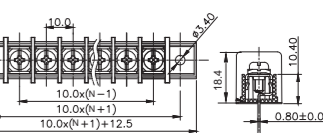

产品型号 MODEL	GT45S-A	GT45H-A	GT45R-B
产品照片 Photo			
产品图纸 Plan			
材质/电镀 MATERIAL	塑件 Housing PA66,UL94V-0 端子 Terminal 黄铜, 0.8厚 镀锡 Brass,0.8t,Tin-Plated 螺丝 Screws 钢, M4 镀镍 Steel,M4 Ni-Plated	塑件 Housing PA66,UL94V-0 端子 Terminal 黄铜, 0.8厚 镀锡 Brass,0.8t,Tin-Plated 螺丝 Screws 钢, M4 镀镍 Steel,M4 Ni-Plated	塑件 Housing PA66,UL94V-0 端子 Terminal 黄铜, 0.8厚 镀锡 Brass,0.8t,Tin-Plated 螺丝 Screws 钢, M4 镀镍 Steel,M4 Ni-Plated
电气性能 ELECTRICAL	UL IEC	UL IEC	UL IEC
额定电压 Rated voltage	300V 750V	300V 750V	300V 750V
额定电流 Rated current	25A 32A	25A 32A	25A 32A
使用线径 Wire range	22~12AWG 4.0mm <sup>2</sup>	22~12AWG 4.0mm <sup>2</sup>	22~12AWG 4.0mm <sup>2</sup>

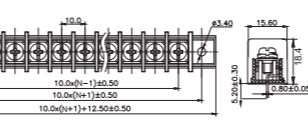
产品型号 MODEL	GT55S-B	GT55S-A	GT55H-A
产品照片 Photo			
产品图纸 Plan			
材质/电镀 MATERIAL	塑件 Housing PA66,UL94V-0 端子 Terminal 黄铜, 0.8厚 镀锡 Brass,0.8t,Tin-Plated 螺丝 Screws 钢, M4 镀镍 Steel,M4 Ni-Plated	塑件 Housing PA66,UL94V-0 端子 Terminal 黄铜, 0.8厚 镀锡 Brass,0.8t,Tin-Plated 螺丝 Screws 钢, M4 镀镍 Steel,M4 Ni-Plated	塑件 Housing PA66,UL94V-0 端子 Terminal 黄铜, 0.8厚 镀锡 Brass,0.8t,Tin-Plated 螺丝 Screws 钢, M4 镀镍 Steel,M4 Ni-Plated
电气性能 ELECTRICAL	UL IEC	UL IEC	UL IEC
额定电压 Rated voltage	300V 750V	300V 750V	300V 750V
额定电流 Rated current	20A 32A	20A 32A	20A 32A
使用线径 Wire range	22~12AWG 4.0mm <sup>2</sup>	22~12AWG 4.0mm <sup>2</sup>	22~12AWG 4.0mm <sup>2</sup>

产品型号 MODEL	GT45R-A	GT55C-B	GT55C-A
产品照片 Photo			
产品图纸 Plan			
材质/电镀 MATERIAL	塑件 Housing PA66,UL94V-0 端子 Terminal 黄铜, 0.8厚 镀锡 Brass,0.8t,Tin-Plated 螺丝 Screws 钢, M4 镀镍 Steel,M4 Ni-Plated	塑件 Housing PA66,UL94V-0 端子 Terminal 黄铜, 0.8厚 镀锡 Brass,0.8t,Tin-Plated 螺丝 Screws 钢, M4 镀镍 Steel,M4 Ni-Plated	塑件 Housing PA66,UL94V-0 端子 Terminal 黄铜, 0.8厚 镀锡 Brass,0.8t,Tin-Plated 螺丝 Screws 钢, M4 镀镍 Steel,M4 Ni-Plated
电气性能 ELECTRICAL	UL IEC	UL IEC	UL IEC
额定电压 Rated voltage	300V 750V	300V 750V	300V 750V
额定电流 Rated current	25A 32A	20A 32A	20A 32A
使用线径 Wire range	22~12AWG 4.0mm <sup>2</sup>	22~12AWG 4.0mm <sup>2</sup>	22~12AWG 4.0mm <sup>2</sup>

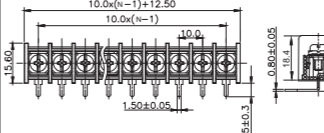
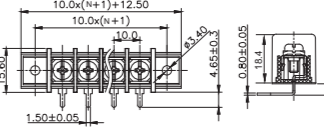
产品型号 MODEL	GT55R-B	GT55R-A	GT65C-B
产品照片 Photo			
产品图纸 Plan			
材质/电镀 MATERIAL	塑件 Housing PA66,UL94V-0 端子 Terminal 黄铜, 0.8厚 镀锡 Brass,0.8t,Tin-Plated 螺丝 Screws 钢, M4 镀镍 Steel,M4 Ni-Plated	塑件 Housing PA66,UL94V-0 端子 Terminal 黄铜, 0.8厚 镀锡 Brass,0.8t,Tin-Plated 螺丝 Screws 钢, M4 镀镍 Steel,M4 Ni-Plated	塑件 Housing PA66,UL94V-0 端子 Terminal 黄铜, 1.0厚 镀锡 Brass,1.0t,Tin-Plated 螺丝 Screws 钢, M4 镀镍 Steel,M4 Ni-Plated
电气性能 ELECTRICAL	UL IEC	UL IEC	UL IEC
额定电压 Rated voltage	300V 750V	300V 750V	300V 750V
额定电流 Rated current	20A 32A	20A 32A	20A 32A
使用线径 Wire range	22~12AWG 4.0mm <sup>2</sup>	22~12AWG 4.0mm <sup>2</sup>	22~12AWG 4.0mm <sup>2</sup>



产品型号 MODEL	GT65C-A	GT65S-B	GT65S-A
产品照片 Photo	 Pole:2-20P Pitch:11.0mm	 Pole:2-22P Pitch:11.0mm	 Pole:2-20P Pitch:11.0mm
产品图纸 Plan	 N=Number of contacts	 N=Number of contacts	 N=Number of contacts
材质/电镀 MATERIAL	塑件 Housing PA66,UL94V-0	塑件 Housing PA66,UL94V-0	塑件 Housing PA66,UL94V-0
端子 Terminal	黄铜, 1.0厚 镀锡 Brass,1.0t,Tin-Plated	黄铜, 1.0厚 镀锡 Brass,1.0t,Tin-Plated	黄铜, 1.0厚 镀锡 Brass,1.0t,Tin-Plated
螺丝 Screws	钢, M4 镀镍 Steel,M4 Ni-Plated	钢, M4 镀镍 Steel,M4 Ni-Plated	钢, M4 镀镍 Steel,M4 Ni-Plated
电气性能 ELECTRICAL	UL IEC	UL IEC	UL IEC
额定电压 Rated voltage	300V 750V	300V 750V	300V 750V
额定电流 Rated current	20A 32A	20A 32A	20A 32A
使用线径 Wire range	22~12AWG 4.0mm <sup>2</sup>	22~12AWG 4.0mm <sup>2</sup>	22~12AWG 4.0mm <sup>2</sup>



产品型号 MODEL	GT16S-B	GT16R-B	GT36S-B
产品照片 Photo	 Pole:2-24P Pitch:6.35mm	 Pole:2-24P Pitch:6.35mm	 Pole:2-24P Pitch:8.25mm
产品图纸 Plan	 N=Number of contacts	 N=Number of contacts	 N=Number of contacts
材质/电镀 MATERIAL	塑件 Housing PA66,UL94V-0	塑件 Housing PA66,UL94V-0	塑件 Housing PA66,UL94V-0
端子 Terminal	黄铜, 0.7厚 镀锡 Brass,0.7t,Tin-Plated	黄铜, 0.7厚 镀锡 Brass,0.7t,Tin-Plated	黄铜, 0.8厚 镀锡 Brass,0.8t,Tin-Plated
螺丝 Screws	钢, M2.5 镀镍 Steel,M2.5 Ni-Plated	钢, M2.5 镀镍 Steel,M2.5 Ni-Plated	钢, M3 镀镍 Steel,M3 Ni-Plated
电气性能 ELECTRICAL	UL IEC	UL IEC	UL IEC
额定电压 Rated voltage	300V 250V	300V 250V	300V 450V
额定电流 Rated current	10A 17.5A	10A 17.5A	20A 24A
使用线径 Wire range	22~16AWG 1.5mm <sup>2</sup>	22~16AWG 1.5mm <sup>2</sup>	22~12AWG 2.5mm <sup>2</sup>



产品型号 MODEL	GT65H-A	GT65R-B	GT65R-A
产品照片 Photo	 Pole:2-20P Pitch:11.0mm	 Pole:2-22P Pitch:11.0mm	 Pole:2-20P Pitch:11.0mm
产品图纸 Plan	 N=Number of contacts	 N=Number of contacts	 N=Number of contacts
材质/电镀 MATERIAL	塑件 Housing PA66,UL94V-0	塑件 Housing PA66,UL94V-0	塑件 Housing PA66,UL94V-0
端子 Terminal	黄铜, 1.0厚 镀锡 Brass,1.0t,Tin-Plated	黄铜, 1.0厚 镀锡 Brass,1.0t,Tin-Plated	黄铜, 1.0厚 镀锡 Brass,1.0t,Tin-Plated
螺丝 Screws	钢, M4 镀镍 Steel,M4 Ni-Plated	钢, M4 镀镍 Steel,M4 Ni-Plated	钢, M4 镀镍 Steel,M4 Ni-Plated
电气性能 ELECTRICAL	UL IEC	UL IEC	UL IEC
额定电压 Rated voltage	300V 750V	300V 750V	300V 750V
额定电流 Rated current	20A 32A	20A 32A	20A 32A
使用线径 Wire range	22~12AWG 4.0mm <sup>2</sup>	22~12AWG 4.0mm <sup>2</sup>	22~12AWG 4.0mm <sup>2</sup>

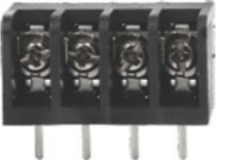
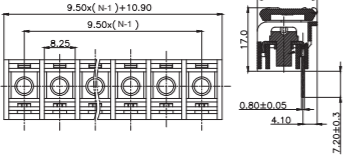
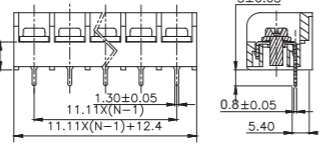
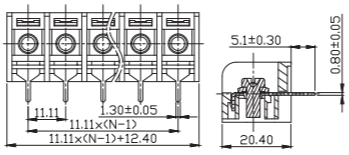

产品型号 MODEL	GT36R-B	GT46S-B	GT46R-B
产品照片 Photo	 Pole:2-22P Pitch:8.25mm	 Pole:2-24P Pitch:9.5mm	 Pole:2-24P Pitch:9.5mm
产品图纸 Plan	 N=Number of contacts	 N=Number of contacts	 N=Number of contacts
材质/电镀 MATERIAL	塑件 Housing PA66,UL94V-0	塑件 Housing PA66,UL94V-0	塑件 Housing PA66,UL94V-0
端子 Terminal	黄铜, 0.8厚 镀锡 Brass,0.8t,Tin-Plated	黄铜, 0.8厚 镀锡 Brass,0.8t,Tin-Plated	黄铜, 0.8厚 镀锡 Brass,0.8t,Tin-Plated
螺丝 Screws	钢, M3 镀镍 Steel,M3 Ni-Plated	钢, M4 镀镍 Steel,M4 Ni-Plated	钢, M4 镀镍 Steel,M4 Ni-Plated
电气性能 ELECTRICAL	UL IEC	UL IEC	UL IEC
额定电压 Rated voltage	300V 450V	300V 750V	300V 750V
额定电流 Rated current	20A 24A	20A 32A	20A 32A
使用线径 Wire range	22~12AWG 2.5mm <sup>2</sup>	22~12AWG 4.0mm <sup>2</sup>	22~12AWG 4.0mm <sup>2</sup>

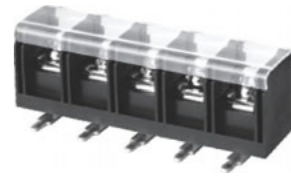
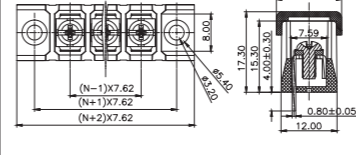
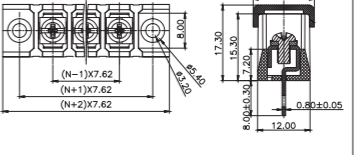
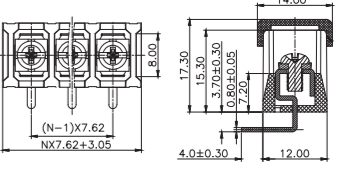



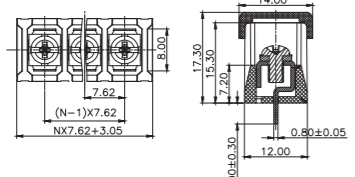
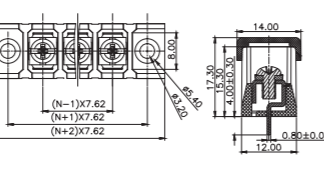
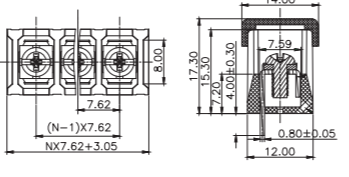

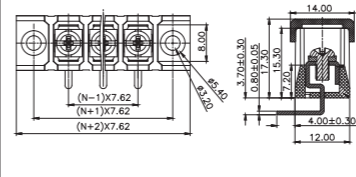
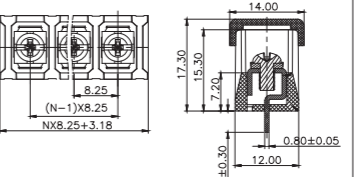
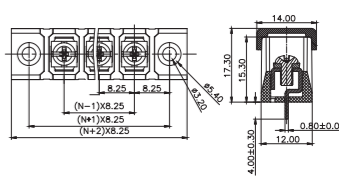

产品型号 MODEL	GT46GS-B	GT66S-B	GT66R-B
产品照片 Photo			
产品图纸 Plan			
材质/电镀 MATERIAL	塑件 Housing PA66,UL94V-0 端子 Terminal 黄铜, 0.8厚 镀锡 Brass,0.8t,Tin-Plated 螺丝 Screws 钢, M4 镀镍 Steel,M4 Ni-Plated	塑件 Housing PA66,UL94V-0 端子 Terminal 黄铜, 0.8厚 镀锡 Brass,0.8t,Tin-Plated 螺丝 Screws 钢, M4 镀镍 Steel,M4 Ni-Plated	塑件 Housing PA66,UL94V-0 端子 Terminal 黄铜, 0.8厚 镀锡 Brass,0.8t,Tin-Plated 螺丝 Screws 钢, M4 镀镍 Steel,M4 Ni-Plated
电气性能 ELECTRICAL	UL IEC	UL IEC	UL IEC
额定电压 Rated voltage	300V 750V	300V 450V	300V 450V
额定电流 Rated current	20A 32A	30A 41A	30A 41A
使用线径 Wire range	20~12AWG 4.0mm <sup>2</sup>	22~10AWG 4.0mm <sup>2</sup>	22~10AWG 6.0mm <sup>2</sup>

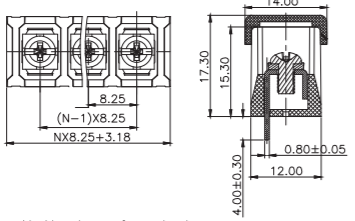
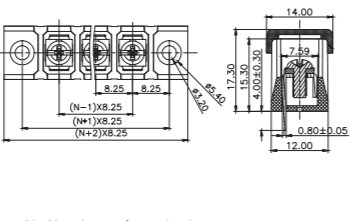
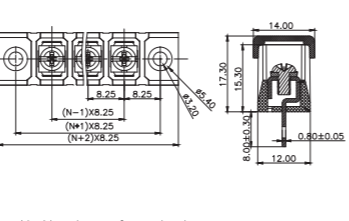

产品型号 MODEL	GT28S-A	GT28H-A	GT28R-B
产品照片 Photo			
产品图纸 Plan			
材质/电镀 MATERIAL	塑件 Housing PA66+23%GF, UL 94V-0 端子 Terminal 黄铜, 0.8厚 镀锡 Brass,0.8t,Tin-Plated 螺丝 Screws 钢, M3 镀镍 Steel,M3 Ni-Plated	塑件 Housing PA66+23%GF, UL 94V-0 端子 Terminal 黄铜, 0.8厚 镀锡 Brass,0.8t,Tin-Plated 螺丝 Screws 钢, M3 镀镍 Steel,M3 Ni-Plated	塑件 Housing PA66+23%GF, UL 94V-0 端子 Terminal 黄铜, 0.8厚 镀锡 Brass,0.8t,Tin-Plated 螺丝 Screws 钢, M3 镀镍 Steel,M3 Ni-Plated
电气性能 ELECTRICAL	UL IEC	UL IEC	UL IEC
额定电压 Rated voltage	300V 250V	300V 250V	300V 250V
额定电流 Rated current	15A 24A	15A 24A	15A 24A
使用线径 Wire range	22~14AWG 2.5mm <sup>2</sup>	22~14AWG 2.5mm <sup>2</sup>	22~14AWG 2.5mm <sup>2</sup>

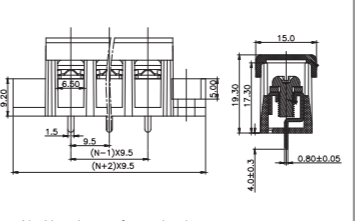
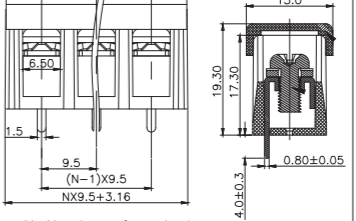
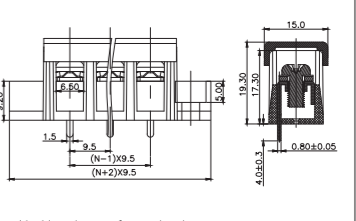

产品型号 MODEL	GT28C-B	GT28C-A	GT28S-B
产品照片 Photo			
产品图纸 Plan			
材质/电镀 MATERIAL	塑件 Housing PA66+23%GF, UL 94V-0 端子 Terminal 黄铜, 0.8厚 镀锡 Brass,0.8t,Tin-Plated 螺丝 Screws 钢, M3 镀镍 Steel,M3 Ni-Plated	塑件 Housing PA66+23%GF, UL 94V-0 端子 Terminal 黄铜, 0.8厚 镀锡 Brass,0.8t,Tin-Plated 螺丝 Screws 钢, M3 镀镍 Steel,M3 Ni-Plated	塑件 Housing PA66+23%GF, UL 94V-0 端子 Terminal 黄铜, 0.8厚 镀锡 Brass,0.8t,Tin-Plated 螺丝 Screws 钢, M3 镀镍 Steel,M3 Ni-Plated
电气性能 ELECTRICAL	UL IEC	UL IEC	UL IEC
额定电压 Rated voltage	300V 250V	300V 250V	300V 250V
额定电流 Rated current	15A 24A	15A 24A	15A 24A
使用线径 Wire range	22~14AWG 2.5mm <sup>2</sup>	22~14AWG 2.5mm <sup>2</sup>	22~14AWG 2.5mm <sup>2</sup>

产品型号 MODEL	GT28R-A	GT38C-B	GT38C-A
产品照片 Photo			
产品图纸 Plan			
材质/电镀 MATERIAL	塑件 Housing PA66+23%GF, UL 94V-0 端子 Terminal 黄铜, 0.8厚 镀锡 Brass,0.8t,Tin-Plated 螺丝 Screws 钢, M3 镀镍 Steel,M3 Ni-Plated	塑件 Housing PA66+23%GF, UL 94V-0 端子 Terminal 黄铜, 0.8厚 镀锡 Brass,0.8t,Tin-Plated 螺丝 Screws 钢, M3 镀镍 Steel,M3 Ni-Plated	塑件 Housing PA66+23%GF, UL 94V-0 端子 Terminal 黄铜, 0.8厚 镀锡 Brass,0.8t,Tin-Plated 螺丝 Screws 钢, M3 镀镍 Steel,M3 Ni-Plated
电气性能 ELECTRICAL	UL IEC	UL IEC	UL IEC
额定电压 Rated voltage	300V 250V	300V 450V	300V 450V
额定电流 Rated current	15A 24A	15A 24A	15A 24A
使用线径 Wire range	22~14AWG 2.5mm <sup>2</sup>	22~14AWG 2.5mm <sup>2</sup>	22~14AWG 2.5mm <sup>2</sup>

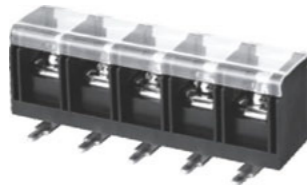

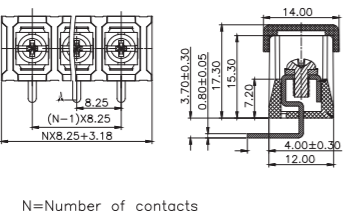
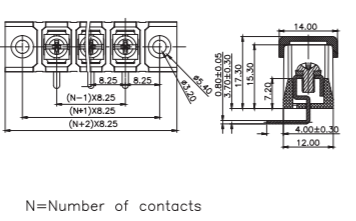
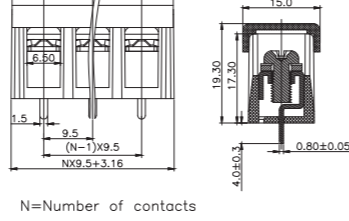
产品型号 MODEL	GT38S-B	GT38S-A	GT38H-A
产品照片 Photo			
产品图纸 Plan			
材质/电镀 MATERIAL	塑件 Housing PA66+23%GF, UL 94V-0 端子 Terminal 黄铜, 0.8厚 镀锡 Brass,0.8t,Tin-Plated 螺丝 Screws 钢, M3 镀镍 Steel,M3 Ni-Plated	塑件 Housing PA66+23%GF, UL 94V-0 端子 Terminal 黄铜, 0.8厚 镀锡 Brass,0.8t,Tin-Plated 螺丝 Screws 钢, M3 镀镍 Steel,M3 Ni-Plated	塑件 Housing PA66+23%GF, UL 94V-0 端子 Terminal 黄铜, 0.8厚 镀锡 Brass,0.8t,Tin-Plated 螺丝 Screws 钢, M3 镀镍 Steel,M3 Ni-Plated
电气性能 ELECTRICAL	UL IEC	UL IEC	UL IEC
额定电压 Rated voltage	300V 450V	300V 450V	300V 450V
额定电流 Rated current	15A 24A	15A 24A	15A 24A
使用线径 Wire range	22~14AWG 2.5mm <sup>2</sup>	22~14AWG 2.5mm <sup>2</sup>	22~14AWG 2.5mm <sup>2</sup>

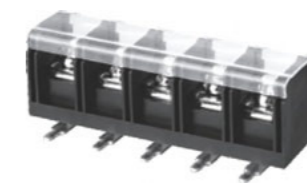

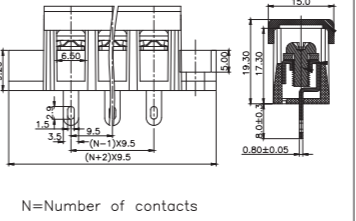
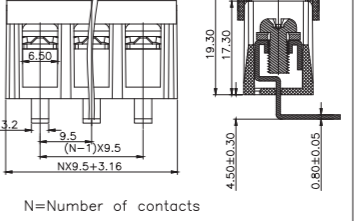
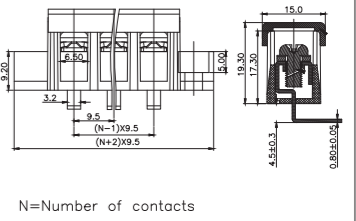
产品型号 MODEL	GT48C-A	GT48S-B	GT48S-A
产品照片 Photo			
产品图纸 Plan			
材质/电镀 MATERIAL	塑件 Housing PA66+23%GF, UL 94V-0 端子 Terminal 黄铜, 0.8厚 镀锡 Brass,0.8t,Tin-Plated 螺丝 Screws 钢, M4 镀镍 Steel,M4 Ni-Plated	塑件 Housing PA66+23%GF, UL 94V-0 端子 Terminal 黄铜, 0.8厚 镀锡 Brass,0.8t,Tin-Plated 螺丝 Screws 钢, M4 镀镍 Steel,M4 Ni-Plated	塑件 Housing PA66+23%GF, UL 94V-0 端子 Terminal 黄铜, 0.8厚 镀锡 Brass,0.8t,Tin-Plated 螺丝 Screws 钢, M4 镀镍 Steel,M4 Ni-Plated
电气性能 ELECTRICAL	UL IEC	UL IEC	UL IEC
额定电压 Rated voltage	300V 750V	300V 750V	300V 750V
额定电流 Rated current	20A 32A	20A 32A	20A 32A
使用线径 Wire range	22~12AWG 4.0mm <sup>2</sup>	22~12AWG 4.0mm <sup>2</sup>	22~12AWG 4.0mm <sup>2</sup>



产品型号 MODEL	GT38R-B	GT38R-A	GT48C-B
产品照片 Photo			
产品图纸 Plan			
材质/电镀 MATERIAL	塑件 Housing PA66+23%GF, UL 94V-0 端子 Terminal 黄铜, 0.8厚 镀锡 Brass,0.8t,Tin-Plated 螺丝 Screws 钢, M3 镀镍 Steel,M3 Ni-Plated	塑件 Housing PA66+23%GF, UL 94V-0 端子 Terminal 黄铜, 0.8厚 镀锡 Brass,0.8t,Tin-Plated 螺丝 Screws 钢, M3 镀镍 Steel,M3 Ni-Plated	塑件 Housing PA66+23%GF, UL 94V-0 端子 Terminal 黄铜, 0.8厚 镀锡 Brass,0.8t,Tin-Plated 螺丝 Screws 钢, M4 镀镍 Steel,M4 Ni-Plated
电气性能 ELECTRICAL	UL IEC	UL IEC	UL IEC
额定电压 Rated voltage	300V 450V	300V 450V	300V 750V
额定电流 Rated current	15A 24A	15A 24A	20A 32A
使用线径 Wire range	22~14AWG 2.5mm <sup>2</sup>	22~14AWG 2.5mm <sup>2</sup>	22~12AWG 4.0mm <sup>2</sup>

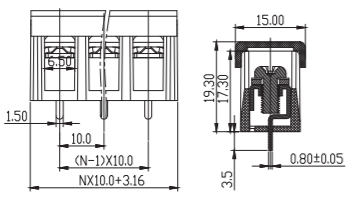
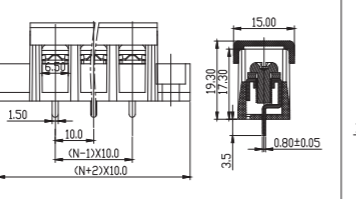
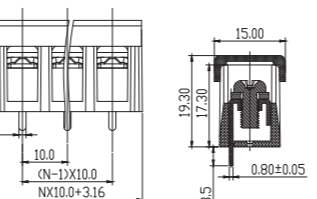

产品型号 MODEL	GT48H-A	GT48R-B	GT48R-A
产品照片 Photo			
产品图纸 Plan			
材质/电镀 MATERIAL	塑件 Housing PA66+23%GF, UL 94V-0 端子 Terminal 黄铜, 0.8厚 镀锡 Brass,0.8t,Tin-Plated 螺丝 Screws 钢, M4 镀镍 Steel,M4 Ni-Plated	塑件 Housing PA66+23%GF, UL 94V-0 端子 Terminal 黄铜, 0.8厚 镀锡 Brass,0.8t,Tin-Plated 螺丝 Screws 钢, M4 镀镍 Steel,M4 Ni-Plated	塑件 Housing PA66+23%GF, UL 94V-0 端子 Terminal 黄铜, 0.8厚 镀锡 Brass,0.8t,Tin-Plated 螺丝 Screws 钢, M4 镀镍 Steel,M4 Ni-Plated
电气性能 ELECTRICAL	UL IEC	UL IEC	UL IEC
额定电压 Rated voltage	300V 750V	300V 750V	300V 750V
额定电流 Rated current	20A 32A	20A 32A	20A 32A
使用线径 Wire range	22~12AWG 4.0mm <sup>2</sup>	22~12AWG 4.0mm <sup>2</sup>	22~12AWG 4.0mm <sup>2</sup>

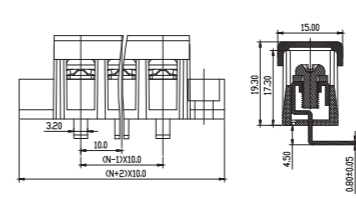
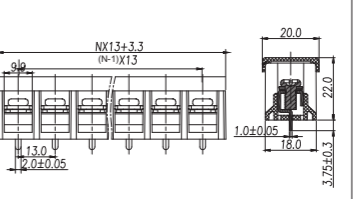
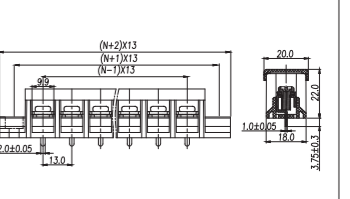

产品型号 MODEL	GT58C-B	GT58C-A	GT58S-B
产品照片 Photo	 Pole:2-22P Pitch:10.0mm	 Pole:2-20P Pitch:10.0mm	 Pole:2-22P Pitch:10.0mm
产品图纸 Plan	 N=Number of contacts	 N=Number of contacts	 N=Number of contacts
材质/电镀 MATERIAL	塑件 Housing PA66+23%GF, UL 94V-0 端子 Terminal 黄铜, 0.8厚 镀锡 Brass,0.8t,Tin-Plated 螺丝 Screws 钢, M4 镀镍 Steel,M4 Ni-Plated	塑件 Housing PA66+23%GF, UL 94V-0 端子 Terminal 黄铜, 0.8厚 镀锡 Brass,0.8t,Tin-Plated 螺丝 Screws 钢, M4 镀镍 Steel,M4 Ni-Plated	塑件 Housing PA66+23%GF, UL 94V-0 端子 Terminal 黄铜, 0.8厚 镀锡 Brass,0.8t,Tin-Plated 螺丝 Screws 钢, M4 镀镍 Steel,M4 Ni-Plated
电气性能 ELECTRICAL	UL IEC 额定电压 Rated voltage 300V 750V 额定电流 Rated current 20A 32A 使用线径 Wire range 22~12AWG 4.0mm <sup>2</sup>	UL IEC 额定电压 Rated voltage 300V 750V 额定电流 Rated current 20A 32A 使用线径 Wire range 22~12AWG 4.0mm <sup>2</sup>	UL IEC 额定电压 Rated voltage 300V 750V 额定电流 Rated current 20A 32A 使用线径 Wire range 22~12AWG 4.0mm <sup>2</sup>

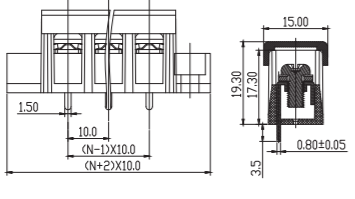
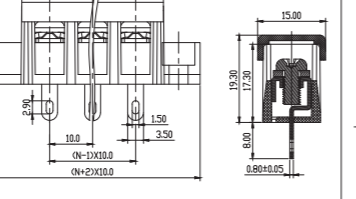
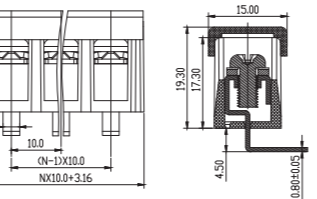
产品型号 MODEL	GT58R-A	GT78C-B	GT78C-A
产品照片 Photo	 Pole:2-20P Pitch:13.0mm	 Pole:2-20P Pitch:13.0mm	 Pole:2-18P Pitch:13.0mm
产品图纸 Plan	 N=Number of contacts	 N=Number of contacts	 N=Number of contacts
材质/电镀 MATERIAL	塑件 Housing PA66+23%GF, UL 94V-0 端子 Terminal 黄铜, 0.8厚 镀锡 Brass,0.8t,Tin-Plated 螺丝 Screws 钢, M4 镀镍 Steel,M4 Ni-Plated	塑件 Housing PA66+23%GF, UL 94V-0 端子 Terminal 黄铜, 1.0厚 镀锡 Brass,1.0t,Tin-Plated 螺丝 Screws 钢, M4 镀镍 Steel,M4 Ni-Plated	塑件 Housing PA66+23%GF, UL 94V-0 端子 Terminal 黄铜, 1.0厚 镀锡 Brass,1.0t,Tin-Plated 螺丝 Screws 钢, M4 镀镍 Steel,M4 Ni-Plated
电气性能 ELECTRICAL	UL IEC 额定电压 Rated voltage 300V 750V 额定电流 Rated current 20A 32A 使用线径 Wire range 22~12AWG 4.0mm <sup>2</sup>	UL IEC 额定电压 Rated voltage 600V 750V 额定电流 Rated current 40A 41A 使用线径 Wire range 18~10AWG 6.0mm <sup>2</sup>	UL IEC 额定电压 Rated voltage 600V 750V 额定电流 Rated current 40A 41A 使用线径 Wire range 18~10AWG 6.0mm <sup>2</sup>

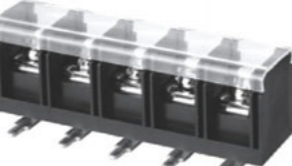
产品型号 MODEL	GT58S-A	GT58H-A	GT58R-B
产品照片 Photo	 Pole:2-20P Pitch:10.0mm	 Pole:2-20P Pitch:10.0mm	 Pole:2-22P Pitch:10.0mm
产品图纸 Plan	 N=Number of contacts	 N=Number of contacts	 N=Number of contacts
材质/电镀 MATERIAL	塑件 Housing PA66+23%GF, UL 94V-0 端子 Terminal 黄铜, 0.8厚 镀锡 Brass,0.8t,Tin-Plated 螺丝 Screws 钢, M4 镀镍 Steel,M4 Ni-Plated	塑件 Housing PA66+23%GF, UL 94V-0 端子 Terminal 黄铜, 0.8厚 镀锡 Brass,0.8t,Tin-Plated 螺丝 Screws 钢, M4 镀镍 Steel,M4 Ni-Plated	塑件 Housing PA66+23%GF, UL 94V-0 端子 Terminal 黄铜, 0.8厚 镀锡 Brass,0.8t,Tin-Plated 螺丝 Screws 钢, M4 镀镍 Steel,M4 Ni-Plated
电气性能 ELECTRICAL	UL IEC 额定电压 Rated voltage 300V 750V 额定电流 Rated current 20A 32A 使用线径 Wire range 22~12AWG 4.0mm <sup>2</sup>	UL IEC 额定电压 Rated voltage 300V 750V 额定电流 Rated current 20A 32A 使用线径 Wire range 22~12AWG 4.0mm <sup>2</sup>	UL IEC 额定电压 Rated voltage 300V 750V 额定电流 Rated current 20A 32A 使用线径 Wire range 22~12AWG 4.0mm <sup>2</sup>

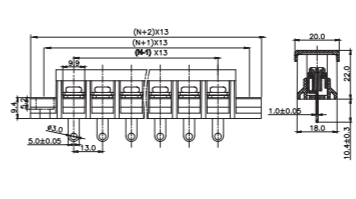
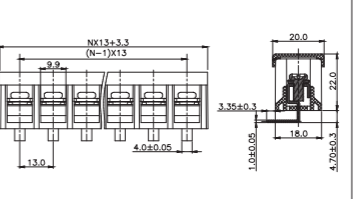
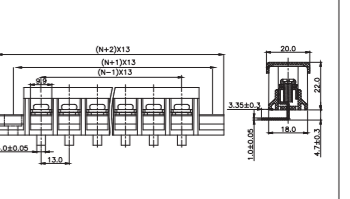
产品型号 MODEL	GT78H-A	GT78R-B	GT78R-A
产品照片 Photo	 Pole:2-18P Pitch:13.0mm	 Pole:2-20P Pitch:13.0mm	 Pole:2-18P Pitch:13.0mm
产品图纸 Plan	 N=Number of contacts	 N=Number of contacts	 N=Number of contacts
材质/电镀 MATERIAL	塑件 Housing PA66+23%GF, UL 94V-0 端子 Terminal 黄铜, 1.0厚 镀锡 Brass,1.0t,Tin-Plated 螺丝 Screws 钢, M4 镀镍 Steel,M4 Ni-Plated	塑件 Housing PA66+23%GF, UL 94V-0 端子 Terminal 黄铜, 1.0厚 镀锡 Brass,1.0t,Tin-Plated 螺丝 Screws 钢, M4 镀镍 Steel,M4 Ni-Plated	塑件 Housing PA66+23%GF, UL 94V-0 端子 Terminal 黄铜, 1.0厚 镀锡 Brass,1.0t,Tin-Plated 螺丝 Screws 钢, M4 镀镍 Steel,M4 Ni-Plated
电气性能 ELECTRICAL	UL IEC 额定电压 Rated voltage 600V 750V 额定电流 Rated current 40A 41A 使用线径 Wire range 18~10AWG 6.0mm <sup>2</sup>	UL IEC 额定电压 Rated voltage 600V 750V 额定电流 Rated current 40A 41A 使用线径 Wire range 18~10AWG 6.0mm <sup>2</sup>	UL IEC 额定电压 Rated voltage 600V 750V 额定电流 Rated current 40A 41A 使用线径 Wire range 18~10AWG 6.0mm <sup>2</sup>

产品型号 MODEL	GT49-A	GT69-A	GT89-A
产品照片 Photo			
产品图纸 Plan			
材质/电镀 MATERIAL	塑件 Housing: PC, UL 94V-2 端子 Terminal: 黄铜, 0.8厚 镀锡 / Brass, 0.8t, Tin-Plated 螺丝 Screws: 钢, M3.5 镀镍 / Steel, M3.5 Ni-Plated	塑件 Housing: PC, UL 94V-2 端子 Terminal: 黄铜, 0.8厚 镀锡 / Brass, 0.8t, Tin-Plated 螺丝 Screws: 钢, M3.5 镀镍 / Steel, M3.5 Ni-Plated	塑件 Housing: PC, UL 94V-2 端子 Terminal: 黄铜, 0.8厚 镀锡 / Brass, 0.8t, Tin-Plated 螺丝 Screws: 钢, M4 镀镍 / Steel, M4 Ni-Plated
电气性能 ELECTRICAL	UL IEC	UL IEC	UL IEC
额定电压 Rated voltage	300V 450V	300V 750V	600V 750V
额定电流 Rated current	20A 32A	25A 32A	30A 41A
使用线径 Wire range	22~12AWG 4.0mm <sup>2</sup>	22~12AWG 4.0mm <sup>2</sup>	22~10AWG 6.0mm <sup>2</sup>

产品型号 MODEL	GT24-1	GT24-2	GT44B-1
产品照片 Photo			
产品图纸 Plan			
材质/电镀 MATERIAL	塑件 Housing: PA66+23%GF, UL 94V-0 端子 Terminal: 黄铜, 0.8厚 镀锡 / Brass, 0.8t, Tin-Plated 螺丝 Screws: 钢, M3 镀镍 / Steel, M3 Ni-Plated	塑件 Housing: PA66+23%GF, UL 94V-0 端子 Terminal: 黄铜, 0.8厚 镀锡 / Brass, 0.8t, Tin-Plated 螺丝 Screws: 钢, M3 镀镍 / Steel, M3 Ni-Plated	塑件 Housing: PA66+23%GF, UL 94V-0 端子 Terminal: 黄铜, 0.8厚 镀锡 / Brass, 0.8t, Tin-Plated 螺丝 Screws: 钢, M3.5 镀镍 / Steel, M3.5 Ni-Plated
电气性能 ELECTRICAL	UL IEC	UL IEC	UL IEC
额定电压 Rated voltage	300V 250V	300V 250V	300V 250V
额定电流 Rated current	15A 17.5A	15A 17.5A	15A 24A
使用线径 Wire range	22~14AWG 2.5mm <sup>2</sup>	22~14AWG 2.5mm <sup>2</sup>	22~14AWG 2.5mm <sup>2</sup>



## OEM/ODM产品 OEM/ODM Products

公司拥有专业素养的科研团队，强大的技术研发中心、模具制造中心、生产加工中心，能快速把握客户需求，为广大客户提供OEM/ODM产品。

With the professional technology and advanced equipment, GOLTEN could provide OEM/ODM products for customers.