

# 2018 BLACK BOOK

**“DESIGN  
IS THE  
COMBINATION  
OF  
HARMONY,  
BALANCE,  
AND  
CONFLICTS,**

**WHILE  
QUALITY  
IS THE  
REFLECTION  
OF  
RESPONSIBILITIES,  
CONCENTRATE,  
AND  
EXPERTISE”**

Simply, we are  
manufacturer  
and designing  
company  
of led lighting  
and have been  
doing well in  
this business  
over decade.

Check  
our profile  
through  
our partner  
worldwide

And seriously,  
**WE ARE NOT  
TRADERS.**

We have all  
facilities making  
the lamps  
we designed  
And more  
important,  
we provide  
OEM&ODM  
service to  
our partners  
all over the world



**ALL LED IN THE**



# THE BLACK BOOK

Sample page

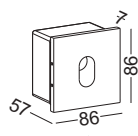

code **LSL011** ◀

casing aluminum / anodized silver ◀

lamping LED 1W / Ra>80 / 70LM ◀

Beam 60 degree / no lense ◀

2700K/3000K/4000K/6000K ◀

installation ◀

installed with standard 86x86mm switch box ◀

supply with standard 86mm switch box ◀

surface customizable black paint equal to RAL9011 ◀

Descriptions

- |   |   |   |
|---|---|---|
| <p>① product photo</p> <p>② product measurements size line drawing</p> <p>③ product item No.</p> <p>④ lamp material and lamp finishing and color.</p> | <p>⑤ lamp power / color rendering index lumen output ( after chip,before lense or reflector)</p> <p>⑥ lens or reflector angle the angle listed is available option, while the number covered by grey block is the default lens or reflector angle</p> <p>⑦ led color the CCT listed is available option, while the CCT covered by grey block is the default LED color</p> | <p>⑧ installation involved icons check below remarks</p> <p>⑨ cut-off size for the lamp or installation box when there is any need only showed in a recessed lamp</p> <p>⑩ comments about the lamp</p> <p>⑪ custom-made lamp finishings or colors available</p> <p>⑫ rotate angle vertical and horizontal</p> |
|---|---|---|

Icons

<p>installation positions</p> <ul style="list-style-type: none"> <li> wall surface mount</li> <li> ceiling surface mount</li> <li> pendant surface mount</li> <li> wall recessed mount</li> <li> ceiling recessed mount</li> <li> track installation</li> <li> inground installation</li> <li> ground surface mount</li> <li> table/floor lamp</li> </ul>	<p>electrical isolation classes</p> <ul style="list-style-type: none"> <li> class I / earth connected</li> <li> class II / without earth connected but double isolation</li> <li> lamp working in low volatage</li> </ul>	<p>other icons</p> <ul style="list-style-type: none"> <li> cut-off size for recessed installation</li> <li> fixture can be installed on the flammable surface</li> <li> ce approved / listed</li> <li> vertical rotate angle</li> <li> horizontal rotate angle</li> </ul>	<p>protection degree</p> <ul style="list-style-type: none"> <li><b>IP20</b> protected against solid object diameter&gt; 12mm no resistant to any water</li> <li><b>IP44</b> protected against solid object diameter&gt; 1mm and splash-proof</li> <li><b>IP65</b> dust tight and jet-proof</li> <li><b>IP67</b> dust-tight and water-tight</li> </ul>
---	---	---	---

## FINISHINGS AND COLORS

### anodization



anodized silver original



anodized silver brushed circular



anodized gold brushed circular



anodized silver brushed linear

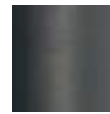

anodized black sandblasted



anodized silver sandblasted

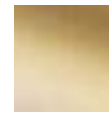

anodized gold sandblasted

### powder coating



black paint equal to RAL9011



white paint similar to RAL9003



concrete grey similar to RAL7037

### electrical plating



chrome plated



gold plated

## LIGHT EMISSION ANGLE

### narrow beam



lens



lens / reflector



lens

### spot



lens



reflector



reflector

### flood



lens



reflector

### wide flood



lens / reflector

## DIMMING TECHNOLOGY

### ■ TRIAC DIMMING

Most lamp in the book can be custom made to TRIAC dimming driver / dimming from 3watt to 40watt / dimming from 10% to 100%

Compatible with most of system in the market such as SIEMENS/PHILIPS/SCHNEIDER/LUTRON/OSRAM/ABB and etc.

Compatible with trail edge and leading edge / Dimming with NO FLASHING

Need a TRIAC dimmer supplied by qualified supplier to operate the dimming system

Advantage: easy wiring, low cost system and dimmer / Disadvantage: always compatibility problems

### ■ 0/1-10V DIMMING

Due to the big size of 0/1-10V dimming driver, not all lamp can changed to this type of dimming driver, please consult with our engineer for more info.

Dimming by special system and dimmer through two positive and negative control cable

Advantage: no compatibility problem / Disadvantage: high cost of system and wiring of control cable

### ■ DALI SYSTEM

Dimming and controlled by DALI PROTOCOL

due to the big size of the driver, not all lamp can changed to this type of dimming driver, please consult with our engineer for more info.

Advantage: no compatibility problem, good dimming effect, long distance control / Disadvantage: high cost of system and driver



# CATEGORIES

## Residential Part

---



LED DECORATIVE LIGHTS  
PAGE 33-56



LED SURFACE WALL LIGHTS  
PAGE 62-109



LED STEP LIGHTS  
PAGE 114-120



LED READING LIGHTS  
PAGE 124-161



LED BATHROOM LIGHTS  
PAGE 164-175



LED PENDANT LIGHTS  
PAGE 178-273



LED SURFACE DOWN LIGHTS  
PAGE 276-329



LED CHANDELIER  
PAGE 331-353



LED TABLE/FLOOR LAMPS  
PAGE 355-365

## Office Part

---



LED OFFICE PENDANT LIGHTS  
PAGE 366-385



LED PANEL LIGHTS  
PAGE 386-393

## Architecture Part

---



LED SURFACE SPOT LIGHTS  
PAGE 394-419



LED TRACK LIGHTS  
PAGE 420-451



LED RECESSED SPOT LIGHTS  
PAGE 452-489



LED GRILLE LIGHTS  
PAGE 490-515



LED RECESSED DOWN LIGHTS  
PAGE 516-525



LED CABINET LIGHTS  
PAGE 526-535

## Outdoor Part

---



LED OUTDOOR WALL LIGHTS  
PAGE 536-571



LED OUTDOOR INGROUND LIGHTS  
PAGE 572-583



LED OUTDOOR SPOT LIGHTS  
PAGE 584-589



LED GARDEN LIGHTS  
PAGE 590-599



LED OUTDOOR RECESSED AND SURFACE DOWN LIGHTS  
PAGE 600-603

## Basic light and GU10/AR111 Lamp Casing

---



LED TUBES/STRIPS/BULBS  
PAGE 604-617



GU10 CASING  
PAGE 618-627



AR111 LAMP CASING  
PAGE 628-644



# INDEX

## RESIDENTIAL PART

### LED DECORATIVE LIGHTS



LWA158 P33 LWA159 P34 LWA160 P34 LWA156 P36 LWA157 P35 LWA166 P37 LWA167 P38

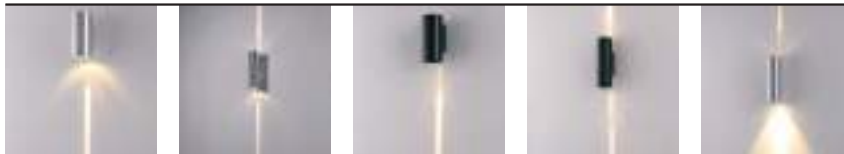

LWA276-SL P39 LWA277-SL P39 LWA276-BK P40 LWA277-BK P40 LWA278-SL P41

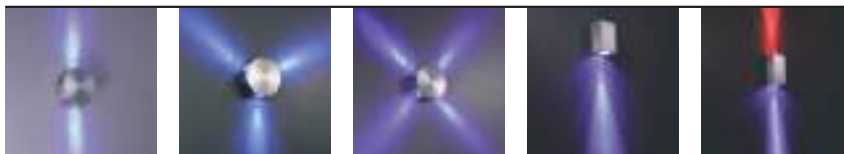

LWA027 P44 LWA028 P44 LWA029 P44 HL025/1 P45 HL025/2 P46

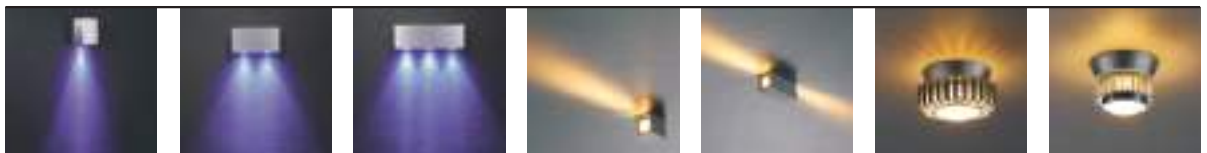

LWA071 P47 LWA072 P47 LWA073 P47 LDC908 P48 LDC909 P48 HL8022L P50 HL8004L P50

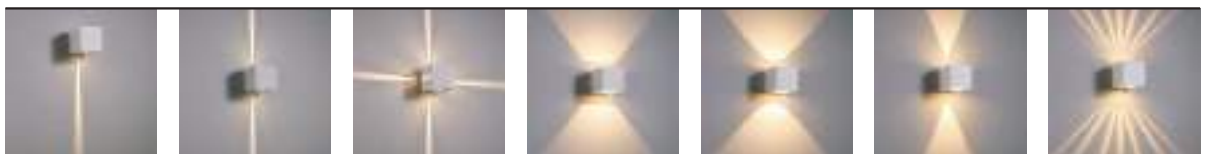

LWA300A-WT P52 LWA300B-WT P52 LWA300C-WT P53 LWA300D-WT P54 LWA300E-WT P54 LWA300F-WT P55 LWA300G-WT P55



LWA300H-WT P56 LWA300J-WT P56

### LED WALL LIGHTS SURFACE MOUNT



LWA051 P62 LWA052 P62 LWA106 P63 LWA138 P64 LWA183 P65 LWA182 P65 LWA184 P66



LWA185 P66 HL004/1 P67 HL004/2 P67 LWA101 P68 LWA103 P68 LWA105 P68

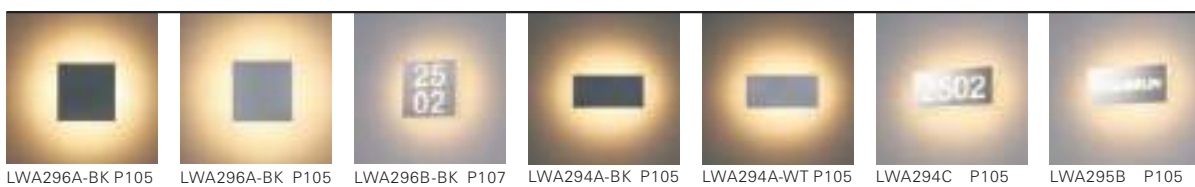
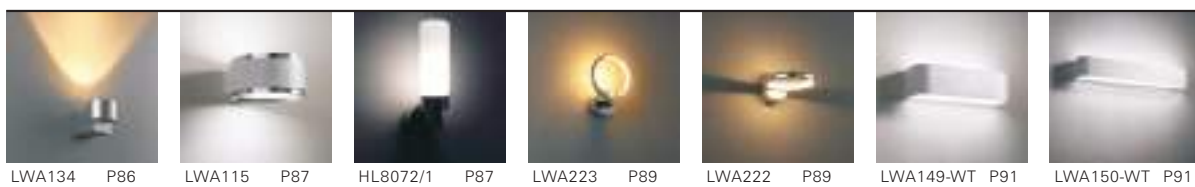

LED  
STEP  
LIGHTS

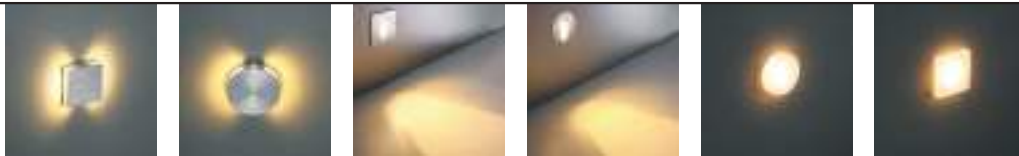

LSL003 P114    LSL004 P114    LSL001 P113    LSL002 P113    LSL009 P116    LSL008 P116



LSL009A P117    LSL008A P117    LSL013 P119    LSL011 P119    LSL013A P120    LSL011A P120    LSL012A P120

LED  
READING  
LIGHTS



LWA219-WT P124    LWA219-BK P124    LWA219-SL P124    LWA219-CR P124    LWA219-RG P124    LWA220-WT P125    LWA220-BK P125



LWA220-SL P126    LWA220-CR P125    LWA319-WT P128    LWA319-BK P128    LWA319-SL P128    LWA319-CR P128



LWA320-WT P128    LWA320-BK P128    LWA320-SL P128    LWA320-CR P128    LWA260-BK P130    LWA260-WT P130    LWA260-CR P130



LWA259-BK P131    LWA259-WT P131    LWA259-CR P131    LWA322-CR P132    LWA322-GD P133    LWA322-WT P133    LWA322-BK P133



LWA321-CR P134    LWA321-GD P135    LWA321-WT P135    LWA321-BK P135    LWA315-WT P136    LWA315-BK P136    LWA315-CR P136



LWA314-WT P137    LWA314-BK P137    LWA314-CR P137    LWA317-WT P138    LWA317-BK P138    LWA317-CR P138



LWA316-WT P139    LWA316-BK P139    LWA316-CR P138    LWA205 P141    LWA206 P141    LWA203 P141    LWA204 P141



LED  
BATHROOM  
LIGHTS



LED  
PENDANT  
LIGHTS

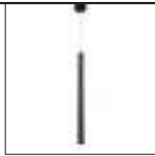

HL012-BK P179

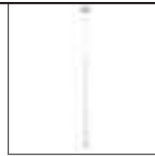

HL012-WT P178

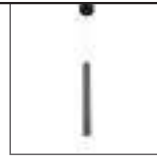

LPL045-BK P184

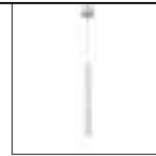

LPL045-WT P185

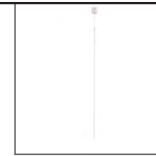

LPL201-WT P188

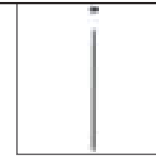

LPL201-BK P188

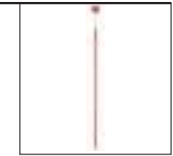

LPL201-RD P188



LPL149 P192



LPL150 P192



LPL151 P192

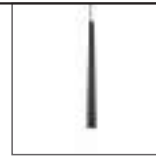

LPL264-BK P194

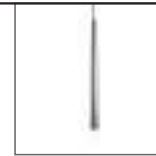

LPL264-CR P194

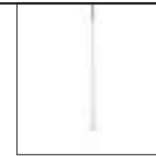

LPL264-WT P194



LPL226-BK P195

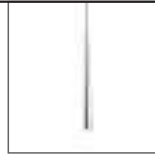

LPL226-CR P195

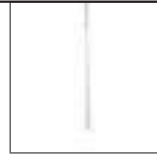

LPL226-WT P195



LPL274-BK P198

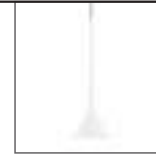

LPL274-WT P198



LPL152-BK P200

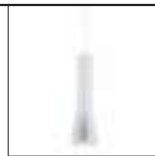

LPL152-WT P200



LPL153-BK P200

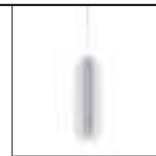

LPL153-WT P201



LPL154-BK P201



LPL155-BK P201



LPL155-WT P201

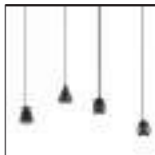

LPL286 SERIES P206

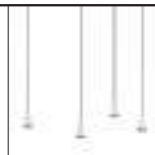

LPL286 SERIES P207



LPL268-BK P208

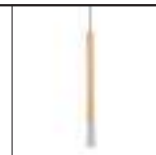

LPL268-CR P208

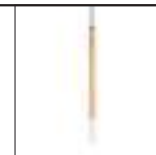

LPL268-WT P208



LPL262 P210



LPL263 P210



LPL190 P211



LPL191 P211



LPL119 P212



LPL120 P212



LPL185 P213

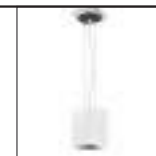

LPL186 P213



LPL165-BK P214



LPL165-WT P214



LPL165-CR P214

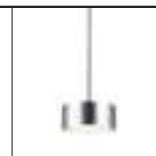

LPL165-SL P214



LPL165-GD P214

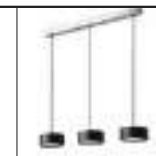

LPL166-BK P215

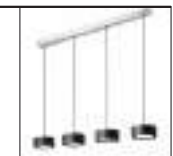

LPL167-BK P215

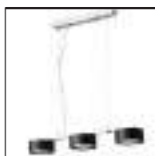

LPL168-BK P216

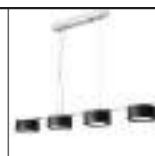

LPL169-BK P217



LPL170-BK P218



LPL187 P220

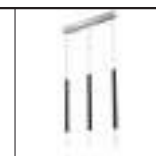

LPL188 P221



LPL176 P225

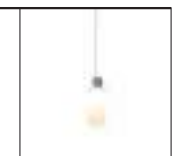

LPL174 P225



LPL236 P226



LPL237 P226



LPL238 P226



LPL239 P227



LPL271 P229



LPL272 P229



LPL273 P228

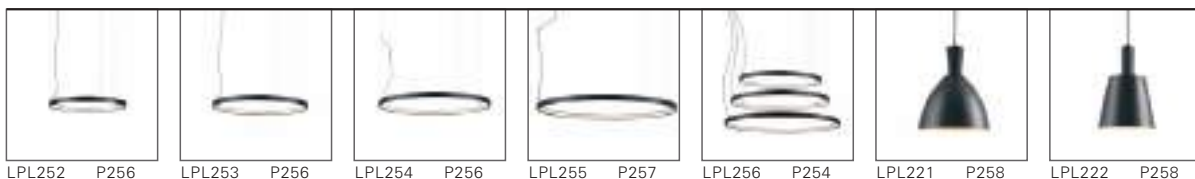
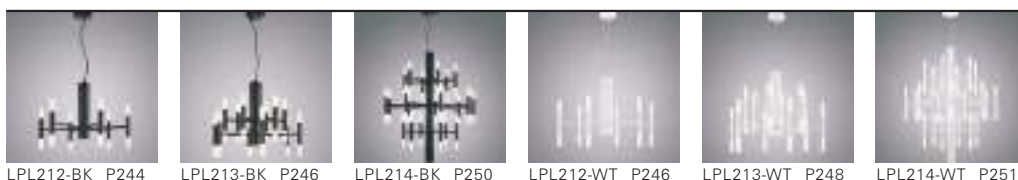

LED  
SURFACE  
DOWN  
LIGHTS





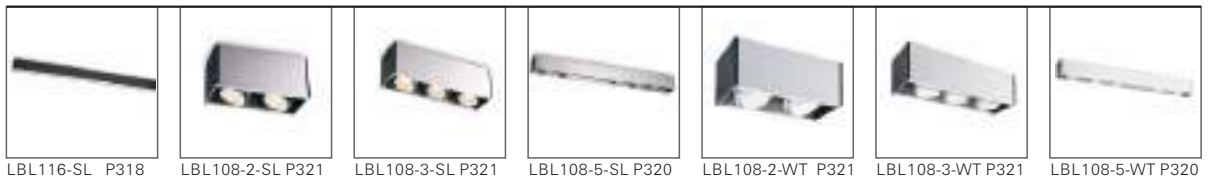
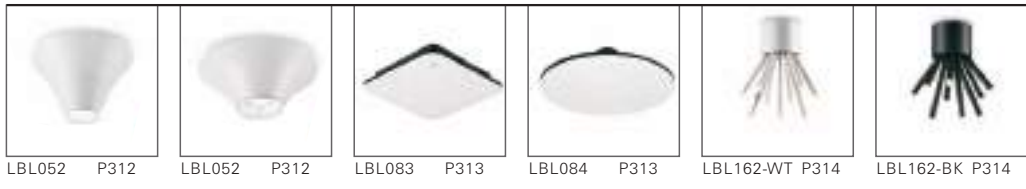

LED CHANDELIER





LBL217 P343    LBL218 P343    LBL165 P344    LBL166 P344    LPL241 P345    LPL242 P345



LBL231-WT P346    LBL231-GR P347    LBL148 P349    LBL149 P349    LBL146 P348    LBL147 P348



LBL151 P350    LBL150 P351    LBL152 P350    LBL153 P351    LBL155 P352    LBL154 P353    LBL156 P352

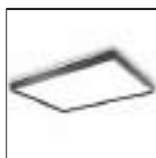

LBL157 P353

LED  
TABLE  
AND  
FLOOR  
LIGHTS

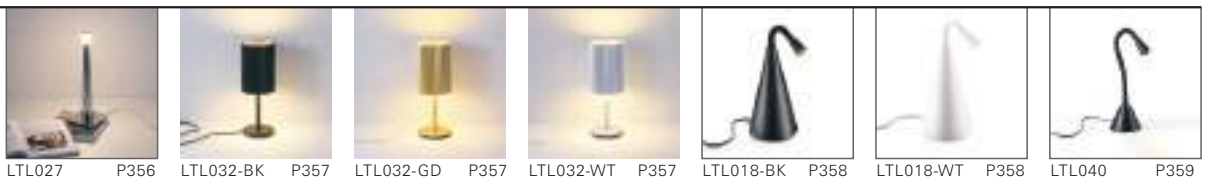

LTL027 P356    LTL032-BK P357    LTL032-GD P357    LTL032-WT P357    LTL018-BK P358    LTL018-WT P358    LTL040 P359



LTL029-CR P360    LTL030-CR P360    LTL031-CR P360    LTL029-BK P361    LTL030-BK P361    LTL031-BK P361

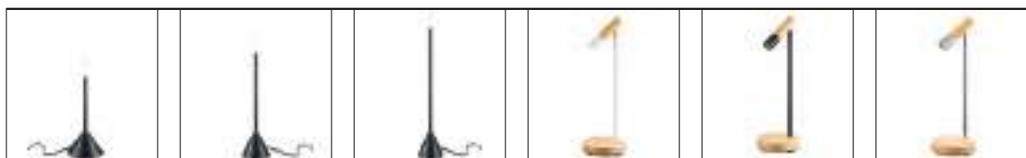

LTL022 P362    LTL023 P362    LTL024 P362    LTL038-WT P363    LTL038-BK P363    LTL038-CR P363

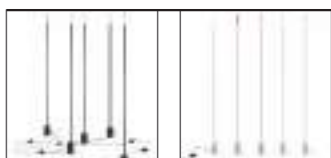

LFL019-BK P364    LFL019-WT P364

# INDEX

## OFFICE PART

### LED OFFICE PENDANT LIGHTS



LPL159-SL P368 LPL159-BK P368 LPL160-SL P370 LPL160-BK P370 LPL161-SL P371 LPL161-BK P371



LPL291-BK P372 LPL291-WT P372 LPL291-SL P373 LPL291-GD P373 LQL004-BK P374 LQL004-SL P374 LQL004-WT P374



LPL210 P376 LPL211 P376 LPL311-BK P377 LPL311-WT P377 LPL301 P378 LPL302-BK P379 LPL302-WT P379



LPL302-RD P380 LPL302-YW P380 LPL302-GN P380 LPL119 P382 LPL120 P382 LPL148 P383 LPL147 P383



LPL139-BK P384 LPL140-BK P385

### LED PANEL LIGHTS

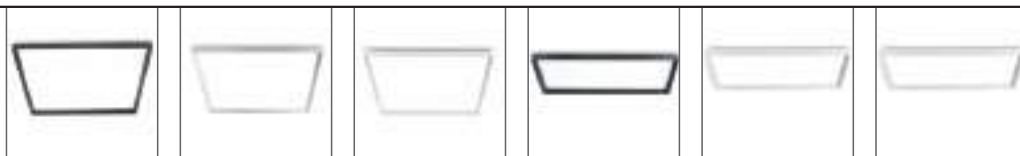

LQL001-BK P388 LQL001-WT P388 LQL001-SL P388 LQL002-BK P389 LQL002-WT P389 LQL002-SL P389



LQL013-WT P392 LQL014-WT P392 LQL011-WT P393 LQL011-SL P393 LQL012-WT P393 LQL012-SL P393

# INDEX

## ARCHITECTURE PART

LED  
SPOTLIGHT  
SURFACE  
MOUNT



LSP180-WT P396 LSP180-SL P396 LSP180-GD P396 LSP181-WT P398 LSP181-SL P398 LSP181-GD P398



LSP182-WT P399 LSP182-SL P399 LSP182-GD P399 LBL125 P400 LBL126 P400 LBL127 P400 LBL128 P400



LBL129 P401 LBL130 P401 LBL051 P402 LWA187-WT P402 LWA187-BK P402 LSP164 P403 LSP165-WT P404



LSP164-BK P403 LSP165-BK P404 LSP168 P405 LSP171 P405 LSP169 P406 LSP170 P406



LSP172 P407 LSP173 P407 LSP210 P408 LSP211 P408 LSP212 P408 LSP213 P408



LSP214 P409 LSP215 P409 LSP216 P409 LSP217 P409 LSP218 P410 LSP219 P410 LSP220 P411



LSP221 P411 LSP222 P412 LSP223 P412 LSP224 P413 LSP225 P413



LSP161 P414 LSP162 P414 LBL080 P415 LBL081 P415 LBL082 P415



LSP071 P416 LSP072 P416 LSP073 P416 LBL077 P417 LBL078 P417 LBL079 P417



LBL199 P418 LBL200 P418 LBL121 P419 LBL122 P419

LED TRACK LIGHTS



LSP177-WT P421 LSP177-SL P421 LSP177-GD P421 LSP178-WT P423 LSP178-SL P423 LSP178-GD P423



LSP179-WT P424 LSP179-SL P424 LSP179-GD P424 LSP190-WT P426 LSP190-BK P426 LSP190-SL P426



LSP176-WT P428 LSP176-SL P428 LSP176-BK P428 LSP117 P430 LSP122 P430 LSP115 P432



LSP118 P432 LSP119 P432 LSP120 P432 LSP121 P432 LSP151 P438 LSP152 P438



LSP103 P439 LSP104 P439 LSP105 P439 LSP106 P442 LSP108 P442 LSP110 P442



LSP111 P443 LSP112 P443 LSP113 P443 LSP166 P444 LSP167 P444 TR-LSP126-WT P446 TR-LSP127-WT P446

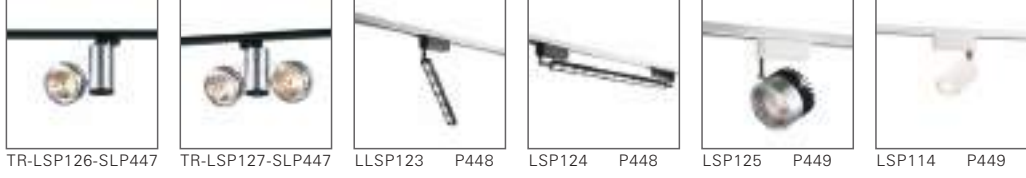

TR-LSP126-SLP447 TR-LSP127-SLP447 LLSP123 P448 LSP124 P448 LSP125 P449 LSP114 P449

LED  
SPOTLIGHT  
RECESSED



LDC880 SERIES P455



LDC880A SERIES P458



LDC001A-GD P461



LDC001A-BK P461



LDC001A-SL P461



LDC001A-WT P461



LDC992-BK P464



LDC992-GD P464



LDC992-SL P464



LDC992-WT P464



LDC993-BK P464



LDC993-GD P464



LDC993-SL P464



LDC993-WT P464



LDC994-SL P466



LDC995-SL P466



LDC996-SL P466



LDC997-SL P466



LDC994-WT P467



LDC995-WT P467



LDC996-WT P467



LDC997-WT P467



LDC926-WT P468



LDC927-WT P468



LDC928-WT P468



LDC926-SL P468



LDC927-SL P468



LDC928-SL P468



LDC926A-SL P470



LDC927A-SL P470



LDC928A-SL P470



LDC926A-WTP470



LDC927A-WTP470



LDC928A-W P470



LDC979B P472



LDC978B P472



LDC978A P472



LDC979A P472



LDC935A P474



LDC936A P474



LDC938A P474



LDC985 P476



LLDC984 P476



LDC988-WT P480



LDC989-WT P480



LDC990-WT P481



LDC991-WT P481



LDC988-BK P480



LDC989-BK P480



LDC990-BK P481



LDC991-BK P481



LDC988-GD P480



LDC989-GD P480



LDC990-GD P481



LDC991-GD P481



LDC207 P482



LDC207 P482



LDC207 P482



LDC339 P484

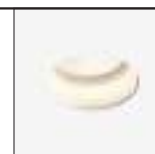

LLDC340 P484



LDC341 P484



LDC342 P485

LDC343 P485

LDC344 P485

LDC969 P486

LDC970 P486



LDC987-WT P487

LDC987-BK P487

LDC382 P488

LDC383 P488

LDC384 P488

LDC385 P488



LDC371 P489

LDC372 P489

LDC373 P489

LED  
GRILLE  
LIGHT  
RECESSED



LDC955 P492

LDC956 P492

LDC957 P492

LDC958 P493

LDC959 P493

LDC960 P493

LDC961 P494



LDC962 P494

LDC963 P494

LDC940 P496

LDC941 P496

LDC942 P496

LDC952 P498

LDC953 P498



LDC954 P498

LDC923 P501

LDC924 P501

LDC925 P501

LDC889 P504

LDC890 P504

LDC891 P504



LDC317 P506

LDC318 P506

LDC319 P506

LDC320 P507

LDC321 P507

LDC322 P507

LDC211 P508



LDC212 P508

LDC213 P508

LDC214 P510

LDC215 P510

LDC216 P510

LDC356 P512

LDC357 P422



LDC358 P512

LDC359 P514

LDC360 P514

LDC361 P514

LDC362 P515

LDC363 P515

LDC364 P515

LED  
DOWN  
LIGHT  
RECESSED

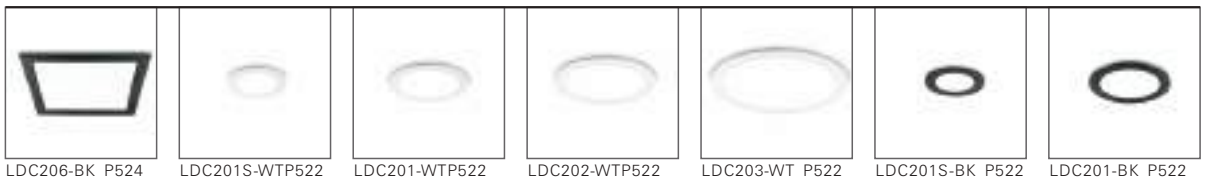
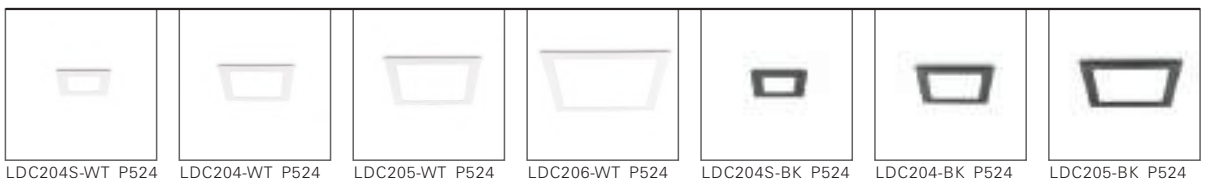

LED  
CABINET  
LIGHTS

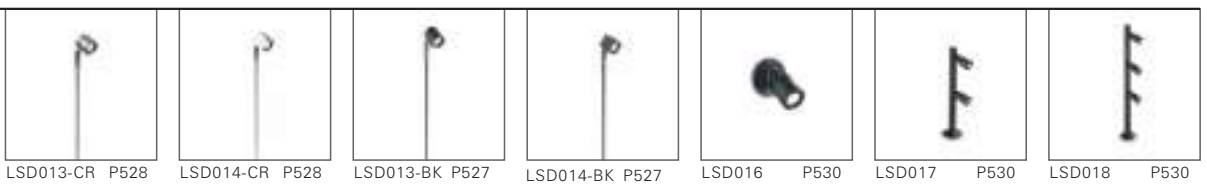



# INDEX

## OUTDOOR PARTS

LED  
OUTDOOR  
WALL  
LIGHTS

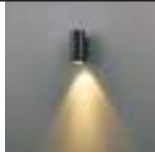

LWA215 P538

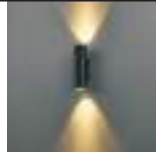

LWA216 P538



LWA253 P539



LWA254 P539



LWA217 P542

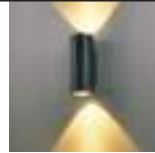

LWA218 P542



LWA256 P543



LWA258 P543

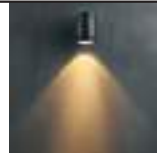

LWA173A P544

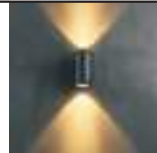

LWA174A P544



LWA250 P546



LWA251 P546

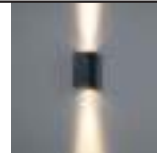

LWA248 P547



LWA249 P547

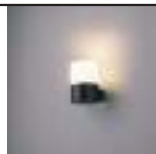

LWA213 P548



LWA214 P548



LWA210 P549

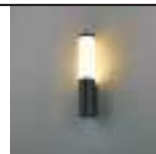

LWA211 P549

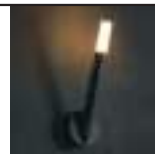

LWA135 P550



LWA139 P551

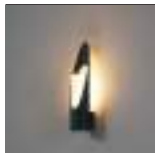

LWA310 P552



LWA311 P553



LWA312 P553

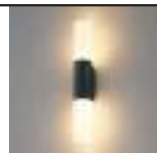

LWA291A P554



LWA292A P555



LWA293A P555



LWA300A-BKP557



LWA300B-BKP557



LWA300C-BKP556



LWA300D-BKP558



LWA300E-BKP558



LWA300F-BKP558



LWA300G-BKP560



LWA300H-BKP558



LWA300J-BKP560



LWA288-BK P562

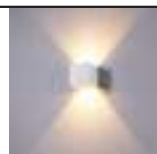

LWA288-WT P562



LWA279 P564



LWA280 P564



LWA281 P564

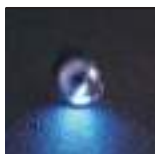

ODL007 P567

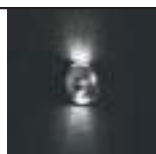

ODL008 P567

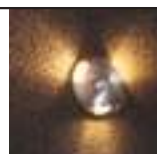

ODL009 P567

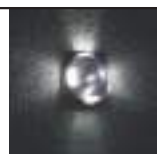

ODL010 P567



ODL025 P568

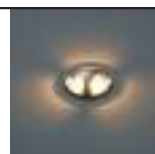

ODL026 P568

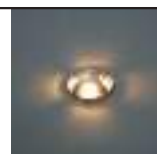

ODL027 P568



ODL043 P569

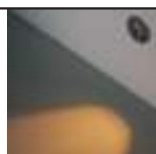

ODL042 P570

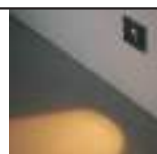

ODL041 P570

LED  
OUTDOOR  
INGROUND  
LIGHTS



ODL031 P573 ODL032 P573 ODL033 P573 ODL001 P576 ODL020 P576 ODL024 P576



ODL028 P580 ODL029 P580 ODL030 P580

LED  
OUTDOOR  
SPOT  
LIGHTS

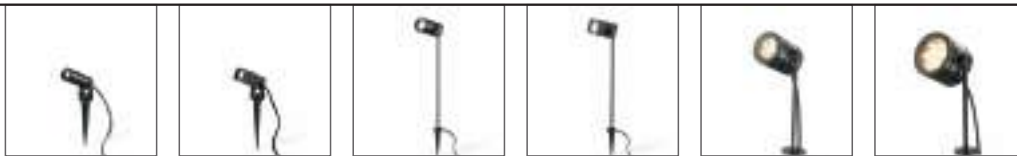

LSP183 P584 LSP187 P584 LFL027 P585 LFL028 P585 ODL035 P586 ODL036 P586



LSP155 P587 LSP156 P587 LSP157 P587 LSP184 P588 LSP185 P588 LSP186 P588



LSP188 P581 LSP189 P581

LED  
GARDEN  
PATH  
LIGHTS



LFL006 P591 LFL007 P591 LFL008 P591 LFL009 P592 LFL010 P592 LFL011 P592



LFL022 P595 LFL023 P595 LFL024 P595 LFL020 P594 LFL021 P594 LFL016 P597 LFL017 P597

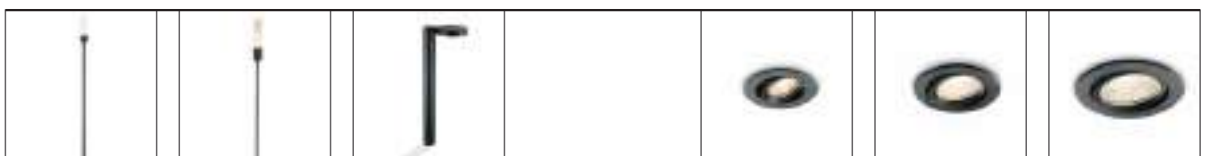

LFL018 P597 LFL015 P596 LFL026 P598 LDC335 P601 LDC336 P601 LDC337 P601



LBL183 P602 LBL184 P602 LBL185 P602 LBL186 P603 LBL187 P603 LBL188 P603

LED  
TUBES  
STRIPS  
BULBS



INDEX

LAMP REPLACEABLE CASING

GU10  
LAMP  
CASING



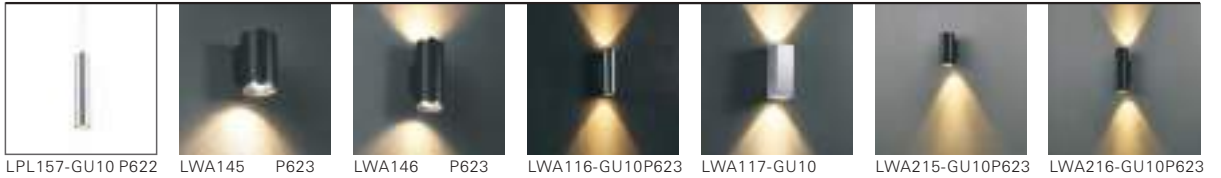

AR111  
LAMP  
CASING





LED

DECO-

RATIVE

WALL

LIGHTS





LIGHT  
BEGINS  
FROM  
DARKNESS





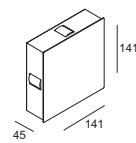

code **LWA161**

casing steel / white painting

lamping LED 4X1W / Ra>80 / 280LM

Beam 8 degree /

2700K/~~3000K~~/4000K/6000K

installation      IP20

surface customizable  black paint equal to RAL9011  
 concrete grey paint similar to RAL7037

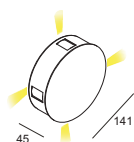

code **LWA158**  
 casing steel / white painting  
 lamping LED 4X1W / Ra>80 /280LM  
 Beam 8 degree /  
 2700K/3000K/4000K/6000K  
 installation      IP20

surface customizable  black paint equal to RAL9011  
 concrete grey paint similar to RAL7037

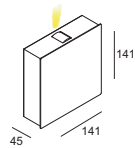

code **LWA159**  
 casing steel / white painting  
 lamping LED 1X1W / Ra>80 /70LM  
 Beam 8 degree /  
 2700K/3000K/4000K/6000K  
 installation     IP20

surface customizable  black paint equal to RAL9011  
 concrete grey paint similar to RAL7037

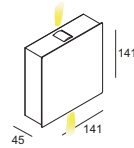





code **LWA160**  
 casing steel / white painting  
 lamping LED 2X1W / Ra>80 /140LM  
 Beam 8 degree /  
 2700K/3000K/4000K/6000K  
 installation     IP20

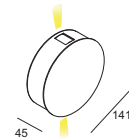



surface customizable  black paint equal to RAL9011  
 concrete grey paint similar to RAL7037



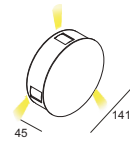

code **LWA 156**  
 casing steel / white painting  
 lamping LED 2X1W / Ra>80 / 140LM  
 Beam 8 degree /  
 2700K/**3000K**/4000K/6000K  
 installation     IP20



code **LWA 157**  
 casing steel / white painting  
 lamping LED 3X1W / Ra>80 / 210LM  
 Beam 8 degree /  
 2700K/**3000K**/4000K/6000K  
 installation     IP20

surface customizable  black paint equal to RAL9011  
 concrete grey point similar to RAL7037

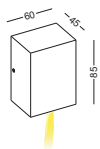

code **LWA166**

casing steel / white painting

lamping LED 1W / Ra>80 / 70LM

Beam 8 degree /

2700K/3000K/4000K/6000K

installation     IP20

surface customizable  black paint equal to RAL9011  
 concrete grey paint similar to RAL7037



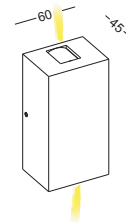
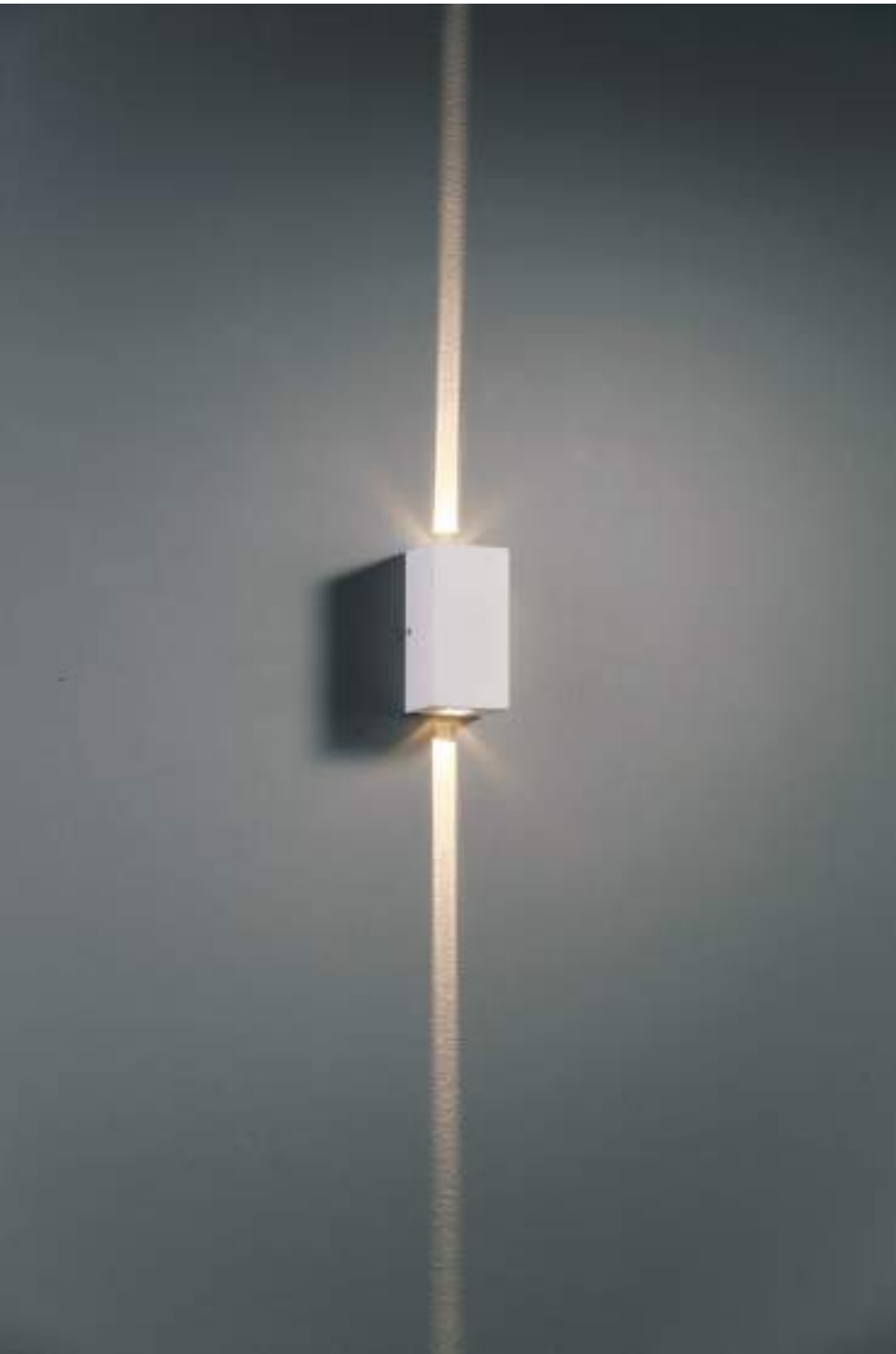

code **LWA167**

casing steel / white painting

lamping LED 2x1W / Ra>80 / 140LM

Beam 8 degree /



2700K/3000K/4000K/6000K

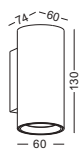
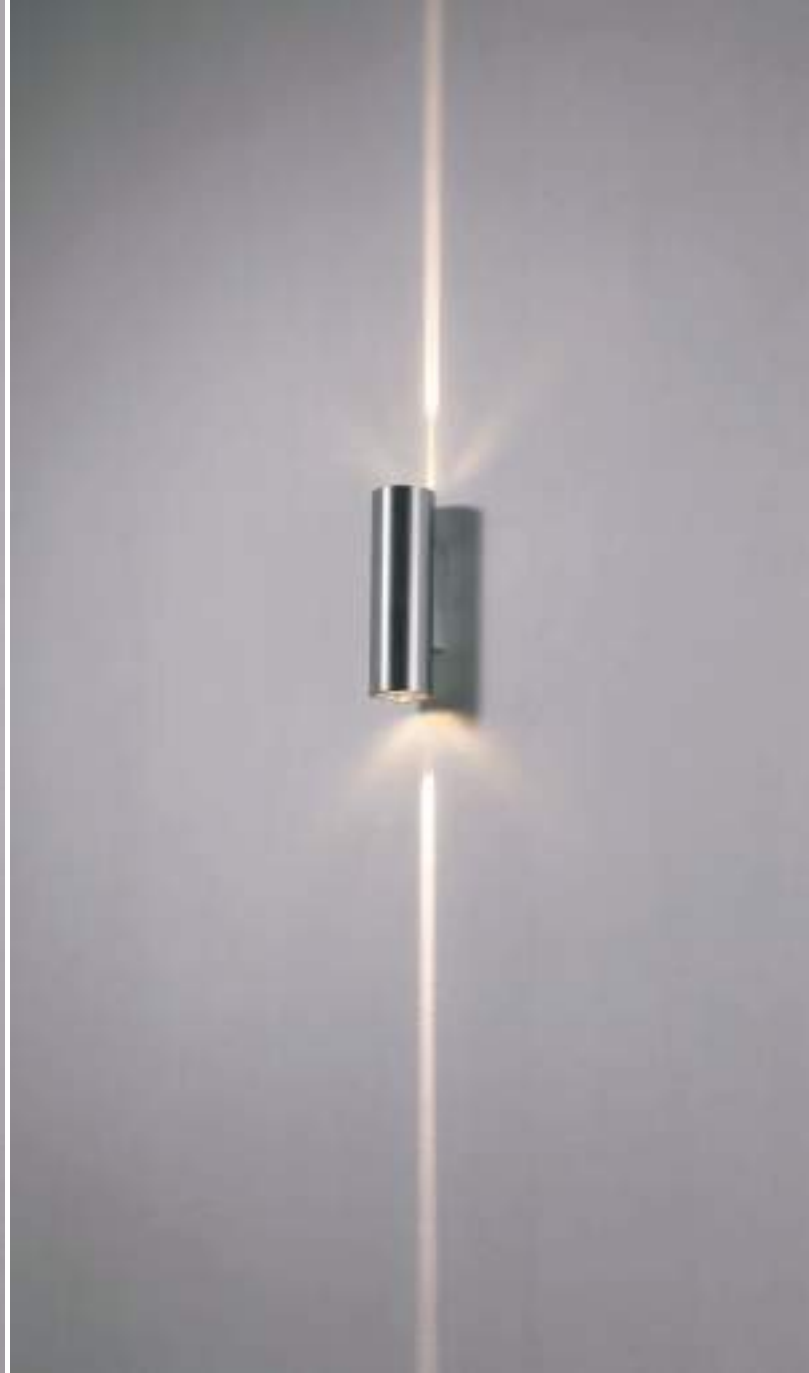

installation     IP20

surface customizable  black paint equal to RAL9011

 concrete grey paint similar to RAL7037



code **LWA276-SL**  
 casing Aluminium / anodized silver  
 lamping LED 3W / Ra>80 / 120LM  
 Beam 8 degree /  
 2700K/**3000K**/4000K/6000K  
 installation   **CE**  **IP20**

surface customizable  black paint equal to RAL9011  
 white paint similar to RAL9003  
 concrete grey paint similar to RAL7037



code **LWA277-SL**  
 casing Aluminium / anodized silver  
 lamping LED 2x3W / Ra>80 / 240LM  
 Beam 8 degree up/ 8 degree down  
 2700K/**3000K**/4000K/6000K  
 installation   **CE**  **IP20**

surface customizable  black paint equal to RAL9011  
 white paint similar to RAL9003  
 concrete grey paint similar to RAL7037



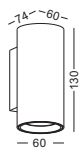

code **LWA276-BK**  
 casing Aluminium / anodized black  
 lamping LED 3W / Ra>80 / 120LM  
 Beam 8 degree /  
 2700K/~~3000K~~/4000K/6000K  
 installation IP20





surface customizable white paint similar to RAL9003  
 concrete grey paint similar to RAL7037

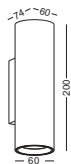

code **LWA277-BK**  
 casing Aluminium / anodized black  
 lamping LED 2x3W / Ra>80 / 240LM  
 Beam 8 degree up/ 8 degree down  
 2700K/~~3000K~~/4000K/6000K  
 installation IP20

surface customizable white paint similar to RAL9003  
 concrete grey paint similar to RAL7037



code **LWA278-SL**  
 casing Aluminium / anodized silver  
 lamping up LED 3W / Ra>80 / 120LM  
 down cob 6W / Ra>90 / 440lm  
 Beam 8 degree up / 38 degree down  
 2700K / ~~3000K~~ / 4000K / 6000K  
 installation     IP20

code **LWA278-BK**  
 casing Aluminium / anodized black

surface  
 customizable

-  black paint  
equal to RAL9011
-  white paint  
similar to RAL9003
-  concrete grey paint  
similar to RAL7037



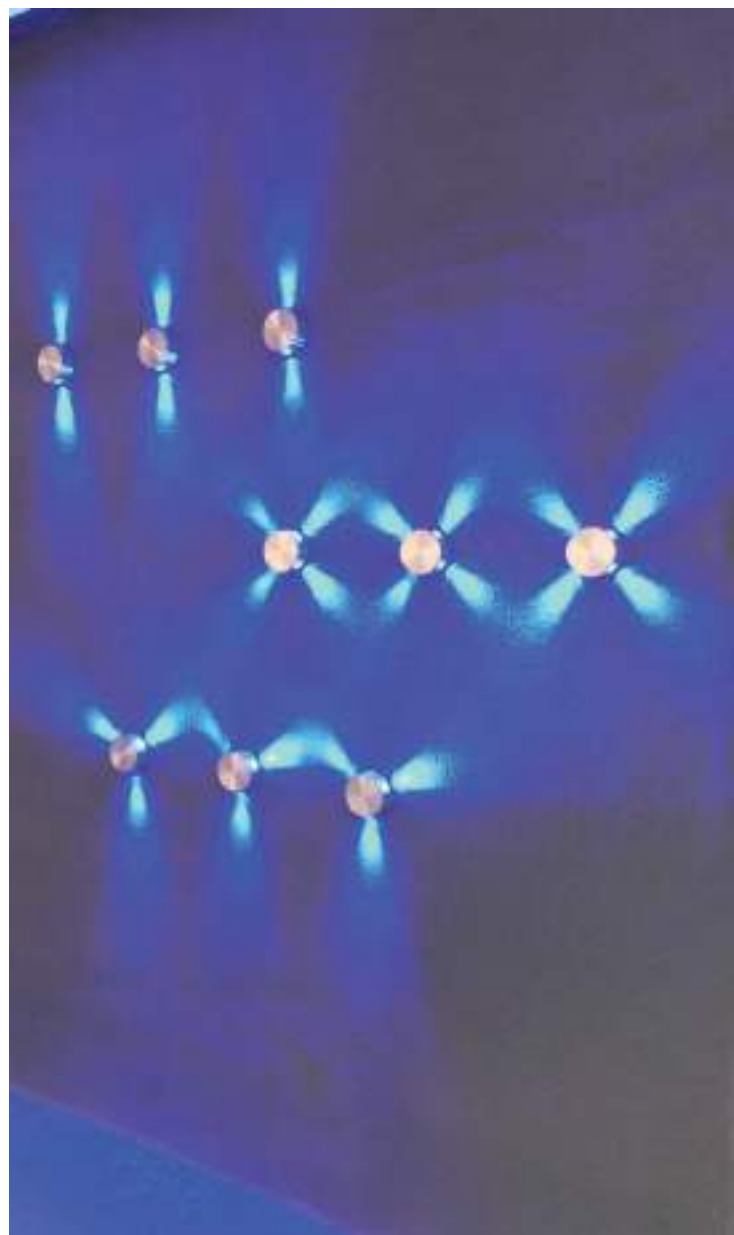

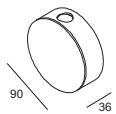

code **LWA027**  
 casing Aluminium / anodized silver  
 lamping LED 2x1W / Ra>80 /140LM  
 Beam 30 degree /  
 2700K/3000K/4000K/6000K  
 / red / green /blue

installation IP20

surface customizable black paint equal to RAL9011  
 white paint similar to RAL9003  
 concrete grey paint similar to RAL7037

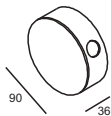

code **LWA028**  
 casing Aluminium / anodized silver  
 lamping LED 3x1W / Ra>80 /210LM  
 Beam 30 degree /  
 2700K/3000K/4000K/6000K  
 / red / green /blue

installation IP20

surface customizable black paint equal to RAL9011  
 white paint similar to RAL9003  
 concrete grey paint similar to RAL7037

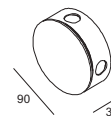

code **LWA029**  
 casing Aluminium / anodized silver  
 lamping LED 4x1W / Ra>80 /280LM  
 Beam 30 degree /  
 2700K/3000K/4000K/6000K  
 / red / green /blue

installation IP20

surface customizable black paint equal to RAL9011  
 white paint similar to RAL9003  
 concrete grey paint similar to RAL7037

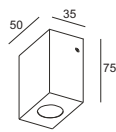

code **HL025/1**

casing aluminum / anodized silver

lamping LED 1W / Ra>80 / 70LM



Beam 10 degree /

2700K/~~3000K~~/4000K/6000K

red / green /blue

installation     IP20

surface customizable

-  black paint equal to RAL9011
-  white paint similar to RAL9003
-  concrete grey paint similar to RAL7037

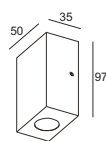
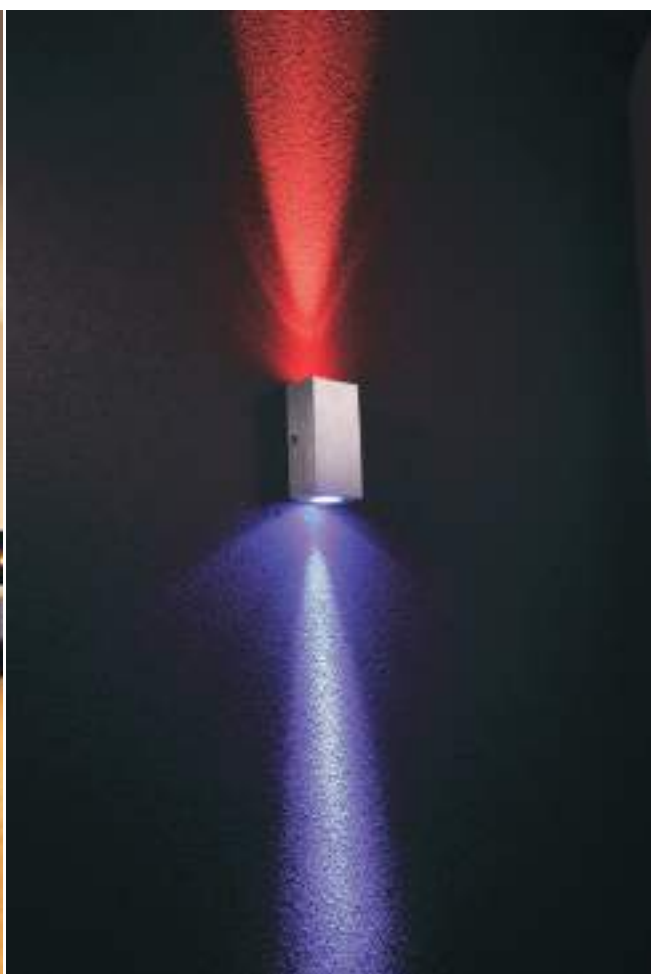



code **HL025/2**  
 casing aluminum / anodized silver  
 lamping LED 2x1W / Ra>80 / 140LM  
 Beam 10 degree /  
 2700K/3000K/4000K/6000K  
 red / green / blue  
 installation          IP20

surface customizable

- black paint equal to RAL9011
- white paint similar to RAL9003
- concrete grey paint similar to RAL7037



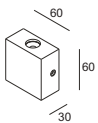

code **LWA071**  
 casing aluminum / anodized silver  
 lamping LED 1W / Ra>80 / 70LM  
 Beam 30 degree /  
 2700K/3000K/4000K/6000K  
 red / green /blue  
 installation    IP20

surface customizable  black paint equal to RAL9011  
 white paint similar to RAL9003  
 concrete grey paint similar to RAL7037



code **LWA072**  
 casing aluminum / anodized silver  
 lamping LED 2X1W / Ra>80 / 140LM  
 Beam 30 degree /  
 2700K/3000K/4000K/6000K  
 red / green /blue  
 installation    IP20

surface customizable  black paint equal to RAL9011  
 white paint similar to RAL9003  
 concrete grey paint similar to RAL7037

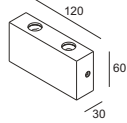

code **LWA073**  
 casing aluminum / anodized silver  
 lamping LED 3X1W / Ra>80 / 210LM  
 Beam 30 degree /  
 2700K/3000K/4000K/6000K  
 red / green /blue  
 installation    IP20

surface customizable  black paint equal to RAL9011  
 white paint similar to RAL9003  
 concrete grey paint similar to RAL7037

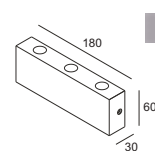



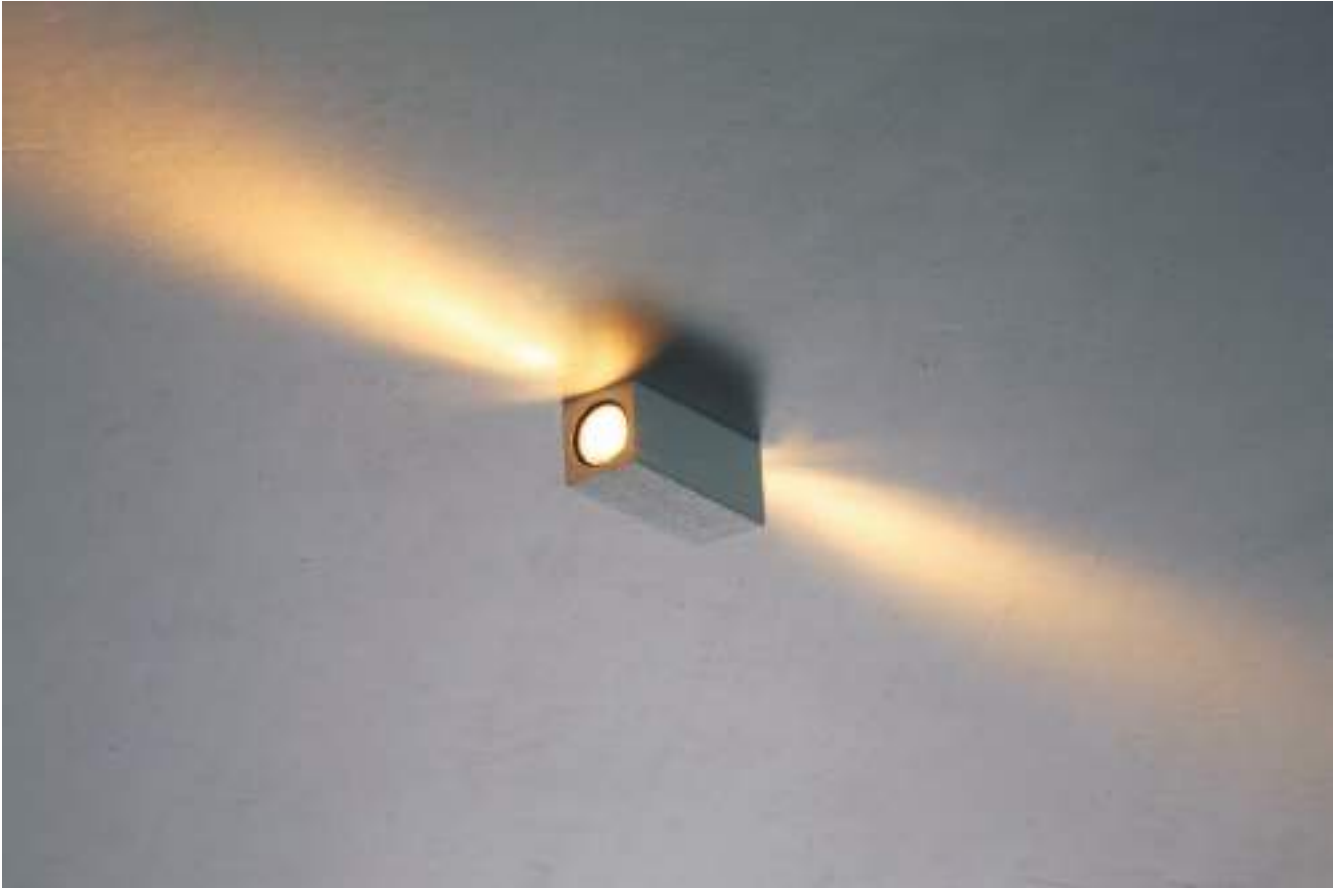

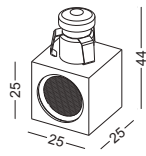

code **LDC908**  
 casing aluminum / white painting  
 lamping LED 1W / Ra>80 / 70LM  
 Beam 30 degree /  
 2700K/3000K/4000K/6000K  
 red / green /blue  
 installation  **IP20**  
 Dia 20mm

surface customizable  black paint equal to RAL9011  
 concrete grey paint similar to RAL7037

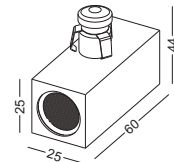

code **LDC909**  
 casing aluminum / white painting  
 lamping LED 2x1W / Ra>80 / 140LM  
 Beam 30 degree /  
 2700K/3000K/4000K/6000K  
 red / green /blue  
 installation  **IP20**  
 Dia 20mm

surface customizable  black paint equal to RAL9011  
 concrete grey paint similar to RAL7037



code **HL8022L**  
 casing aluminum / anodized silver  
 lamping LED 5W / Ra>90 / 430LM  
 Beam glass cover  
 2700K/3000K/4000K/6000K  
 installation      IP20

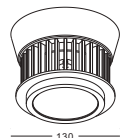

code **HL8004L**  
 casing aluminum / anodized silver  
 lamping LED 5W / Ra>90 / 430LM  
 Beam glass cover  
 2700K/3000K/4000K/6000K  
 installation      IP20



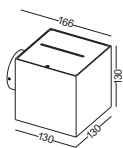
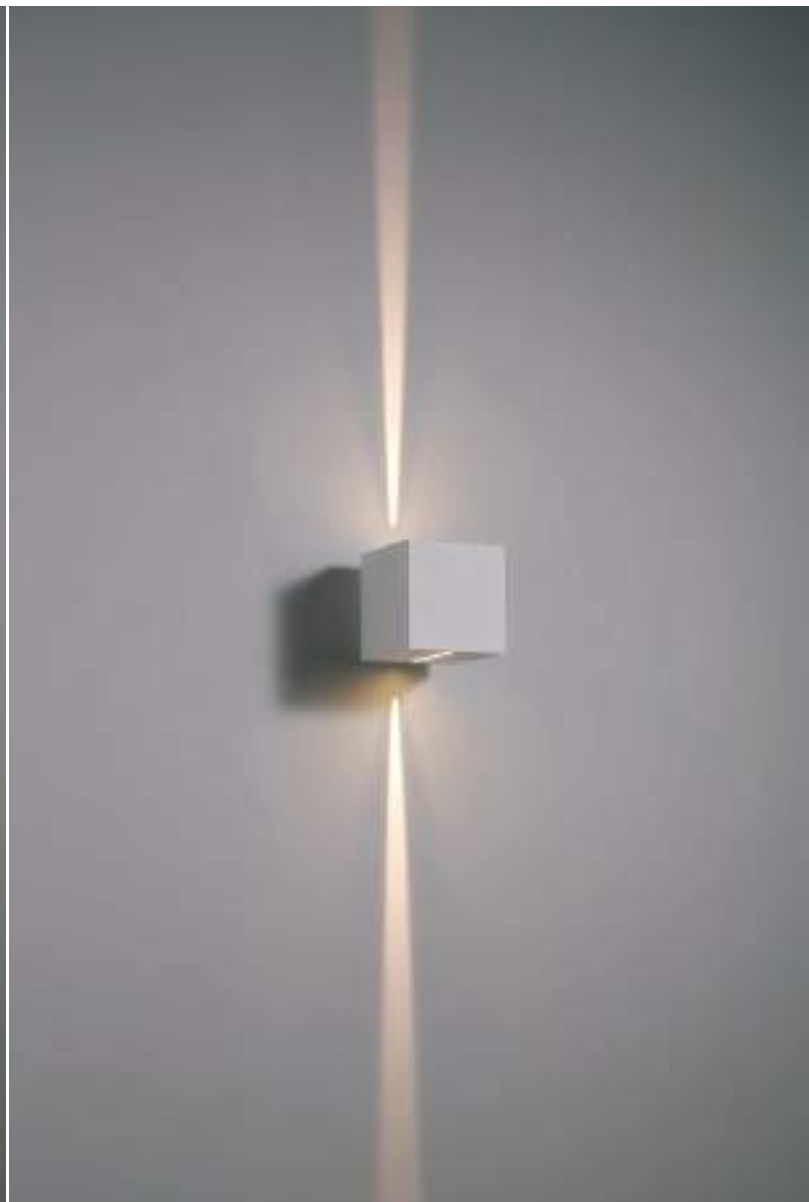

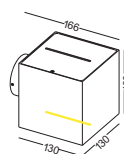

code **LWA300A-WT**  
 casing aluminum / white paint  
 lamping LED 3W / Ra>80 / 300LM  
 Beam 8 degree /  
 2700K/3000K/4000K/6000K  
 installation     IP65

surface customizable  black paint equal to RAL9011  
 concrete grey paint similar to RAL7037



code **LWA300B-WT**  
 casing aluminum / white paint  
 lamping LED 6W / Ra>80 / 600LM  
 Beam 8 degree /  
 2700K/3000K/4000K/6000K  
 installation     IP65

surface customizable  black paint equal to RAL9011  
 concrete grey paint similar to RAL7037

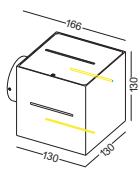

code **LWA300C-WT**

casing aluminum / white paint

lampping LED 12W / Ra>80 / 1200LM

Beam 8 degree /

2700K/~~3000K~~/4000K/6000K

installation     IP65

surface customizable  black paint equal to RAL9011

 concrete grey paint similar to RAL7037



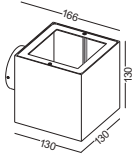

code **LWA300D-WT**  
casing aluminum / white paint  
lamping LED 6W / Ra>90 / 500LM  
Beam 80 degree /  
2700K/**3000K**/4000K/6000K  
installation IP65

surface customizable black paint equal to RAL9011  
 concrete grey paint similar to RAL7037

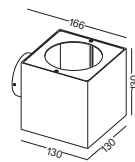

code **LWA300E-WT**  
casing aluminum / white paint  
lamping LED 6W / Ra>90 / 500LM  
Beam 90 degree /  
2700K/**3000K**/4000K/6000K  
installation IP65



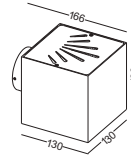

surface customizable black paint equal to RAL9011  
 concrete grey paint similar to RAL7037

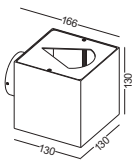

code **LWA300G-WT**  
 casing aluminum / white paint  
 lamping LED 6W / Ra>90 /500LM  
 Beam decorative/  
 2700K/**3000K**/4000K/6000K  
 installation     IP65

surface customizable  black paint equal to RAL9011  
 concrete grey paint similar to RAL7037



code **LWA300F-WT**  
 casing aluminum / white paint  
 lamping LED 6W / Ra>90 /500LM  
 Beam 60 degree /  
 2700K/**3000K**/4000K/6000K  
 installation     IP65

surface customizable  black paint equal to RAL9011  
 concrete grey paint similar to RAL7037





code **LWA300H-WT**

casing aluminum / white paint

lampping LED 6W / Ra>90 / 500LM

Beam 60 degree up / 8 degree down  
2700K/3000K/4000K/6000K

installation     IP65

surface customizable  black paint equal to RAL9011

 concrete grey paint similar to RAL7037

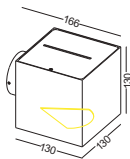

code **LWA300J-WT**

casing aluminum / white paint

lampping LED 6W / Ra>90 / 500LM

Beam 80 degree up / 8 degree down  
2700K/3000K/4000K/6000K

installation     IP65

surface customizable  black paint equal to RAL9011

 concrete grey paint similar to RAL7037

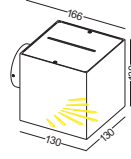









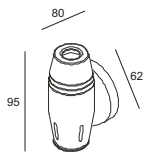

LED  
WALL  
LIGHTS  
SURFACE  
MOUNT









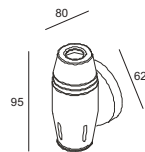

code **LWA051**  
 casing aluminium / anodized silver  
 lamping LED 1W / Ra>80 / 70LM  
 Beam 45 degree /  
 2700K/3000K/4000K/6000K  
 installation     IP20





surface customizable  black paint equal to RAL9011  
 white paint similar to RAL9003  
 concrete grey paint similar to RAL7037

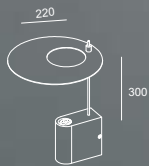

code **LWA052**  
 casing aluminium / anodized silver  
 lamping LED 2W / Ra>80 / 140LM  
 Beam 45 degree /  
 2700K/3000K/4000K/6000K  
 installation     IP20

surface customizable  black paint equal to RAL9011  
 white paint similar to RAL9003  
 concrete grey paint similar to RAL7037



code LWA 106  
casing aluminium / anodized black  
lamping LED 3W / Ra>80 / 210LM  
Beam 30 degree /   
2700K/3000K/4000K/6000K  
installation     IP20





code **LWA 138**

casing aluminum lamp / black paint  
steel reflector / white paint

lampping LED 6W / Ra>80 / 420LM

Beam 60 degree /

2700K/3000K/4000K/6000K

installation     IP20

---

surface customizable  black paint  
equal to RAL9011

 white paint  
similar to RAL9003



 concrete grey paint  
similar to RAL7037

---

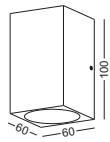
reflector installed seperately  
reflector angle adjustable



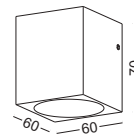

code **LWA 183**  
 casing aluminum / anodized silver  
 lamping LED 2W / Ra>80 / 140LM  
 Beam no lense /  
 2700K/3000K/4000K/6000K  
 installation     IP20

surface customizable  black paint equal to RAL9011  
 white paint similar to RAL9003  
 concrete grey paint similar to RAL7037



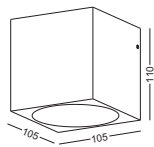

code **LWA 182**  
 casing aluminum / anodized silver  
 lamping LED 1W / Ra>80 / 70LM  
 Beam no lense /  
 2700K/3000K/4000K/6000K  
 installation     IP20

surface customizable  black paint equal to RAL9011  
 white paint similar to RAL9003  
 concrete grey paint similar to RAL7037



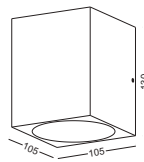

code **LWA184**  
 casing aluminum / anodized silver  
 lamping COB 5W / Ra>90 / 430LM  
 Beam no reflector /  
 2700K/3000K/4000K/6000K  
 installation     IP20

surface customizable  black paint equal to RAL9011  
 white paint similar to RAL9003  
 concrete grey paint similar to RAL7037



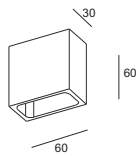

code **LWA185**  
 casing aluminum / anodized silver  
 lamping COB 10W / Ra>90 / 860LM  
 Beam no reflector /  
 2700K/3000K/4000K/6000K  
 installation     IP20

surface customizable  black paint equal to RAL9011  
 white paint similar to RAL9003  
 concrete grey paint similar to RAL7037



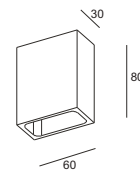

code **HL004/1**  
 casing aluminum / anodized silver  
 lamping LED 1W / Ra>80 / 70LM  
 Beam no lense / no cover  
 2700K/~~3000K~~/4000K/6000K  
 installation     IP20

surface customizable  black paint equal to RAL9011  
 white paint similar to RAL9003  
 concrete grey paint similar to RAL7037



code **HL004/2**  
 casing aluminum / anodized silver  
 lamping LED 2W / Ra>80 / 140LM  
 Beam no lense / no cover  
 2700K/~~3000K~~/4000K/6000K  
 installation     IP20

surface customizable  black paint equal to RAL9011  
 white paint similar to RAL9003  
 concrete grey paint similar to RAL7037







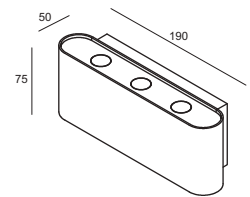
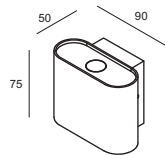
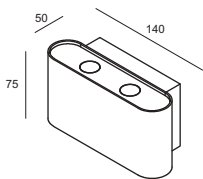

code **LWA103**

casing aluminum / anodized silver  
 lamping LED 4W / Ra>80 /280LM  
 Beam 30 degree /  
 2700K/~~3000K~~/4000K/6000K  
 installation IP20

surface customizable black paint equal to RAL9011  
 white paint similar to RAL9003  
 concrete grey paint similar to RAL7037

code **LWA101**

casing aluminum / anodized silver  
 lamping LED 2W / Ra>80 /140LM  
 Beam 30 degree /  
 2700K/~~3000K~~/4000K/6000K  
 installation IP20

surface customizable black paint equal to RAL9011  
 white paint similar to RAL9003  
 concrete grey paint similar to RAL7037

code **LWA105**

casing aluminum / anodized silver  
 lamping LED 6W / Ra>80 /420LM  
 Beam 30 degree /  
 2700K/~~3000K~~/4000K/6000K  
 installation IP20

surface customizable black paint equal to RAL9011  
 white paint similar to RAL9003  
 concrete grey paint similar to RAL7037



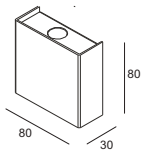

code **LWA022**  
 casing aluminum / white paint  
 lamping LED 2W / Ra>80 / 140LM  
 Beam 30 degree /  
 2700K/~~3000K~~/4000K/6000K  
 installation IP20

surface customizable black paint equal to RAL9011  
 concrete grey paint similar to RAL7037

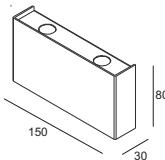

code **LWA024**  
 casing aluminum / white paint  
 lamping LED 4W / Ra>80 / 280LM  
 Beam 30 degree /  
 2700K/~~3000K~~/4000K/6000K  
 installation IP20

surface customizable black paint equal to RAL9011  
 concrete grey paint similar to RAL7037

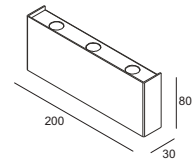

code **LWA026**  
 casing aluminum / white paint  
 lamping LED 6W / Ra>80 / 420LM  
 Beam 30 degree /  
 2700K/~~3000K~~/4000K/6000K  
 installation IP20



surface customizable black paint equal to RAL9011  
 concrete grey paint similar to RAL7037









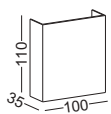

code **LWA165**  
 casing aluminum / anodized silver  
 lamping LED 6W / Ra>80 / 240LM  
 Beam no lense /  
 2700K/3000K/4000K/6000K  
 installation     IP20

surface customizable  black paint equal to RAL9011  
 white paint similar to RAL9003  
 concrete grey paint similar to RAL7037



code **LWA164**  
 casing aluminum / anodized silver  
 lamping LED 3W / Ra>80 / 120LM  
 Beam no lense /  
 2700K/3000K/4000K/6000K  
 installation     IP20

surface customizable  black paint equal to RAL9011  
 white paint similar to RAL9003  
 concrete grey paint similar to RAL7037

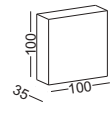



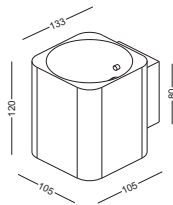

code **LWA270-SL**  
 casing aluminum / anodized silver  
 lamping COB 5W / Ra>90 / 430LM  
 Beam no lense / acrylic diffuser  
 2700K/~~3000K~~/4000K/6000K  
 installation IP20



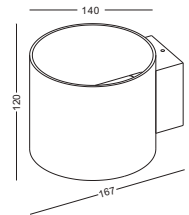

surface customizable black paint equal to RAL9011  
 white paint similar to RAL9003  
 concrete grey paint similar to RAL7037



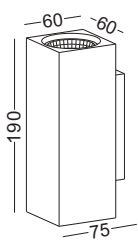

code **LWA269-SL**  
 casing aluminum / anodized silver  
 lamping COB 5W / Ra>90 / 430LM  
 Beam no lense / acrylic diffuser  
 2700K/~~3000K~~/4000K/6000K  
 installation IP20





surface customizable black paint equal to RAL9011  
 white paint similar to RAL9003  
 concrete grey paint similar to RAL7037



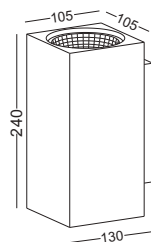

code **LWA117**  
 casing aluminum / anodized silver  
 lamping cob 2x5W / Ra>90 / 860LM  
 Beam 38 degree /  
 2700K/3000K/4000K/6000K  
 installation     IP20

surface customizable  black paint equal to RAL9011  
 white paint similar to RAL9003  
 concrete grey paint similar to RAL7037



code **LWA119**  
 casing aluminum / anodized silver  
 lamping cob 2x12W / Ra>90 / 1800LM  
 Beam 38 degree /  
 2700K/3000K/4000K/6000K  
 installation     IP20

surface customizable  black paint equal to RAL9011  
 white paint similar to RAL9003  
 concrete grey paint similar to RAL7037







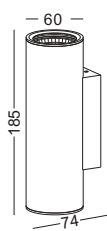

code **LWA116**  
 casing aluminum / anodized silver  
 lamping cob 2x5W / Ra>90 / 860LM  
 Beam 38 degree /  
 2700K/3000K/4000K/6000K  
 installation IP20

---

surface customizable black paint equal to RAL9011  
 white paint similar to RAL9003  
 concrete grey paint similar to RAL7037

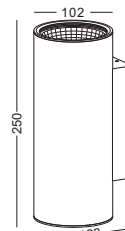





code **LWA118**  
 casing aluminum / anodized silver  
 lamping cob 2x12W / Ra>90 / 1800LM  
 Beam 38 degree /  
 2700K/3000K/4000K/6000K  
 installation IP20

---





surface customizable black paint equal to RAL9011  
 white paint similar to RAL9003  
 concrete grey paint similar to RAL7037

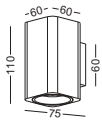

code **LWA264**  
 casing aluminum / white paint  
 lamping cob 5W / Ra>90 / 430LM  
 Beam 23 degree /  
 2700K/3000K/4000K/6000K  
 installation     IP20





surface customizable  black paint equal to RAL9011  
 concrete grey paint similar to RAL7037

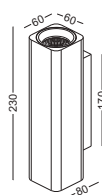

code **LWA265**  
 casing aluminum / white paint  
 lamping cob 2x6W / Ra>90 / 1000LM  
 Beam 23 degree /  
 2700K/3000K/4000K/6000K  
 installation     IP20

surface customizable  black paint equal to RAL9011  
 concrete grey paint similar to RAL7037





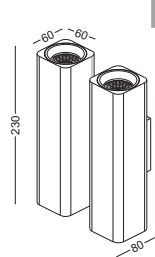

code **LWA266**  
 casing aluminum / white paint  
 lamping cob 4x6W / Ra>90 / 2000LM  
 Beam 23 degree /  
 2700K/3000K/4000K/6000K  
 installation     IP20

surface customizable  black paint equal to RAL9011  
 concrete grey paint similar to RAL7037









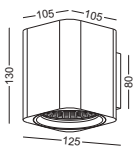

code **LWA267**  
 casing aluminum / white paint  
 lamping cob 12W / Ra>90 / 900LM  
 Beam 23 degree /  
 2700K/3000K/4000K/6000K  
 installation     IP20

surface customizable  black paint equal to RAL9011  
 concrete grey paint similar to RAL7037



code **LWA268**  
 casing aluminum / white paint  
 lamping cob 2x12W / Ra>90 / 1800LM  
 Beam 23 degree /  
 2700K/3000K/4000K/6000K  
 installation     IP20

surface customizable  black paint equal to RAL9011  
 concrete grey paint similar to RAL7037

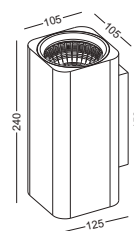

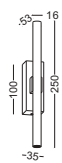
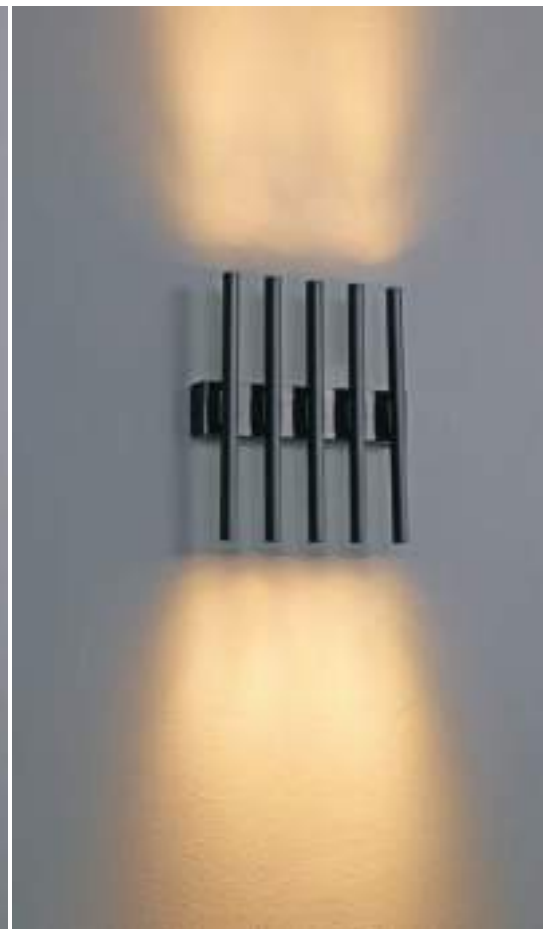

code **LWA226**

casing aluminum / anodized black  
 lamping LED 2x1W / Ra>80 / 140LM  
 Beam 30 degree /  
 2700K/3000K/4000K/6000K  
 installation IP20

surface customizable white paint similar to RAL9003  
 concrete grey paint similar to RAL7037

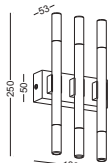

code **LWA241**

casing aluminum / anodized black  
 lamping LED 6x1W / Ra>80 / 280LM  
 Beam Acrylic diffuser /  
 2700K/3000K/4000K/6000K  
 installation IP20

surface customizable white paint similar to RAL9003  
 concrete grey paint similar to RAL7037

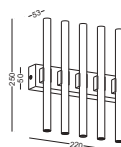

code **LWA240**

casing aluminum / anodized black  
 lamping LED 10x1W / Ra>80 / 700LM  
 Beam 30 degree /  
 2700K/3000K/4000K/6000K  
 installation IP20

surface customizable white paint similar to RAL9003  
 concrete grey paint similar to RAL7037

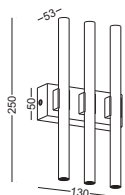

code **LWA239**

casing aluminum / anodized black  
 lamping LED 6x1W / Ra>80 / 420LM  
 Beam 30 degree /  
 2700K/3000K/4000K/6000K  
 installation IP20

surface customizable white paint similar to RAL9003  
 concrete grey paint similar to RAL7037

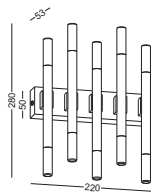

code **LWA242**

casing aluminum / anodized black  
 lamping LED 10x1W / Ra>80 / 700LM  
 Beam Acrylic diffuser /  
 2700K/3000K/4000K/6000K  
 installation IP20

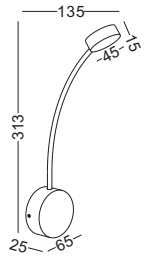

surface customizable white paint similar to RAL9003  
 concrete grey paint similar to RAL7037



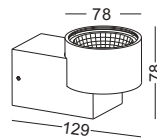

code **LWA137**  
 casing aluminum / white paint  
 lamping LED 3W / Ra>80 / 210LM  
 Beam indirect light  
 2700K/3000K/4000K/6000K  
 installation     IP20

surface customizable  black paint equal to RAL9011  
 concrete grey paint similar to RAL7037



code **LWA134**  
 casing aluminum / anodized silver  
 lamping COB 5W / Ra>90 / 430LM  
 Beam 38 degree /  
 2700K/3000K/4000K/6000K  
 installation     IP20

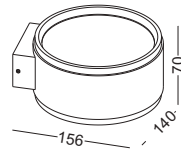

surface customizable  black paint equal to RAL9011  
 white paint similar to RAL9003  
 concrete grey paint similar to RAL7037



code **LWA115**  
 casing aluminum / white paint  
 lamping LED 8W / Ra>80 / 800LM  
 Beam indirect light  
 2700K/~~3000K~~/4000K/6000K  
 installation     IP20

surface customizable  black paint equal to RAL9011  
 concrete grey paint similar to RAL7037

code **HL8072/1**  
 casing aluminum / anodized silver  
 lamping cob 5W / Ra>90 / 430LM  
 Beam white glass shade /  
 2700K/~~3000K~~/4000K/6000K  
 installation     IP20

surface customizable  black paint equal to RAL9011  
 white paint similar to RAL9003  
 concrete grey paint similar to RAL7037









code **LWA223**

casing aluminum / chrome plated

lamping led 6W / Ra>80 / 600LM

Beam light inside the ring /

2700K/3000K/4000K/6000K

installation     IP20

surface customizable

 black paint equal to RAL9011

 white paint similar to RAL9003

 concrete grey paint similar to RAL7037

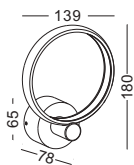

code **LWA222**

casing aluminum / chrome plated

lamping led 6W / Ra>80 / 600LM

Beam light inside the ring /

2700K/3000K/4000K/6000K

installation     IP20

surface customizable

 black paint equal to RAL9011

 white paint similar to RAL9003

 concrete grey paint similar to RAL7037

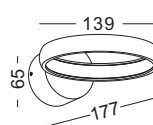



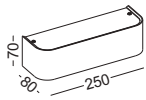

code **LWA149-WT**  
 casing aluminum / white paint  
 lamping LED 8W / Ra>80 / 800LM  
 Beam indirect light  
 2700K/~~3000K~~/4000K/6000K  
 installation IP20

surface customizable

- black paint equal to RAL9011
- concrete grey paint similar to RAL7037
- anodized silver brushed linear

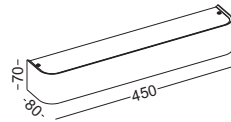

code **LWA150-WT**  
 casing aluminum / white paint  
 lamping LED 12W / Ra>80 / 1200LM  
 Beam indirect light  
 2700K/~~3000K~~/4000K/6000K  
 installation IP20

surface customizable

- black paint equal to RAL9011
- concrete grey paint similar to RAL7037
- anodized silver brushed linear

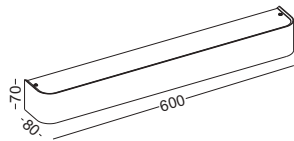

code **LWA151-WT**  
 casing aluminum / white paint  
 lamping LED 20W / Ra>80 / 1600LM  
 Beam indirect light  
 2700K/~~3000K~~/4000K/6000K  
 installation IP20

surface customizable

- black paint equal to RAL9011
- concrete grey paint similar to RAL7037
- anodized silver brushed linear

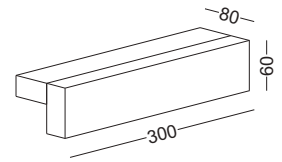

code **LWA141**  
 casing aluminum / white paint  
 lamping LED 4W / Ra>80 / 400LM  
 Beam indirect light  
 2700K/~~3000K~~/4000K/6000K  
 installation IP20



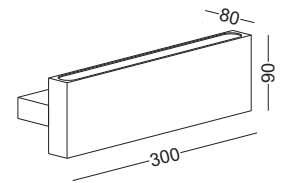

surface customizable black paint equal to RAL9011  
 concrete grey paint similar to RAL7037  
 anodized silver brushed linear



code **LWA142**  
 casing aluminum / white paint  
 lamping LED 8W / Ra>80 / 800LM  
 Beam indirect light  
 2700K/~~3000K~~/4000K/6000K  
 installation IP20

surface customizable black paint equal to RAL9011  
 concrete grey paint similar to RAL7037  
 anodized silver brushed linear



code **LWA221**  
casing Steel / white paint  
lamping LED 6W / Ra>80 / 600LM  
Beam indirect light  
2700K/**3000K**/4000K/6000K  
installation     IP20

surface  
customizable



 black paint  
equal to RAL9011

 concrete grey paint  
similar to RAL7037

 anodized silver  
brushed linear



code **LWA228A-BK**  
 casing Steel cover / black paint  
 lamping LED 4W / Ra>80 / 400LM  
 Beam acrylic diffuser  
 2700K/**3000K**/4000K/6000K  
 installation IP20

cover customizable aluminum cover in any color  
 consult with our sale manager stainless steel nickle/gold cover  
 other material other color

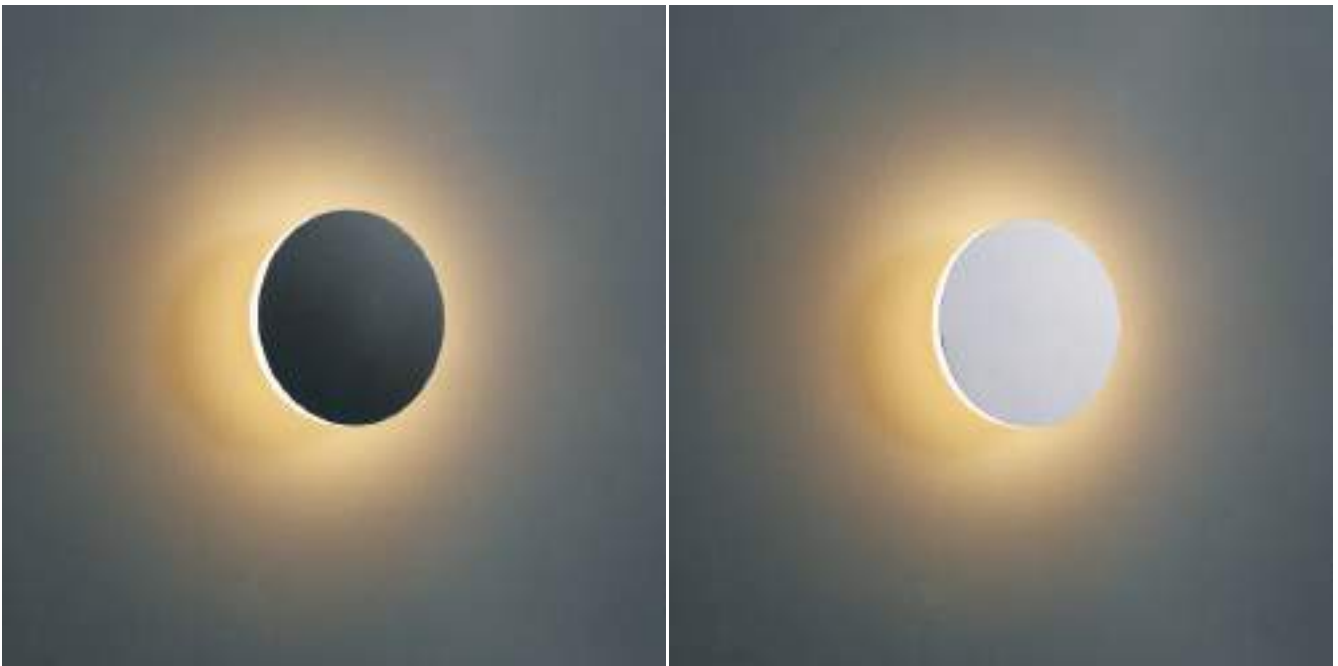

code **LWA228A-WT**  
 casing Steel cover / white paint  
 lamping LED 4W / Ra>80 / 400LM  
 Beam acrylic diffuser  
 2700K/**3000K**/4000K/6000K  
 installation IP20

cover customizable aluminum cover in any color  
 consult with our sale manager stainless steel nickle/gold cover  
 other material other color

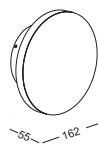

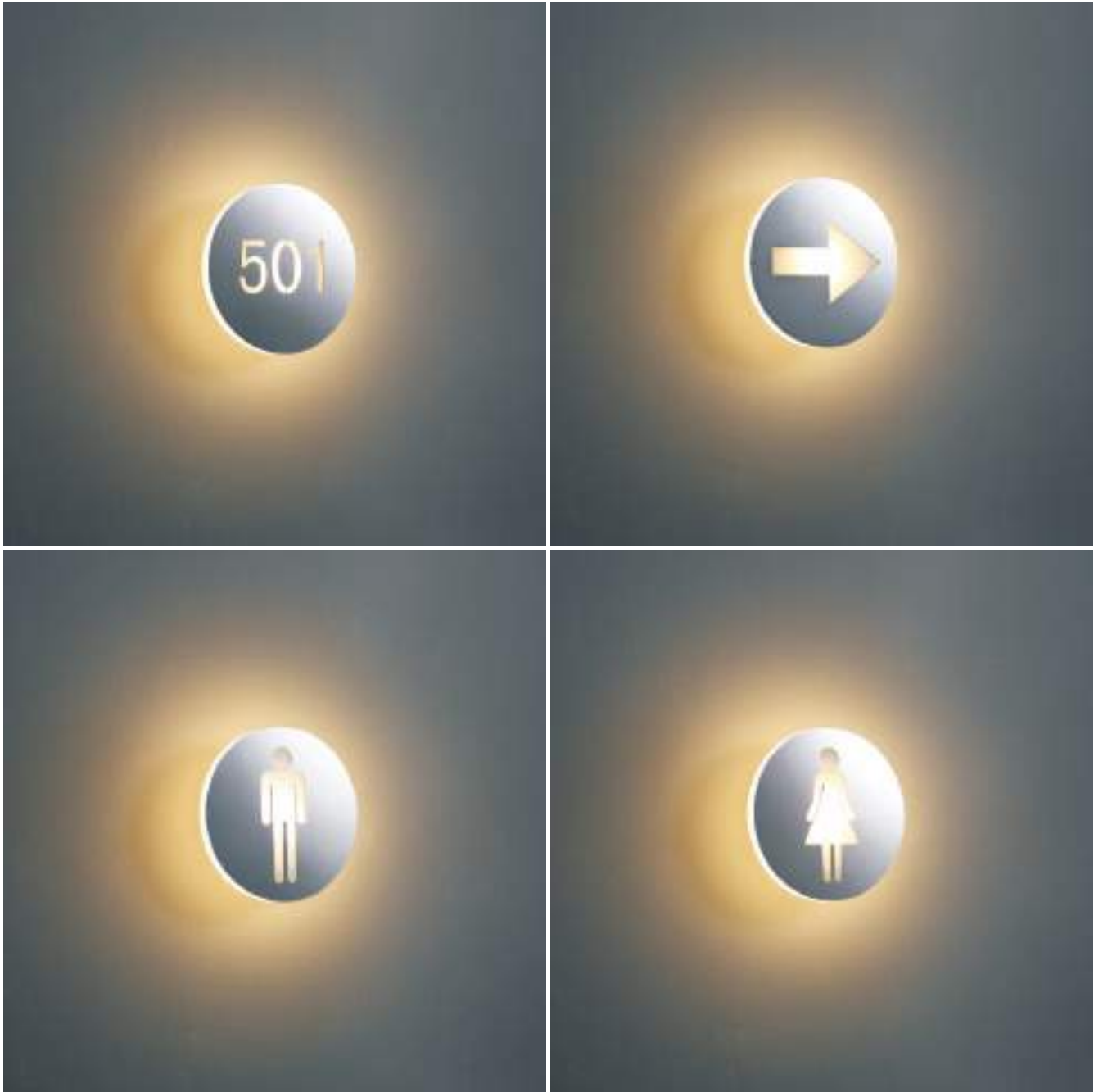

LWA228B



LWA228C



LWA228D



LWA228E

code **LWA228B/C/D/E**

casing nickle stainless steel cover

lamping LED 4W / Ra>80 /400LM

Beam acrylic diffuser

2700K/**3000K**/4000K/6000K

installation     IP20

cover customizable consult with our sale manager

cover material customizable  aluminum cover in any color

 stainless steel nickle/gold cover

cover can be laser cut with any number or any character



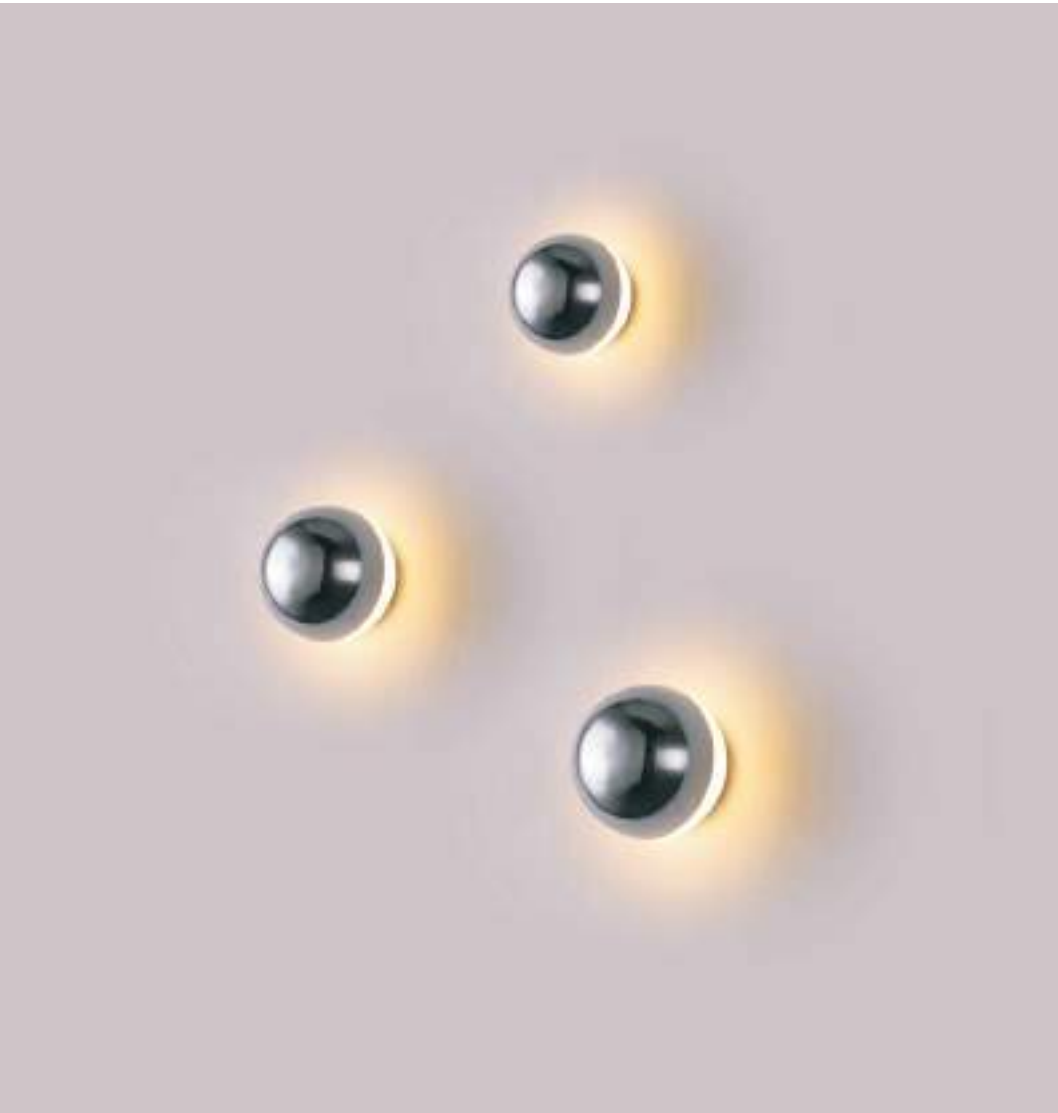







## LUNAR ECLIPSE

The idea of this series comes from the eclipse. The pure soft warm light comes out from the back of shiny chrome plated hemisphere, just like the lunar eclipse in the vast sky. The interesting is that we didn't make it a flat circle but a pure sphere, with half chrome plated steel hemisphere, and another half acrylic hemisphere as lighting diffuser. Of course there is a little aluminium part as the installation base, which you would not see when the whole lamp is installed.





The clever part of this design is that we put the power-supply and the led chips and also the heat sink in the plated hemisphere, so that the light can disperse as much as it can to the wall and as soft as it can be.



This series are very good decoration to the wall, no matter they are lighted on or off. The sphere is solid and it is objective and beautiful no matter from which angle you have seen it. You can put two or three sizes in the same wall, and a group of three or five lamps can give the wall amazing effects.

code **LWA282**  
 casing Steel / chrome plated  
 lamping LED 4W / Ra>80 /400LM  
 Beam acrylic diffuser  
 2700K/~~3000K~~/4000K/6000K  
 installation     IP20





surface customizable  black paint equal to RAL9011  
 concrete grey paint similar to RAL7037  
 white paint similar to RAL9003





code **LWA283**  
 casing Steel / chrome plated  
 lamping LED 4W / Ra>80 /400LM  
 Beam acrylic diffuser  
 2700K/~~3000K~~/4000K/6000K  
 installation     IP20

surface customizable  black paint equal to RAL9011  
 concrete grey paint similar to RAL7037  
 white paint similar to RAL9003



code **LWA284**  
 casing Steel / chrome plated  
 lamping LED 6W / Ra>80 /600LM  
 Beam acrylic diffuser  
 2700K/~~3000K~~/4000K/6000K  
 installation     IP20

surface customizable  black paint equal to RAL9011  
 concrete grey paint similar to RAL7037  
 white paint similar to RAL9003









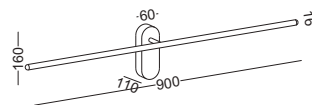





code **LWA244**  
 casing aluminum / anodized black  
 lamping LED 10W / Ra>80 / 1000LM  
 Beam indirect light  
 2700K/~~3000K~~/4000K/6000K  
 installation     IP20  90°

surface customizable

-  white paint similar to RAL9003
-  concrete grey paint similar to RAL7037
-  anodized silver brushed linear



code **LWA302**  
 casing aluminum / chrome plated  
 lamping LED 3W / Ra>80 / 300LM  
 Beam indirect light / acrylic diffuser  
 2700K/~~3000K~~/4000K/6000K  
 installation IP20

surface customizable black paint equal to RAL9011  
 white paint similar to RAL9003  
 concrete grey paint similar to RAL7037

code **LWA303**  
 casing aluminum / chrome plated  
 lamping LED 4W / Ra>80 / 400LM  
 Beam indirect light / acrylic diffuser  
 2700K/~~3000K~~/4000K/6000K  
 installation IP20

surface customizable black paint equal to RAL9011  
 white paint similar to RAL9003  
 concrete grey paint similar to RAL7037



code **LWA304**  
 casing aluminum / chrome plated  
 lamping LED 6W / Ra>80 / 600LM  
 Beam indirect light / acrylic diffuser  
 2700K/~~3000K~~/4000K/6000K  
 installation IP20

surface customizable black paint equal to RAL9011  
 white paint similar to RAL9003  
 concrete grey paint similar to RAL7037









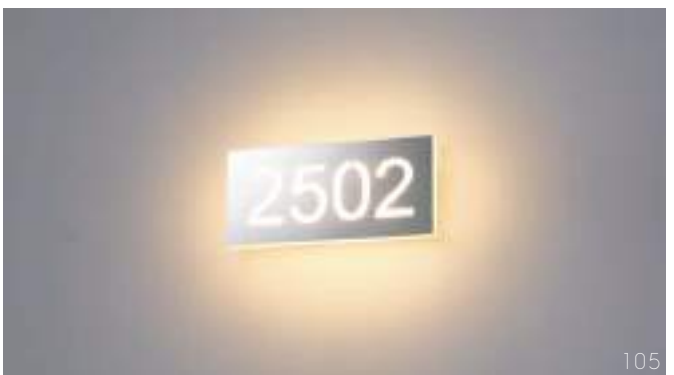
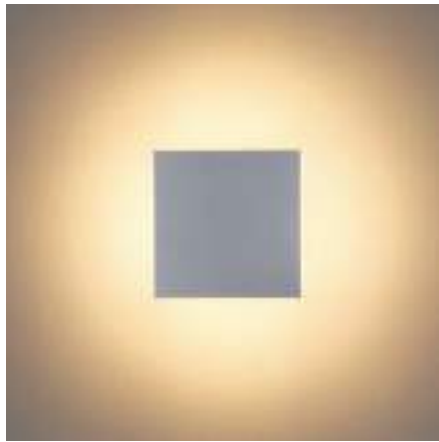
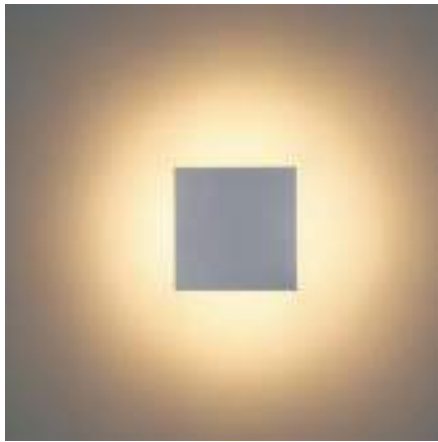
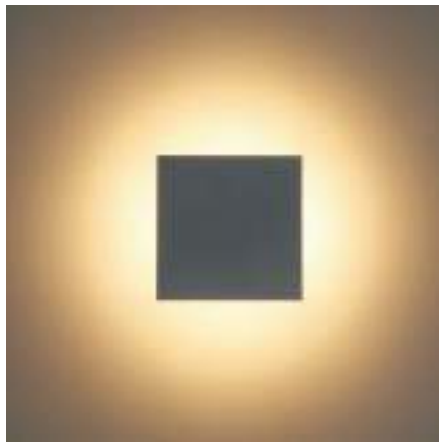
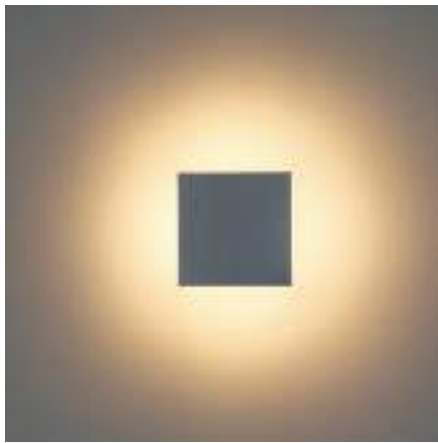
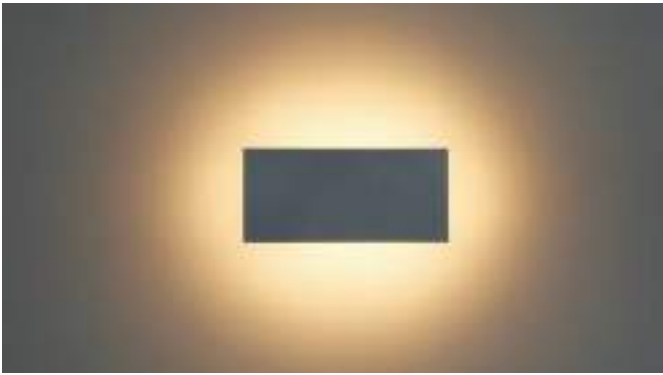

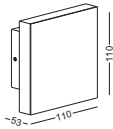

code **LWA295A-WT**  
**LWA295A-BK**

casing aluminum / steel cover / white paint / black paint

lampping LED 3W / Ra>80 /300LM

Beam indirect light / acrylic diffuser  
2700K/3000K/4000K/6000K

installation IP20

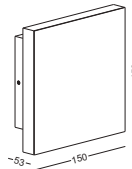

code **LWA296A-WT**  
**LWA296A-BK**

casing aluminum / steel cover / white paint / black paint

lampping LED 6W / Ra>80 /600LM

Beam indirect light / acrylic diffuser  
2700K/3000K/4000K/6000K

installation IP20

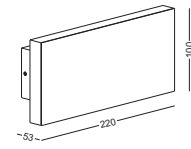

code **LWA294A-WT**  
**LWA294A-BK**

casing aluminum / steel cover / white paint / black paint

lampping LED 9W / Ra>80 /900LM

Beam indirect light / acrylic diffuser  
2700K/3000K/4000K/6000K

installation IP20

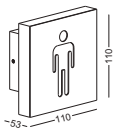

code **LWA295B**

casing aluminum base/white paint stainless steel cover / nickle

lampping LED 3W / Ra>80 /300LM

Beam indirect light / acrylic diffuser  
2700K/3000K/4000K/6000K

installation IP20

surface customizable material steel

- black paint equal to RAL9011
- white paint similar to RAL9003
- concrete grey paint similar to RAL7037

cover customized to be any drawing

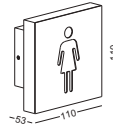

code **LWA295C**

casing aluminum base/white paint stainless steel cover / nickle

lampping LED 3W / Ra>80 /300LM

Beam indirect light / acrylic diffuser  
2700K/3000K/4000K/6000K

installation IP20

surface customizable material steel

- black paint equal to RAL9011
- white paint similar to RAL9003
- concrete grey paint similar to RAL7037

cover customized to be any drawing

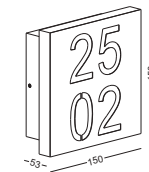

code **LWA296B**

casing aluminum base/white paint stainless steel cover / nickle

lampping LED 6W / Ra>80 /600LM

Beam indirect light / acrylic diffuser  
2700K/3000K/4000K/6000K

installation IP20

surface customizable material steel

- black paint equal to RAL9011
- white paint similar to RAL9003
- concrete grey paint similar to RAL7037

cover customized to be any drawing

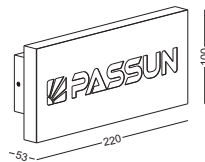

code **LWA294C**

casing aluminum base/white paint stainless steel cover / nickle

lampping LED 9W / Ra>80 /900LM

Beam indirect light / acrylic diffuser  
2700K/3000K/4000K/6000K

installation IP20

surface customizable material steel

- black paint equal to RAL9011
- white paint similar to RAL9003
- concrete grey paint similar to RAL7037

cover customized to be any drawing

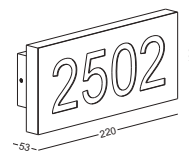

code **LWA294B**

casing aluminum base/white paint stainless steel cover / nickle

lampping LED 9W / Ra>80 /900LM

Beam indirect light / acrylic diffuser  
2700K/3000K/4000K/6000K

installation IP20

surface customizable material steel

- black paint equal to RAL9011
- white paint similar to RAL9003
- concrete grey paint similar to RAL7037

cover customized to be any drawing





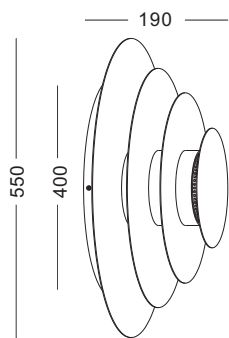
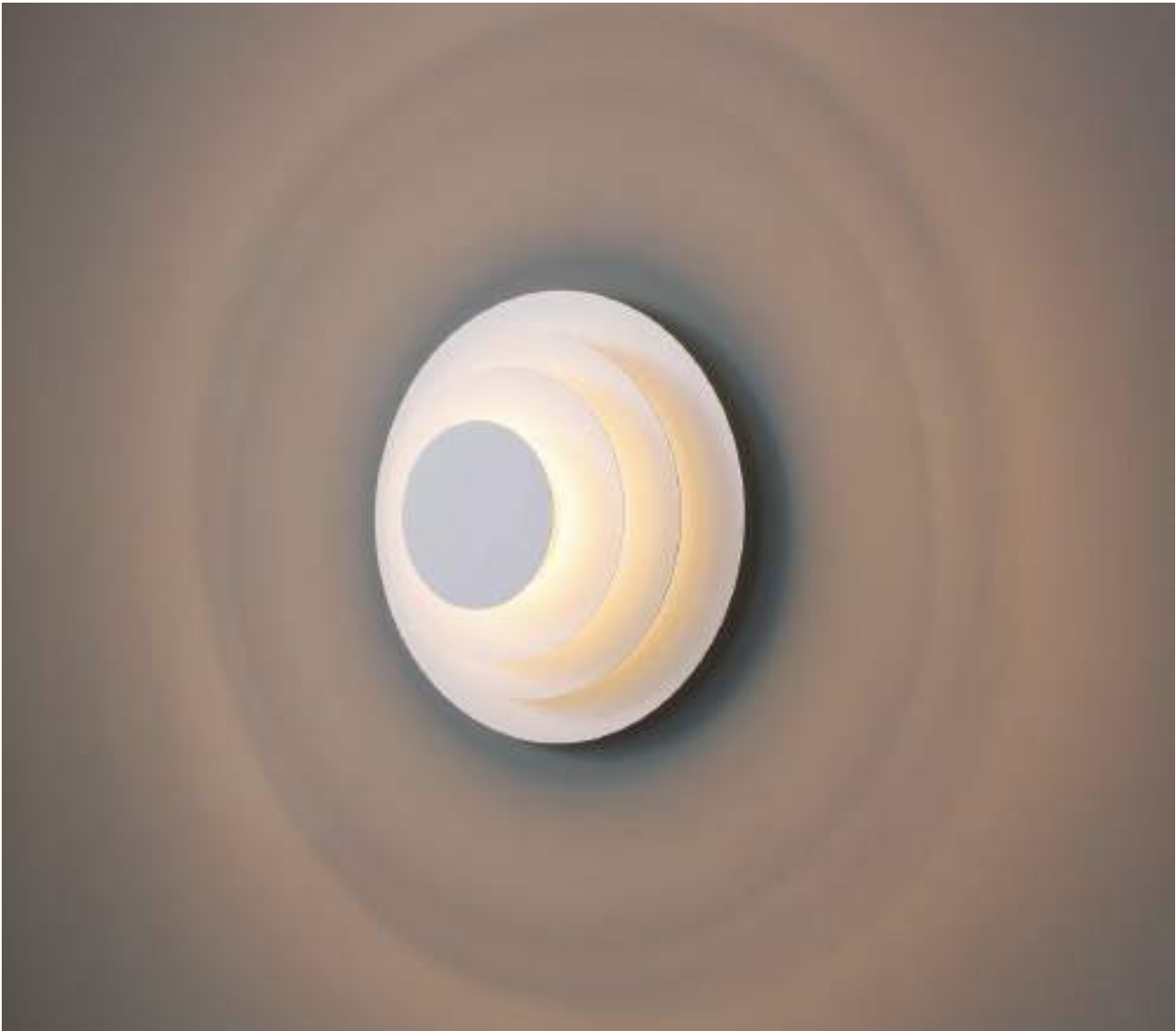

code **LWA318-WT**  
 casing steel sheet / white paint / aluminum heat sink  
 lamping LED 18W / Ra>80 / 1800LM  
 Beam indirect light / 2700K/~~3000K~~/4000K/6000K  
 installation     IP20

code **LWA318-GR**  
 casing steel sheet / grey paint

Related product type  
 ceiling surface mount / pendant

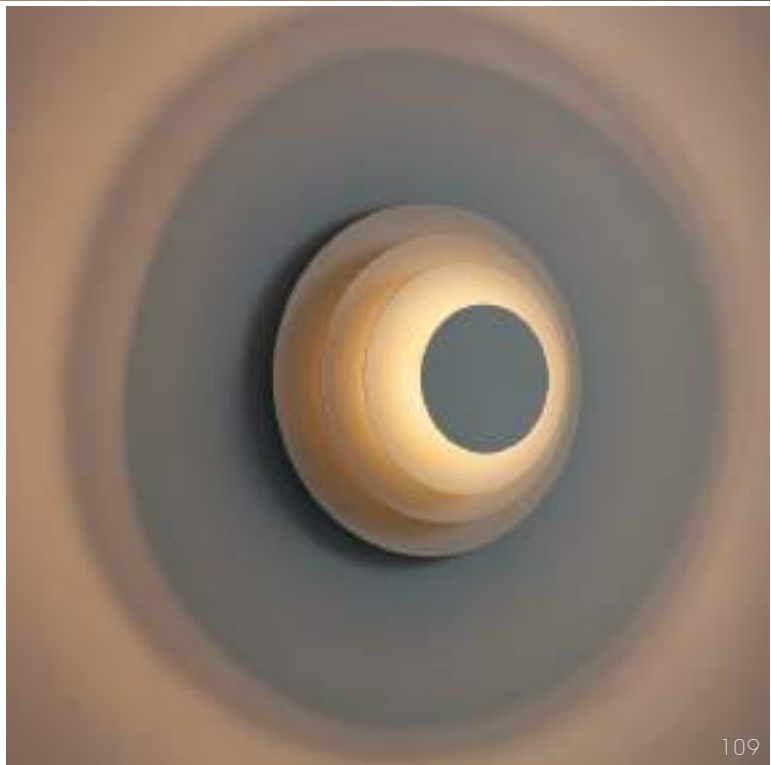

---

# LED STEP LIGHT



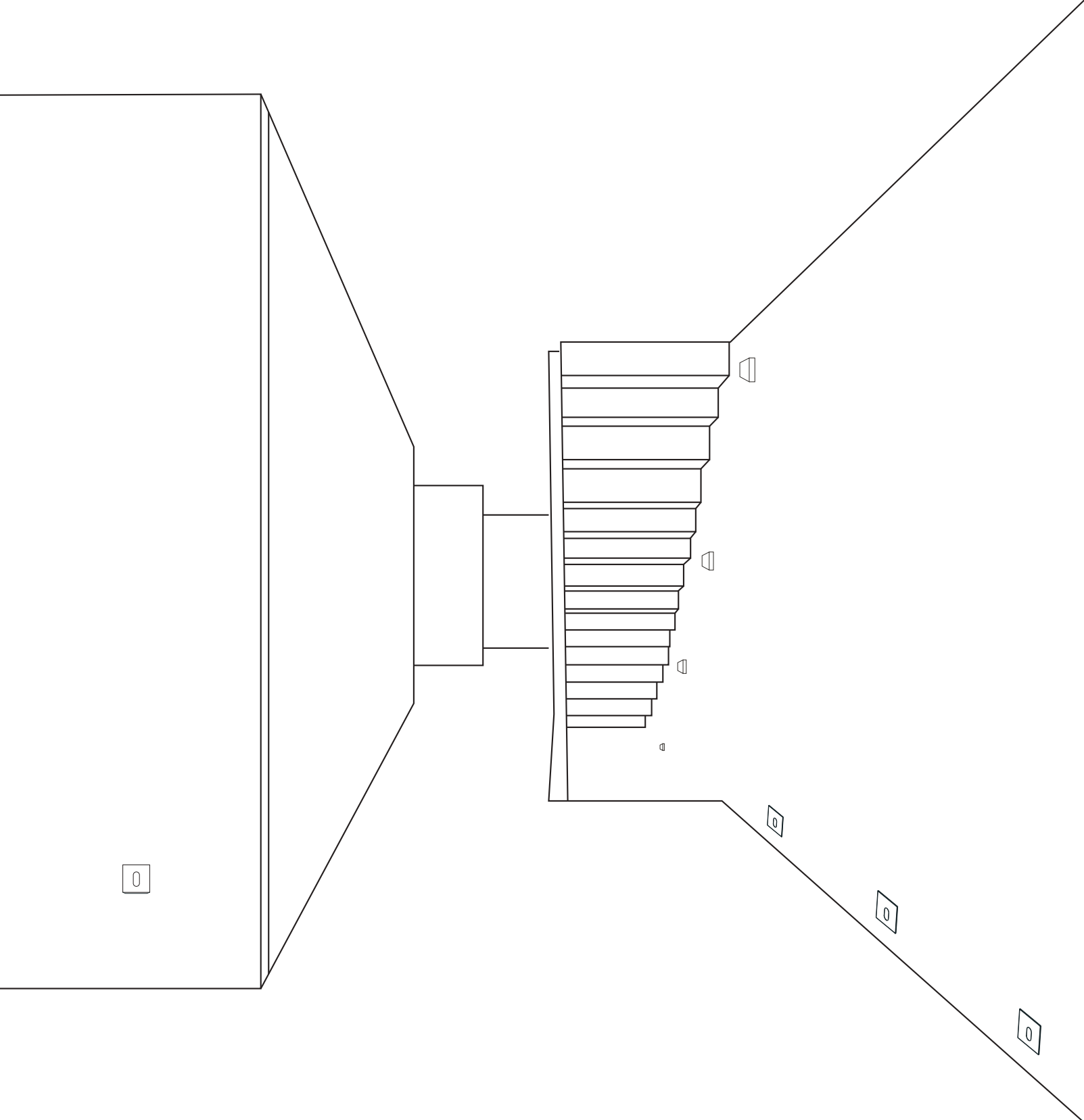



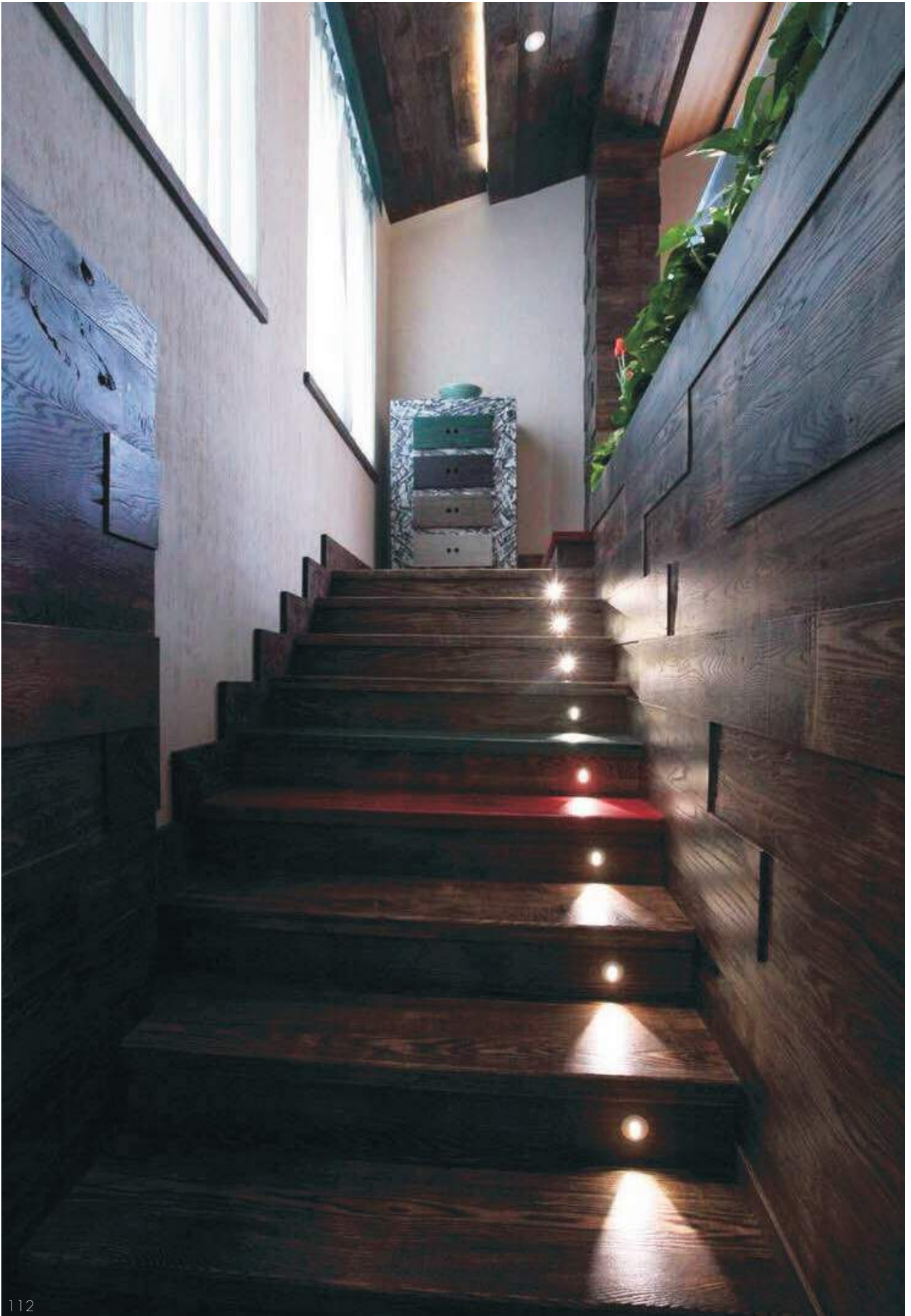



code **LSL001**

casing aluminum / anodized silver

lampping LED 1W / Ra>80 / 70LM

Beam no lense /

2700K/~~3000K~~/4000K/6000K

installation   IP20

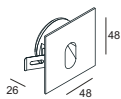

 dia 45x95mm  
for installation box  
for concrete wall

 dia 40mm recessed  
for wooden wall

supply with aluminum installation box

code **LSL002**

casing aluminum / anodized silver

lampping LED 1W / Ra>80 / 70LM

Beam no lense /

2700K/~~3000K~~/4000K/6000K

installation   IP20



 dia 45x95mm  
for installation box  
for concrete wall

 dia 40mm recessed  
for wooden wall

supply with aluminum installation box



code **LSL003**  
 casing aluminum / anodized silver  
 lamping LED 1W / Ra>80 / 70LM  
 Beam no lense /  
 2700K/3000K/4000K/6000K

installation   **IP20**

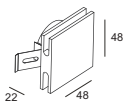

-  dia 45x95mm  
for installation box  
for concrete wall
-  dia 40mm recessed  
for wooden wall

supply with aluminum installation box



code **LSL004**  
 casing aluminum / anodized silver  
 lamping LED 1W / Ra>80 / 70LM  
 Beam no lense /  
 2700K/3000K/4000K/6000K

installation   **IP20**

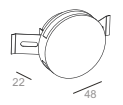

-  dia 45x95mm  
for installation box  
for concrete wall
-  dia 40mm recessed  
for wooden wall

supply with aluminum installation box





code **LSL008**  
 casing aluminum / anodized silver  
 lamping LED 1W / Ra>80 / 70LM  
 Beam acrylic diffuser/  
 2700K/~~3000K~~/4000K/6000K  
 installation   **IP20**

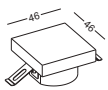

-  dia 45x95mm for installation box for concrete wall
-  dia 40mm recessed for wooden wall

supply with aluminum installation box

code **LSL009**  
 casing aluminum / anodized silver  
 lamping LED 1W / Ra>80 / 70LM  
 Beam acrylic diffuser/  
 2700K/~~3000K~~/4000K/6000K  
 installation   **IP20**

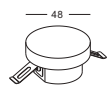

-  dia 45x95mm for installation box for concrete wall
-  dia 40mm recessed for wooden wall

supply with aluminum installation box

code **LSL008A**

casing aluminum / anodized silver  
stainless steel cover / nickel

lampping LED 1W / Ra>80 / 70LM

Beam acrylic diffuser/  
2700K/3000K/4000K/6000K

installation    IP20



supply with aluminum installation box



code **LSL009A**

casing aluminum / anodized silver  
stainless steel cover / nickel

lampping LED 1W / Ra>80 / 70LM

Beam acrylic diffuser/  
2700K/3000K/4000K/6000K

installation    IP20

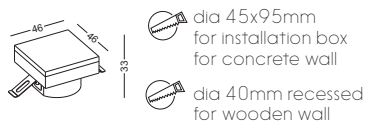

supply with aluminum installation box

surface customizable

-  anodized silver brushed linear
-  anodized gold brushed circular
-  black paint equal to RAL9011
-  white paint similar to RAL9003
-  concrete grey paint similar to RAL7037

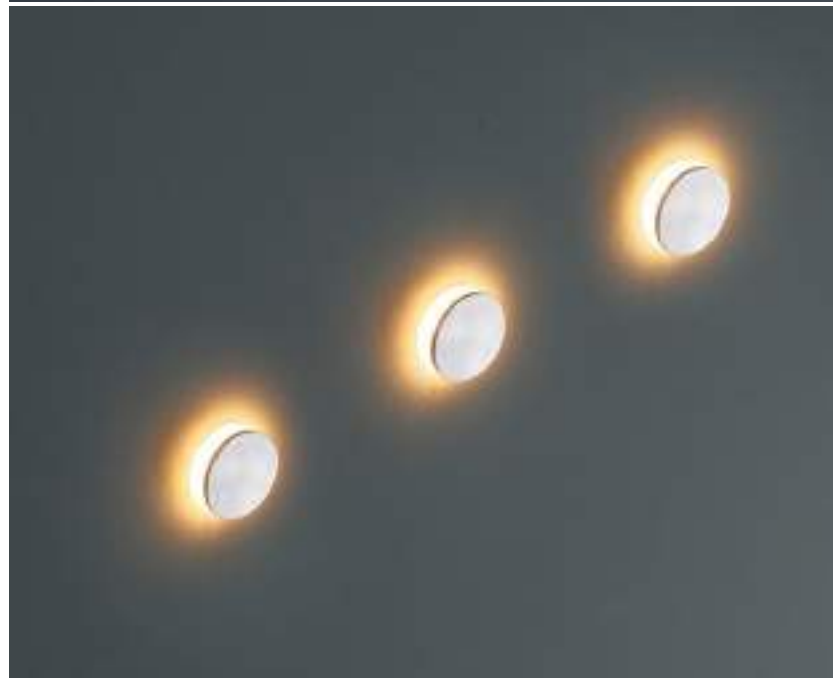



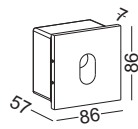
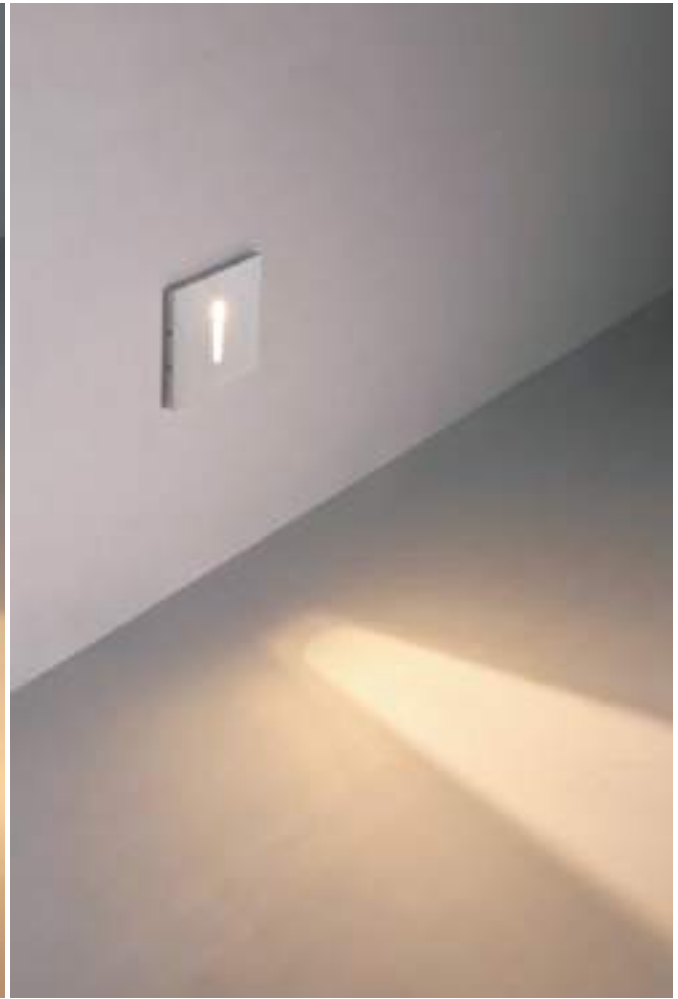

code **LSL011**  
 casing aluminum / anodized silver  
 lamping LED 1W / Ra>80 / 70LM  
 Beam 60 degree / no lense  
 2700K/~~3000K~~/4000K/6000K  
 installation  **CE**  **IP20**

 installed with standard 86x86mm switch box

supply with standard 86mm switch box

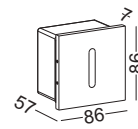

code **LSL013**  
 casing aluminum / anodized silver  
 lamping LED 1W / Ra>80 / 70LM  
 Beam 30 degree / no lense  
 2700K/~~3000K~~/4000K/6000K  
 installation  **CE**  **IP20**

 installed with standard 86x86mm switch box

supply with standard 86mm switch box



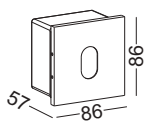

code **LSL011A**  
 casing aluminum / chrome plated  
 lamping LED 1W / Ra>80 / 70LM  
 Beam glass diffuser /  
 2700K/~~3000K~~/4000K/6000K

installation IP20

installed with standard 86x86mm switch box

supply with standard 86mm switch box

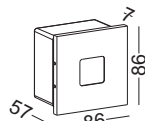

code **LSL012A**  
 casing aluminum / chrome plated  
 lamping LED 1W / Ra>80 / 70LM  
 Beam glass diffuser /  
 2700K/~~3000K~~/4000K/6000K

installation IP20

installed with standard 86x86mm switch box

supply with standard 86mm switch box

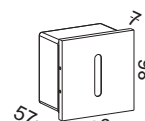

code **LSL013A**  
 casing aluminum / chrome plated  
 lamping LED 1W / Ra>80 / 70LM  
 Beam glass diffuser /  
 2700K/~~3000K~~/4000K/6000K

installation IP20

installed with standard 86x86mm switch box

supply with standard 86mm switch box



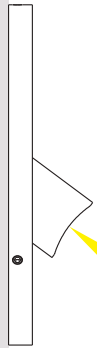
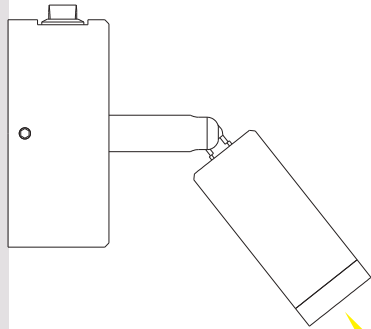

LED  
READING  
LIGHTS

FOR  
BEDROOM

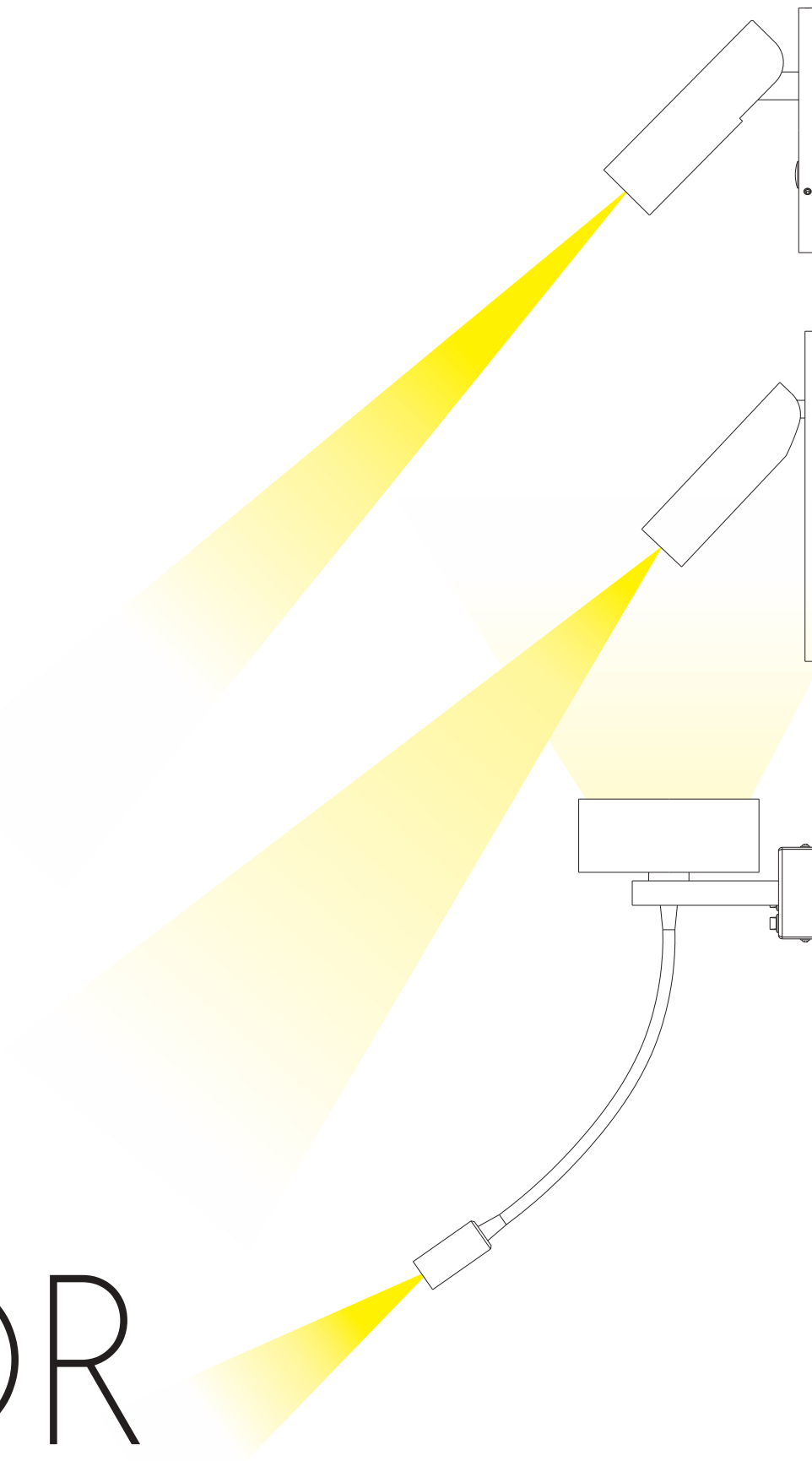



LWA219-BK

---



LWA219-WT

---



LWA219-SL

---



LWA219-CR

---



LWA219-RG

---



LWA220-BK

---



LWA220-WT

---



LWA220-SL

---



LWA220-CR

---

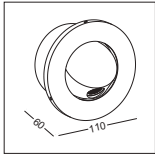

code **LWA219-WT**  
 casing aluminum / white paint  
 lamping LED 3W / Ra>80 / 120LM  
 Beam 30 degree /  
 2700K/3000K/4000K/6000K

installation **IP20**

cut-off dia80mm  
 by 60mm depth hole for  
 installation box and driver

supplied with installation box and driver

with built-in switch, when head pressed  
 in ,the light switched off

the head can be rotated 350 degree  
 left and right, 90 degree up and down



code **LWA219-BK**  
 casing aluminum / black paint

code **LWA219-CR**  
 casing aluminum / chrome plated

code **LWA219-SL**  
 casing aluminum / anodized silver

code **LWA219-RG**  
 casing aluminum / anodized rose gold

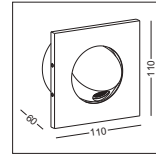

code **LWA220-WT**  
 casing aluminum / white paint  
 lamping LED 3W / Ra>80 / 120LM  
 Beam 30 degree /  
 2700K/3000K/4000K/6000K

installation **IP20**

cut-off dia80mm  
 by 60mm depth hole for  
 installation box and driver

supplied with installation box and driver

with built-in switch, when head pressed  
 in ,the light switched off

the head can be rotated 350 degree  
 left and right, 90 degree up and down



code **LWA220-BK**  
 casing aluminum / black paint

code **LWA220-CR**  
 casing aluminum / chrome plated

code **LWA220-SL**  
 casing aluminum / anodized silver

code **LWA220-RD**  
 casing aluminum / anodized rose gold

## HOW IT WORKS

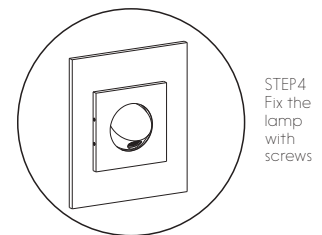
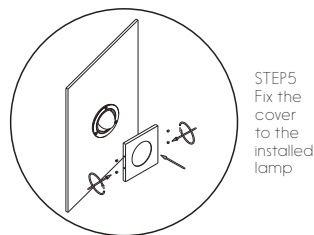
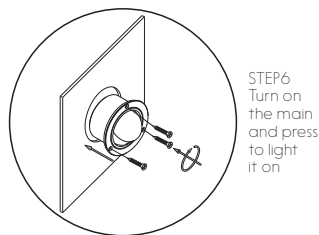
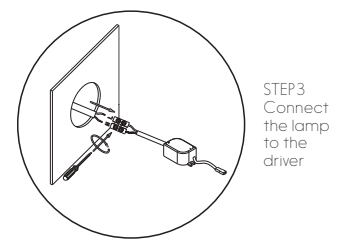
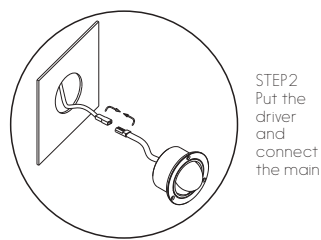
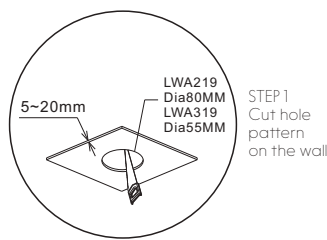







LWA319-WT

---



LWA320-WT

---



LWA319-BK

---



LWA320-BK

---



LWA319-SL

---



LWA320-SL

---



LWA319-CR

---



LWA320-CR

---

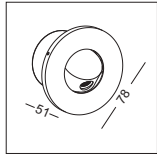

## SMALLER VERSION FOR LWA219 SERIES



code **LWA319-WT**  
 casing aluminum / white paint  
 lamping LED 1W / Ra>80 /70LM  
 Beam 30 degree /  
 2700K/~~3000K~~/4000K/6000K



installation IP20  
 cut-off dia55mm  
 by 60mm depth hole for  
 installation box and driver



supplied with installation box and driver



with built-in switch, when head pressed  
 in ,the light switched off

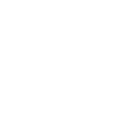

the head can be rotated 350 degree  
 left and right, 90 degree up and down

code **LWA319-BK**  
 casing aluminum / black paint

code **LWA319-CR**  
 casing aluminum / chrome plated

code **LWA319-SL**  
 casing aluminum / anodized silver

code **LWA319-RG**  
 casing aluminum / anodized rose gold

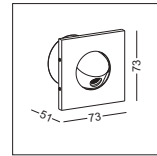

## SMALLER VERSION FOR LWA220 SERIES



code **LWA320-WT**  
 casing aluminum / white paint  
 lamping LED 1W / Ra>80 /70LM  
 Beam 30 degree /  
 2700K/~~3000K~~/4000K/6000K



installation IP20  
 cut-off dia55mm  
 by 60mm depth hole for  
 installation box and driver



supplied with installation box and driver



with built-in switch, when head pressed  
 in ,the light switched off



the head can be rotated 350 degree  
 left and right, 90 degree up and down

code **LWA320-BK**  
 casing aluminum / black paint

code **LWA320-CR**  
 casing aluminum / chrome plated

code **LWA320-SL**  
 casing aluminum / anodized silver

code **LWA320-RG**  
 casing aluminum / anodized rose gold

## HOW IT WORKS

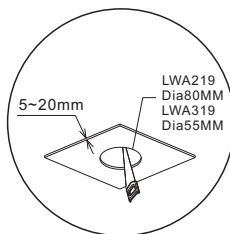

STEP1  
 Cut hole  
 pattern  
 on the wall

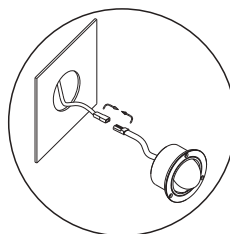

STEP2  
 Put the  
 driver  
 and  
 connect  
 the main

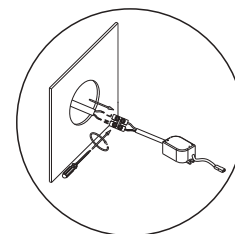

STEP3  
 Connect  
 the lamp  
 to the  
 driver

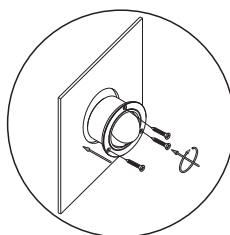

STEP6  
 Turn on  
 the main  
 and press  
 to light  
 it on

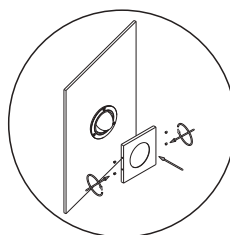

STEP5  
 Fix the  
 cover  
 to the  
 installed  
 lamp

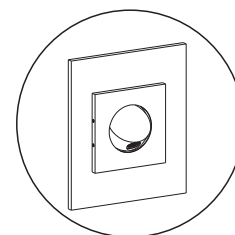

STEP4  
 Fix the  
 lamp  
 with  
 screws



code **LWA260-BK**  
 casing aluminum / black paint  
 lamping LED 3W / Ra>80 / 120LM  
 Beam 30 degree /  
 2700K/3000K/4000K/6000K  
 installation

supplied with installation box and driver  
 with touching sensor switch

the head can be rotated 350 degree  
 left and right, 90 degree up and down

surface customizable anodized silver brushed circular  
 anodized gold brushed circular  
 concrete grey paint similar to RAL7037

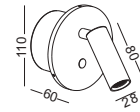

cut-off dia80mm  
 by 60mm depth hole for  
 installation box and driver

if there is no enough space  
 for the box, we can supply  
 an aluminum ring for insta-  
 llatoin.



code **LWA260-WT**  
 casing aluminum / white paint  
 lamping LED 3W / Ra>80 / 120LM  
 Beam 30 degree /  
 2700K/3000K/4000K/6000K  
 installation

supplied with installation box and driver  
 with touching sensor switch

the head can be rotated 350 degree  
 left and right, 90 degree up and down

surface customizable anodized silver brushed circular  
 anodized gold brushed circular  
 concrete grey paint similar to RAL7037



cut-off dia80mm  
 by 60mm depth hole for  
 installation box and driver

if there is no enough space  
 for the box, we can supply  
 an aluminum ring for insta-  
 llatoin.



code **LWA260-CR**  
 casing aluminum / Chrome plated  
 lamping LED 3W / Ra>80 / 120LM  
 Beam 30 degree /  
 2700K/3000K/4000K/6000K  
 installation

supplied with installation box and driver  
 with touching sensor switch

the head can be rotated 350 degree  
 left and right, 90 degree up and down

surface customizable anodized silver brushed circular  
 anodized gold brushed circular  
 concrete grey paint similar to RAL7037



cut-off dia80mm  
 by 60mm depth hole for  
 installation box and driver

if there is no enough space  
 for the box, we can supply  
 an aluminum ring for insta-  
 llatoin.

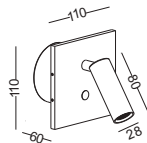

cut-off dia80mm  
by 60mm depth hole for  
installation box and driver

if there is no enough space  
for the box, we can supply  
an aluminum ring for insta-  
llation.

code **LWA259-BK**  
casing aluminum / black paint  
lamping LED 3W / Ra>80 / 120LM  
Beam 30 degree /  
2700K/~~3000K~~/4000K/6000K  
installation IP20  
supplied with installation box and driver

with touching sensor switch  
the head can be rotated 350 degree  
left and right, 90 degree up and down

surface customizable anodized silver  
brushed circular  
 anodized gold  
brushed circular  
 concrete grey paint  
similar to RAL7037

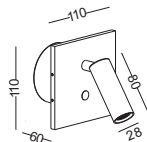

cut-off dia80mm  
by 60mm depth hole for  
installation box and driver

if there is no enough space  
for the box, we can supply  
an aluminum ring for insta-  
llation.

code **LWA259-WT**  
casing aluminum / white paint  
lamping LED 3W / Ra>80 / 120LM  
Beam 30 degree /  
2700K/~~3000K~~/4000K/6000K  
installation IP20  
supplied with installation box and driver

with touching sensor switch  
the head can be rotated 350 degree  
left and right, 90 degree up and down

surface customizable anodized silver  
brushed circular  
 anodized gold  
brushed circular  
 concrete grey paint  
similar to RAL7037

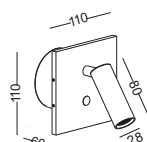

cut-off dia80mm  
by 60mm depth hole for  
installation box and driver

if there is no enough space  
for the box, we can supply  
an aluminum ring for insta-  
llation.

code **LWA259-CR**  
casing aluminum / Chrome plated  
lamping LED 3W / Ra>80 / 120LM  
Beam 30 degree /  
2700K/~~3000K~~/4000K/6000K  
installation IP20  
supplied with installation box and driver

with touching sensor switch  
the head can be rotated 350 degree  
left and right, 90 degree up and down

surface customizable anodized silver  
brushed circular  
 anodized gold  
brushed circular  
 concrete grey paint  
similar to RAL7037



THE BEST READING LAMP EVER DESIGNED  
 360 DEGREE FREE TURNING  
 DEEP RECESSED LIGHT  
 FOR ANTI-GLARE PURPOSE  
 TURNING BACK AND SWITCHED OFF  
 SMART AND EASY INSTALLATION  
 BY SCREWING IN ONE NUT  
 CHROME /GOLD PLATED  
 BLACK / WHITE PAINTING  
 FOUR FINISHINGS AVAILABLE  
 SMALL/BIG TWO SIZES OPTIONAL



code **LWA322-CR**

casing aluminum / chrome plated

lamplight LED 3W / Ra>80 / 120LM

Beam 30 degree /

2700K/3000K/4000K/6000K

installation IP20

cut-off 150x45mm  
 by 105mm depth hole for  
 installation box and driver

supplied with installation box and driver

with built-in switch, when head pressed  
 in, the light switched off

the head can be rotated 350 degree  
 left and right, 90 degree up and down

code **LWA322-BK**

casing aluminum / black paint

code **LWA322-WT**

casing aluminum / white paint

code **LWA322-GD**

casing aluminum / gold plated

surface customizable anodized silver  
 brushed linear

concrete grey paint  
 similar to RAL7037

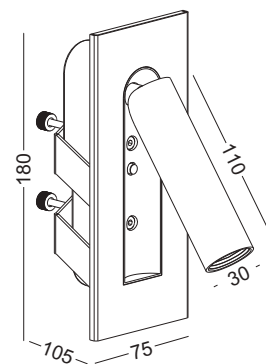



LWA322-BK



LWA322-WT



LWA322-GD

## HOW IT WORKS

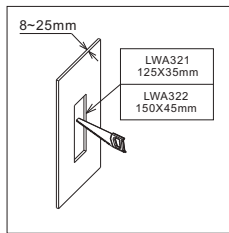

STEP 1  
Cut hole  
pattern  
on the  
wall

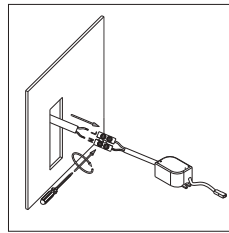

STEP 2  
Put the  
driver  
and  
connect  
to the  
main

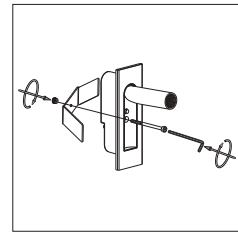

STEP 3  
Fix the  
metal  
parts  
to the  
lamp  
with the  
long nut

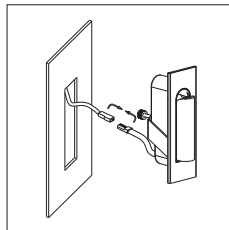

STEP 3  
Connect  
the lamp  
with the  
driver

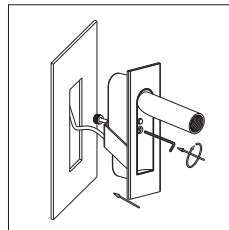

STEP 4  
Put the  
lamp into  
the hole  
drive the  
screw to the  
opposite  
direction  
to fasten  
the metal  
part

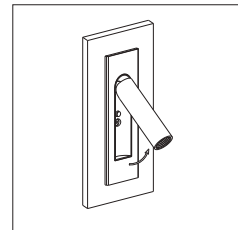

STEP 5  
Pull out  
the lamp  
head  
and light  
it on

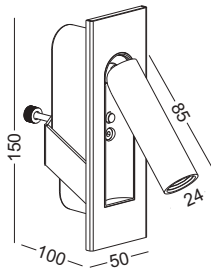

THE BEST READING LAMP EVER DESIGNED

360 DEGREE FREE TURNING

DEEP RECESSED LIGHT

FOR ANTI-GLARE PURPOSE

TURNING BACK AND SWITCHED OFF

SMART AND EASY INSTALLATION

BY SCREWING IN ONE NUT

CHROME /GOLD PLATED

BLACK / WHITE PAINTING

FOUR FINISHINGS AVAILABLE

SMALL/BIG TWO SIZES OPTIONAL

code **LWA321-CR**

casing aluminum / chrome plated

lamplight LED 3W / Ra>80 / 120LM

Beam 30 degree /

2700K/3000K/4000K/6000K

installation     IP20



cut-off 125x35mm

by 105mm depth hole for  
installation box and driver

supplied with installation box and driver

with built-in switch, when head pressed  
in, the light switched off

the head can be rotated 350 degree  
left and right, 90 degree up and down

code **LWA321-BK**

casing aluminum / black paint

code **LWA321-WT**

casing aluminum / white paint

code **LWA321-GD**

casing aluminum / gold plated

surface customizable  anodized silver  
brushed linear

 concrete grey paint  
similar to RAL7037



LWA321-WT



LWA321-BK



LWA321-GD

## HOW IT WORKS

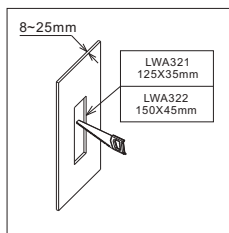

STEP 1  
Cut hole  
pattern  
on the  
wall

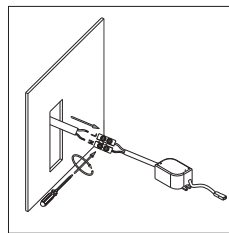

STEP 2  
Put the  
driver  
and  
connect  
to the  
main

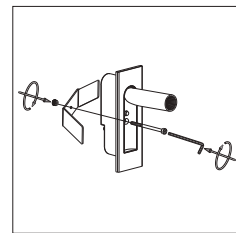

STEP 3  
Fix the  
metal  
parts  
to the  
lamp  
with the  
long nut

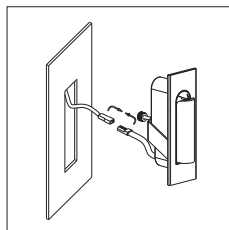

STEP 3  
Connect  
the lamp  
with the  
driver

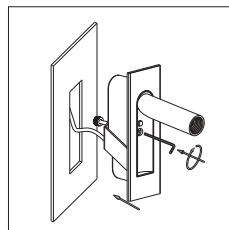

STEP 4  
Put the  
lamp into  
the hole  
drive the  
screw to the  
opposite  
direction  
to fasten  
the metal  
part

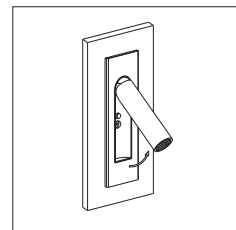

STEP 5  
Pull out  
the lamp  
head  
and light  
it on



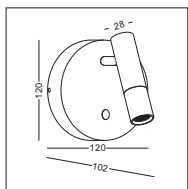

code **LWA315-WT**  
 casing aluminum+beech  
 finishing white paint  
 lamping LED 3W  
 Lumens 120LM  
 CRI Ra>80  
 Beam 10 / 20 / 30 degree  
 lamp color 2700K/3000K/4000K/6000K



with touching sensor switch

lens available

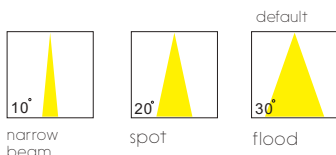

surface customizable

-  anodized silver brushed circular
-  anodized gold sandblasted
-  concrete grey paint similar to RAL7037

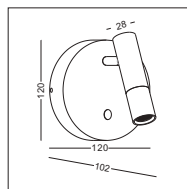

code **LWA315-BK**  
 casing aluminum+beech  
 finishing anodized black  
 lamping LED 3W  
 Lumens 120LM  
 CRI Ra>80  
 Beam 10 / 20 / 30 degree  
 lamp color 2700K/3000K/4000K/6000K



with touching sensor switch

lens available

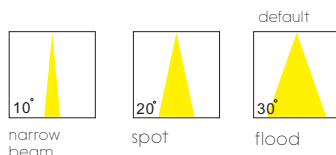

surface customizable

-  anodized silver brushed circular
-  anodized gold sandblasted
-  concrete grey paint similar to RAL7037

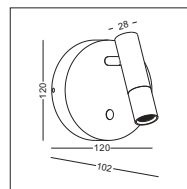

code **LWA315-CR**  
 casing aluminum+beech  
 finishing chrome plated  
 lamping LED 3W  
 Lumens 120LM  
 CRI Ra>80  
 Beam 10 / 20 / 30 degree  
 lamp color 2700K/3000K/4000K/6000K



with touching sensor switch

lens available

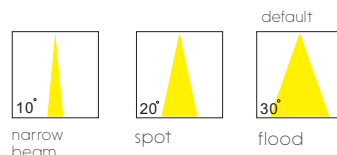

surface customizable

-  anodized silver brushed circular
-  anodized gold sandblasted
-  concrete grey paint similar to RAL7037

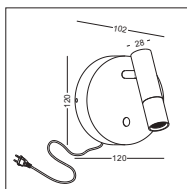

code **LWA314-WT**  
 casing aluminum+beech  
 finishing white paint  
 lamping LED 3W  
 Lumens 120LM  
 CRI Ra>80  
 Beam 10 / 20 / **30** degree  
 lamp color 2700K/**3000K**/4000K/6000K



with touching sensor switch

lens available

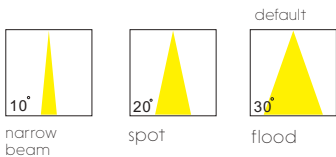

surface customizable

- anodized silver brushed circular
- anodized gold sandblasted
- concrete grey paint similar to RAL7037

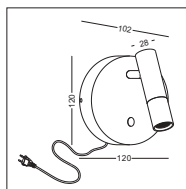

code **LWA314-BK**  
 casing aluminum+beech  
 finishing anodized black  
 lamping LED 3W  
 Lumens 120LM  
 CRI Ra>80  
 Beam 10 / 20 / **30** degree  
 lamp color 2700K/**3000K**/4000K/6000K



with touching sensor switch

lens available

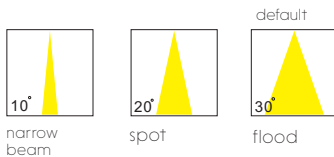

surface customizable

- anodized silver brushed circular
- anodized gold sandblasted
- concrete grey paint similar to RAL7037

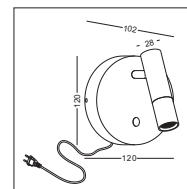

code **LWA314-CR**  
 casing aluminum+beech  
 finishing chrome plated  
 lamping LED 3W  
 Lumens 120LM  
 CRI Ra>80  
 Beam 10 / 20 / **30** degree  
 lamp color 2700K/**3000K**/4000K/6000K



with touching sensor switch

lens available

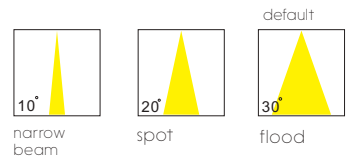

surface customizable

- anodized silver brushed circular
- anodized gold sandblasted
- concrete grey paint similar to RAL7037

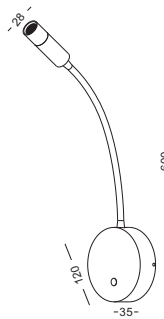

code **LWA317-WT**  
 casing aluminum+beech  
 finishing white paint  
 lamping LED 3W  
 Lumens 120LM  
 CRI Ra>80  
 Beam 10 / 20 / 30 degree  
 lamp color 2700K/3000K/4000K/6000K



with touching sensor switch

lens available

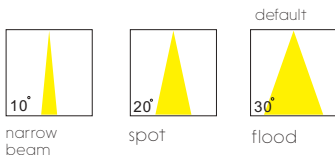

surface customizable

-  anodized silver brushed circular
-  anodized gold sandblasted
-  concrete grey paint similar to RAL7037

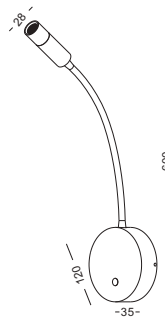

code **LWA317-BK**  
 casing aluminum+beech  
 finishing anodized black  
 lamping LED 3W  
 Lumens 120LM  
 CRI Ra>80  
 Beam 10 / 20 / 30 degree  
 lamp color 2700K/3000K/4000K/6000K



with touching sensor switch

lens available

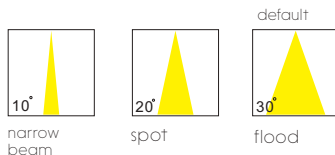

surface customizable

-  anodized silver brushed circular
-  anodized gold sandblasted
-  concrete grey paint similar to RAL7037

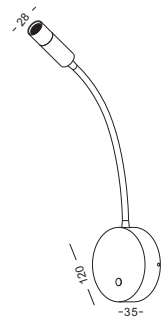

code **LWA317-CR**  
 casing aluminum+beech  
 finishing chrome plated  
 lamping LED 3W  
 Lumens 120LM  
 CRI Ra>80  
 Beam 10 / 20 / 30 degree  
 lamp color 2700K/3000K/4000K/6000K



with touching sensor switch

lens available

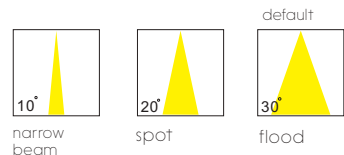

surface customizable

-  anodized silver brushed circular
-  anodized gold sandblasted
-  concrete grey paint similar to RAL7037

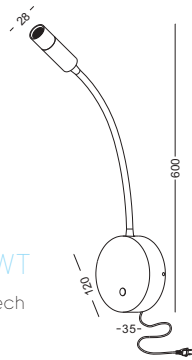

code **LWA316-WT**  
 casing aluminum+beech  
 finishing white paint  
 lamping LED 3W  
 Lumens 120LM  
 CRI Ra>80  
 Beam 10 / 20 / **30** degree  
 lamp color 2700K/**3000K**/4000K/6000K



with touching sensor switch

lens available

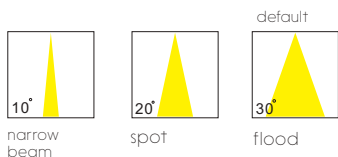

surface customizable

- anodized silver brushed circular
- anodized gold sandblasted
- concrete grey paint similar to RAL7037

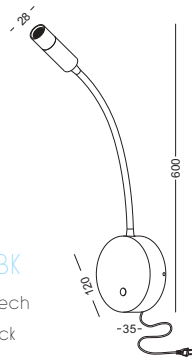

code **LWA316-BK**  
 casing aluminum+beech  
 finishing anodized black  
 lamping LED 3W  
 Lumens 120LM  
 CRI Ra>80  
 Beam 10 / 20 / **30** degree  
 lamp color 2700K/**3000K**/4000K/6000K



with touching sensor switch

lens available

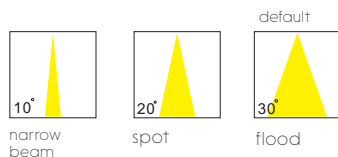

surface customizable

- anodized silver brushed circular
- anodized gold sandblasted
- concrete grey paint similar to RAL7037

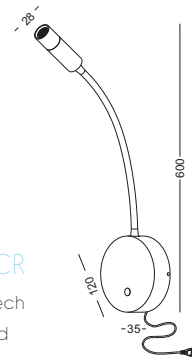

code **LWA316-CR**  
 casing aluminum+beech  
 finishing chrome plated  
 lamping LED 3W  
 Lumens 120LM  
 CRI Ra>80  
 Beam 10 / 20 / **30** degree  
 lamp color 2700K/**3000K**/4000K/6000K



with touching sensor switch

lens available

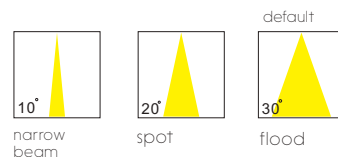

surface customizable

- anodized silver brushed circular
- anodized gold sandblasted
- concrete grey paint similar to RAL7037



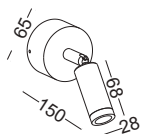

code **LWA205**  
 casing aluminum / anodized black  
 lamping LED 3W / Ra>80 / 120LM  
 Beam 30 degree /  
 2700K/3000K/4000K/6000K  
 installation       IP20

surface customizable  white paint similar to RAL9003  
 concrete grey paint similar to RAL7037

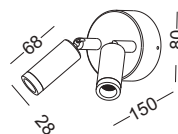

code **LWA206**  
 casing aluminum / anodized black  
 lamping LED 2x3W / Ra>80 / 240LM  
 Beam 30 degree /  
 2700K/3000K/4000K/6000K  
 installation       IP20

surface customizable  white paint similar to RAL9003  
 concrete grey paint similar to RAL7037

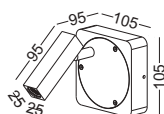

code **LWA203**  
 casing aluminum / anodized black  
 lamping LED 3W / Ra>80 / 120LM  
 Beam 30 degree /  
 2700K/3000K/4000K/6000K  
 installation       IP20

surface customizable  white paint similar to RAL9003  
 concrete grey paint similar to RAL7037

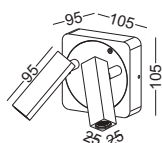

code **LWA204**  
 casing aluminum / anodized black  
 lamping LED 2x3W / Ra>80 / 240LM  
 Beam 30 degree /  
 2700K/3000K/4000K/6000K  
 installation       IP20

surface customizable  white paint similar to RAL9003  
 concrete grey paint similar to RAL7037



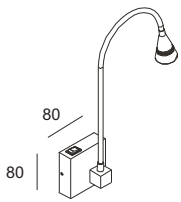

code **LWA067**  
 casing aluminum / anodized silver  
 lamping LED 3W / Ra>80 / 120LM  
 Beam 30 degree /  
 2700K/~~3000K~~/4000K/6000K  
 installation       IP20

---

surface customizable  white paint similar to RAL9003

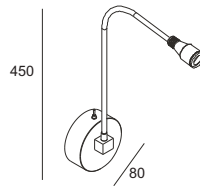

code **LWA070B**  
 casing aluminum / anodized silver  
 lamping LED 3W / Ra>80 / 120LM  
 Beam 30 degree /  
 2700K/~~3000K~~/4000K/6000K  
 installation       IP20

---

surface customizable  white paint similar to RAL9003

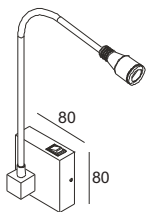

code **LWA070**  
 casing aluminum / anodized silver  
 lamping LED 3W / Ra>80 / 120LM  
 Beam 30 degree /  
 2700K/~~3000K~~/4000K/6000K  
 installation       IP20

---

surface customizable  white paint similar to RAL9003

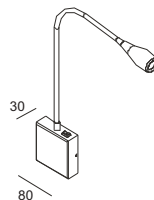

code **LWA061**  
 casing aluminum / anodized silver  
 lamping LED 3W / Ra>80 / 120LM  
 Beam 30 degree /  
 2700K/~~3000K~~/4000K/6000K  
 installation       IP20

---

surface customizable  white paint similar to RAL9003



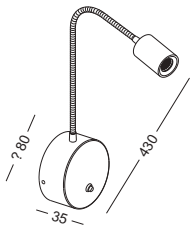

code **HL9003/1**  
 casing aluminum / anodized silver  
 lamping LED 3W / Ra>80 / 120LM  
 Beam 30 degree /  
 2700K/3000K/4000K/6000K  
 installation IP20

---

surface customizable white paint similar to RAL9003

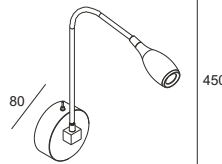

code **LWA067B**  
 casing aluminum / anodized silver  
 lamping LED 3W / Ra>80 / 120LM  
 Beam 30 degree /  
 2700K/3000K/4000K/6000K  
 installation IP20

---

surface customizable white paint similar to RAL9003

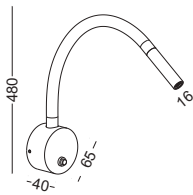

code **LWA224**  
 casing aluminum / chrome plated  
 lamping LED 1W / Ra>80 / 70LM  
 Beam 30 degree /  
 2700K/3000K/4000K/6000K  
 installation IP20

---

surface customizable white paint similar to RAL9003

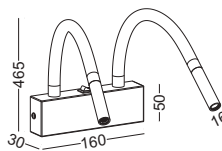



code **LWA225**  
 casing aluminum / chrome plated  
 lamping LED 2W / Ra>80 / 140LM  
 Beam 30 degree /  
 2700K/3000K/4000K/6000K  
 installation IP20

---

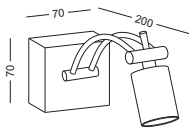
surface customizable white paint similar to RAL9003



code **HL8019A**  
 casing aluminum / anodized silver  
 lamping LED 3W / Ra>80 / 120LM  
 Beam 30 degree /  
 2700K/~~3000K~~/4000K/6000K  
 installation     IP20

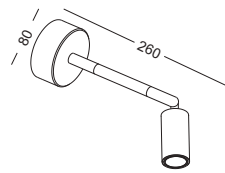

code **HL8019B**  
 casing aluminum / anodized silver  
 lamping LED 3W / Ra>80 / 120LM  
 Beam 30 degree /  
 2700K/~~3000K~~/4000K/6000K  
 installation      IP20

surface customizable  white paint similar to RAL9003  
 anodized black sandblasted  
 concrete grey paint similar to RAL7037

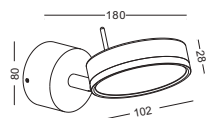

code **LWA186**  
 casing aluminum / anodized silver  
 lamping COB 5W / Ra>90 / 430LM  
 Beam No lense / acrylic cover  
 2700K/~~3000K~~/4000K/6000K  
 installation     IP20

surface customizable  white paint similar to RAL9003



code **LWA230A-CR**  
 casing aluminum / Chrome plated  
 lamping LED 3W / Ra>80 / 120LM  
 Beam 30 degree /  
 2700K/3000K/4000K/6000K

installation   **CE**  **IP20**

supplied with installation box and driver

with touching sensor switch

surface customizable  white paint similar to RAL9003  
 black paint equal to RAL9011

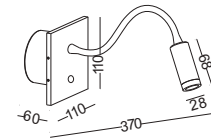

 cut-off dia8.2mm by 60mm depth hole for installation box and driver

if there is no enough space for the box, we can supply an aluminum ring for installation.



code **LWA230-CR**  
 casing aluminum / Chrome plated  
 lamping LED 3W / Ra>80 / 120LM  
 Beam 30 degree /  
 2700K/3000K/4000K/6000K

installation   **CE**  **IP20**

supplied with installation box and driver

with touching sensor switch

surface customizable  white paint similar to RAL9003  
 black paint equal to RAL9011

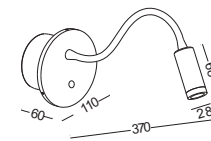

 cut-off dia8.2mm by 60mm depth hole for installation box and driver

if there is no enough space for the box, we can supply an aluminum ring for installation.

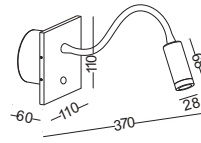

code **LWA230A-BK**  
 casing aluminum / black paint  
 lamping LED 3W / Ra>80 / 120LM  
 Beam 30 degree /  
 2700K/3000K/4000K/6000K  
 installation     IP20

supplied with installation box and driver





with touching sensor switch

 cut-off dia8.2mm  
 by 60mm depth hole for  
 installation box and driver

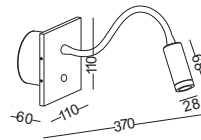
---

if there is no enough space  
 for the box, we can supply  
 an aluminum ring for insta-  
 llatoin.



code **LWA230A-WT**  
 casing aluminum / white paint  
 lamping LED 3W / Ra>80 / 120LM  
 Beam 30 degree /  
 2700K/3000K/4000K/6000K  
 installation     IP20

supplied with installation box and driver

with touching sensor switch

 cut-off dia8.2mm  
 by 60mm depth hole for  
 installation box and driver

---

if there is no enough space  
 for the box, we can supply  
 an aluminum ring for insta-  
 llatoin.

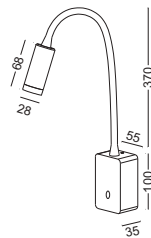

code **LWA232A-BK**  
 casing aluminum / anodized black  
 lamping LED 3W / Ra>80 / 120LM  
 Beam 30 degree /  
 2700K/3000K/4000K/6000K  
 installation IP20

surface customizable white paint similar to RAL9003  
 anodized silver brushed linear  
 chrome plated

with touching sensor switch

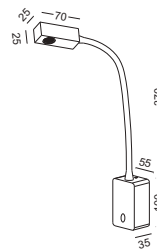





code **LWA231A-WT**  
 casing aluminum / white paint  
 lamping LED 3W / Ra>80 / 120LM  
 Beam 30 degree /  
 2700K/3000K/4000K/6000K  
 installation IP20

surface customizable anodized black sandblasted  
 anodized silver brushed linear  
 chrome plated

with touching sensor switch



code **LWA232A-BK**  
 casing aluminum / anodized black  
 lamping LED 3W / Ra>80 / 120LM  
 Beam 30 degree /  
 2700K/3000K/4000K/6000K  
 installation     IP20

surface customizable  white paint similar to RAL9003  
 anodized silver brushed linear  
 chrome plated





---

with touching sensor switch

---

with 1 meter cable  
 plug can customized EU/AU/US standard



code **LWA231A-WT**  
 casing aluminum / white paint  
 lamping LED 3W / Ra>80 / 120LM  
 Beam 30 degree /  
 2700K/3000K/4000K/6000K  
 installation     IP20

surface customizable  anodized black sandblasted  
 anodized silver brushed linear  
 chrome plated

---

with touching sensor switch

---

with 1 meter cable  
 plug can customized EU/AU/US standard

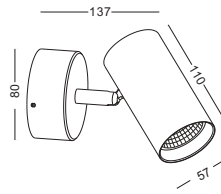

code **LWA187-BK**  
 casing aluminum / anodized black  
 lamping cob 5W / Ra>90 / 430LM  
 Beam 38 degree /  
 2700K/**3000K**/4000K/6000K  
 installation IP20

surface customizable white paint similar to RAL9003  
 concrete grey paint similar to RAL7037  
 anodized silver brushed circular  
 anodized gold brushed circular

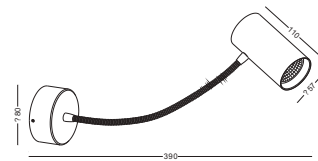

code **LWA188**  
 casing aluminum / anodized black  
 lamping cob 5W / Ra>90 / 430LM  
 Beam 38 degree /  
 2700K/**3000K**/4000K/6000K  
 installation IP20

surface customizable white paint similar to RAL9003









code **LWA200-BK**

casing aluminum / anodized silver

lampping LED 3W / Ra>80 / 120LM

Beam 30 degree /

2700K/**3000K**/4000K/6000K

installation      IP20

code **LWA200-WT**

casing aluminum / White paint

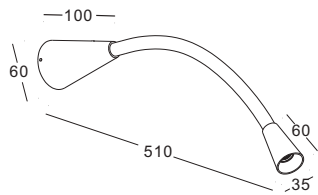

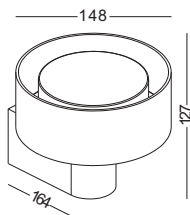

code **LWA297-WT**  
 casing aluminum / white paint  
 lamping LED 6W / Ra>80 / 600LM  
 Beam acrylic diffuser /  
 2700K/~~3000K~~/4000K/6000K  
 installation IP20

surface customizable chrome plated  
 concrete grey paint similar to RAL7037

code **LWA297-BK**  
 casing aluminum / black paint

code **LWA297-GD**  
 casing aluminum / anodized gold  
 lamping LED 6W / Ra>80 / 600LM  
 Beam acrylic diffuser /  
 2700K/~~3000K~~/4000K/6000K  
 installation IP20

surface customizable chrome plated  
 concrete grey paint similar to RAL7037

code **LWA297-SL**  
 casing aluminum / anodized silver





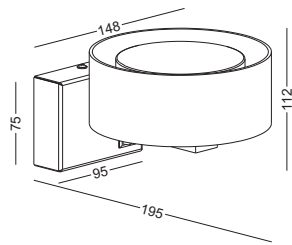

code **LWA298**  
 casing aluminum / chrome plated  
 lamping LED 6W / Ra>80 / 600LM  
 Beam acrylic diffuser /  
 2700K/3000K/4000K/6000K  
 installation

surface customizable  
 black paint equal to RAL9011  
 white paint similar to RAL9003  
 concrete grey paint similar to RAL7037

With switch on the base

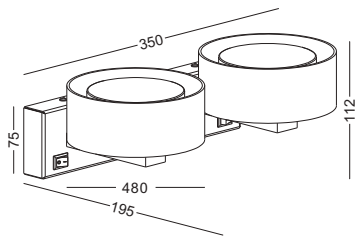

code **LWA299**  
 casing aluminum / chrome plated  
 lamping LED 12W / Ra>80 / 1200LM  
 Beam acrylic diffuser /  
 2700K/3000K/4000K/6000K  
 installation

surface customizable  
 black paint equal to RAL9011  
 white paint similar to RAL9003  
 concrete grey paint similar to RAL7037

With two switches on the base

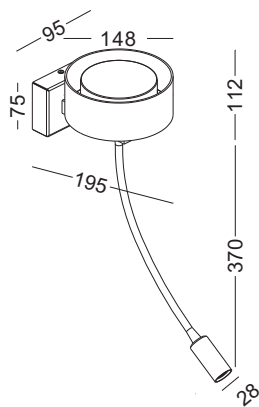

code **LWA298A**  
 casing aluminum / chrome plated  
 lamping Shade LED 6W / Ra>80 / 600LM  
 Goose LED 3W / Ra>80 / 120LM  
 Beam acrylic diffuser /  
 2700K/3000K/4000K/6000K  
 installation

surface customizable  
 black paint equal to RAL9011  
 white paint similar to RAL9003  
 concrete grey paint similar to RAL7037

With two switches on the base

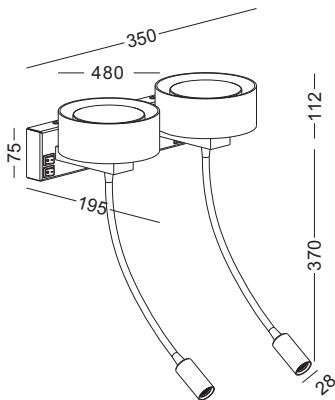

code **LWA299A**  
 casing aluminum / chrome plated  
 lamping Shade LED 12W / Ra>80 / 1200LM  
 Goose LED 2x3W / Ra>80 / 240LM  
 Beam acrylic diffuser /  
 2700K/3000K/4000K/6000K  
 installation

surface customizable  
 black paint equal to RAL9011  
 white paint similar to RAL9003  
 concrete grey paint similar to RAL7037

With four switches on the base

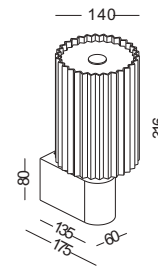

code **LWA289-BK**  
 casing aluminum / anodized black  
 lamping LED 12W / Ra>80 / 1200LM  
 Beam up and down light / acrylic cover  
 2700K/3000K/4000K/6000K  
 installation IP20

---

surface customizable white paint similar to RAL9003

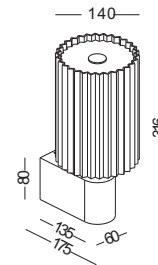

code **LWA289-SL**  
 casing aluminum / anodized silver  
 lamping LED 12W / Ra>80 / 1200LM  
 Beam up and down light / acrylic cover  
 2700K/3000K/4000K/6000K  
 installation IP20

---

surface customizable white paint similar to RAL9003

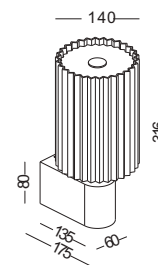

code **LWA289-GD**  
 casing aluminum / anodized gold  
 lamping LED 12W / Ra>80 / 1200LM  
 Beam up and down light / acrylic cover  
 2700K/3000K/4000K/6000K  
 installation IP20

---

surface customizable white paint similar to RAL9003



code **LWA207B**

casing aluminum / anodized silver

lamplig Shade cob 5W / Ra>90 / 430LM  
Goose LED 3W / Ra>80 / 120LM

Beam acrylic diffuser /  
2700K/3000K/4000K/6000K

installation IP20

With two switches on the base

surface customizable

- anodized gold brushed circular
- black paint equal to RAL9011
- white paint similar to RAL9003

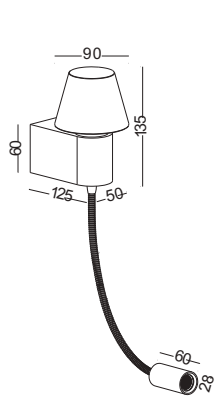

code **LWA208B**

casing aluminum / anodized silver

lamplig Shade cob 5W / Ra>90 / 430LM  
Goose LED 3W / Ra>80 / 120LM

Beam acrylic diffuser /  
2700K/3000K/4000K/6000K

installation IP20

With two switches on the base

surface customizable

- anodized gold brushed circular
- black paint equal to RAL9011
- white paint similar to RAL9003

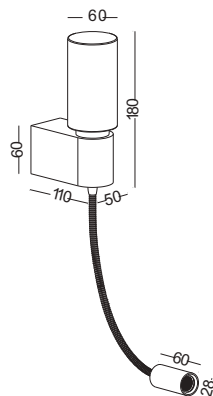

code **LWA209B**

casing aluminum / anodized silver

lamplig Shade cob 5W / Ra>90 / 430LM  
Goose LED 3W / Ra>80 / 120LM

Beam acrylic diffuser /  
2700K/3000K/4000K/6000K

installation IP20

With two switches on the base

surface customizable

- anodized gold brushed circular
- black paint equal to RAL9011
- white paint similar to RAL9003

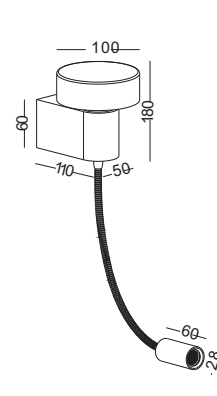





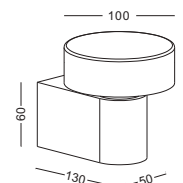
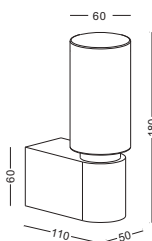
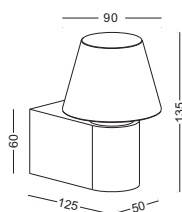

code **LWA207A**  
 casing aluminum / anodized silver  
 lamping cob 5W / Ra>90 / 430LM  
 Beam acrylic diffuser /  
 2700K/3000K/4000K/6000K  
 installation

With switch on the base

surface customizable

- anodized gold brushed circular
- black paint equal to RAL9011
- white paint similar to RAL9003

code **LWA208A**  
 casing aluminum / anodized silver  
 lamping cob 5W / Ra>90 / 430LM  
 Beam acrylic diffuser /  
 2700K/3000K/4000K/6000K  
 installation

With switch on the base

surface customizable

- anodized gold brushed circular
- black paint equal to RAL9011
- white paint similar to RAL9003

code **LWA209A**  
 casing aluminum / anodized silver  
 lamping cob 5W / Ra>90 / 430LM  
 Beam acrylic diffuser /  
 2700K/3000K/4000K/6000K  
 installation

With switch on the base

surface customizable

- anodized gold brushed circular
- black paint equal to RAL9011
- white paint similar to RAL9003





LED

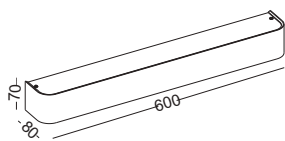

BATHROOM

LIGHT





code **LWA151-SL**  
casing Aluminum / anodized silver  
lamping LED 20W / Ra>80 / 2000LM  
Beam up and down light /  
2700K/~~3000K~~/4000K/6000K  
installation     IP20

surface customizable  black paint  
equal to RAL9011  
 white paint  
similar to RAL9003  
 concrete grey paint  
similar to RAL7037

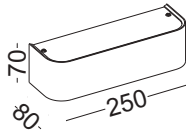

code **LWA 149-SL**

casing Aluminum / anodized silver

lamping LED 8W / Ra>80 / 800LM

Beam up and down light /

2700K/3000K/4000K/6000K

installation     IP20

surface customizable  black paint equal to RAL9011

 white paint similar to RAL9003

 concrete grey paint similar to RAL7037

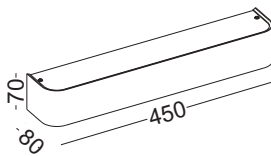

code **LWA 150-SL**

casing Aluminum / anodized silver

lamping LED 12W / Ra>80 / 1200LM

Beam up and down light /

2700K/3000K/4000K/6000K

installation     IP20

surface customizable  black paint equal to RAL9011

 white paint similar to RAL9003

 concrete grey paint similar to RAL7037



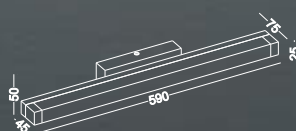

code **LWA196**  
 casing Aluminum / anodized black  
 lamping LED 12W / Ra>80 / 840LM  
 Beam acrylic diffuser /  
 2700K/3000K/4000K/6000K  
 installation   IP20

surface customizable  anodized silver  
 brushed linear  
 white paint  
 similar to RAL9003  
 concrete grey paint  
 similar to RAL7037

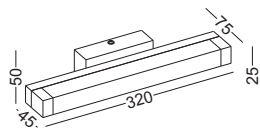

code **LWA 195**  
casing Aluminum / anodized silver  
lamping LED 6W / Ra>80 / 420LM  
Beam acrylic diffuser /  
2700K/~~3000K~~/4000K/6000K  
installation     IP20

surface customizable  anodized silver brushed linear  
 white paint similar to RAL9003  
 concrete grey paint similar to RAL7037







code **LWA237**  
 casing Aluminum / chrome plated  
 lamping LED 3x3W / Ra>80 / 360LM  
 Beam acrylic diffuser /  
 2700K/**3000K**/4000K/6000K  
 installation

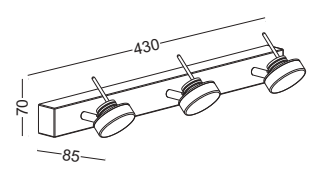

surface customizable black paint equal to RAL9011  
 white paint similar to RAL9003  
 concrete grey paint similar to RAL7037



code **LWA238**  
 casing Aluminum / chrome plated  
 lamping LED 4x3W / Ra>80 / 480LM  
 Beam acrylic diffuser /  
 2700K/**3000K**/4000K/6000K  
 installation

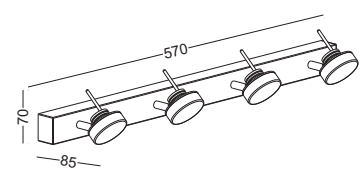

surface customizable black paint equal to RAL9011  
 white paint similar to RAL9003  
 concrete grey paint similar to RAL7037



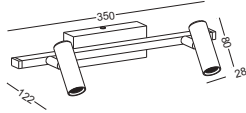

code **LWA189**  
 casing Aluminum / anodized black  
 lamping LED 2x3W / Ra>80 / 240LM  
 Beam 30 degree /  
 2700K/3000K/4000K/6000K  
 installation IP20

surface customizable anodized silver sandblasted

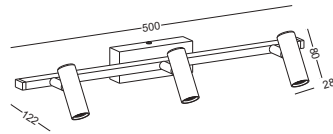

code **LWA190**  
 casing Aluminum / anodized black  
 lamping LED 3x3W / Ra>80 / 360LM  
 Beam 30 degree /  
 2700K/3000K/4000K/6000K  
 installation IP20

surface customizable anodized silver sandblasted

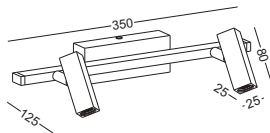

code **LWA191**  
 casing Aluminum / anodized black  
 lamping LED 2x3W / Ra>80 / 240LM  
 Beam 30 degree /  
 2700K/3000K/4000K/6000K  
 installation IP20

surface customizable anodized silver sandblasted

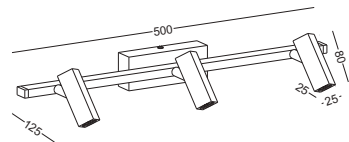

code **LWA192**  
 casing Aluminum / anodized black  
 lamping LED 3x3W / Ra>80 / 360LM  
 Beam 30 degree /  
 2700K/3000K/4000K/6000K  
 installation IP20

surface customizable anodized silver sandblasted



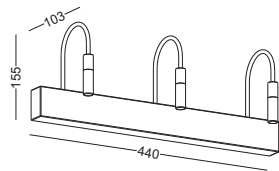

code **LWA235**  
 casing steel / chrome plated  
 lamping LED 3x1W / Ra>80 /210LM  
 Beam acrylic diffuser /  
 2700K/3000K/4000K/6000K  
 installation IP20

surface customizable black point equal to RAL9011  
 white point similar to RAL9003  
 concrete grey paint similar to RAL7037

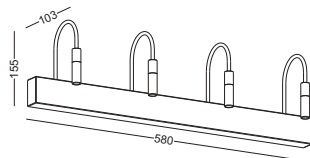

code **LWA236**  
 casing steel / chrome plated  
 lamping LED 4x1W / Ra>80 /280LM  
 Beam acrylic diffuser /  
 2700K/3000K/4000K/6000K  
 installation IP20

surface customizable black point equal to RAL9011  
 white point similar to RAL9003  
 concrete grey paint similar to RAL7037

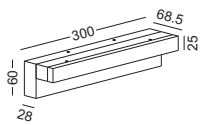

code **LWA285**  
 casing Aluminum / chrome plated  
 lamping LED 6W / Ra>80 / 600LM  
 Beam acrylic diffuser /  
 2700K/3000K/4000K/6000K  
 installation

surface customizable black paint equal to RAL9011  
 white paint similar to RAL9003  
 concrete grey paint similar to RAL7037

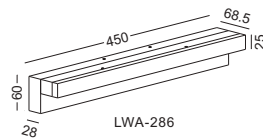

code **LWA286**  
 casing Aluminum / chrome plated  
 lamping LED 6W / Ra>80 / 600LM  
 Beam acrylic diffuser /  
 2700K/3000K/4000K/6000K  
 installation

surface customizable black paint equal to RAL9011  
 white paint similar to RAL9003  
 concrete grey paint similar to RAL7037

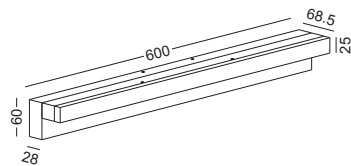

code **LWA287**  
 casing Aluminum / chrome plated  
 lamping LED 10W / Ra>80 / 1000LM  
 Beam acrylic diffuser /  
 2700K/3000K/4000K/6000K  
 installation

surface customizable black paint equal to RAL9011  
 white paint similar to RAL9003  
 concrete grey paint similar to RAL7037





LED PENDA

NT LIGHTS



code **HLO12-WT**

surface customizable



chrome plated



concrete grey paint  
similar to RAL7037



anodized gold  
brushed circular

casing aluminum / white painting / lamping LED 3W / Ra>80 / 120LM / Beam 30 degree / 2700K/3000K/4000K/6000K

installation     IP20 lamp shade dia28mm x 500mm 1meter cable / cable length customizable



code **HLO12-BK**

surface customizable



chrome plated



concrete grey paint similar to RAL7037



anodized gold brushed circular

casing aluminum / black painting / lamping LED 3W / Ra>80 / 120LM / Beam 30 degree / 2700K/~~3000K~~/4000K/6000K

installation     IP20 lamp shade dia28mm x 500mm 1meter cable / cable length customizable













code LPL045-BK

surface customizable



chrome plated



concrete grey paint similar to RAL7037



anodized gold brushed linear

casing aluminum / black painting / lamping LED 3W / Ra>80 / 120LM / Beam 30 degree / 2700K / 3000K / 4000K / 6000K

installation     IP20 lamp shade 25x25mm x 350mm 1meter cable / cable length customizable



code **LPL045-WT**

surface customizable



chrome plated



concrete grey paint similar to RAL7037



anodized gold brushed linear

casing aluminum / white painting /

lamping LED 3W / Ra>80 / 120LM / Beam 30 degree / 2700K/3000K/4000K/6000K

installation     IP20

lamp shade 25x25mm x 350mm 1meter cable / cable length customizable





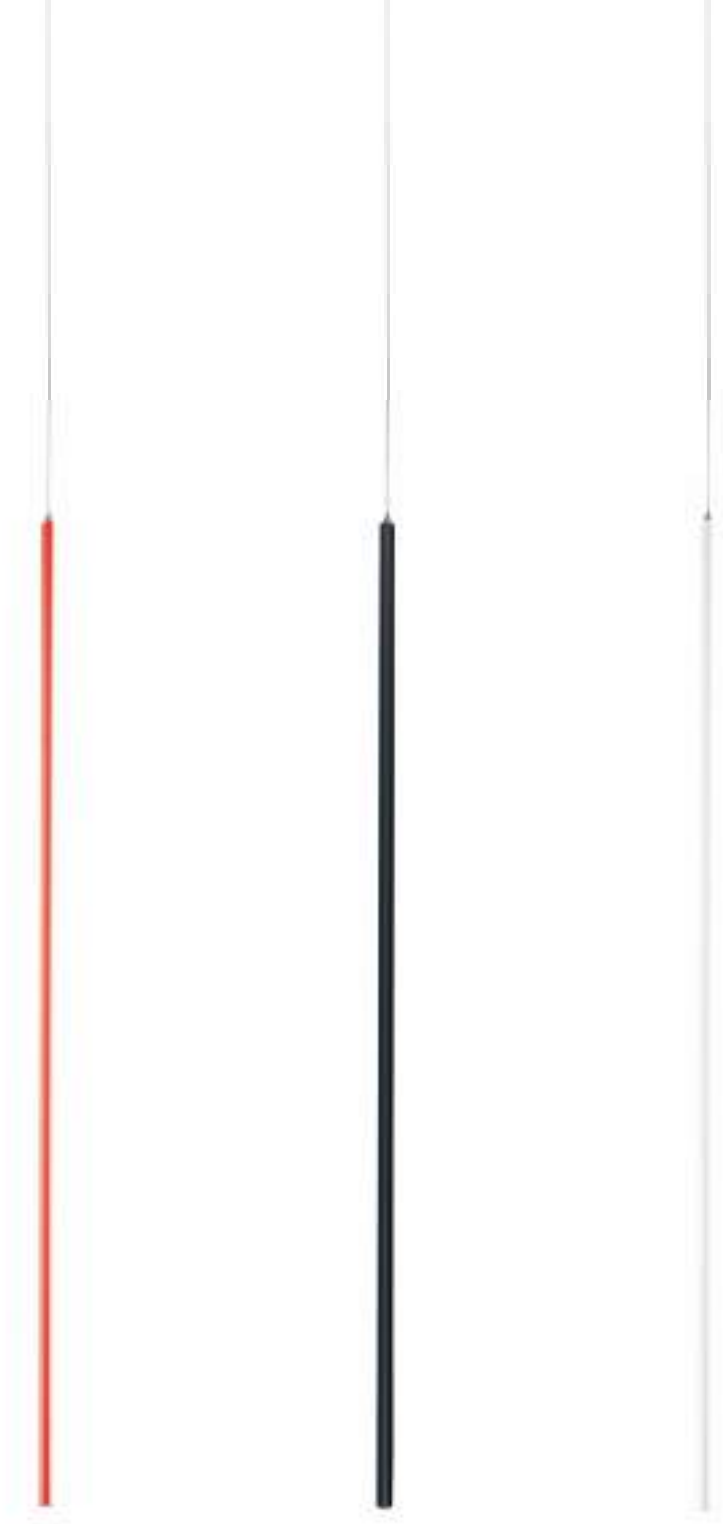

code [LPL201-RD](#) / [LPL201-BK](#) / [LPL201-WT](#)

casing aluminum / red/black/white painting / lamping LED 1W / Ra>80 / 70LM / Beam 30 degree / 2700K/~~3000K~~/4000K/6000K

installation     IP20 lamp shade dia 16mm x 1100mm 1meter cable / cable length customizable

surface  
customizable

 chrome plated

 concrete grey paint  
similar to RAL7037

 anodized gold  
brushed linear









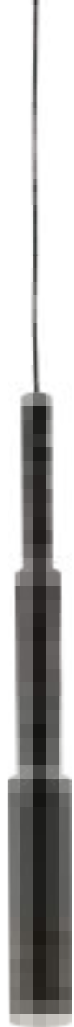

LPL149

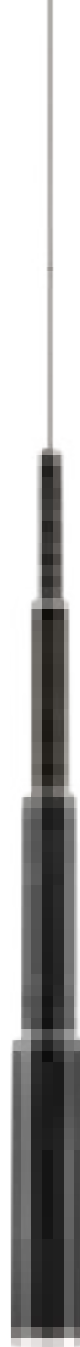

LPL151



LPL150

---

code [LPL149](#)





casing aluminum / anodized black / lamping LED 3W / Ra>80 / 210LM / Beam 30 degree / 2700K/~~3000K~~/4000K/6000K

installation     IP20 lamp shade dia38mm x 385mm 1meter cable / cable length customizable

---

code [LPL150](#)

casing aluminum / anodized black / lamping LED 6W / Ra>80 / 420LM / Beam 30 degree / 2700K/~~3000K~~/4000K/6000K

installation     IP20 lamp shade dia54mm x 635mm 1meter cable / cable length customizable

---

code [LPL151](#)

casing aluminum / anodized black / lamping LED 9W / Ra>80 / 630LM / Beam 30 degree / 2700K/~~3000K~~/4000K/6000K

installation     IP20 lamp shade dia70mm x 920mm 1meter cable / cable length customizable

---







---

code [LPL264-BK](#) / [LPL264-CR](#) / [LPL264-WT](#)

surface  
customizable

■ concrete grey paint  
similar to RAL7037

casing Steel tube / black/chrome/white painting / lamping cob 5W / Ra>90 / 430LM / acrylic diffuser / 2700K/~~3000K~~/4000K/6000K

installation     IP20 lamp shade dia40mm x 500mm 1meter cable / cable length customizable

---



---

code LPL226-CR / LPL226-BK / LPL226-WT

surface customizable  concrete grey paint similar to RAL7037

casing steel tube / chrome/black/white painting / lamping LED 3W / Ra>80 / 120LM / 30 degree / 2700K/~~3000K~~/4000K/6000K

installation     IP20 lamp shade dia40mm x 500mm 1meter cable / cable length customizable

---







---

code **LPL274-BK / LPL264-WT**

surface customizable  concrete grey paint similar to RAL7037

casing Steel tube and shade / black/white painting / lamping cob 5W / Ra>90 /430LM / acrylic diffuser / 2700K/**3000K**/4000K/6000K

installation     IP20 lamp shade dia 160mm x 580mm 1meter cable / cable length customizable

---







LPL152-BK



LPL153-BK



LPL152-WT



LPL 155-BK



LPL 155-WT



LPL 154-BK



LPL 153-WT

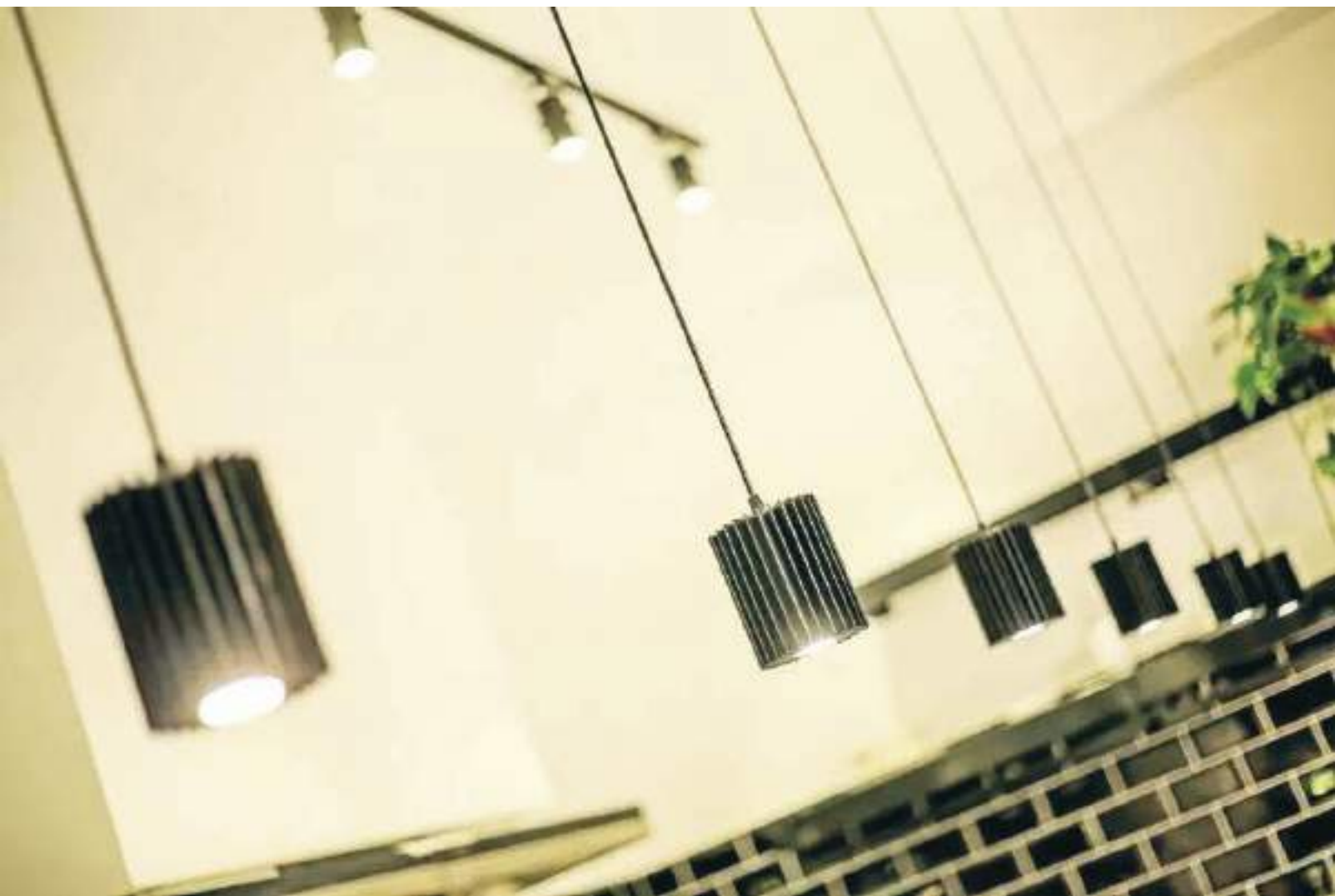





code [LPL152-BK](#)

casing aluminum / anodized black / lamping LED 6W / Ra>80 / 420LM / Beam 30 degree / 2700K/~~3000K~~/4000K/6000K

installation     IP20 lamp shade dia 100mm x 300mm 1meter cable / cable length customizable

---

code [LPL152-WT](#)

casing aluminum / plated white / lamping LED 6W / Ra>80 / 420LM / Beam 30 degree / 2700K/~~3000K~~/4000K/6000K

installation     IP20 lamp shade dia 100mm x 300mm 1meter cable / cable length customizable

---

code [LPL153-BK](#)

casing aluminum / anodized black / lamping LED 6W / Ra>80 / 420LM / Beam 30 degree / 2700K/~~3000K~~/4000K/6000K

installation     IP20 lamp shade dia 100mm x 300mm 1meter cable / cable length customizable

---

code [LPL153-WT](#)

casing aluminum / plated white / lamping LED 6W / Ra>80 / 420LM / Beam 30 degree / 2700K/~~3000K~~/4000K/6000K

installation     IP20 lamp shade dia 100mm x 300mm 1meter cable / cable length customizable

---

code [LPL154-BK](#)

casing aluminum / anodized black / lamping LED 6W / Ra>80 / 420LM / Beam 30 degree / 2700K/~~3000K~~/4000K/6000K

installation     IP20 lamp shade dia 100mm x 300mm 1meter cable / cable length customizable

---

code [LPL154-WT](#)

casing aluminum / plated white / lamping LED 6W / Ra>80 / 420LM / Beam 30 degree / 2700K/~~3000K~~/4000K/6000K

installation     IP20 lamp shade dia 100mm x 300mm 1meter cable / cable length customizable

---

code [LPL155-BK](#)

casing aluminum / anodized black / lamping LED 6W / Ra>80 / 420LM / Beam 30 degree / 2700K/~~3000K~~/4000K/6000K

installation     IP20 lamp shade dia 100mm x 300mm 1meter cable / cable length customizable

---

code [LPL155-WT](#)

casing aluminum / plated white / lamping LED 6W / Ra>80 / 420LM / Beam 30 degree / 2700K/~~3000K~~/4000K/6000K

installation     IP20 lamp shade dia 100mm x 120mm 1meter cable / cable length customizable

---



LPL287-BK



LPL288-BK



LPL286-BK



LPL290-BK

code **LPL286-BK / LPL286-WT**

surface customizable



chrome plated



concrete grey paint similar to RAL7037



anodized gold brushed linear

casing aluminum / black/white painting / lamping COB 5W / Ra>90 / 430LM / Beam 10/23/38 degree / 2700K/3000K/4000K/6000K

installation     IP20 lamp shade dia 60mm x 75mm 2meter cable / cable length customizable

code **LPL287-BK / LPL287-WT**

surface customizable



chrome plated



concrete grey paint similar to RAL7037



anodized gold brushed linear

casing aluminum / black/white painting / lamping COB 5W / Ra>90 / 430LM / Beam 10/23/38 degree / 2700K/3000K/4000K/6000K

installation     IP20 lamp shade dia 65mm x 75mm 2meter cable / cable length customizable



LPL290-WT



LPL287-WT



LPL286-WT



LPL288-WT

code [LPL288-BK](#) / [LPL288-WT](#)

surface customizable



chrome plated



concrete grey paint similar to RAL7037



anodized gold brushed linear

casing aluminum / black/white painting / lamping COB 5W / Ra>90 / 430LM / Beam 10/23/38 degree / 2700K/3000K/4000K/6000K

installation IP20 lamp shade dia 75mm x 80mm 2meter cable / cable length customizable

code [LPL290-BK](#) / [LPL290-WT](#)

surface customizable



chrome plated



concrete grey paint similar to RAL7037



anodized gold brushed linear

casing aluminum / black/white painting / lamping COB 5W / Ra>90 / 430LM / Beam 10/23/38 degree / 2700K/3000K/4000K/6000K

installation IP20 lamp shade dia 68mm x 75mm 2meter cable / cable length customizable



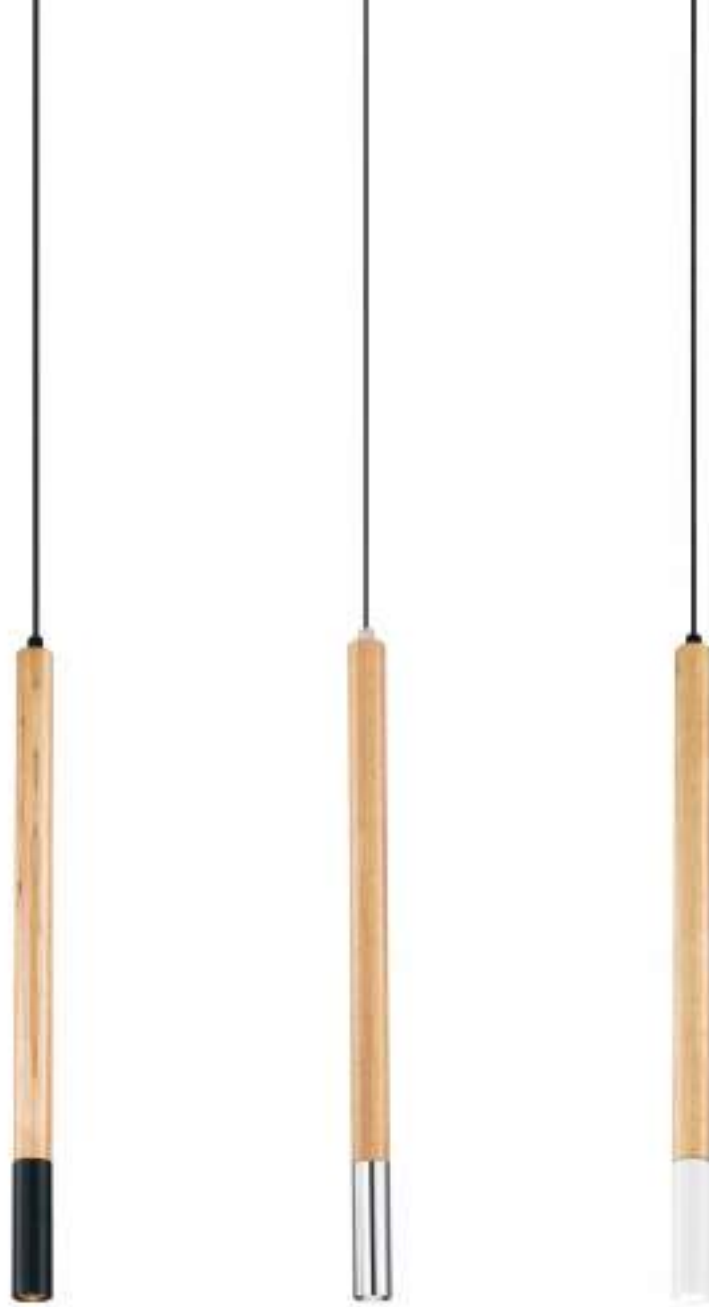

code **LPL268-BK**

surface customizable

■ concrete grey paint similar to RAL7037

casing beech rod and aluminum / anodized black / lamping LED 3W / Ra>80 / 120LM / 30 degree / 2700K/3000K/4000K/6000K

installation     IP20 lamp shade dia28mm x 500mm 1meter cable / cable length customizable

code **LPL268-CR**

surface customizable

■ concrete grey paint similar to RAL7037

casing beech rod and aluminum / Chrome plated / lamping LED 3W / Ra>80 / 120LM / 30 degree / 2700K/3000K/4000K/6000K

installation     IP20 lamp shade dia28mm x 500mm 1meter cable / cable length customizable

code **LPL268-WT**

surface customizable

■ concrete grey paint similar to RAL7037

casing beech rod and aluminum / white painting / lamping LED 3W / Ra>80 / 120LM / 30 degree / 2700K/3000K/4000K/6000K

installation     IP20 lamp shade dia28mm x 500mm 1meter cable / cable length customizable



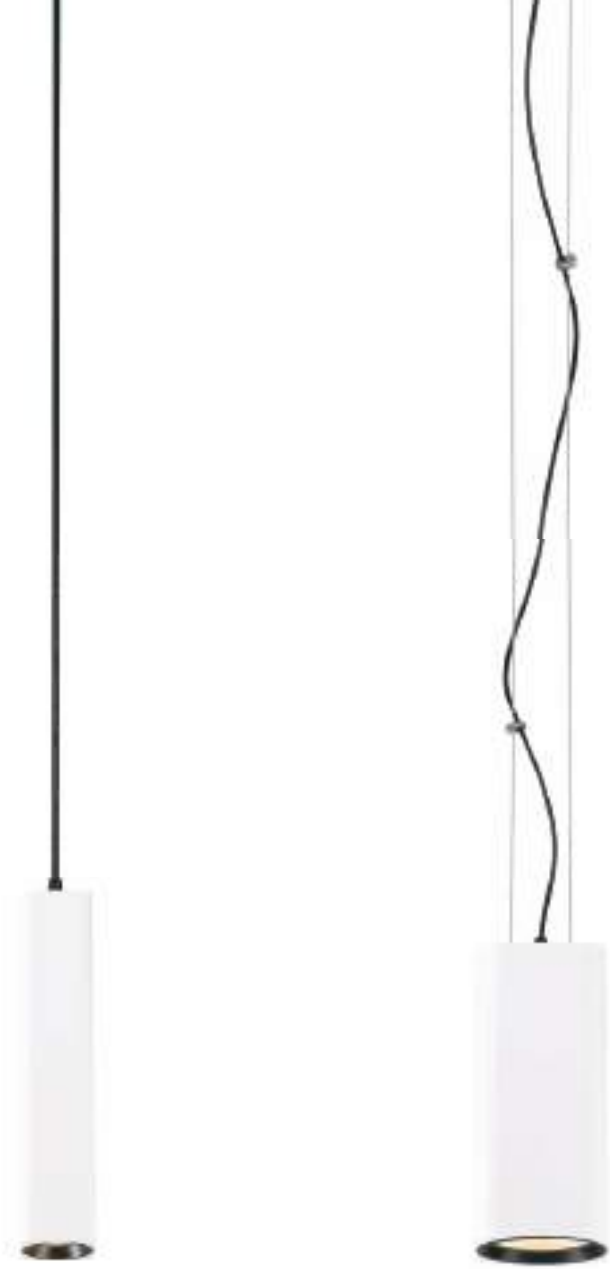

code **LPL262**

surface customizable  black paint equal to RAL9011  concrete grey paint similar to RAL7037

casing aluminum / white painting / lamping COB 5W / Ra>90 / 430LM / 10/23/38 degree / 2700K/3000K/4000K/6000K

installation     IP20 lamp shade 60x60x300mm 1meter cable / cable length customizable

code **LPL263**

surface customizable  black paint equal to RAL9011  concrete grey paint similar to RAL7037

casing aluminum / white painting / lamping COB 12W / Ra>90 / 900LM / 10/23/38 degree / 2700K/3000K/4000K/6000K

installation     IP20 lamp shade 105x105x240mm 1meter cable / cable length customizable



LPL 191



LPL 190

---

code **LPL 190**

surface customizable  black paint equal to RAL9011  white paint similar to RAL9003  concrete grey paint similar to RAL7037

casing aluminum / anodized silver / lamping COB 5W / Ra>90 / 430LM / 15/24/38/60 degree / 2700K/3000K/4000K/6000K

installation     IP20 lamp shade dia 60x230mm 1meter cable / cable length customizable

---

code **LPL 191**

surface customizable  black paint equal to RAL9011  white paint similar to RAL9003  concrete grey paint similar to RAL7037

casing aluminum / anodized silver / lamping COB 12W / Ra>90 / 900LM / 15/24/38/60 degree / 2700K/3000K/4000K/6000K

installation     IP20 lamp shade dia 102x260mm 1meter cable / cable length customizable

---

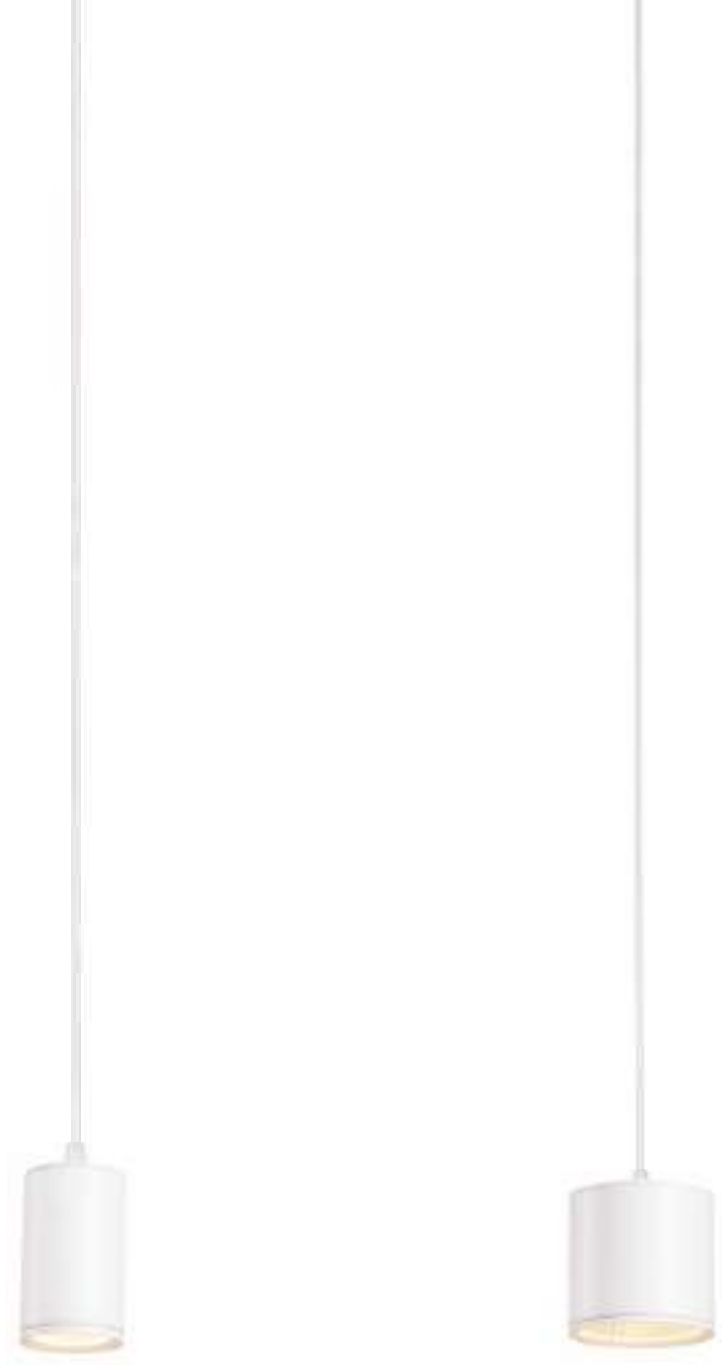

code **LPL 119**

surface customizable  black paint equal to RAL9011  concrete grey paint similar to RAL7037

casing aluminum / white painting / lamping COB 5W / Ra>90 / 430LM / 15/24/38/60 degree / 2700K/3000K/4000K/6000K

installation     IP20 lamp shade dia 60x100mm 1meter cable / cable length customizable

code **LPL 120**

surface customizable  black paint equal to RAL9011  concrete grey paint similar to RAL7037

casing aluminum / white painting / lamping COB 12W / Ra>90 / 900LM / 15/24/38/60 degree / 2700K/3000K/4000K/6000K

installation     IP20 lamp shade dia 102x100mm 1meter cable / cable length customizable

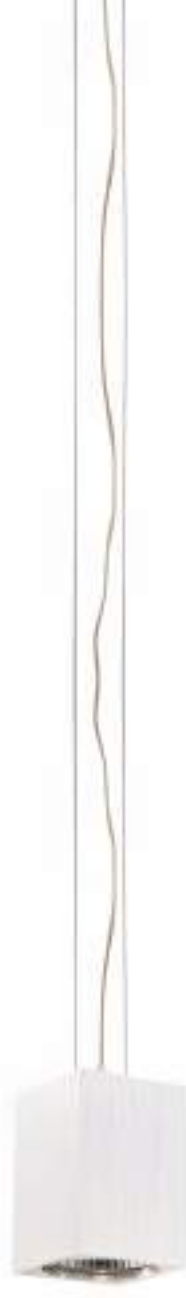

code **LPL185**

surface customizable  black paint equal to RAL9011  white paint similar to RAL9003  concrete grey paint similar to RAL7037

casing aluminum / anodized silver / lamping COB 5W / Ra>90 /430LM / 15/24/38/60 degree / 2700K/3000K/4000K/6000K

installation     IP20 lamp shade 60x60x280mm 1meter cable / cable length customizable

code **LPL186**

surface customizable  black paint equal to RAL9011  white paint similar to RAL9003  concrete grey paint similar to RAL7037

casing aluminum / anodized silver / lamping COB 12W / Ra>90 /900LM / 15/24/38/60 degree / 2700K/3000K/4000K/6000K

installation     IP20 lamp shade 105x105x150mm 1meter cable / cable length customizable

led pendant light  
bracket series



---

code [LPL165-BK](#) / [LPL165-WT](#)

casing aluminum / black/white painting / lamping SMD 6W / Ra>80 / 600LM / acrylic diffuser / 2700K/3000K/4000K/6000K

installation     IP20 lamp shade dia 148mm x 60mm 1meter cable / cable length customizable

---

code [LPL165-CR](#) / [LPL165-GD](#) / [LPL165-SL](#)

casing aluminum / chrome plated / anodized gold / anodized silver

/ lamping SMD 6W / Ra>80 / 600LM / acrylic diffuser / 2700K/3000K/4000K/6000K





installation     IP20 lamp shade dia 148mm x 60mm 1meter cable / cable length customizable

---



code **LPL 166-BK** surface customizable  white paint similar to RAL9003  chrome plated  concrete grey paint similar to RAL7037  anodized gold brushed circular





casing aluminum / black painting / lamping LED 3x4W / Ra>80 / 1200LM / acrylic diffuser / 2700K/~~3000K~~/4000K/6000K

installation     IP20 lamp shade dia 148mm x 60mm 1meter cable / cable length customizable/ 50x30x670mm base



code **LPL 167-BK** surface customizable  white paint similar to RAL9003  chrome plated  concrete grey paint similar to RAL7037  anodized gold brushed circular

casing aluminum / black painting / lamping LED 4x4W / Ra>80 / 1600LM / acrylic diffuser / 2700K/~~3000K~~/4000K/6000K

installation     IP20 lamp shade dia 148mm x 60mm 1meter cable / cable length customizable/ 50x30x955mm base









---

code **LPL 168-BK** surface customizable  white paint similar to RAL9003  chrome plated  concrete grey paint similar to RAL7037  anodized gold brushed circular

casing aluminum / black painting / lamping LED 3x4W / Ra>80 / 1200LM / acrylic diffuser / 2700K/3000K/4000K/6000K

installation     IP20 lamp shade dia 148mm x 60mm 1meter cable / cable length customizable/ 720mm length

---



code **LPL 169-BK**

surface customizable  white paint similar to RAL9003

 chrome plated

 concrete grey paint similar to RAL7037

 anodized gold brushed circular

casing aluminum / black painting / lamping LED 4x4W / Ra>80 / 1600LM / acrylic diffuser / 2700K/3000K/4000K/6000K

installation     IP20 lamp shade dia 148mm x 60mm 1meter cable / cable length customizable/ 1000mm length



code **LPL 170-BK**

surface customizable  white paint similar to RAL9003

 chrome plated

 concrete grey paint similar to RAL7037

 anodized gold brushed circular

casing aluminum / black painting / lamping LED 5x4W / Ra>80 / 2000LM / acrylic diffuser / 2700K/3000K/4000K/6000K

installation     IP20 lamp shade dia 148mm x 60mm 1meter cable / cable length customizable/ 1000mm length





code **LPL187**

surface customizable

 white paint similar to RAL9003

 chrome plated

 concrete grey paint similar to RAL7037

 anodized gold brushed circular

casing aluminum / anodized black / lamping LED 3W / Ra>80 / 120LM / acrylic diffuser / 2700K/**3000K**/4000K/6000K

installation     IP20 lamp shade dia28mm x 500mm 1meter cable / cable length customizable



code **LPL188**

surface customizable

white paint similar to RAL9003

chrome plated

concrete grey paint similar to RAL7037

anodized gold brushed circular

casing aluminum / anodized black / lamping LED 3x3W / Ra>80 / 360LM / acrylic diffuser / 2700K/3000K/4000K/6000K

installation     IP20 lamp shade dia28mm x 500mm 1meter cable / cable length customizable / base 50x30x500mm











LPL174



LPL176

---

code **LPL174** surface customizable  white paint similar to RAL9003  chrome plated  concrete grey paint similar to RAL7037  anodized gold brushed circular

casing aluminum / anodized silver / lamping COB 5W / Ra>90 / 430LM / acrylic diffuser / 2700K/3000K/4000K/6000K

installation     IP20 lamp shade dia 60mm x 157mm 1meter cable / cable length customizable

---

code **LPL176** surface customizable  white paint similar to RAL9003  chrome plated  concrete grey paint similar to RAL7037  anodized gold brushed circular

casing aluminum / anodized silver / lamping COB 5W / Ra>90 / 430LM / acrylic diffuser / 2700K/3000K/4000K/6000K

installation     IP20 lamp shade dia 110mm x 62mm 1meter cable / cable length customizable

---











LPL236



















LPL237



LPL238

code **LPL236** surface customizable  white paint similar to RAL9003  chrome plated  concrete grey paint similar to RAL7037  anodized gold brushed circular  
 casing aluminum / anodized black / lamping COB 5W / Ra>90 / 430LM / acrylic diffuser / 2700K/~~3000K~~/4000K/6000K  
 installation     IP20 lamp shade dia 60mm x 195mm / 1meter cable / cable length customizable

code **LPL237** surface customizable  white paint similar to RAL9003  chrome plated  concrete grey paint similar to RAL7037  anodized gold brushed circular  
 casing aluminum / anodized black / lamping COB 5W / Ra>90 / 430LM / acrylic diffuser / 2700K/~~3000K~~/4000K/6000K  
 installation     IP20 lamp shade dia 80mm x 115mm / 1meter cable / cable length customizable

code **LPL238** surface customizable  white paint similar to RAL9003  chrome plated  concrete grey paint similar to RAL7037  anodized gold brushed circular  
 casing aluminum / anodized black / lamping COB 5W / Ra>90 / 430LM / acrylic diffuser / 2700K/~~3000K~~/4000K/6000K  
 installation     IP20 lamp shade dia 110mm x 70mm / 1meter cable / cable length customizable

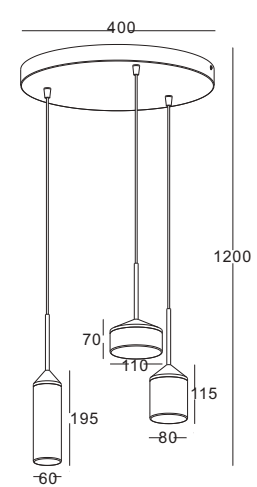



code **LPL239** surface customizable  white paint similar to RAL9003  chrome plated  concrete grey paint similar to RAL7037  anodized gold brushed circular

casing aluminum / anodized black / lamping COB 3x5W / Ra>90 / 1290LM / acrylic diffuser / 2700K/~~3000K~~/4000K/6000K

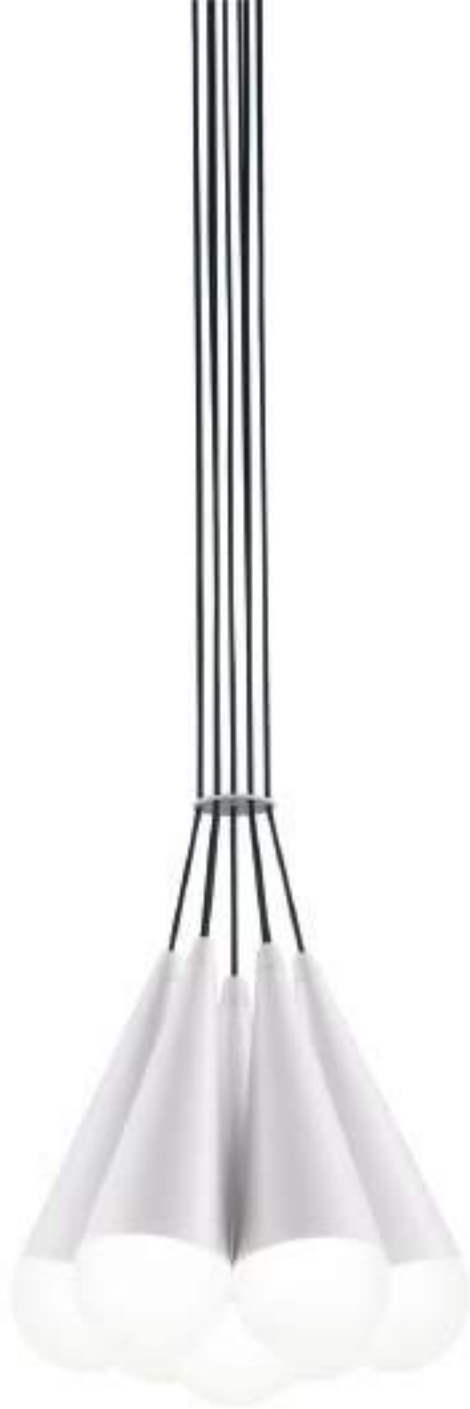
installation IP20 lamp shade as line drawing / 1 meter cable / cable length customizable



code **LPL273**

surface customizable  black paint equal to RAL9011  chrome plated  concrete grey paint similar to RAL7037

casing steel / white painting / lamping SMD 7x6W / Ra>80 / 4200LM / acrylic diffuser / 2700K/**3000K**/4000K/6000K

installation     IP20 lamp shade totally dia320x320mm / 1meter cable / cable length customizable



code **LPL272**

surface customizable



black paint equal to RAL9011



chrome plated



concrete grey paint similar to RAL7037

casing steel / white painting / lamping SMD 3x6W / Ra>80 / 1800LM / acrylic diffuser / 2700K/**3000K**/4000K/6000K

installation IP20 lamp shade totally dia 220x290mm / 1meter cable / cable length customizable

code **LPL271**

surface customizable



black paint equal to RAL9011



chrome plated



concrete grey paint similar to RAL7037

casing steel / white painting / lamping SMD 6W / Ra>80 / 600LM / acrylic diffuser / 2700K/**3000K**/4000K/6000K

installation IP20 lamp shade dia 100x290mm / 1meter cable / cable length customizable



---

code **LPL292-BK**

casing aluminum / anodized black / lamping E27 Socket / bulb not inculed

installation     IP20

lamp shade dia 140x230mm / 1meter cable / cable length customizable

surface customizable

 white paint similar to RAL9003  
 concrete grey paint similar to RAL7037

---

code **LPL292-GD**

casing aluminum / anodized gold / lamping E27 Socket / bulb not inculed

installation     IP20

lamp shade dia 140x230mm / 1meter cable / cable length customizable

surface customizable

 white paint similar to RAL9003  
 concrete grey paint similar to RAL7037

---

code **LPL292-SL**

casing aluminum / anodized silver / lamping E27 Socket / bulb not inculed

installation     IP20

lamp shade dia 140x230mm / 1meter cable / cable length customizable

surface customizable

 white paint similar to RAL9003  
 concrete grey paint similar to RAL7037



code **LPL293-BK**

surface customizable  white paint similar to RAL9003  concrete grey paint similar to RAL7037

casing aluminum / anodized black / lamping SMD 6W / Ra>80 /600LM / Acrylic cover / 2700K/**3000K**/4000K/6000K

installation     IP20 lamp shade dia 140mm x 230mm 1meter cable / cable length customizable

code **LPL293-SL**

surface customizable  white paint similar to RAL9003  concrete grey paint similar to RAL7037

casing aluminum / anodized silver / lamping SMD 6W / Ra>80 /600LM / Acrylic cover / 2700K/**3000K**/4000K/6000K

installation     IP20 lamp shade dia 140mm x 230mm 1meter cable / cable length customizable

code **LPL293-GD**

surface customizable  white paint similar to RAL9003  concrete grey paint similar to RAL7037

casing aluminum / anodized gold / lamping SMD 6W / Ra>80 /600LM / Acrylic cover / 2700K/**3000K**/4000K/6000K

installation     IP20 lamp shade dia 140mm x 230mm 1meter cable / cable length customizable







surface  
customizable

all following color  
can be separately  
used for up and down  
ring shade

-  black paint  
equal to RAL9011
-  white paint  
similar to RAL9003
-  concrete grey paint  
similar to RAL7037
-  anodized silver  
brushed circular

---

code [LPL173-BK](#) / [LPL173-CR](#) / [LPL173-GD](#)

casing aluminum / down ring white painting + up ring black painting / chrome plated / anodized gold / lamping E27 Socket / bulb not inculed

installation     IP20 lamp shade dia148x270mm / 1meter cable / cable length customizable

---



LPL217



LPL215

---

code [LPL217](#)

casing aluminum heat sink and ceramic shade / lamping COB 5W / Ra>90 / 430LM / no reflector / 2700K/~~3000K~~/4000K/6000K

installation     IP20 lamp shade dia 205mm x 100mm 1meter cable / cable length customizable

---

code [LPL215](#)

casing aluminum heat sink and ceramic shade / lamping COB 5W / Ra>90 / 430LM / no reflector / 2700K/~~3000K~~/4000K/6000K

installation     IP20 lamp shade dia 180mm x 100mm 1meter cable / cable length customizable



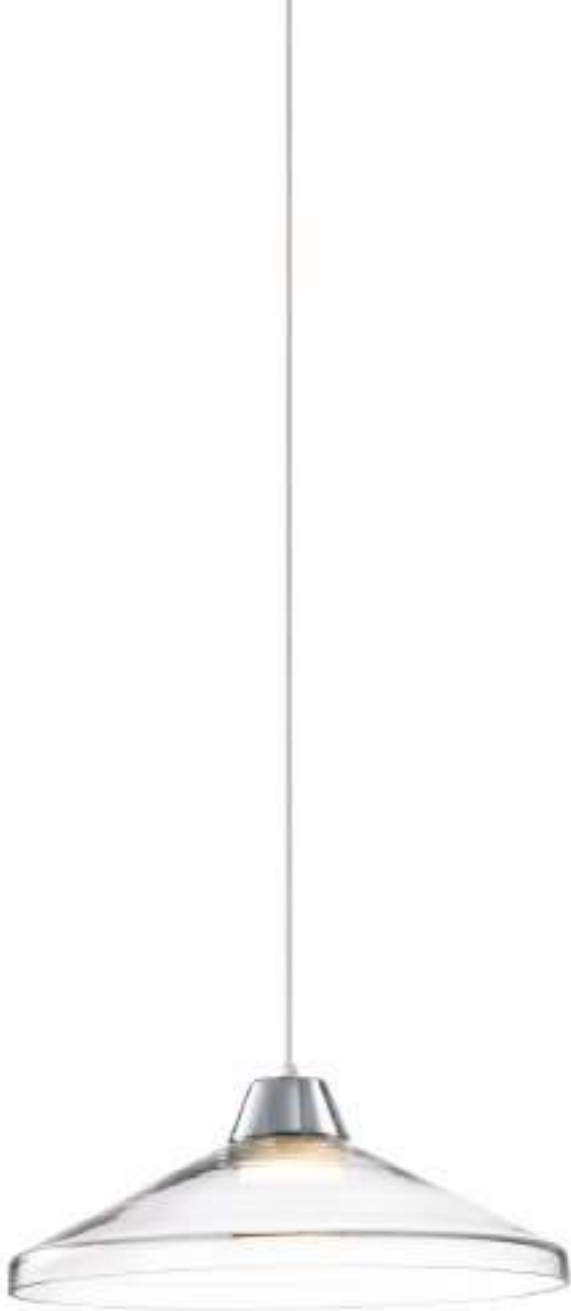

LPL281



LPL279

code **LPL281**

surface customizable

white paint similar to RAL9003

concrete grey paint similar to RAL7037

anodized black sandblasted

casing aluminum heat sink and crystal glass shade / chrome / lamping SMD 4W / Ra>80 / 400LM / acrylic diffuser / 2700K/3000K/4000K/6000K

installation     IP20 lamp shade dia 350mm x 145mm 1meter cable / cable length customizable / check page 001 for line drawing

code **LPL279**

surface customizable

white paint similar to RAL9003

concrete grey paint similar to RAL7037

anodized black sandblasted

casing aluminum heat sink and crystal glass shade / chrome / lamping SMD 10W / Ra>80 / 1000LM / acrylic diffuser / 2700K/3000K/4000K/6000K

installation     IP20 lamp shade dia 220mm x 220mm 1meter cable / cable length customizable / check page 001 for line drawing



LPL280



LPL282

code **LPL280**

surface customizable  white paint similar to RAL9003  concrete grey paint similar to RAL7037  anodized black sandblasted

casing aluminum case and crystal glass shade / chrome / E27 socket / bulb not included /

installation     IP20 lamp shade dia 220mm x 220mm 1meter cable / cable length customizable / check page 001 for line drawing

code **LPL282**

surface customizable  white paint similar to RAL9003  concrete grey paint similar to RAL7037  anodized black sandblasted

casing aluminum case and crystal glass shade / chrome / E27 socket / bulb not included /

installation     IP20 lamp shade dia 350mm x 130mm 1meter cable / cable length customizable / check page 001 for line drawing











code **LPL194**

surface customizable  anodized silver brushed circular  anodized black sandblasted  white paint similar to RAL9003

casing aluminum / chrome plated / lamping LED 20W / Ra>80 / 2000LM / acrylic cover / 2700K/~~3000K~~/4000K/6000K

installation     IP20 lamp shade dia 102mm x H32mm x total 742mm long / 1meter cable / cable length customizable



code **LPL205**

surface customizable  black paint equal to RAL9011  white paint similar to RAL9003  anodized gold sandblasted

casing aluminum / anodized silver / lamping LED 20W / Ra>80 / 2000LM / acrylic diffuser / 2700K/~~3000K~~/4000K/6000K

installation     IP20 lamp shade 120mm x 29mm x 1100mm long / 1meter cable / cable length customizable





LPL 196



LPL 197

code **LPL 196**

surface customizable  black paint equal to RAL9011  white paint similar to RAL9003  anodized silver brushed circular  anodized gold brushed circular

casing aluminum / chrome plated / lamping LED 18W / Ra>80 / 1800LM / acrylic cover / 2700K/**3000K**/4000K/6000K

installation     IP20 lamp shade totally dia 385 mm / 1 meter cable / cable length customizable

code **LPL 197**

surface customizable  black paint equal to RAL9011  white paint similar to RAL9003  anodized silver brushed circular  anodized gold brushed circular

casing aluminum / chrome plated / lamping LED 36W / Ra>80 / 3600LM / acrylic cover / 2700K/**3000K**/4000K/6000K

installation     IP20 lamp shade totally dia 424 mm / 1 meter cable / cable length customizable





code **LPL212-BK**

surface customizable  concrete grey paint similar to RAL7037  anodized silver sandblasted  anodized gold sandblasted

casing aluminum / black painting / lamping LED 12x3W / Ra>80 / 1440LM / acrylic diffuser / 2700K/**3000K**/4000K/6000K

installation     IP20 lamp shade total dia 585mm / 1 meter cable / cable length customizable

---



code **LPL212-WT**

surface customizable  concrete grey paint similar to RAL7037  anodized silver sandblasted  anodized gold sandblasted

casing aluminum / white painting / lamping LED 12x3W / Ra>80 / 1440LM / acrylic diffuser / 2700K/**3000K**/4000K/6000K

installation     IP20 lamp shade total dia 585mm / 1meter cable / cable length customizable

---



code **LPL213-BK**

surface customizable  concrete grey paint similar to RAL7037  anodized silver sandblasted  anodized gold sandblasted

casing aluminum / black painting / lamping LED 24x3W / Ra>80 / 2880LM / acrylic diffuser / 2700K/**3000K**/4000K/6000K

installation     IP20 lamp shade total dia 655mm / 1meter cable / cable length customizable

---





code LPL213-WT

surface customizable  concrete grey paint similar to RAL7037  anodized silver sandblasted  anodized gold sandblasted

casing aluminum / White painting / lamping LED 24x3W / Ra>80 /2880LM / acrylic diffuser / 2700K/3000K/4000K/6000K

installation     IP20 lamp shade total dia 655mm / 1meter cable / cable length customizable







LPL214-BK



LPL214-WT



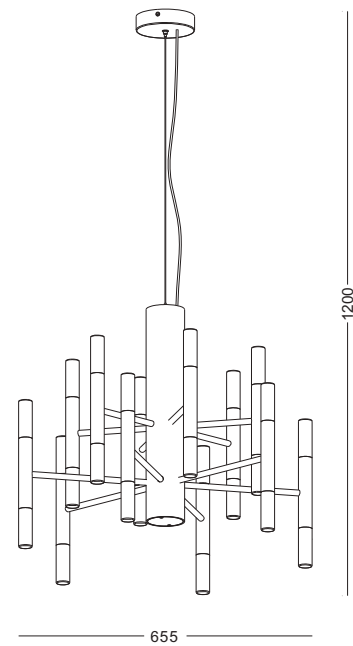
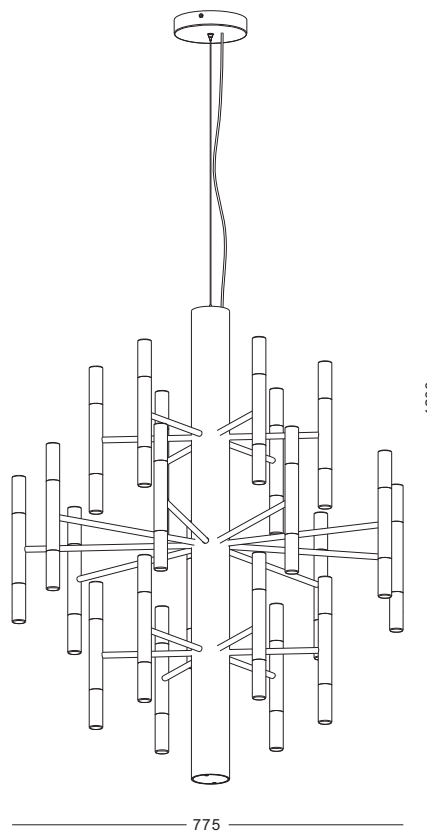
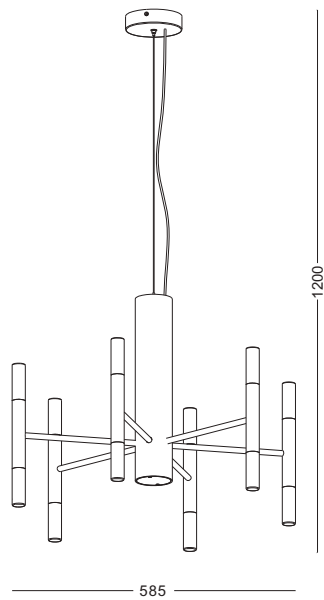

code **LPL214-BK**

surface customizable



concrete grey paint similar to RAL7037



anodized silver sandblasted



anodized gold sandblasted

casing aluminum / black painting / lamping LED 42x3W / Ra>80 / 5040LM / acrylic diffuser / 2700K/3000K/4000K/6000K

installation lamp shade total dia 775mm / 1meter cable / cable length customizable

code **LPL214-WT**

surface customizable



concrete grey paint similar to RAL7037



anodized silver sandblasted



anodized gold sandblasted

casing aluminum / white painting / lamping LED 42x3W / Ra>80 / 5040LM / acrylic diffuser / 2700K/3000K/4000K/6000K

installation lamp shade total dia 775mm / 1meter cable / cable length customizable



code **LPL256**

surface customizable

white paint similar to RAL9003

concrete grey paint similar to RAL7037

anodized gold sandblasted

casing aluminum / black painting / lamping LED 108W / Ra>80 / 10800LM / acrylic cover / 2700K/3000K/4000K/6000K

installation     IP20 Ring dia 659/790/922mm / 1meter cable / cable length customizable







code **LPL252**

surface customizable

white paint similar to RAL9003

concrete grey paint similar to RAL7037

anodized gold sandblasted

casing aluminum / black painting / lamping LED 24W / Ra>80 / 2400LM / acrylic cover / 2700K/3000K/4000K/6000K

installation     IP20 Ring dia 527mm / 1meter cable / cable length customizable

code **LPL253**

surface customizable

white paint similar to RAL9003

concrete grey paint similar to RAL7037

anodized gold sandblasted

casing aluminum / black painting / lamping LED 30W / Ra>80 / 3000LM / acrylic cover / 2700K/3000K/4000K/6000K

installation     IP20 Ring dia 659mm / 1meter cable / cable length customizable



code **LPL254**

surface customizable  white paint similar to RAL9003  concrete grey paint similar to RAL7037  anodized gold sandblasted

casing aluminum / black painting / lamping LED 36W / Ra>80 / 3600LM / acrylic cover / 2700K/**3000K**/4000K/6000K

installation     IP20 Ring dia 790mm / 1meter cable / cable length customizable

code **LPL255**

surface customizable  white paint similar to RAL9003  concrete grey paint similar to RAL7037  anodized gold sandblasted

casing aluminum / black painting / lamping LED 42W / Ra>80 / 4200LM / acrylic cover / 2700K/**3000K**/4000K/6000K

installation     IP20 Ring dia 922mm / 1meter cable / cable length customizable



LPL222



LPL221

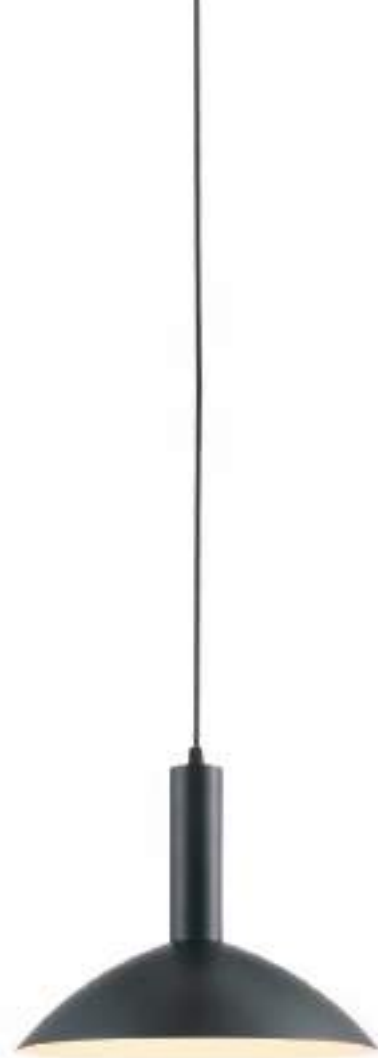

LPL223

code **LPL221**

surface customizable

■ concrete grey paint similar to RAL7037

■ white paint similar to RAL9003

casing aluminum heat sink / steel shade / white paint inside / black paint outside / lamping COB 9W / Ra>90 / 800LM / acrylic diffuser inside / 2700K/3000K/4000K/6000K

installation IP20 lamp shade dia 250 mm x 200mm 1meter cable / cable length customizable

code **LPL222**

surface customizable

■ concrete grey paint similar to RAL7037

■ white paint similar to RAL9003

casing aluminum heat sink / steel shade / white paint inside / black paint outside / lamping COB 9W / Ra>90 / 800LM / acrylic diffuser inside / 2700K/3000K/4000K/6000K

installation IP20 lamp shade dia 200 mm x 180mm 1meter cable / cable length customizable

code **LPL223**

surface customizable

■ concrete grey paint similar to RAL7037

■ white paint similar to RAL9003

casing aluminum heat sink / steel shade / white paint inside / black paint outside / lamping COB 9W / Ra>90 / 800LM / acrylic diffuser inside / 2700K/3000K/4000K/6000K

installation IP20 lamp shade dia 300 mm x 90mm 1meter cable / cable length customizable



LPL164

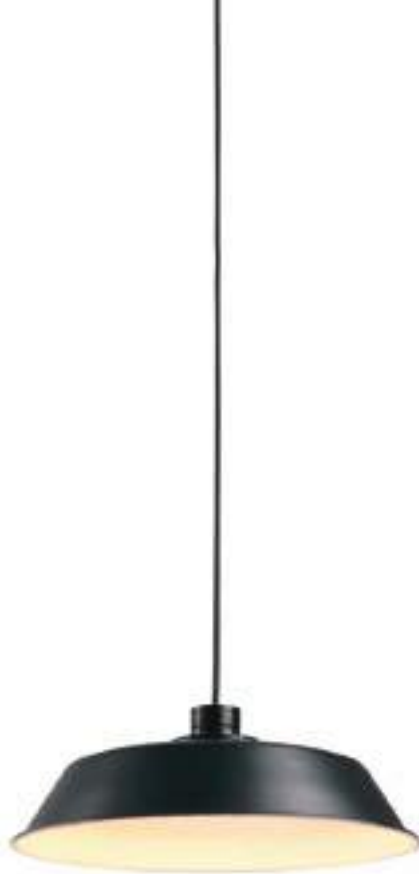

LPL162

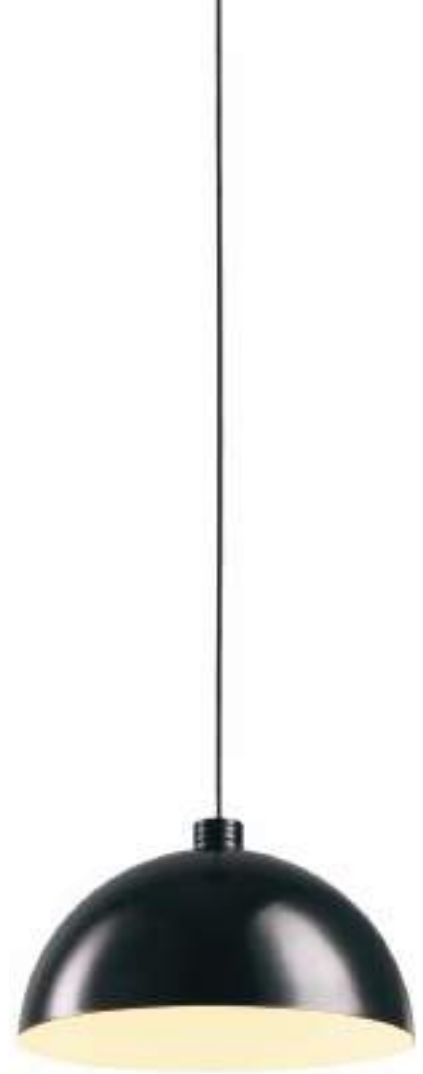

LPL163

code **LPL162**

surface customizable  concrete grey paint similar to RAL7037  white paint similar to RAL9003

casing aluminum heat sink / white paint inside / lamping COB 9W / Ra>90 / 800LM / acrylic cover inside / 2700K/3000K/4000K/6000K  
steel shade / black paint outside

installation     IP20 lamp shade dia 360 mm x 95mm 1meter cable / cable length customizable

code **LPL163**

surface customizable  concrete grey paint similar to RAL7037  white paint similar to RAL9003

casing aluminum heat sink / white paint inside / lamping COB 9W / Ra>90 / 800LM / acrylic cover inside / 2700K/3000K/4000K/6000K  
steel shade / black paint outside

installation     IP20 lamp shade dia 350 mm x 173mm 1meter cable / cable length customizable

code **LPL164**

surface customizable  concrete grey paint similar to RAL7037  white paint similar to RAL9003

casing aluminum heat sink / white paint inside / lamping COB 9W / Ra>90 / 800LM / acrylic cover inside / 2700K/3000K/4000K/6000K  
steel shade / black paint outside

installation     IP20 lamp shade dia 270 mm x 185mm 1meter cable / cable length customizable



code **LPL172-GD**

surface customizable  concrete grey paint similar to RAL7037  white paint similar to RAL9003

casing aluminum heat sink / gold plated steel shade / stainless steel reflector / lamping COB 5W / Ra>90 / 430LM / acrylic diffuser / 2700K/3000K/4000K/6000K

installation     IP20 lamp shade dia 380 mm / 1meter cable / cable length customizable

code **LPL172-RG**

surface customizable  concrete grey paint similar to RAL7037  white paint similar to RAL9003

casing aluminum heat sink / rose gold plated steel shade / stainless steel reflector / lamping COB 5W / Ra>90 / 430LM / acrylic diffuser / 2700K/3000K/4000K/6000K

installation     IP20 lamp shade dia 380 mm / 1meter cable / cable length customizable

code **LPL172-CR**

surface customizable  concrete grey paint similar to RAL7037  white paint similar to RAL9003

casing aluminum heat sink / chrome plated steel shade / stainless steel reflector / lamping COB 5W / Ra>90 / 430LM / acrylic diffuser / 2700K/3000K/4000K/6000K

installation     IP20 lamp shade dia 380 mm / 1meter cable / cable length customizable



code **LPL171-GD**

surface customizable  concrete grey paint similar to RAL7037  white paint similar to RAL9003

casing aluminum heat sink / gold plated steel shade / stainless steel reflector / lamping COB 5W / Ra>90 / 430LM / acrylic diffuser / 2700K/3000K/4000K/6000K

installation IP20 lamp shade dia 380 mm / 1meter cable / cable length customizable

code **LPL171-RG**

surface customizable  concrete grey paint similar to RAL7037  white paint similar to RAL9003

casing aluminum heat sink / rose gold plated steel shade / stainless steel reflector / lamping COB 5W / Ra>90 / 430LM / acrylic diffuser / 2700K/3000K/4000K/6000K

installation IP20 lamp shade dia 380 mm / 1meter cable / cable length customizable

code **LPL171-CR**

surface customizable  concrete grey paint similar to RAL7037  white paint similar to RAL9003

casing aluminum heat sink / chrome plated steel shade / stainless steel reflector / lamping COB 5W / Ra>90 / 430LM / acrylic diffuser / 2700K/3000K/4000K/6000K

installation IP20 lamp shade dia 380 mm / 1meter cable / cable length customizable



code LPL172-BK / LPL172-WT

casing aluminum heat sink / steel shade black / white paint / for outside and white paint / lamping COB 5W / Ra>90 / 430LM / acrylic diffuser / 2700K/3000K/4000K/6000K

installation     IP20 lamp shade dia 380 mm / 1meter cable / cable length customizable

surface customizable  concrete grey paint similar to RAL7037

code LPL172-RD / LPL172-YW / LPL172-GN

casing aluminum heat sink / steel shade red / yellow / green paint / for outside and white paint / lamping COB 5W / Ra>90 / 430LM / acrylic diffuser / 2700K/3000K/4000K/6000K

installation     IP20 lamp shade dia 380 mm / 1meter cable / cable length customizable

surface customizable  concrete grey paint similar to RAL7037



code LPL171-BK / LPL171-WT

casing aluminum heat sink / steel shade black / white paint / for outside and white paint / lamping COB 5W / Ra>90 / 430LM / acrylic diffuser / 2700K/3000K/4000K/6000K

installation     IP20 lamp shade dia 380 mm / 1meter cable / cable length customizable

surface customizable  concrete grey paint similar to RAL7037

code LPL171-RD / LPL171-YW / LPL172-GN

casing aluminum heat sink / steel shade red / yellow / green paint / for outside and white paint / lamping COB 5W / Ra>90 / 430LM / acrylic diffuser / 2700K/3000K/4000K/6000K

installation     IP20 lamp shade dia 380 mm / 1meter cable / cable length customizable

surface customizable  concrete grey paint similar to RAL7037





Cone -shape base with no installation nuts outside makes the whole lamp harmonious



Spot light inside the cone makes this series unique it becomes a hanging spotlight when people thinks it is diffused

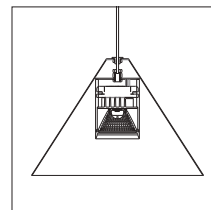

It has a perfect structure with no any screw or nuts outside the lamp the whole design looks so harmonius

code **LPL227-WT / LPL227-GR / LPL227-BK**

casing aluminum heat sink / white / grey / black / steel shade / lamping COB 5W / Ra>90 / 430LM / 10/23/38 degree / 2700K/3000K/4000K/6000K

installation     IP20 lamp shade dia 250 mm x 153mm 1meter cable / cable length customizable



BIGGER VERSION  
DIA 310MM  
FOR LPL227 SERIES



Cone -shape base with no installation nuts outside makes the whole lamp harmonious



Spot light inside the cone makes this series unique it becomes a hanging spotlight when people thinks it is diffused

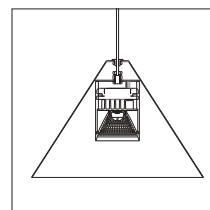

It has a perfect structure with no any screw or nuts outside the lamp the whole design looks so harmonius

code LPL228-WT / LPL228-GR / LPL228-BK

casing aluminum heat sink / white / grey / black / steel shade inside and outside / lamping COB 9W / Ra>90 / 800LM / 10/23/38 degree / 2700K/3000K/4000K/6000K

installation     IP20 lamp shade dia 310 mm x 213mm 1meter cable / cable length customizable

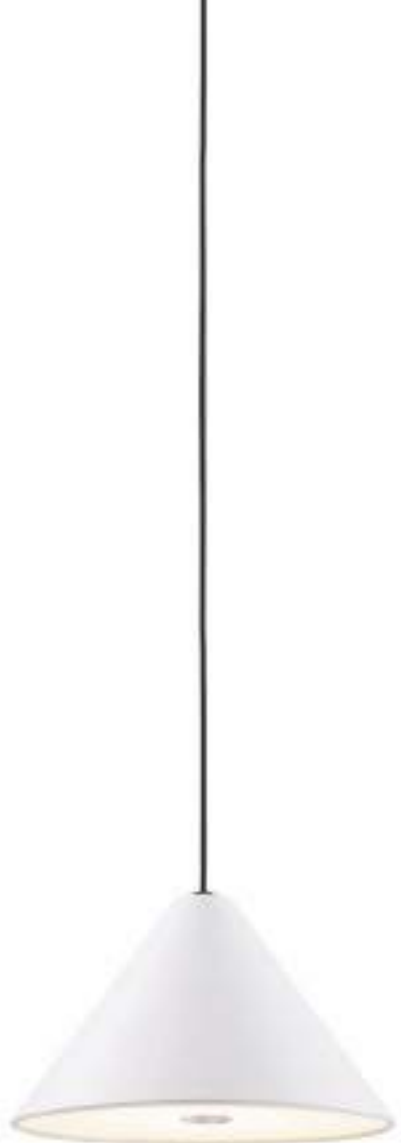
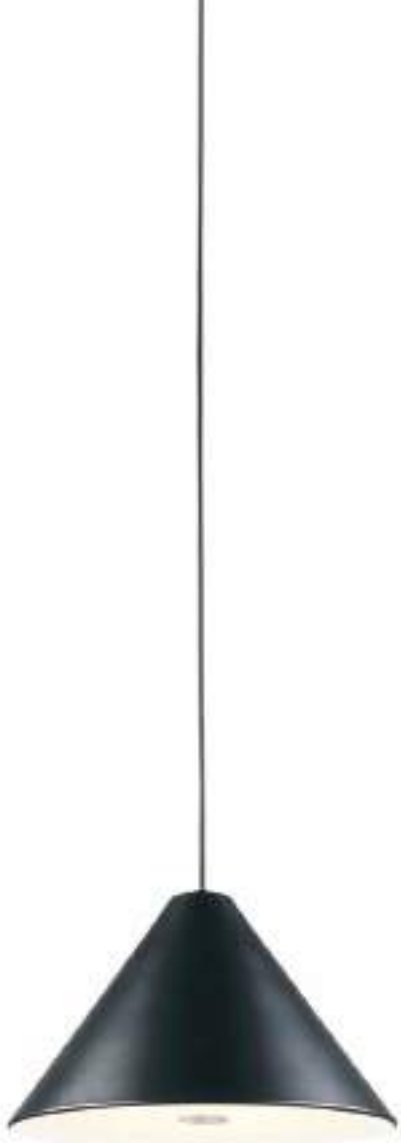

Cone -shape base with no installation nuts outside makes the whole lamp harmonious



With a little aluminum piece the acrylic cover installed on the cape diffuses the light soft and even

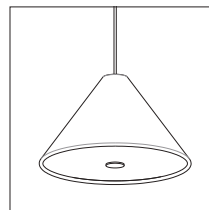

It has a perfect structure with no any screw or nuts outside the lamp the whole design looks so harmonius

code **LPL298-BK / LPL298-WT**

casing aluminum heat sink / black / white paint steel shade inside and outside

installation     IP20

lamp shade dia 250 mm x 153mm 1meter cable / cable length customizable

surface customizable

 concrete grey paint similar to RAL7037

/ lamping SMD 10W / Ra>80 / 1000LM / acrylic diffuser / 2700K/3000K/4000K/6000K



Cone -shape base with no installation nuts outside makes the whole lamp harmonious



With a little aluminum piece the acrylic cover installed on the cape diffuses the light soft and even

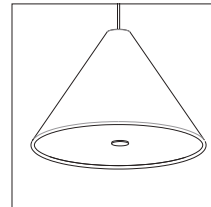

It has a perfect structure with no any screw or nuts outside the lamp the whole design looks so harmonius

code **LPL299-WT / LPL299-BK**

casing aluminum heat sink / white / black paint steel shade inside and outside

installation     IP20

lamp shade dia 310 mm x 213mm 1meter cable / cable length customizable

surface customizable

 concrete grey paint similar to RAL7037

/ lamping SMD 18W / Ra>80 / 1800LM / acrylic diffuser / 2700K/3000K/4000K/6000K



RELATED  
PRODUCTS  
IN THIS SERIES



Wall type  
in white  
LWA318-WT



Wall type  
in grey  
LWA318-GR



Ceiling type  
in white  
LBL231-WT



Ceiling type  
in grey  
LBL231-GR

code **LPL312-WT**

casing aluminum heat sink / steel sheet / white paint / lamping SMD 18W+cob 9w downlight / Ra>80 / 1800+800LM / 10/23/38 degree / 2700K/3000K/4000K/6000K

installation     IP20 lamp sheet Max dia 550 mm / 1meter cable / cable length customizable

surface customizable  black paint equal to RAL9011



RELATED  
PRODUCTS  
IN THIS SERIES



Wall type  
in white  
LWA318-WT



Wall type  
in grey  
LWA318-GR



Ceiling type  
in white  
LBL231-WT



Ceiling type  
in grey  
LBL231-GR

code **LPL312-GR**

casing aluminum heat sink / steel sheet / grey paint / lamping SMD 18W+cob 9w downlight / Ra>80 / 1800+800LM / 10/23/38 degree / 2700K/3000K/4000K/6000K

installation     IP20 lamp sheet Max dia 550 mm / 1meter cable / cable length customizable

surface customizable  black paint equal to RAL9011

# LED PENDANT MEASUREMENTS

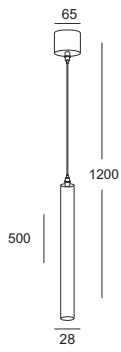

HL012

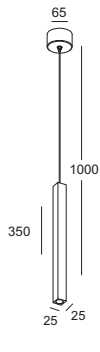

LPL045



LPL201

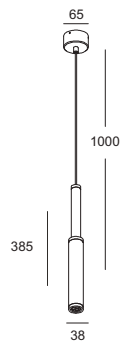

LPL149

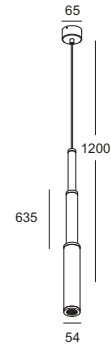

LPL150

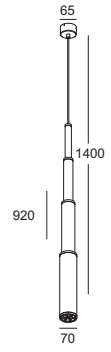

LPL151



LPL264



LPL226

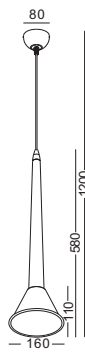

LPL274

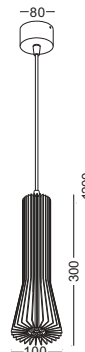

LPL152



LPL153



LPL154

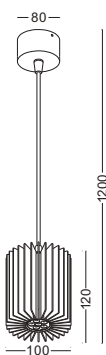

LPL155

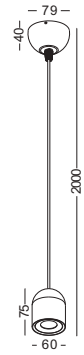

LPL286

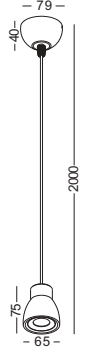

LPL287



LPL288



LPL290

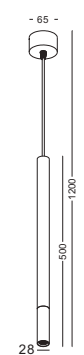

LPL268

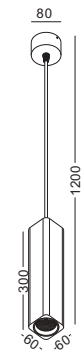

LPL262

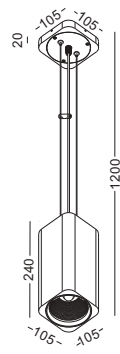

LPL263

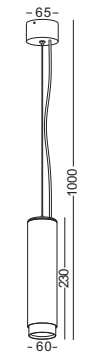

LPL190

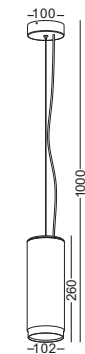

LPL191



LPL119



LPL120

# LED PENDANT MEASUREMENTS

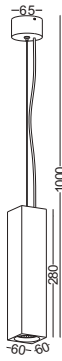

LPL185

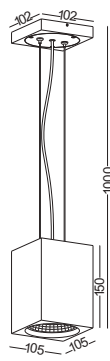

LPL186



LPL165

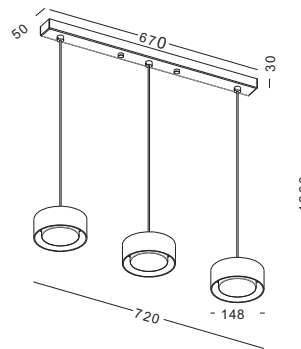

LPL166

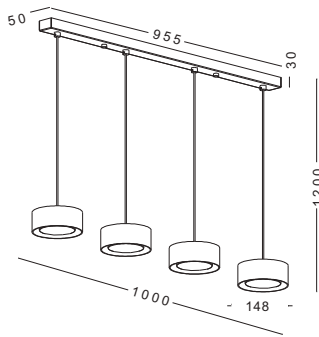

LPL167

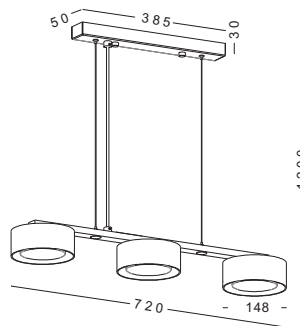

LPL168

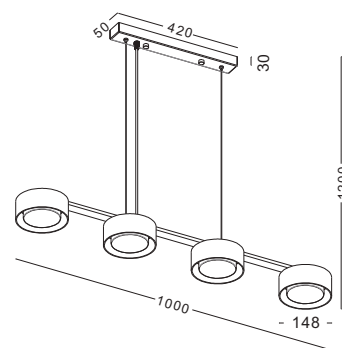

LPL169

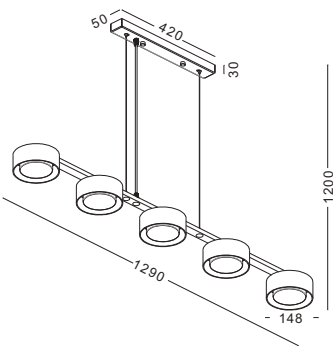

LPL170

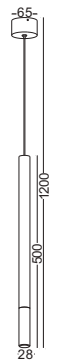

LPL187

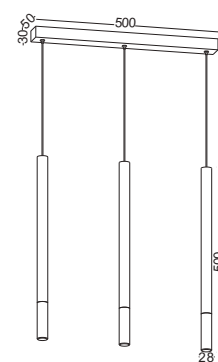

LPL188



LPL174



LPL176



LPL236



LPL237



LPL238

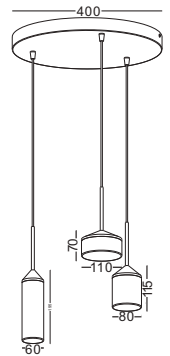

LPL239

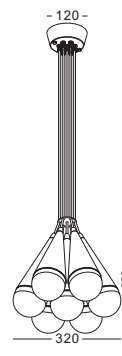

LPL273



# LED PENDANT MEASUREMENTS



LPL272



LPL271



LPL292



LPL293



LPL173

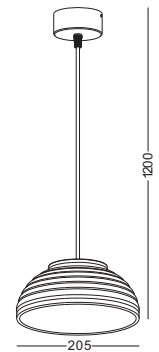

LPL217

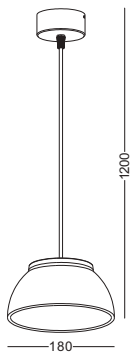

LPL215

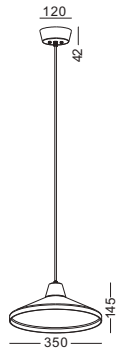

LPL281



LPL279

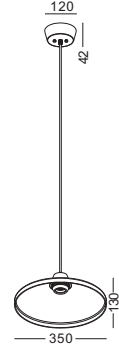

LPL282

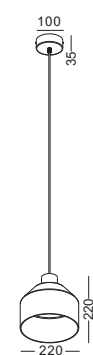

LPL280

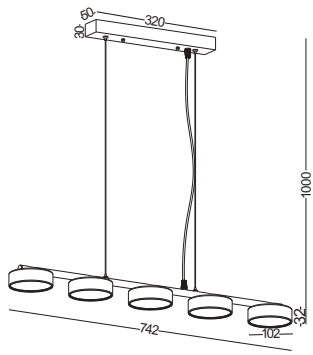

LPL194

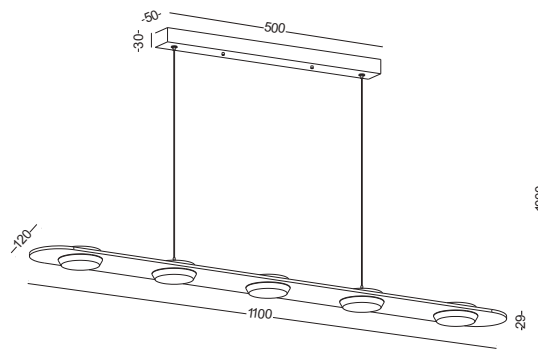

LPL205

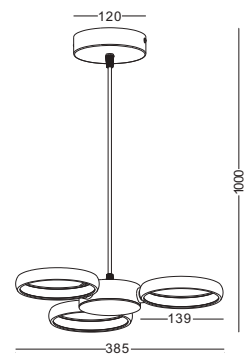

LPL196

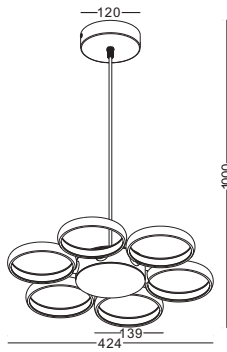

LPL197

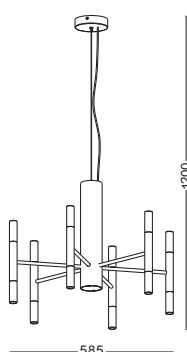

LPL212

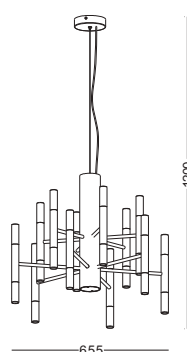

LPL213

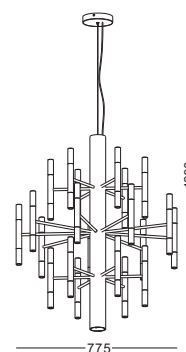

LPL214

# LED PENDANT MEASUREMENTS

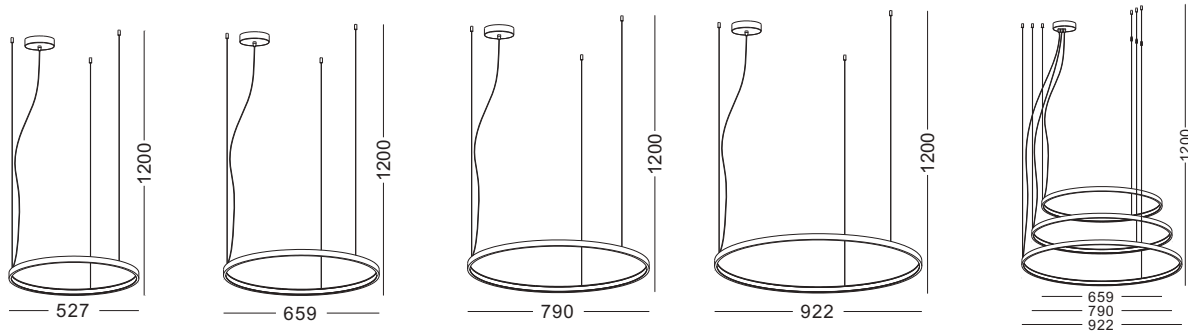

LPL252

LPL253

LPL254

LPL255

LPL256

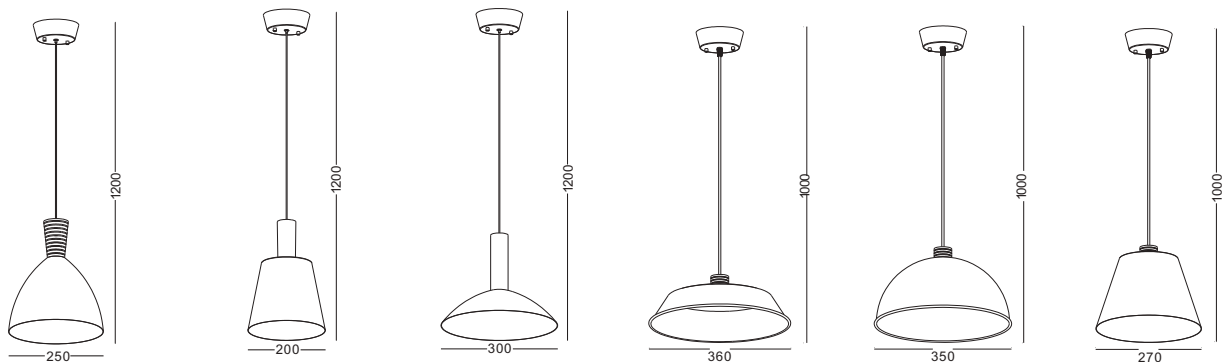

LPL221

LPL222

LPL223

LPL162

LPL163

LPL164

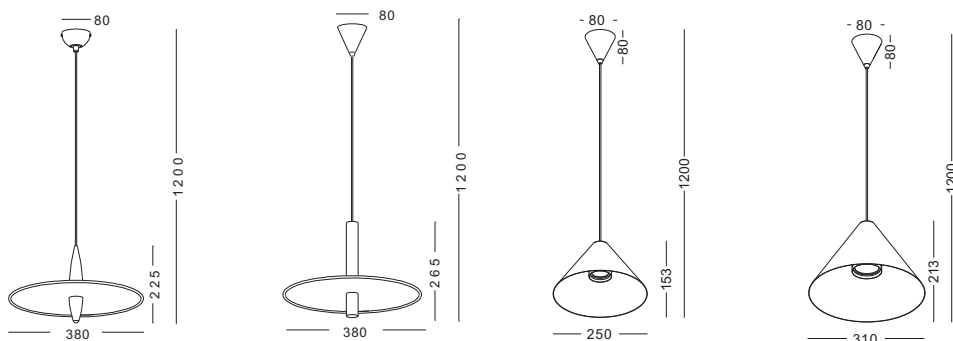

LPL171

LPL172

LPL227

LPL228

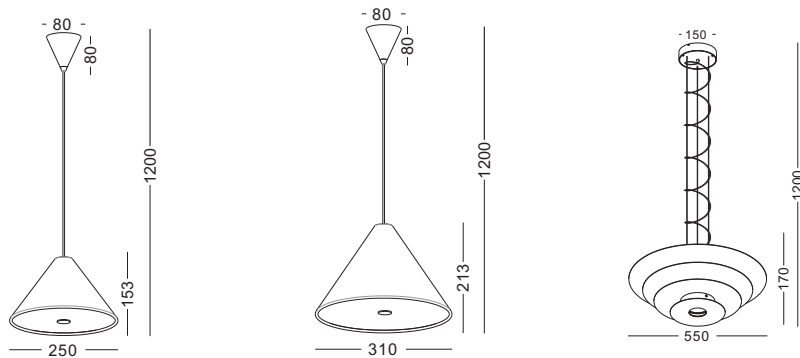

LPL298

LPL299

LPL312

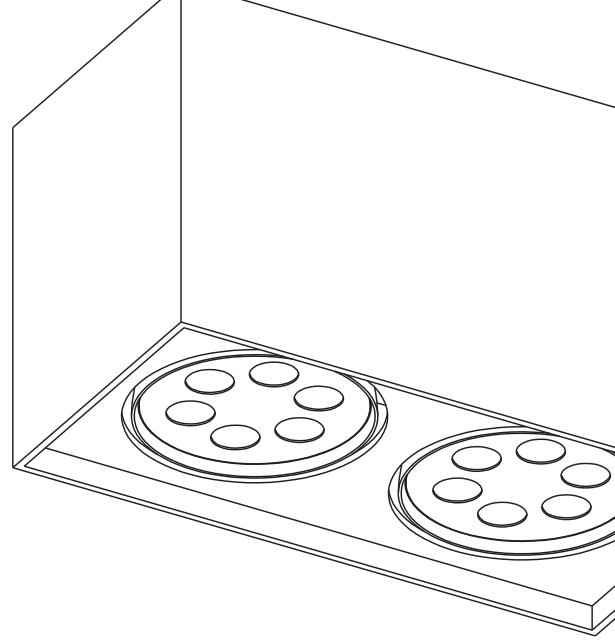
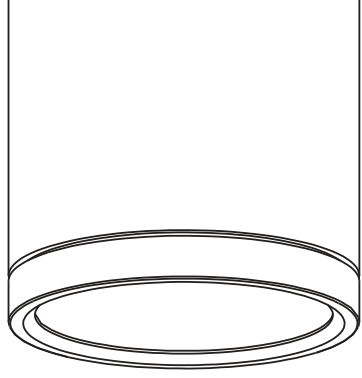

# LED CEILING LIGHT

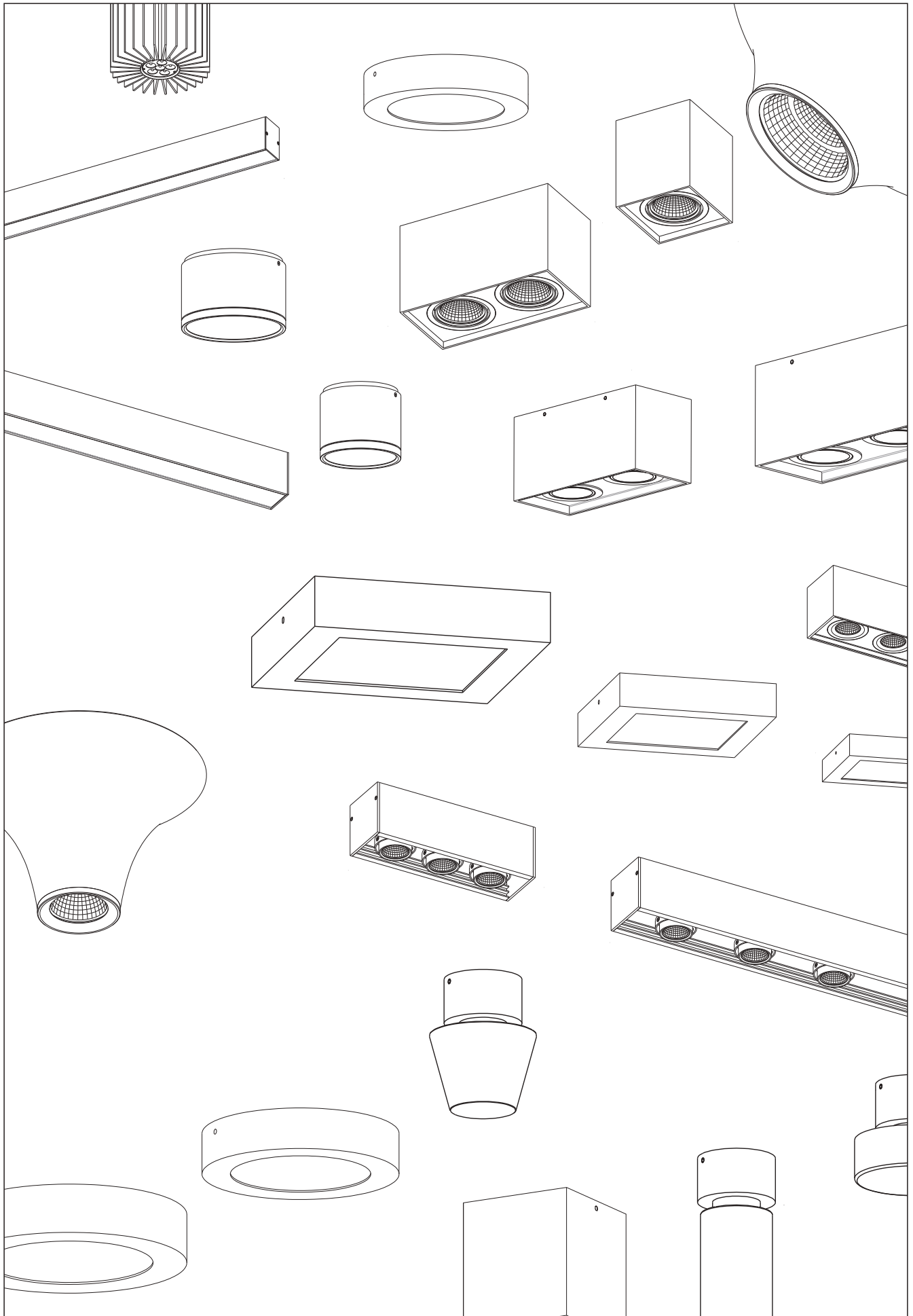







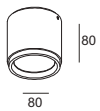

code **LBL104**

surface customizable  black paint equal to RAL9011  concrete grey paint similar to RAL7037  anodized gold sandblasted

casing aluminum / white painting / lamping SMD 4W / Ra>80 / 400LM / wide flood / 2700K/**3000K**/4000K/6000K

installation   **CE**  IP20

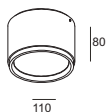

code **LBL105**

surface customizable  black paint equal to RAL9011  concrete grey paint similar to RAL7037  anodized gold sandblasted

casing aluminum / white painting / lamping SMD 10W / Ra>80 / 1000LM / wide flood / 2700K/**3000K**/4000K/6000K

installation   **CE**  IP20

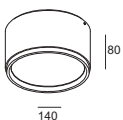

code **LBL106**

surface customizable  black paint equal to RAL9011  concrete grey paint similar to RAL7037  anodized gold sandblasted





casing aluminum / white painting / lamping SMD 20W / Ra>80 / 2000LM / wide flood / 2700K/**3000K**/4000K/6000K

installation   **CE**  IP20

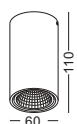













code **LBL118** surface customizable  black paint equal to RAL9011  white paint similar to RAL9003  concrete grey paint similar to RAL7037  anodized gold brushed circular





casing aluminum / anodized silver / lamping COB 5W / Ra>90 / 430LM / 15/24/38/60 degree / 2700K/3000K/4000K/6000K

installation     IP20 check photometric on page 001







code **LBL119** surface customizable  black paint equal to RAL9011  white paint similar to RAL9003  concrete grey paint similar to RAL7037  anodized gold brushed circular

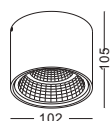



casing aluminum / anodized silver / lamping COB 9W / Ra>90 / 800LM / 15/24/38/60 degree / 2700K/3000K/4000K/6000K

installation     IP20 check photometric on page 001



code **LBL120** surface customizable  black paint equal to RAL9011  white paint similar to RAL9003  concrete grey paint similar to RAL7037  anodized gold brushed circular

casing aluminum / anodized silver / lamping COB 12W / Ra>90 / 900LM / 15/24/38/60 degree / 2700K/3000K/4000K/6000K

installation     IP20 check photometric on page 001

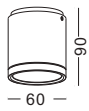

code **LBL135-BK**

surface customizable  concrete grey paint similar to RAL7037  anodized gold sandblasted

casing aluminum / black painting / lamping COB 5W / Ra>90 / 430LM / acrylic cover / 2700K/**3000K**/4000K/6000K

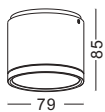

installation   **CE**  IP20 check photometric on page 001



code **LBL136-BK**

surface customizable  concrete grey paint similar to RAL7037  anodized gold sandblasted

casing aluminum / black painting / lamping COB 9W / Ra>90 / 800LM / acrylic cover / 2700K/**3000K**/4000K/6000K

installation   **CE**  IP20 check photometric on page 001

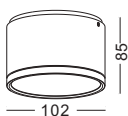

code **LBL137-BK**

surface customizable  concrete grey paint similar to RAL7037  anodized gold sandblasted

casing aluminum / black painting / lamping COB 12W / Ra>90 / 900LM / acrylic cover / 2700K/**3000K**/4000K/6000K

installation   **CE**  IP20 check photometric on page 001

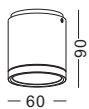

code **LBL135-WT**

surface customizable  concrete grey paint similar to RAL7037  anodized gold sandblasted

casing aluminum / white painting / lamping COB 5W / Ra>90 / 430LM / acrylic cover / 2700K/**3000K**/4000K/6000K

installation IP20 check photometric on page 001

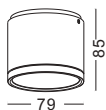

code **LBL136-WT**

surface customizable  concrete grey paint similar to RAL7037  anodized gold sandblasted

casing aluminum / white painting / lamping COB 9W / Ra>90 / 800LM / acrylic cover / 2700K/**3000K**/4000K/6000K

installation IP20 check photometric on page 001

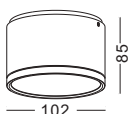

code **LBL137-WT**

surface customizable  concrete grey paint similar to RAL7037  anodized gold sandblasted

casing aluminum / white painting / lamping COB 12W / Ra>90 / 900LM / acrylic cover / 2700K/**3000K**/4000K/6000K

installation IP20 check photometric on page 001



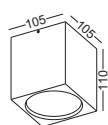

code **LBL172-BK**

surface customizable  white paint similar to RAL9003  concrete grey paint similar to RAL7037  anodized gold brushed

casing aluminum / anodized black / lamping SMD 10W / Ra>80 / 1000LM / acrylic cover / 2700K/**3000K**/4000K/6000K

installation     IP20 check photometric on page 001

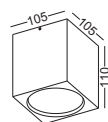

code **LBL172-SL**

surface customizable  white paint similar to RAL9003  concrete grey paint similar to RAL7037  anodized gold brushed

casing aluminum / anodized silver / lamping SMD 10W / Ra>80 / 1000LM / acrylic cover / 2700K/**3000K**/4000K/6000K

installation     IP20 check photometric on page 001



**GO RIGHT AHEAD**  
**THE WING FLOURISHING**







Microwave sensor customizable



Dimming customizable

**TRIAC**  
**DALI**  
0/1-10V



Type Approved  
Safety  
Regular Production  
Surveillance  
www.tuv.com  
ID 1419054303



code **LBL201-WT**

**TUV / SAA / cTUVus approved**

surface customizable

■ concrete grey paint similar to RAL7037

casing aluminum / white painting / lamping SMD 12W / Ra>80 / 1200LM / wide flood / 2700K/3000K/4000K/6000K

installation IP20 check photometric on page 001/ Customized to be Dimmable in TRIAC/DALI/0-10V

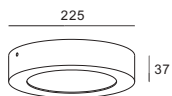

code **LBL202-WT**

surface customizable

■ concrete grey paint similar to RAL7037

casing aluminum / white painting / lamping SMD 18W / Ra>80 / 1800LM / wide flood / 2700K/3000K/4000K/6000K

installation IP20 check photometric on page 001/ Customized to be Dimmable in TRIAC/DALI/0-10V

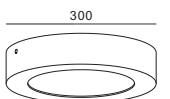

code **LBL203-WT**

surface customizable

■ concrete grey paint similar to RAL7037

casing aluminum / white painting / lamping SMD 24W / Ra>80 / 2400LM / wide flood / 2700K/3000K/4000K/6000K

installation IP20 check photometric on page 001/ Customized to be Dimmable in TRIAC/DALI/0-10V



Microwave sensor customizable



Dimming customizable

**TRIAC**  
**DALI**  
**0/1-10V**

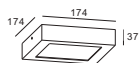

code **LBL203-WT**

surface customizable

■ concrete grey paint similar to RAL7037

casing aluminum / white painting / lamping SMD 12W / Ra>80 / 1200LM / wide flood / 2700K/~~3000K~~/4000K/6000K

installation IP20 check photometric on page 001/ Customized to be Dimmable in TRIAC/DALI/0-10V

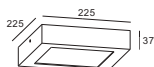

code **LBL204-WT**

surface customizable

■ concrete grey paint similar to RAL7037

casing aluminum / white painting / lamping SMD 18W / Ra>80 / 1800LM / wide flood / 2700K/~~3000K~~/4000K/6000K

installation IP20 check photometric on page 001/ Customized to be Dimmable in TRIAC/DALI/0-10V

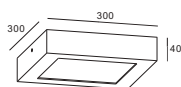

code **LBL205-WT**

surface customizable

■ concrete grey paint similar to RAL7037

casing aluminum / white painting / lamping SMD 24W / Ra>80 / 2400LM / wide flood / 2700K/~~3000K~~/4000K/6000K

installation IP20 check photometric on page 001/ Customized to be Dimmable in TRIAC/DALI/0-10V



Microwave sensor customizable



Dimming customizable

**TRIAC**  
**DALI**  
**0/1-10V**



Type Approved  
Safety  
Regular Production  
Surveillance  
www.tuv.com  
ID 1419054303

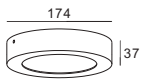

code **LBL201-BK**

**TUV / SAA / cTUVus approved**

surface customizable

■ concrete grey paint similar to RAL7037

casing aluminum / black painting / lamping SMD 12W / Ra>80 / 1200LM / wide flood / 2700K/~~3000K~~/4000K/6000K

installation IP20 check photometric on page 001/ Customized to be Dimmable in TRIAC/DALI/0-10V

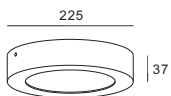

code **LBL202-BK**

surface customizable

■ concrete grey paint similar to RAL7037

casing aluminum / black painting / lamping SMD 18W / Ra>80 / 1800LM / wide flood / 2700K/~~3000K~~/4000K/6000K

installation IP20 check photometric on page 001/ Customized to be Dimmable in TRIAC/DALI/0-10V

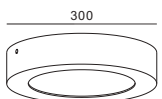

code **LBL203-BK**

surface customizable

■ concrete grey paint similar to RAL7037

casing aluminum / black painting / lamping SMD 24W / Ra>80 / 2400LM / wide flood / 2700K/~~3000K~~/4000K/6000K

installation IP20 check photometric on page 001/ Customized to be Dimmable in TRIAC/DALI/0-10V



Mircrowave sensor customizable



Dimming customizable

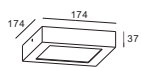

**TRIAC**  
**DALI**  
**0/1-10V**



code **LBL203-BK**

surface customizable  concrete grey paint similar to RAL7037

casing aluminum / black painting / lamping SMD 12W / Ra>80 / 1200LM / wide flood / 2700K/~~3000K~~/4000K/6000K

installation     IP20 check photometric on page 001/ Customized to be Dimmable in TRIAC/DALI/0-10V

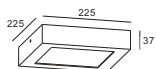

code **LBL204-BK**

surface customizable  concrete grey paint similar to RAL7037

casing aluminum / black painting / lamping SMD 18W / Ra>80 / 1800LM / wide flood / 2700K/~~3000K~~/4000K/6000K

installation     IP20 check photometric on page 001/ Customized to be Dimmable in TRIAC/DALI/0-10V

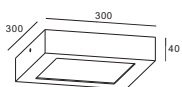

code **LBL205-BK**

surface customizable  concrete grey paint similar to RAL7037

casing aluminum / black painting / lamping SMD 24W / Ra>80 / 2400LM / wide flood / 2700K/~~3000K~~/4000K/6000K

installation     IP20 check photometric on page 001/ Customized to be Dimmable in TRIAC/DALI/0-10V





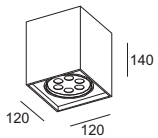

code **LBL074-WT / LBL074-BK**

surface customizable  concrete grey paint similar to RAL7037

casing aluminum / white/black painting / lamping LED 6x2W / Ra>80 / 1134 LM / 10/20/30/60 degree / 2700K/3000K/4000K/6000K

installation     IP20 check photometric on page 001

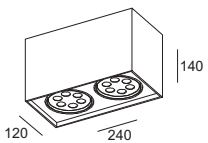

code **LBL075-WT / LBL075-BK**

surface customizable  concrete grey paint similar to RAL7037

casing aluminum / white/black painting / lamping LED 12x2W / Ra>80 / 2268 LM / 10/20/30/60 degree / 2700K/3000K/4000K/6000K

installation     IP20 check photometric on page 001







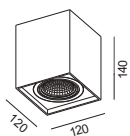

code **LBL176**

surface customizable  black paint equal to RAL9011  concrete grey paint similar to RAL7037

casing aluminum / white painting / lamping COB 12W / Ra>90 / 900LM / 15/24/38/60 degree / 2700K/3000K/4000K/6000K

installation     IP20 check photometric on page 001

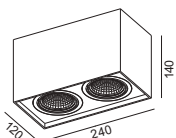

code **LBL177**

surface customizable  black paint equal to RAL9011  concrete grey paint similar to RAL7037

casing aluminum / white painting / lamping COB 24W / Ra>90 / 1800LM / 15/24/38/60 degree / 2700K/3000K/4000K/6000K

installation     IP20 check photometric on page 001





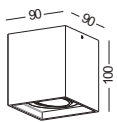

code **BLO01-WT**

casing aluminum / white painting / Gu10 socket / bulb not included

installation     IP20

surface customizable

 concrete grey paint similar to RAL7037

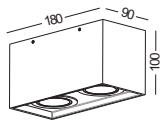

code **BLO02-WT**

casing aluminum / white painting / 2x Gu10 socket / bulb not included

installation     IP20

surface customizable

 concrete grey paint similar to RAL7037

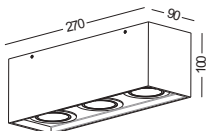

code **BLO03-WT**

casing aluminum / white painting / 3x Gu10 socket / bulb not included

installation     IP20

surface customizable

 concrete grey paint similar to RAL7037

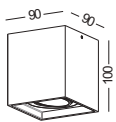

code **BLOO1-BK**

casing aluminum / black painting / Gu10 socket / bulb not included

installation     IP20

surface customizable

 concrete grey paint similar to RAL7037

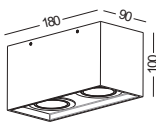

code **BLOO2-BK**

casing aluminum / black painting / 2x Gu10 socket / bulb not included

installation     IP20

surface customizable

 concrete grey paint similar to RAL7037

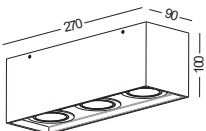

code **BLOO3-BK**

casing aluminum / black painting / 3x Gu10 socket / bulb not included





installation     IP20

surface customizable

 concrete grey paint similar to RAL7037







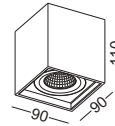

code **LWA173**  
casing aluminum / black painting  
lamping COB 5W / Ra>90 / 430LM  
Beam 15/24/38/60 degree  
2700K/3000K/4000K/6000K  
installation     IP20

surface customizable

 black paint equal to RAL9011  concrete grey paint similar to RAL7037



code **LWA174**  
casing aluminum / black painting  
lamping COB 2X5W / Ra>90 / 860LM  
Beam 15/24/38/60 degree  
2700K/3000K/4000K/6000K  
installation     IP20

surface customizable

 black paint equal to RAL9011  concrete grey paint similar to RAL7037

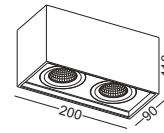

code **LWA175**  
casing aluminum / black painting  
lamping COB 3X5W / Ra>90 / 1290LM  
Beam 15/24/38/60 degree  
2700K/3000K/4000K/6000K  
installation     IP20

surface customizable

 black paint equal to RAL9011  concrete grey paint similar to RAL7037

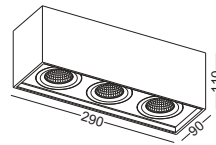





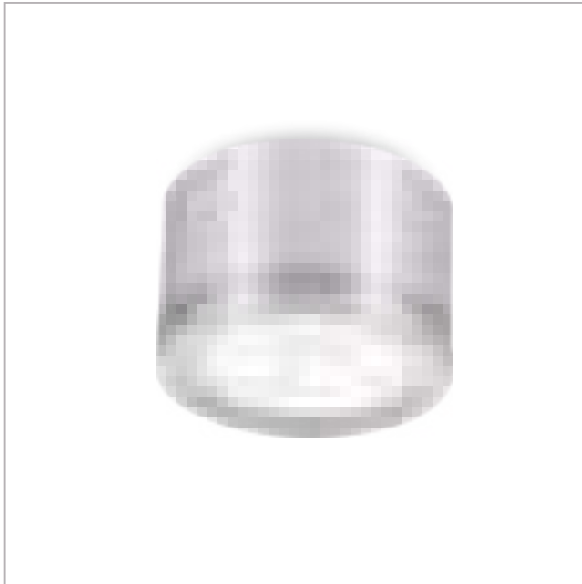

code **LBL602**  
 casing aluminum / anodized silver  
 lamping LED 6W / Ra>80 / 420LM  
 Beam 10/20/30/45/60 degree  
 2700K/3000K/4000K/6000K  
 installation IP20

surface customizable  

- black paint equal to RAL9011
- white paint similar to RAL9003
- concrete grey paint similar to RAL7037
- anodized silver sandblasted
- anodized gold brushed circular



code **LBL050**  
 casing aluminum / white paint  
 lamping COB 12W / Ra>90 / 900LM  
 Beam 15/24/38/60 degree  
 2700K/3000K/4000K/6000K  
 installation IP20

surface customizable  

- black paint equal to RAL9011
- concrete grey paint similar to RAL7037
- anodized silver sandblasted
- anodized gold brushed circular



code **LBL057**  
 casing aluminum / white paint  
 lamping LED 6W / Ra>80 / 420LM  
 Beam 10/20/30/45/60 degree  
 2700K/3000K/4000K/6000K  
 installation IP20

surface customizable  

- black paint equal to RAL9011
- concrete grey paint similar to RAL7037
- anodized silver sandblasted
- anodized gold brushed circular





LWA098



LWA096

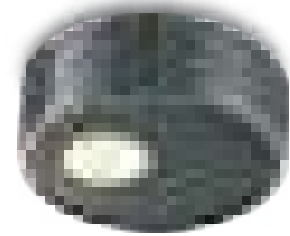

LWA095



LWA099

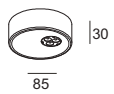

code **LBL095** surface customizable  white paint similar to RAL9003  concrete grey paint similar to RAL7037  anodized silver brushed circular  anodized gold brushed circular

casing aluminum / black plated / lamping LED 3W / Ra>80 / 210LM / 15/30/60 degree / 2700K/3000K/4000K/6000K

installation      IP20 check photometric on page 001

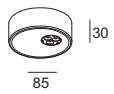

code **LBL096** surface customizable  white paint similar to RAL9003  concrete grey paint similar to RAL7037  anodized silver brushed circular  anodized gold brushed circular

casing aluminum / black plated / lamping LED 3W / Ra>80 / 210LM / 15/30/60 degree / 2700K/3000K/4000K/6000K

installation      IP20 check photometric on page 001

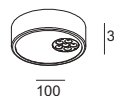

code **LBL098** surface customizable  white paint similar to RAL9003  concrete grey paint similar to RAL7037  anodized silver brushed circular  anodized gold brushed circular

casing aluminum / black plated / lamping LED 6W / Ra>80 / 420LM / 15/30/60 degree / 2700K/3000K/4000K/6000K

installation      IP20 check photometric on page 001

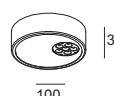



code **LBL099** surface customizable  white paint similar to RAL9003  concrete grey paint similar to RAL7037  anodized silver brushed circular  anodized gold brushed circular

casing aluminum / black plated / lamping LED 6W / Ra>80 / 420LM / 15/30/60 degree / 2700K/3000K/4000K/6000K

installation      IP20 check photometric on page 001







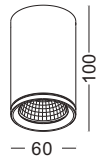





code **LBL049**  
 casing aluminum / white paint  
 lamping COB 5W / Ra>90 / 430LM  
 Beam 15/24/38/60 degree  
 2700K/3000K/4000K/6000K  
 installation     IP20



surface customizable





-  black paint equal to RAL9011
-  concrete grey paint similar to RAL7037
-  anodized silver sandblasted
-  anodized gold brushed circular

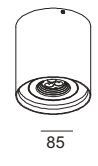

code **LBL054**  
 casing aluminum / white paint  
 lamping LED 3W / Ra>80 / 210LM  
 Beam 15/30/60 degree  
 2700K/3000K/4000K/6000K  
 installation     IP20



surface customizable

-  black paint equal to RAL9011
-  concrete grey paint similar to RAL7037
-  anodized silver sandblasted
-  anodized gold brushed circular



code **LBL110-BK**  
 casing aluminum / anodized black  
 lamping COB 5W / Ra>90 / 430LM  
 Beam 15/24/38/60 degree  
 2700K/3000K/4000K/6000K  
 installation

surface customizable

- black paint equal to RAL9011
- concrete grey paint similar to RAL7037
- anodized gold brushed linear



code **LBL110-WT**  
 casing aluminum / white paint  
 lamping COB 5W / Ra>90 / 430LM  
 Beam 15/24/38/60 degree  
 2700K/3000K/4000K/6000K  
 installation

surface customizable

- black paint equal to RAL9011
- concrete grey paint similar to RAL7037
- anodized gold brushed linear



code **LBL111-BK**  
 casing aluminum / anodized black  
 lamping COB 12W / Ra>90 / 900LM  
 Beam 15/24/38/60 degree  
 2700K/3000K/4000K/6000K  
 installation

surface customizable

- black paint equal to RAL9011
- concrete grey paint similar to RAL7037
- anodized gold brushed linear

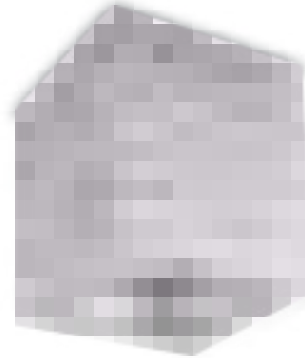

code **LBL111-SL**  
 casing aluminum / anodized silver  
 lamping COB 12W / Ra>90 / 900LM  
 Beam 15/24/38/60 degree  
 2700K/3000K/4000K/6000K  
 installation

surface customizable

- black paint equal to RAL9011
- concrete grey paint similar to RAL7037
- anodized gold brushed linear



code **LBL048-WT**

casing aluminum / white plated / lamping led 6W / Ra>80 / 420LM / 15/30/60 degree / 2700K/3000K/4000K/6000K

installation     IP20 check photometric on page 001



code **LBL048-BK**

casing aluminum / anodized black / lamping led 6W / Ra>80 / 420LM / 15/30/60 degree / 2700K/3000K/4000K/6000K

installation     IP20 check photometric on page 001



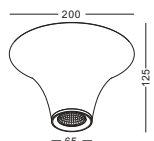

code **LBL052**

casing aluminum / white painting / lamping COB 5W / Ra>90 / 430LM / 15/24/38/60 degree / 2700K/3000K/4000K/6000K

installation IP20 check photometric on page 001

surface customizable black paint equal to RAL9011 concrete grey paint similar to RAL7037

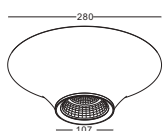

code **LBL053**

casing aluminum / white painting / lamping COB 9W / Ra>90 / 800LM / 15/24/38/60 degree / 2700K/3000K/4000K/6000K

installation IP20 check photometric on page 001

surface customizable black paint equal to RAL9011 concrete grey paint similar to RAL7037

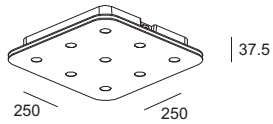

code **LBL083**

surface customizable  black paint equal to RAL9011  concrete grey paint similar to RAL7037

casing aluminum / white painting / lamping led 9x3W / Ra>80 / 1921LM / 15/30/45/60 degree / 2700K/3000K/4000K/6000K

installation     IP20 check photometric on page 001

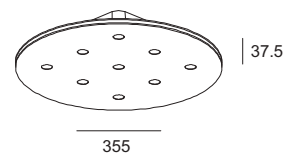

code **LBL084**

surface customizable  black paint equal to RAL9011  concrete grey paint similar to RAL7037





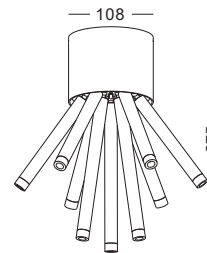

casing aluminum / white painting / lamping led 9x3W / Ra>80 / 1921LM / 15/30/45/60 degree / 2700K/3000K/4000K/6000K

installation     IP20 check photometric on page 001

LED DOWNLIGHT SURFACE MOUNT



*SURFACE MOUNTED  
STYLISH DOWNLIGHT  
ROTATABLE HEADS  
LENS INSIDE  
CAN BE USED  
AS A SPOTLIGHT*

code **LBL162-WT** surface customizable  concrete grey paint similar to RAL7037  anodized silver sandblasted  anodized gold sandblasted  
casing aluminum / white paint / lamping led 9x1W / Ra>80 / 630LM / 15/30/60 degree / 2700K/3000K/4000K/6000K  
installation     IP20 head 60 degree rotatable

code **LBL162-BK** surface customizable  concrete grey paint similar to RAL7037  anodized silver sandblasted  anodized gold sandblasted  
casing aluminum / anodized black / lamping led 9x1W / Ra>80 / 630LM / 15/30/60 degree / 2700K/3000K/4000K/6000K  
installation     IP20 head 60 degree rotatable

LED DOWNLIGHT SURFACE MOUNT

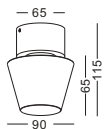

code **LBL207**

casing aluminum / white paint / lamping COB 5W / Ra>90 / 430LM / Acrylic diffuser / 2700K/3000K/4000K/6000K

installation IP20 check photometric on page 001

surface customizable concrete grey paint similar to RAL7037 anodized silver sandblasted anodized gold sandblasted

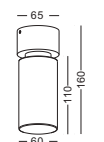

code **LBL208**

casing aluminum / white paint / lamping COB 5W / Ra>90 / 430LM / Acrylic diffuser / 2700K/3000K/4000K/6000K

installation IP20 check photometric on page 001

surface customizable concrete grey paint similar to RAL7037 anodized silver sandblasted anodized gold sandblasted

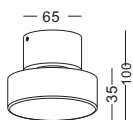

code **LBL209**

casing aluminum / white paint / lamping COB 5W / Ra>90 / 430LM / Acrylic diffuser / 2700K/3000K/4000K/6000K

installation IP20 check photometric on page 001

surface customizable concrete grey paint similar to RAL7037 anodized silver sandblasted anodized gold sandblasted





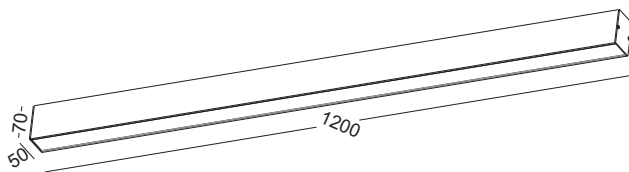

surface  
customizable

-  anodized silver  
brushed linear
-  concrete grey paint  
similar to RAL7037
-  anodized gold  
brushed linear

code **LBL 116-WT / LBL 116-BK / LBL 116-SL**

lamp length can be customized to 1800mm/2400mm.  
LED can be customized to 40W high lumen output

casing aluminum / white/black paint/anodized silver / lamping SMD 20W / Ra>80 / 1600LM / Acrylic cover / 2700K/**3000K**/4000K/6000K

installation     IP20 easy installation with spring clip, no screw installation / check photometric on page 001

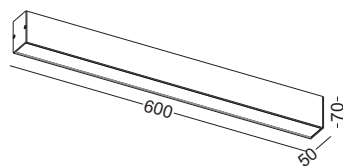

surface  
customizable

- concrete grey paint similar to RAL7037
- anodized gold brushed linear

code **LBL115-WT / LBL115-BK / LBL115-SL**

lamp length can be customized to 1800mm/2400mm,  
LED can be customized to 40W/1.2m high lumen output

casing aluminum / white/black paint/<sup>anodized</sup> silver / lamping SMD 20W / Ra>80 / 1600LM / Acrylic cover / 2700K/**3000K**/4000K/6000K

installation     IP20 easy installation with spring clip, no screw installation / check photometric on page 001



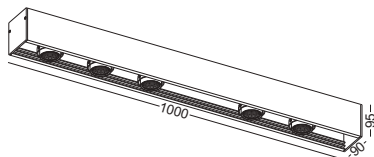

There is big difference between this series and other surface mounted spot lights, that is the lighting head could be moved freely along the aluminium extrusion. The light could be turned and moved, it helps to light objects in unfixed position. It shows like a surface mounted downlight but it functions like a track and several track lights.

surface customizable

-  black paint equal to RAL9011
-  white paint similar to RAL9003
-  concrete grey paint similar to RAL7037
-  anodized gold brushed linear

code **LBL108-5-SL**

lamp length can be customized to any size below 2400mm.  
Number of spots can be customized to any qty. if space permits

casing aluminum / anodized silver / lamping COB 5X5W / Ra>90 / 2150LM / 15/24/38/60 degree / 2700K/3000K/4000K/6000K

installation     IP20 easy installation, no screw seen on both sides

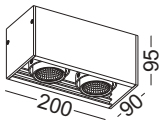

surface customizable

- black paint equal to RAL9011
- white paint similar to RAL9003
- concrete grey paint similar to RAL7037
- anodized gold brushed linear

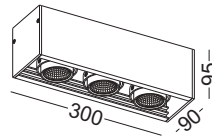

surface customizable

- black paint equal to RAL9011
- white paint similar to RAL9003
- concrete grey paint similar to RAL7037
- anodized gold brushed linear

code **LBL108-2-SL**

lamp length can be customized to any size below 2400mm.  
Number of spots can be customized to any qty. if space permits

casing aluminum / anodized silver / lamping COB 2X5W / Ra>90 / 860LM / 15/24/38/60 degree / 2700K/3000K/4000K/6000K

installation IP20 easy installation , no screw seen on both sides

code **LBL108-3-SL**

lamp length can be customized to any size below 2400mm.  
Number of spots can be customized to any qty. if space permits

casing aluminum / anodized silver / lamping COB 3X5W / Ra>90 / 1290LM / 15/24/38/60 degree / 2700K/3000K/4000K/6000K

installation IP20 easy installation , no screw seen on both sides



## BAYMAX SERIES SURFACE DOWNLIGHT

This series is consisted of pendants, surface downlights, spotlights. The idea is to make a ultimate surface downlight, with perfect shape and perfect light. The baymax series has realized all of this purpose, with square shape but nicely curved, and 23 degree beam, white painting. All above perfectly match the modern house decoration.

The name of BAYMAX comes from a Japanese cartoon film. BAYMAX is the major character of the film. He is warm hearted, but very strong and skilled. He is trained to protect people. Just like Baymax, this series of light have got nice white housing, and strong warm heart-high lumen output, with no harm to people--with anti-glare angle and checker glass front cover.

surface  
customizable

-  black paint  
equal to RAL9011
-  concrete grey paint  
similar to RAL7037
-  anodized silver  
sandblasted
-  anodized gold  
sandblasted



code **LBL210**

casing aluminum / white painting / lamping COB 5W / Ra>90 / 430LM / Beam 10/23/38 degree / 2700K/3000K/4000K/6000K

installation     IP20 check photometric on page 001



code **LBL211**

casing aluminum / white painting / lamping COB 5W / Ra>90 / 430LM / Beam 10/23/38 degree / 2700K/3000K/4000K/6000K

installation     IP20 check photometric on page 001

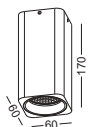

code **LBL212**

casing aluminum / white painting / lamping COB 5W / Ra>90 / 430LM / Beam 10/23/38 degree / 2700K/3000K/4000K/6000K

installation     IP20 check photometric on page 001



### BAYMAX SERIES SURFACE DOWNLIGHT BIGGER VERSION

This series is consisted of pendants, surface downlights, spotlights. The idea is to make a ultimate surface downlight, with perfect shape and perfect light. The baymax series has realized all of this purpose with square shape but nicely curved, and 23 degree beam, white painting. All above perfectly match the modern house decoration.

The name of BAYMAX comes from a Japanese cartoon film. BAYMAX is the major character of the film. He is warm hearted, but very strong and skilled. He is trained to protect people. Just like Baymax, this series of light have got nice white housing, and strong warm heart-high lumen output, with no harm to people--with anti-glare angle and checker glass front cover.

surface  
customizable

-  black paint  
equal to RAL9011
-  concrete grey paint  
similar to RAL7037
-  anodized silver  
sandblasted
-  anodized gold  
sandblasted

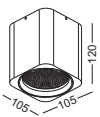

code **LBL213**

casing aluminum / white painting / lamping COB 12W / Ra>90 / 900LM / Beam 10/23/38 degree / 2700K/3000K/4000K/6000K

installation     IP20 check photometric on page 001

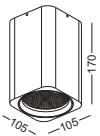

code **LBL214**

casing aluminum / white painting / lamping COB 12W / Ra>90 / 900LM / Beam 10/23/38 degree / 2700K/3000K/4000K/6000K

installation     IP20 check photometric on page 001

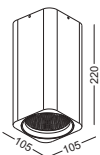

code **LBL215**

casing aluminum / white painting / lamping COB 12W / Ra>90 / 900LM / Beam 10/23/38 degree / 2700K/3000K/4000K/6000K

installation     IP20 check photometric on page 001



LAZER SERIES  
 SURFACE DOWNLIGHT  
 BLACK FRONT COVER  
 65 DEGREE ANT-GLARE ANGLE  
 23 DEGREE BEAM ANGLE  
 PERFECT LIGHT CIRCLE







surface customizable

-  black paint equal to RAL9011
-  concrete grey paint similar to RAL7037
-  chrome plated

code **LBL219-GD**  
 casing aluminum / anodized gold  
 lamping COB 5W / Ra>90 / 430LM  
 Beam 15/~~23~~/38 degree /  
 2700K/~~3000K~~/4000K/6000K  
 installation     IP20

code **LBL219-SL**  
 casing aluminum / anodized silver  
 lamping COB 5W / Ra>90 / 430LM  
 Beam 15/~~23~~/38 degree /  
 2700K/~~3000K~~/4000K/6000K  
 installation     IP20

code **LBL219-WT**  
 casing aluminum / white painting  
 lamping COB 5W / Ra>90 / 430LM  
 Beam 15/~~23~~/38 degree /  
 2700K/~~3000K~~/4000K/6000K  
 installation     IP20





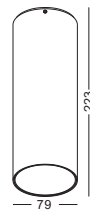

LAZER SERIES  
 SURFACE DOWNLIGHT  
 BLACK FRONT COVER  
 65 DEGREE ANT-GLARE ANGLE  
 23 DEGREE BEAM ANGLE  
 PERFECT LIGHT CIRCLE  
 9W MIDDLE SIZE







surface customizable

-  black paint equal to RAL9011
-  concrete grey paint similar to RAL7037
-  chrome plated

code **LBL220-GD**  
 casing aluminum / anodized gold  
 lamping COB 9W / Ra>90 / 800LM  
 Beam 15/23/38 degree /  
 2700K/3000K/4000K/6000K  
 installation     IP20

code **LBL220-SL**  
 casing aluminum / anodized silver  
 lamping COB 9W / Ra>90 / 800LM  
 Beam 15/23/38 degree /  
 2700K/3000K/4000K/6000K  
 installation     IP20

code **LBL220-WT**  
 casing aluminum / white painting  
 lamping COB 9W / Ra>90 / 800LM  
 Beam 15/23/38 degree /  
 2700K/3000K/4000K/6000K  
 installation     IP20





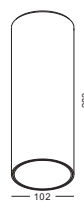

LAZER SERIES  
 SURFACE DOWNLIGHT  
 BLACK FRONT COVER  
 65 DEGREE ANT-GLARE ANGLE  
 23 DEGREE BEAM ANGLE  
 PERFECT LIGHT CIRCLE  
 12W LARGE SIZE







surface customizable

-  black paint equal to RAL9011
-  concrete grey paint similar to RAL7037
-  chrome plated

code **LBL221-GD**  
 casing aluminum / anodized gold  
 lamping COB 12W / Ra>90 /900LM  
 Beam 15/23/38 degree /  
 2700K/3000K/4000K/6000K  
 installation     IP20

code **LBL221-SL**  
 casing aluminum / anodized silver  
 lamping COB 12W / Ra>90 /900LM  
 Beam 15/23/38 degree /  
 2700K/3000K/4000K/6000K  
 installation     IP20

code **LBL221-WT**  
 casing aluminum / white painting  
 lamping COB 12W / Ra>90 /900LM  
 Beam 15/23/38 degree /  
 2700K/3000K/4000K/6000K  
 installation     IP20





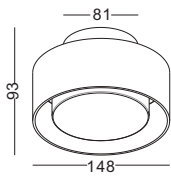

code **LBL229-BK**  
 casing aluminum / black painting  
 lamping LED 6W / Ra>80 /600LM  
 Beam acrylic diffuser /  
 2700K/~~3000K~~/4000K/6000K  
 installation IP20

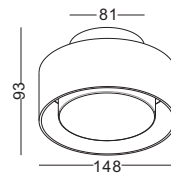

code **LBL229-WT**  
 casing aluminum / white painting  
 lamping LED 6W / Ra>80 /600LM  
 Beam acrylic diffuser /  
 2700K/~~3000K~~/4000K/6000K  
 installation IP20



code **LBL229-SL**  
 casing aluminum / anodized silver  
 lamping LED 6W / Ra>80 /600LM  
 Beam acrylic diffuser /  
 2700K/~~3000K~~/4000K/6000K  
 installation IP20



code **LBL229-GD**  
 casing aluminum / anodized silver  
 lamping LED 6W / Ra>80 /600LM  
 Beam acrylic diffuser /  
 2700K/~~3000K~~/4000K/6000K  
 installation IP20



code **LBL229-CR**  
 casing aluminum / chrome plated  
 lamping LED 6W / Ra>80 /600LM  
 Beam acrylic diffuser /  
 2700K/~~3000K~~/4000K/6000K  
 installation IP20



# LED CHANDELLIER

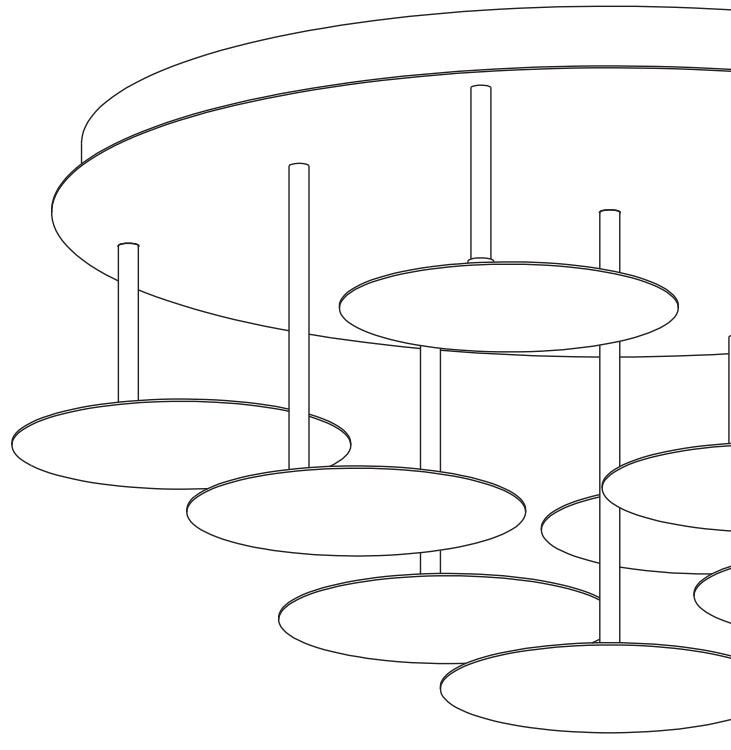







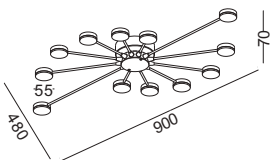

code **LBL169**

surface customizable  white paint similar to RAL9003  concrete grey paint similar to RAL7037

casing aluminum / anodized black / lamping LED 12x3W / Ra>80 / 1440LM / acrylic diffuser / 2700K/~~3000K~~ /4000K/6000K

installation     IP20 DALI / 0/1-10V / TRIAC dimming driver customizable

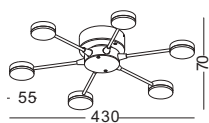

code **LBL167**

casing aluminum / anodized black /

installation     IP20

surface customizable

 white paint similar to RAL9003

 concrete grey paint similar to RAL7037

lamping LED 6x3W / Ra>80 / 720LM / acrylic diffuser / 2700K/**3000K** / 4000K/6000K

DALI / 0/1-10V / TRIAC dimming driver customizable

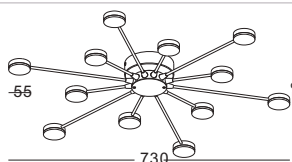

code **LBL168**

casing aluminum / anodized black /

installation     IP20

surface customizable

 white paint similar to RAL9003

 concrete grey paint similar to RAL7037

lamping LED 12x3W / Ra>80 / 1440LM / acrylic diffuser / 2700K/**3000K** / 4000K/6000K

DALI / 0/1-10V / TRIAC dimming driver customizable



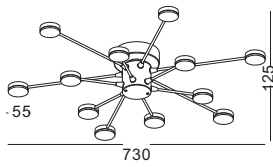

code **LBL 170**

casing aluminum / anodized black /

installation     IP20

surface customizable

 white paint similar to RAL9003

 concrete grey paint similar to RAL7037

lamping LED 12x3W / Ra>80 / 1440LM / acrylic diffuser / 2700K/3000K / 4000K/6000K

DALI / 0/1-10V / TRIAC dimming driver customizable

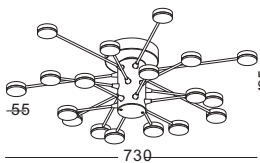

code **LBL 171**

casing aluminum / anodized black /

installation     IP20

surface customizable

 white paint similar to RAL9003

 concrete grey paint similar to RAL7037

lamping LED 18x3W / Ra>80 / 2160LM / acrylic diffuser / 2700K/3000K / 4000K/6000K

DALI / 0/1-10V / TRIAC dimming driver customizable

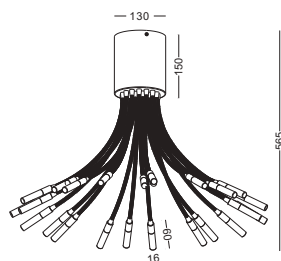

code **LBL143**

surface customizable  black paint equal to RAL9011  white paint similar to RAL9003  concrete grey paint similar to RAL7037

casing aluminum / chrome plated / lamping LED 24x1W / Ra>80 / 1680LM / acrylic diffuser / 2700K/**3000K**/4000K/6000K

installation IP20 DALI / 0/1-10V / TRIAC dimming driver customizable



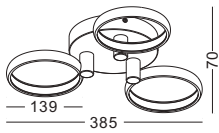

code **LBL 139**

surface customizable ■ black paint equal to RAL9011 ■ white paint similar to RAL9003 ■ concrete grey paint similar to RAL7037

casing aluminum / chrome plated / lamping LED 3x6W / Ra>80 / 1800LM / acrylic cover / 2700K/~~3000K~~/4000K/6000K

installation ■ ⚡ CE ▽ IP20 DALI / 0/1-10V / TRIAC dimming driver customizable

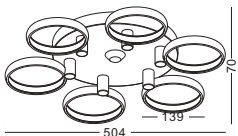

code **LBL 140**

surface customizable ■ black paint equal to RAL9011 ■ white paint similar to RAL9003 ■ concrete grey paint similar to RAL7037

casing aluminum / chrome plated / lamping LED 6x6W / Ra>80 / 3600LM / acrylic cover / 2700K/~~3000K~~/4000K/6000K

installation ■ ⚡ CE ▽ IP20 DALI / 0/1-10V / TRIAC dimming driver customizable



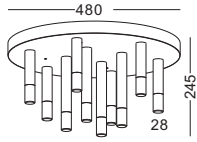

code **LBL158**

surface customizable  anodized gold sandblasted  white paint similar to RAL9003  concrete grey paint similar to RAL7037

casing aluminum / anodized black / lamping LED 10x3W / Ra>80 / 1200LM / acrylic diffuser / 2700K/3000K / 4000K/6000K

installation IP20 DALI / 0/1-10V / TRIAC dimming driver customizable

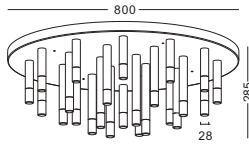

code **LBL159**

surface customizable  anodized gold sandblasted  white paint similar to RAL9003  concrete grey paint similar to RAL7037

casing aluminum / anodized black / lamping LED 24x3W / Ra>80 / 2880LM / acrylic diffuser / 2700K/3000K / 4000K/6000K

installation IP20 DALI / 0/1-10V / TRIAC dimming driver customizable



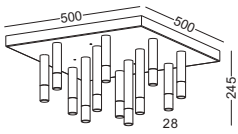

code **LBL160**

surface customizable  anodized gold sandblasted  white paint similar to RAL9003  concrete grey paint similar to RAL7037

casing aluminum / anodized black / lamping LED 12x3W / Ra>80 / 1440LM / acrylic diffuser / 2700K/~~3000K~~ /4000K/6000K

installation IP20 DALI / 0/1-10V / TRIAC dimming driver customizable

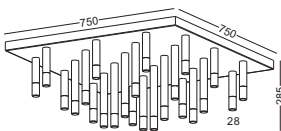

code **LBL161**

surface customizable  anodized gold sandblasted  white paint similar to RAL9003  concrete grey paint similar to RAL7037

casing aluminum / anodized black / lamping LED 24x3W / Ra>80 / 2880LM / acrylic diffuser / 2700K/~~3000K~~ /4000K/6000K

installation IP20 DALI / 0/1-10V / TRIAC dimming driver customizable

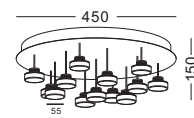

surface customizable

anodized gold sandblasted

anodized black sandblasted

white paint similar to RAL9003

code **LBL216**

casing aluminum heat sink/ chrome plated

lampping LED 13X3W / Ra>80 /1560LM

Beam acrylic diffuser /

2700K/3000K/4000K/6000K

installation     IP20

section switch / remote controller

DALI / 0/1-10V / TRIAC

dimming driver customizable

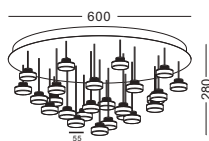

surface customizable

anodized gold sandblasted

anodized black sandblasted

white paint similar to RAL9003

code **LBL217**

casing aluminum heat sink/ chrome plated

lampping LED 25X3W / Ra>80 /3000LM

Beam acrylic diffuser /

2700K/3000K/4000K/6000K

installation     IP20

section switch / remote controller

DALI / 0/1-10V / TRIAC

dimming driver customizable

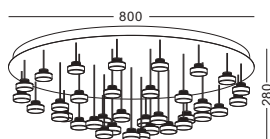

surface customizable

anodized gold sandblasted

anodized black sandblasted

white paint similar to RAL9003

code **LBL218**

casing aluminum heat sink/ chrome plated

lampping LED 35X3W / Ra>80 /4200LM

Beam acrylic diffuser /

2700K/3000K/4000K/6000K

installation     IP20

section switch / remote controller

DALI / 0/1-10V / TRIAC

dimming driver customizable



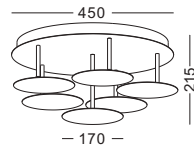

surface  
customizable

- anodized black  
sandblasted
- concrete grey paint  
similar to RAL7037

code **LBL165**

casing steel sheet / white paint

lampping LED 6X6W / Ra>80 /3600LM

Beam indirect light /

2700K/**3000K**/4000K/6000K

installation IP20

DALI / 0/1-10V / TRIAC  
dimming driver customizable

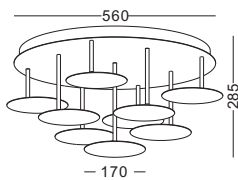

surface  
customizable

- anodized black  
sandblasted
- concrete grey paint  
similar to RAL7037

code **LBL166**

casing steel sheet / white paint

lampping LED 9X6W / Ra>80 /5400LM

Beam indirect light /





2700K/**3000K**/4000K/6000K

installation IP20

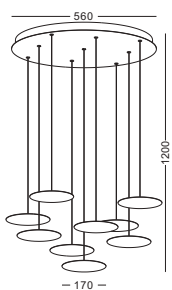
DALI / 0/1-10V / TRIAC  
dimming driver customizable









code **LPL241**  
 casing steel sheet / white paint  
 lamping LED 9X6W / Ra>80 / 5400LM  
 Beam indirect light /  
 2700K/3000K/4000K/6000K  
 installation     IP20

DALI / 0/1-10V / TRIAC  
 dimming driver customizable

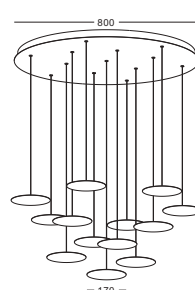
surface  
 customizable

-  anodized black sandblasted
-  concrete grey paint similar to RAL7037



code **LPL242**  
 casing steel sheet / white paint  
 lamping LED 13X6W / Ra>80 / 7800LM  
 Beam indirect light /  
 2700K/3000K/4000K/6000K  
 installation     IP20

DALI / 0/1-10V / TRIAC  
 dimming driver customizable

surface  
 customizable

-  anodized black sandblasted
-  concrete grey paint similar to RAL7037

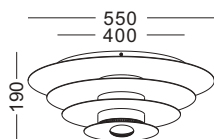

code **LBL231-WT**

casing aluminum / white paint / lamping SMD 18W+COB 9W / Ra>80 / 1800+800LM / 38 degree down/

2700K/~~3000K~~  
4000K/6000K

installation IP20

DALI / 0/1-10V / TRIAC dimming driver customizable

Related Products



Wall mount  
LWA318  
white paint

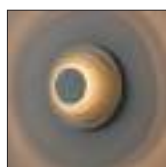

Wall mount  
LWA318  
grey paint



pendant  
LPL312  
white paint



pendant  
LPL312  
grey paint

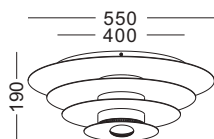

code **LBL231-GR**

casing aluminum / grey paint / lamping SMD 18W+COB 9W / Ra>80 / 1800+800LM / 38 degree down/

installation     IP20

DALI / 0/1-10V / TRIAC dimming driver customizable

2700K/~~3000K~~  
4000K/6000K

Related Products



Wall mount  
LWA318  
white paint



Wall mount  
LWA318  
grey paint



pendant  
LPL312  
white paint



pendant  
LPL312  
grey paint

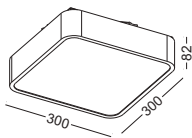

surface  
customizable

- black paint  
equal to RAL9011
- white paint  
similar to RAL9003
- concrete grey paint  
similar to RAL7037
- anodized gold  
brushed circular

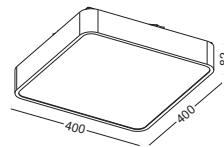

surface  
customizable

- black paint  
equal to RAL9011
- white paint  
similar to RAL9003
- concrete grey paint  
similar to RAL7037
- anodized gold  
brushed circular

code **LBL146**

casing aluminum / brushed silver / lamping LED 16W / Ra>80 / 1280LM / acrylic cover / 2700K/3000K/4000K/6000K

installation IP20 No dimming driver available / check photometric on page 001

code **LBL147**

casing aluminum / brushed silver / lamping LED 36W / Ra>80 / 2880LM / acrylic cover / 2700K/3000K/4000K/6000K

installation IP20 No dimming driver available / check photometric on page 001

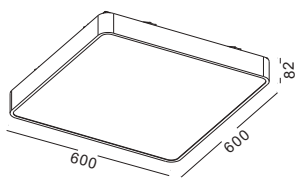

surface customizable

- black paint equal to RAL9011
- white paint similar to RAL9003
- concrete grey paint similar to RAL7037
- anodized gold brushed circular

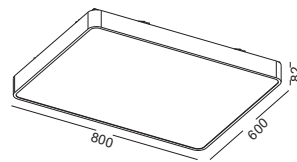

surface customizable

- black paint equal to RAL9011
- white paint similar to RAL9003
- concrete grey paint similar to RAL7037
- anodized gold brushed circular

code **LBL148**

casing aluminum / brushed silver / lamping LED 84W / Ra>80 / 6720LM / acrylic cover / 2700K/3000K/4000K/6000K

installation IP20 No dimming driver available / check photometric on page 001

code **LBL149**

casing aluminum / brushed silver / lamping LED 108W / Ra>80 / 8640LM / acrylic cover / 2700K/3000K/4000K/6000K

installation IP20 No dimming driver available / check photometric on page 001

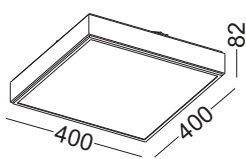

surface customizable

-  black paint equal to RAL9011
-  concrete grey paint similar to RAL7037
-  anodized silver brushed linear

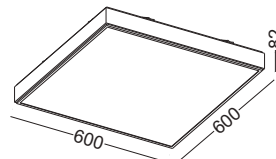

surface customizable

-  black paint equal to RAL9011
-  concrete grey paint similar to RAL7037
-  anodized silver brushed linear

code **LBL151**

casing aluminum / white paint / lamping LED 36W / Ra>80 /2880LM / acrylic cover / 2700K/~~3000K~~/4000K/6000K

installation     IP20 No dimming driver available / check photometric on page 001

code **LBL152**

casing aluminum / white paint / lamping LED 84W / Ra>80 /6720LM / acrylic cover / 2700K/~~3000K~~/4000K/6000K

installation     IP20 No dimming driver available / check photometric on page 001

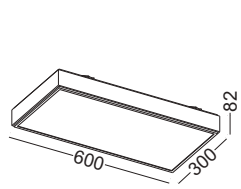

- surface customizable
- black paint equal to RAL9011
  - concrete grey paint similar to RAL7037
  - anodized silver brushed linear

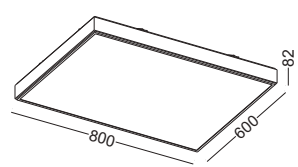

- surface customizable
- black paint equal to RAL9011
  - concrete grey paint similar to RAL7037
  - anodized silver brushed linear

code **LBL150**

casing aluminum / white paint / lamping LED 48W / Ra>80 /3840LM / acrylic cover / 2700K/~~3000K~~/4000K/6000K

installation IP20 No dimming driver available / check photometric on page 001

code **LBL153**

casing aluminum / white paint / lamping LED 108W / Ra>80 /8640LM / acrylic cover / 2700K/~~3000K~~/4000K/6000K

installation IP20 No dimming driver available / check photometric on page 001



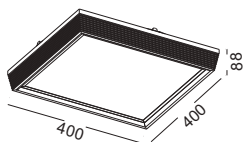

code **LBL155**

casing aluminum / anodized black and brushed / lamping LED 28W / Ra>80 / 2240LM / acrylic cover / 2700K/3000K/4000K/6000K

installation     IP20 No dimming driver available / check photometric on page 001

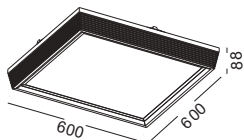

code **LBL156**

casing aluminum / anodized black and brushed / lamping LED 56W / Ra>80 / 4480LM / acrylic cover / 2700K/3000K/4000K/6000K

installation     IP20 No dimming driver available / check photometric on page 001

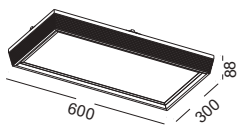

code **LBL154**

casing aluminum / anodized black and brushed / lamping LED 32W / Ra>80 / 2560LM / acrylic cover / 2700K/3000K/4000K/6000K

installation     IP20 No dimming driver available / check photometric on page 001

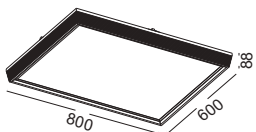

code **LBL157**

casing aluminum / anodized black and brushed / lamping LED 84W / Ra>80 / 6720LM / acrylic cover / 2700K/3000K/4000K/6000K

installation     IP20 No dimming driver available / check photometric on page 001

# LED TABLE LAMPS

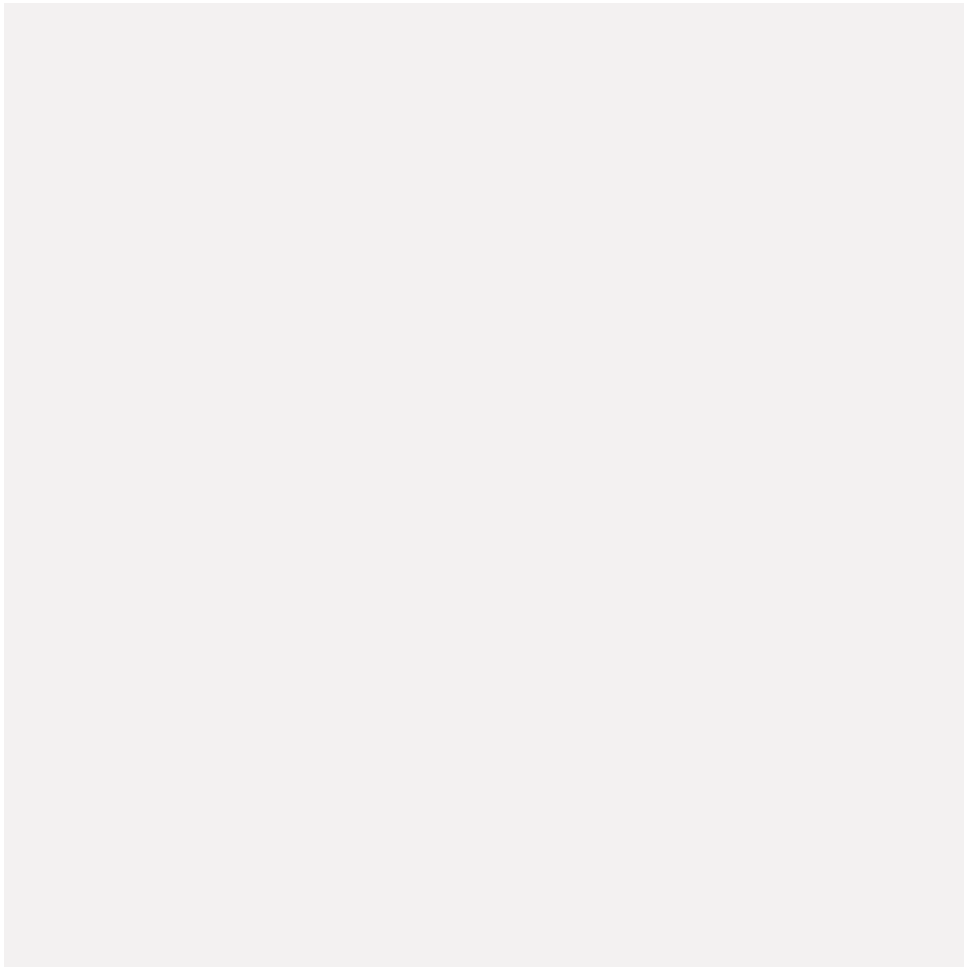

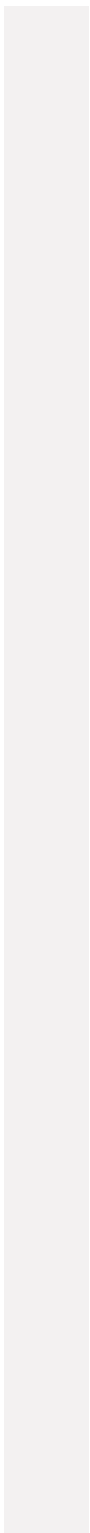

# LED FLOOR LAMPS

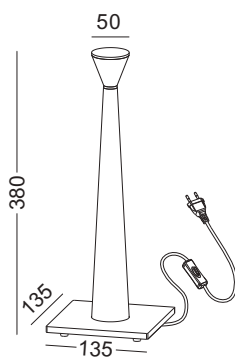



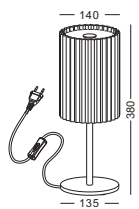

code **LTL027**  
 casing steel / chrome plated  
 lamping LED 3W / Ra>80 /300LM  
 Beam acrylic diffuser /  
 2700K/**3000K**/4000K/6000K  
 installation   **CE** IP20

surface  
 customizable  
 black paint  
 equal to RAL9011  
 white paint  
 similar to RAL9003



code **LTLO32-GD**  
 casing aluminum / anodized gold  
 lamping LED 2x6W / Ra>80 / 1200LM  
 Beam acrylic diffuser / up and down light  
 2700K/**3000K**/4000K/6000K  
 installation   **CE** IP20

code **LTLO32-SL**  
 casing aluminum / anodized silver

code **LTLO32-BK**  
 casing aluminum / anodized black



PENGUIN SERIES  
TABLE READING LAMP

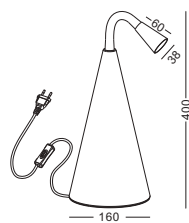

surface  
customizable

 chrome plated

 concrete grey paint  
similar to RAL7037

code **LTLO 18-BK**

casing steel / black painting

lamping LED 3W / Ra>80 / 120LM

Beam 10/20/**30** degree /  
2700K/**3000K**/4000K/6000K

installation   **CE** IP20

code **LTLO 18-WT**

casing steel / white painting

lamping LED 3W / Ra>80 / 120LM

Beam 10/20/**30** degree /  
2700K/**3000K**/4000K/6000K

installation   **CE** IP20

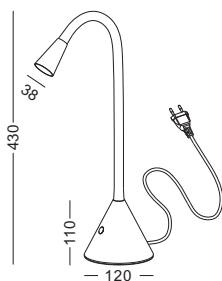

code **LTLO40**

casing aluminum / anodized black

lamping LED 3W / Ra>80 / 120LM

Beam 10/20/**30** degree /  
2700K/**3000K**/4000K/6000K

installation   **CE IP20**

With a touch-on switch on the base

surface  
customizable

 chrome plated

 white paint  
similar to RAL9003





code **LTL029-CR**

casing aluminum / chrome plated /

installation   **CE IP20**

surface customizable  white paint similar to RAL9003  concrete grey paint similar to RAL7037  anodized gold brushed circular

lamping COB 3W / Ra>90 / 300LM / acrylic diffuser / 2700K/~~3000K~~/4000K/6000K

EU standard plug with switch on the cable / 1.5M cable

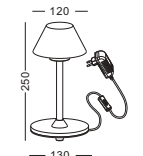

code **LTL030-CR**

casing aluminum / chrome plated /

installation   **CE IP20**

surface customizable  white paint similar to RAL9003  concrete grey paint similar to RAL7037  anodized gold brushed circular

lamping COB 3W / Ra>90 / 300LM / acrylic diffuser / 2700K/~~3000K~~/4000K/6000K

EU standard plug with switch on the cable / 1.5M cable



code **LTL031-CR**

casing aluminum / chrome plated /

installation   **CE IP20**

surface customizable  white paint similar to RAL9003  concrete grey paint similar to RAL7037  anodized gold brushed circular

lamping COB 3W / Ra>90 / 300LM / acrylic diffuser / 2700K/~~3000K~~/4000K/6000K

EU standard plug with switch on the cable / 1.5M cable



code **LTL029-BK**

surface customizable  white paint similar to RAL9003  concrete grey paint similar to RAL7037  anodized gold brushed circular

casing aluminum / anodized black / lamping COB 3W / Ra>90 / 300LM / acrylic diffuser / 2700K/**3000K**/4000K/6000K

installation   **IP20** EU standard plug with switch on the cable / 1.5M cable



code **LTL030-BK**

surface customizable  white paint similar to RAL9003  concrete grey paint similar to RAL7037  anodized gold brushed circular

casing aluminum / anodized black / lamping COB 3W / Ra>90 / 300LM / acrylic diffuser / 2700K/**3000K**/4000K/6000K

installation   **IP20** EU standard plug with switch on the cable / 1.5M cable



code **LTL031-BK**

surface customizable  white paint similar to RAL9003  concrete grey paint similar to RAL7037  anodized gold brushed circular

casing aluminum / anodized black / lamping COB 3W / Ra>90 / 300LM / acrylic diffuser / 2700K/**3000K**/4000K/6000K

installation   **IP20** EU standard plug with switch on the cable / 1.5M cable



LTL023

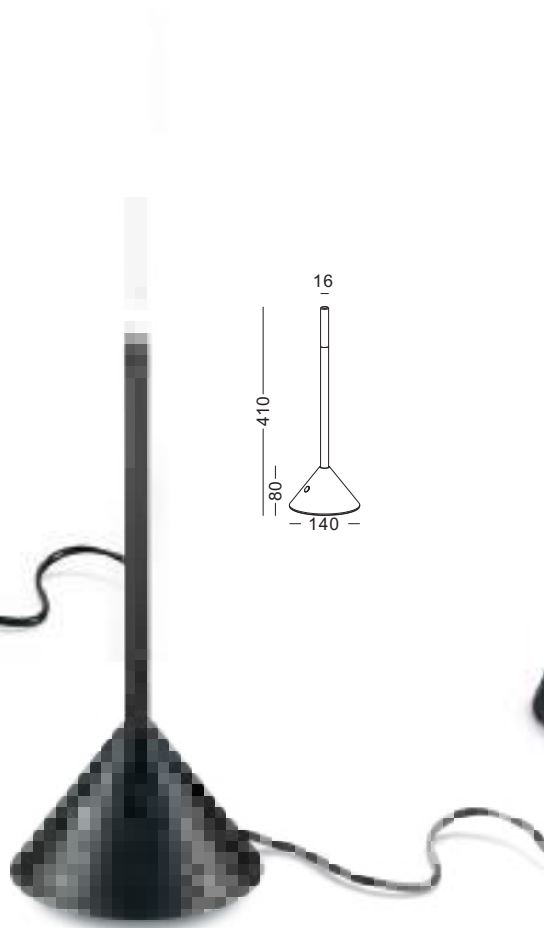
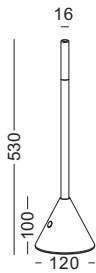

LTL022

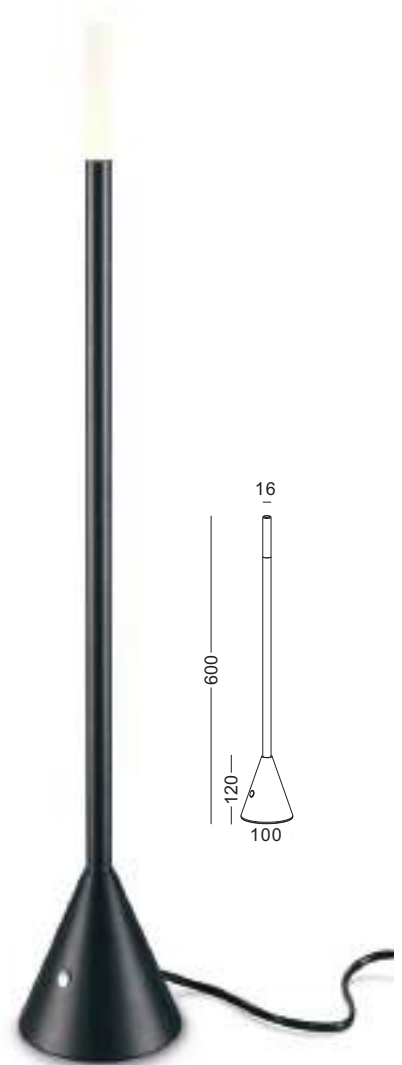
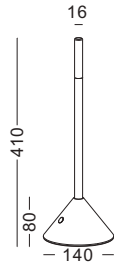

LTL024

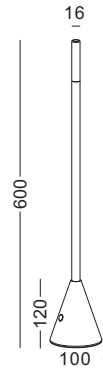

code **LTL022**

surface customizable

white paint similar to RAL9003

concrete grey paint similar to RAL7037

anodized gold brushed circular

casing aluminum / anodized black /

lamping LED 1W / Ra>80 / 70LM / acrylic diffuser /

2700K/3000K/4000K/6000K/RED/GREEN/BLUE

installation IP20

EU standard plug with switch on the cable / 1.5M cable

code **LTL023**

surface customizable

white paint similar to RAL9003

concrete grey paint similar to RAL7037

anodized gold brushed circular

casing aluminum / anodized black /

lamping LED 1W / Ra>80 / 70LM / acrylic diffuser /

2700K/3000K/4000K/6000K/RED/GREEN/BLUE

installation IP20

EU standard plug with switch on the cable / 1.5M cable

code **LTL024**

surface customizable

white paint similar to RAL9003

concrete grey paint similar to RAL7037

anodized gold brushed circular

casing aluminum / anodized black /

lamping LED 1W / Ra>80 / 70LM / acrylic diffuser /

2700K/3000K/4000K/6000K/RED/GREEN/BLUE

installation IP20

EU standard plug with switch on the cable / 1.5M cable

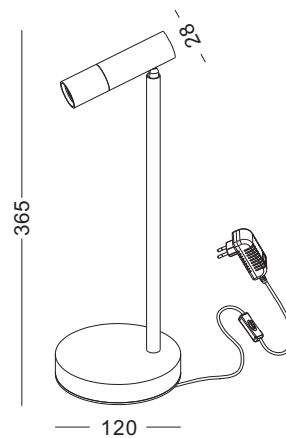

code **LTL038-CR / LTL038-WT / LTL038-BK**

casing aluminum+beech / chrome plated / white paint / anodized black

installation **IP20**

surface customizable

concrete grey paint similar to RAL7037

anodized gold brushed circular

/ lamping LED 3W / Ra>80 / 120LM / 30 degree / 2700K/~~3000K~~/4000K/6000K

EU standard plug with switch on the cable/ driver in the plug box / 1.5M cable



code **LFL019-BK**

surface customizable  concrete grey paint similar to RAL7037

anodized gold brushed circular

casing aluminum / black painting / lamping LED 1W / Ra>80 / 70LM / acrylic diffuser / 2700K/~~3000K~~/4000K/6000K/RED/GREEN/BLUE

installation   **CE** IP20

EU standard plug with switch on the cable / 1.5M cable



code **LFL019-WT**

surface customizable  concrete grey paint similar to RAL7037

anodized gold brushed circular

casing aluminum / white painting / lamping LED 1W / Ra>80 / 70LM / acrylic diffuser / 2700K/~~3000K~~/4000K/6000K/RED/GREEN/BLUE

installation   **CE** IP20

EU standard plug with switch on the cable / 1.5M cable

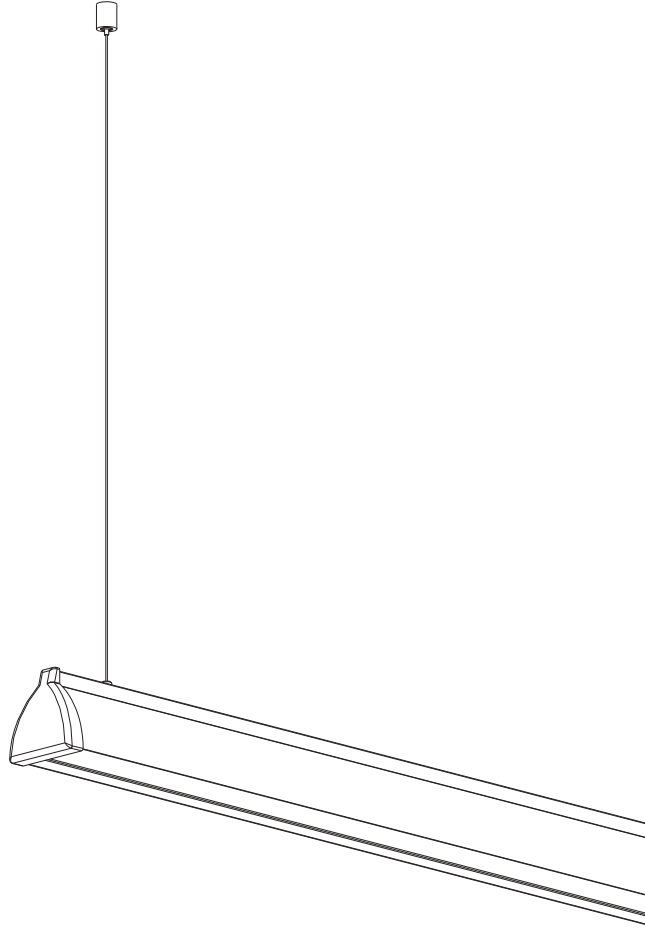
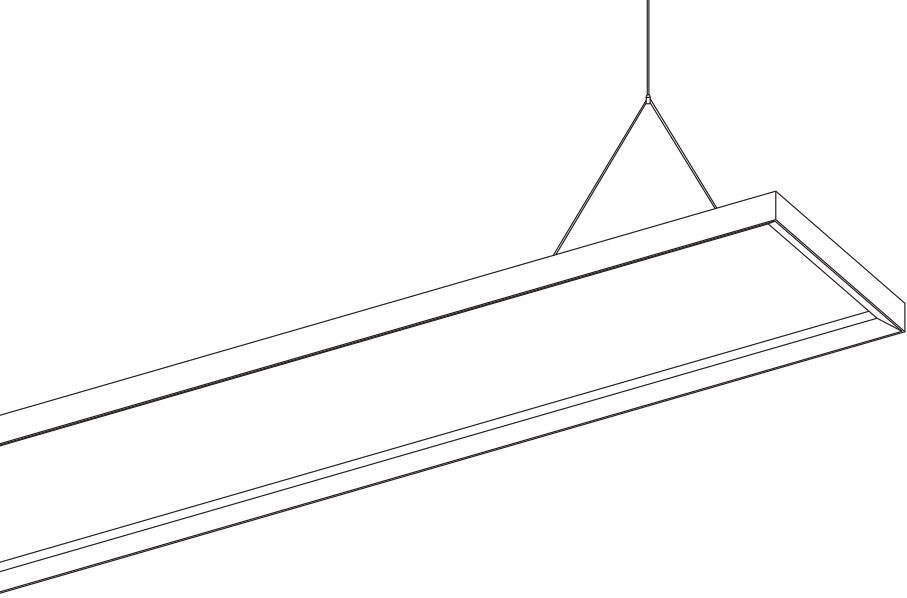

LED  
OFFICE  
PENDANT  
LIGHT





# OFFICE PENDANT LIGHT

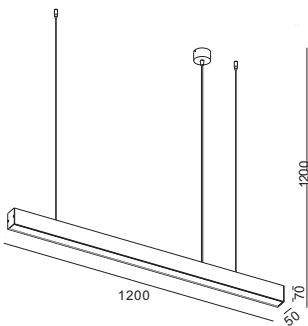

- made by pure aluminum extrusion can be custom made into any length normal size will be 600mm/1200mm /1800mm/2400mm
- five surface color available three surface colors in stock
- 20W led per 1.2 meter long 10W led for 0.6 meter and so on
- Can be made to be more power double to 40W or other for the same length
- supplied with 1.2m hanging cable, electric wire, and connecting box

IP20

code	casing	finishing	lamping	CRI	lumen	diffuser	LED color
LPL159-WT	aluminum	white paint	SMD 20W	Ra>80	1600lm	Acrylic	2700K/3000K /4000K/6000K
LPL159-SL	aluminum	brushed silver	SMD 20W	Ra>80	1600lm	Acrylic	2700K/3000K /4000K/6000K
LPL159-BK	aluminum	black paint	SMD 20W	Ra>80	1600lm	Acrylic	2700K/3000K /4000K/6000K

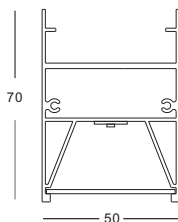

- surface default
- white paint similar to RAL9003
  - black paint equal to RAL9011
  - anodized silver brushed linear

- surface customizable
- concrete grey paint similar to RAL7037
  - anodized gold sandblasted



although this series is boring, simple, just as the same as series came from any other supplies. The same aluminium extrusion, the same style, the same thin lamp body and same looking however, LED make it another lamp. 20W SMD led gives as much as the 1600lumens output, which is the same as a 32W fluorescent tube gives, while the consumption is half.

LED is not the ultimate terminal for energy-saving. The point is how people are thinking. Passun devotes its designing philosophy in every aspect. We insist on not only saving on the lamp source, but also in material consumption. We always make sure that the material to make the lamp is just sufficient, no more to waste, and no less.

This lamp is designed to fulfill the basic lighting requirement for the office, 1600lm is just enough for a 1.4m desk and no more is needed. Three lamp colors could be customer made according to different office style.

# OFFICE PENDANT LIGHT









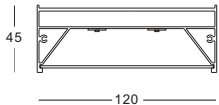

 IP20

code	casing	finishing	lamping	CRI	lumen	diffuser	LED color
LPL160-WT	aluminum	white paint	SMD 40W	Ra>80	3200lm	Acrylic	2700K/3000K /4000K/6000K
LPL160-SL	aluminum	brushed silver	SMD 40W	Ra>80	3200lm	Acrylic	2700K/3000K /4000K/6000K
LPL160-BK	aluminum	black paint	SMD 40W	Ra>80	3200lm	Acrylic	2700K/3000K /4000K/6000K



### surface default

-  white paint similar to RAL9003
-  black paint equal to RAL9011
-  anodized silver brushed linear

### surface customizable

-  concrete grey paint similar to RAL7037
-  anodized gold sandblasted

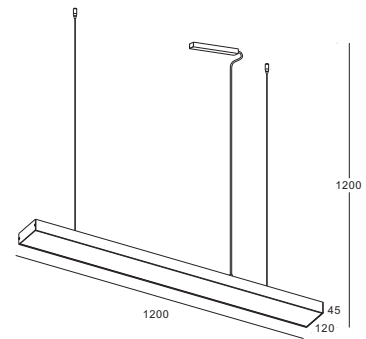

- made by pure aluminum extrusion can be custom made into any length normal size will be 600mm/1200mm/1800mm/2400mm
- five surface color available three surface colors in stock
- 40W led per 1.2 meter long 20W led for 0.6 meter and so on
- Can be made to be more power double to 80W or other for the same length
- supplied with 1.2m hanging cable, electric wire, and connecting box

# OFFICE PENDANT LIGHT

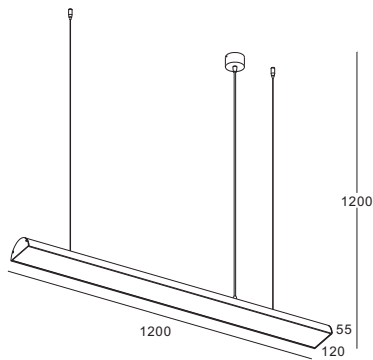
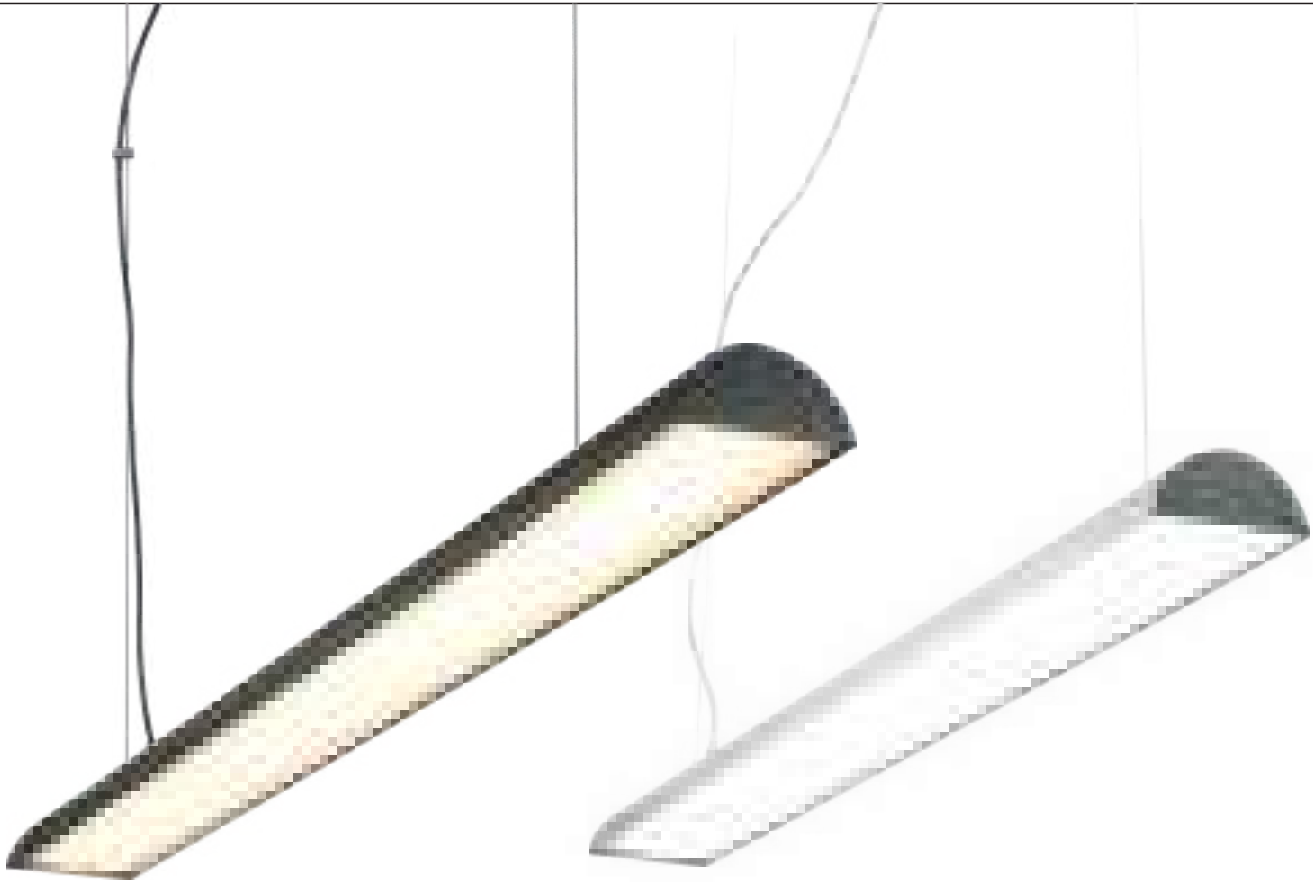

- made by pure aluminum extrusion can be custom made into any length normal size will be 600mm/1200mm/1800mm/2400mm
- five surface color available three surface colors in stock
- 40W led per 1.2 meter long 20W led for 0.6 meter and so on
- Can be made to be more power double to 80W or other for the same length
- supplied with 1.2m hanging cable, electric wire, and connecting box

IP20

code	casing	finishing	lamping	CRI	lumen	diffuser	LED color
LPL161-WT	aluminum	white paint	SMD 40W	Ra>80	3200lm	Acrylic	2700K/3000K/4000K/6000K
LPL161-SL	aluminum	brushed silver	SMD 40W	Ra>80	3200lm	Acrylic	2700K/3000K/4000K/6000K
LPL161-BK	aluminum	black paint	SMD 40W	Ra>80	3200lm	Acrylic	2700K/3000K/4000K/6000K

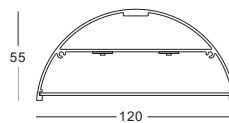

surface default



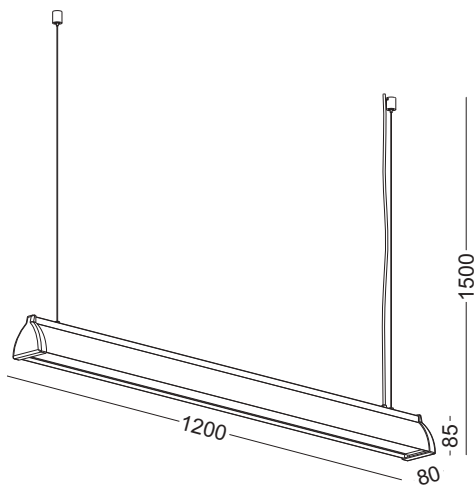

- white paint similar to RAL9003
- black paint equal to RAL9011
- anodized silver brushed linear

surface customizable

- concrete grey paint similar to RAL7037
- anodized gold sandblasted



surface default

-  white paint similar to RAL9003
-  anodized black sandblasted
-  anodized silver sandblasted
-  anodized gold sandblasted

surface customizable

-  concrete grey paint similar to RAL7037

- made by pure aluminum extrusion can be custom made into any length normal size will be 600mm/1200mm/1800mm/2400mm
- five surface color available four surface colors in stock
- 40W led per 1.5 meter long 20W led for 0.6 meter and so on
- Can be made to be more power double to 80W or other for the same length
- supplied with 1.2m hanging cable, electric wire, and connecting box

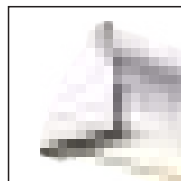
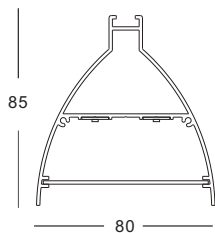

Chrome plated end cap makes the lamp noble and good quality

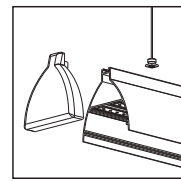

The hanging cable metal parts can move freely along the extrusion. It helps a lot in installation.

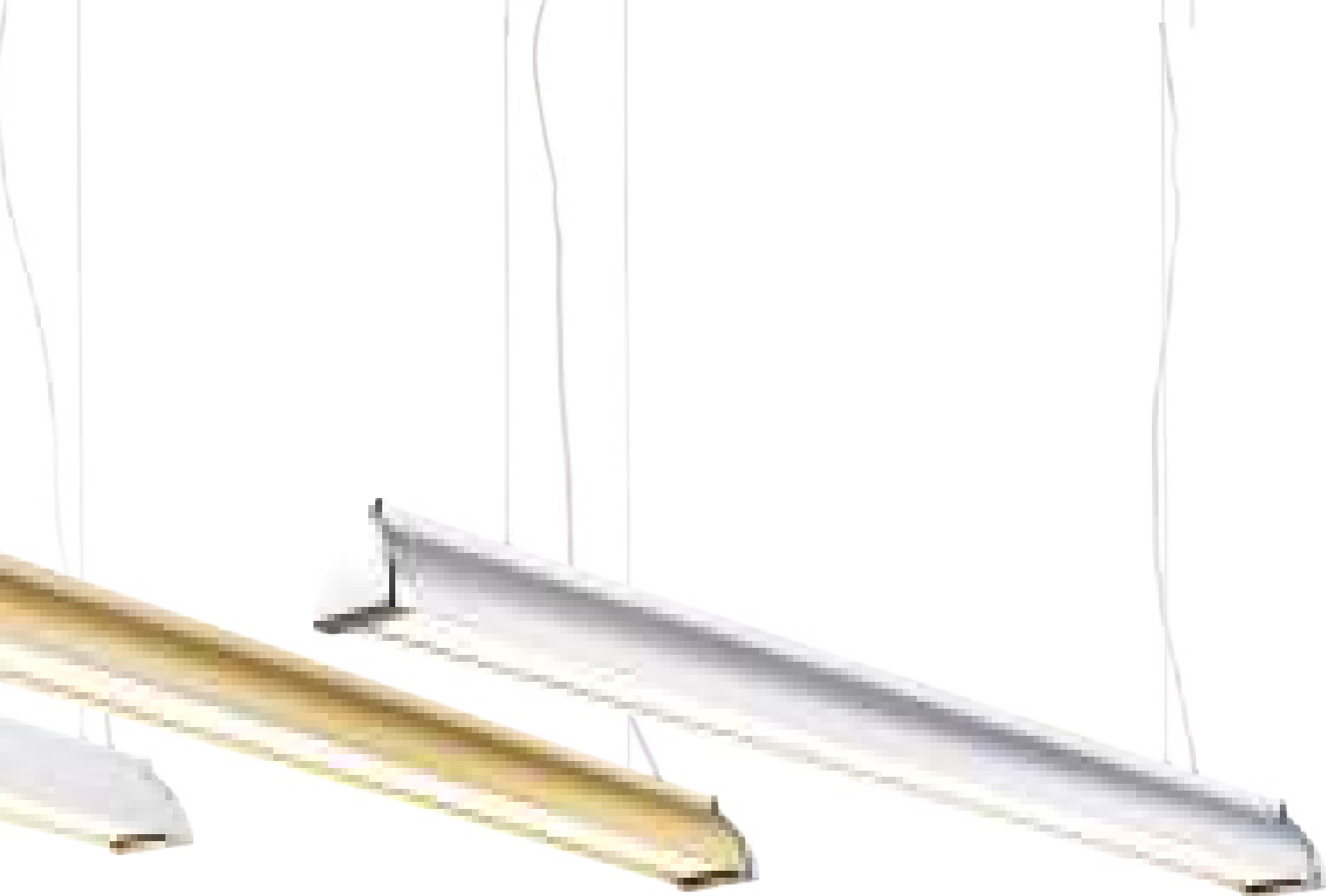





 IP20

	code	casing	finishing	lamping	CRI	lumen	diffuser	LED color
	LPL291-BK	aluminum	anodized black	SMD 40W	Ra>80	3200lm	Acrylic	2700K/3000K/4000K/6000K
	LPL291-WT	aluminum	white paint	SMD 40W	Ra>80	3200lm	Acrylic	2700K/3000K/4000K/6000K
	LPL291-WT	aluminum	anodized gold	SMD 40W	Ra>80	3200lm	Acrylic	2700K/3000K/4000K/6000K
	LPL291-WT	aluminum	anodized silver	SMD 40W	Ra>80	3200lm	Acrylic	2700K/3000K/4000K/6000K

# OFFICE PENDANT LIGHT

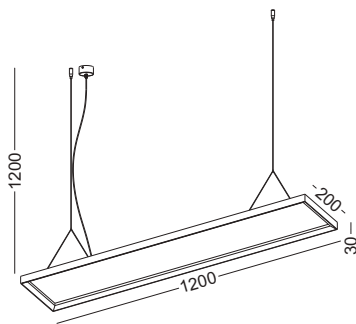
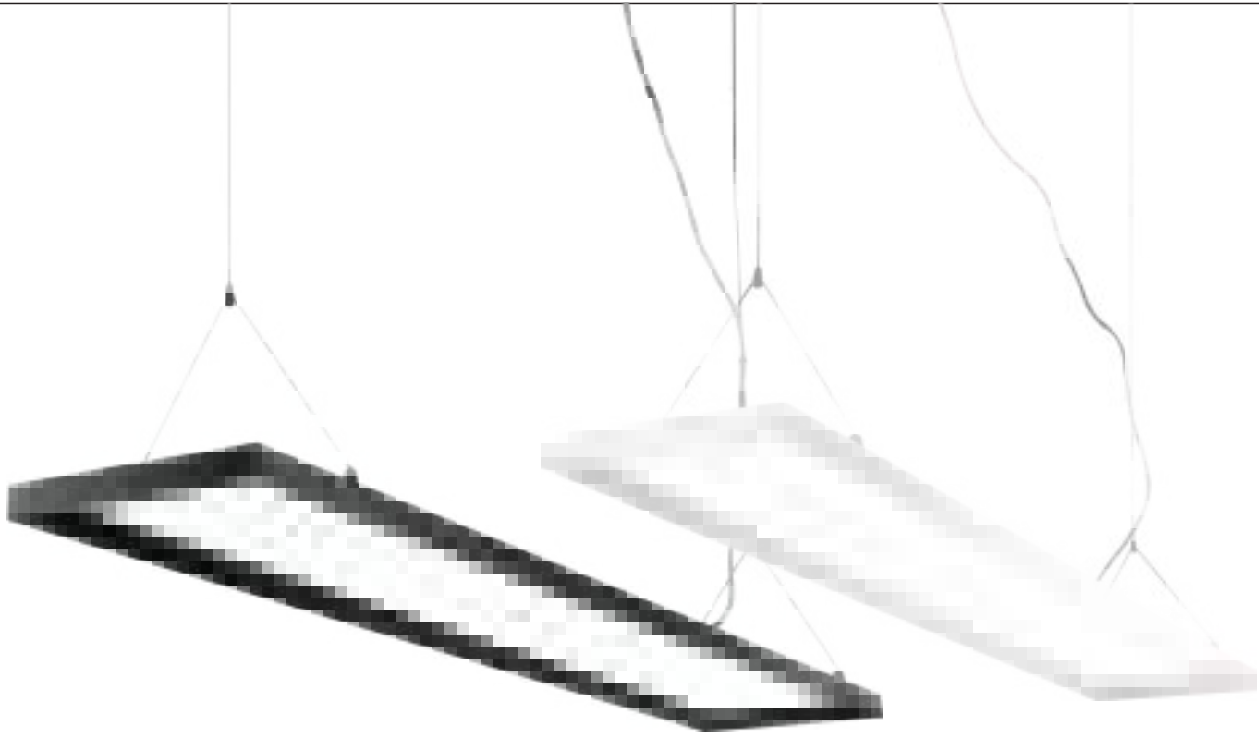

- LED Panel light for office pendant
- 1.2M long and 20cm width. The width of the lamp can be custom made to be 25mm or 30mm
- 40W gives 4000lm before acrylic
- supplied with 1.2m hanging cable, electric wire, and connecting box
- supper slim lamp body, soft and even light emission. Nice for the meeting room and other public space





 IP20

code	casing	finishing	lamping	CRI	lumen	diffuser	LED color
LQL003-WT	aluminum	white paint	SMD 40W	Ra>80	4000lm	Acrylic	2700K/3000K /4000K/6000K
LQL003-BK	aluminum	black paint	SMD 40W	Ra>80	4000lm	Acrylic	2700K/3000K /4000K/6000K

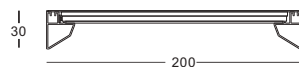

surface default

-  white paint similar to RAL9003
-  black paint equal to RAL9011

surface customizable

-  concrete grey paint similar to RAL7037





# LED OFFICE PENDANT

lens available

surface customizable  white paint similar to RAL9003  concrete grey paint similar to RAL7037

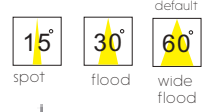

- big shielding angle by the outer casing
- lamp head can be rotatable freely good projector for wall paint or other places need key lighting
- lens angle 15/30/60 degree optional
- length of the lamp and numbers of the lamp head can be custom made according to the real requirements

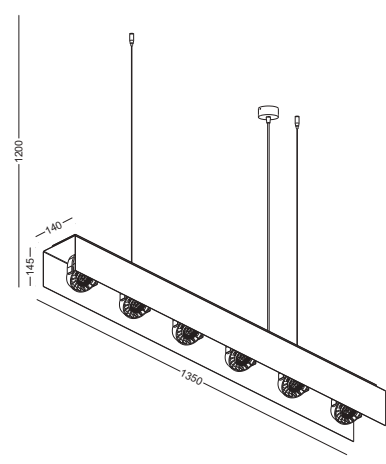
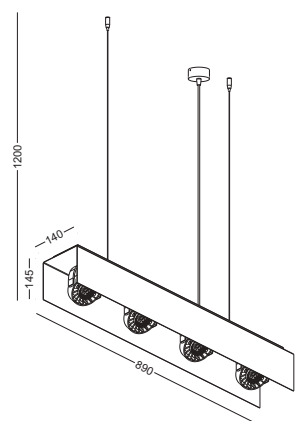
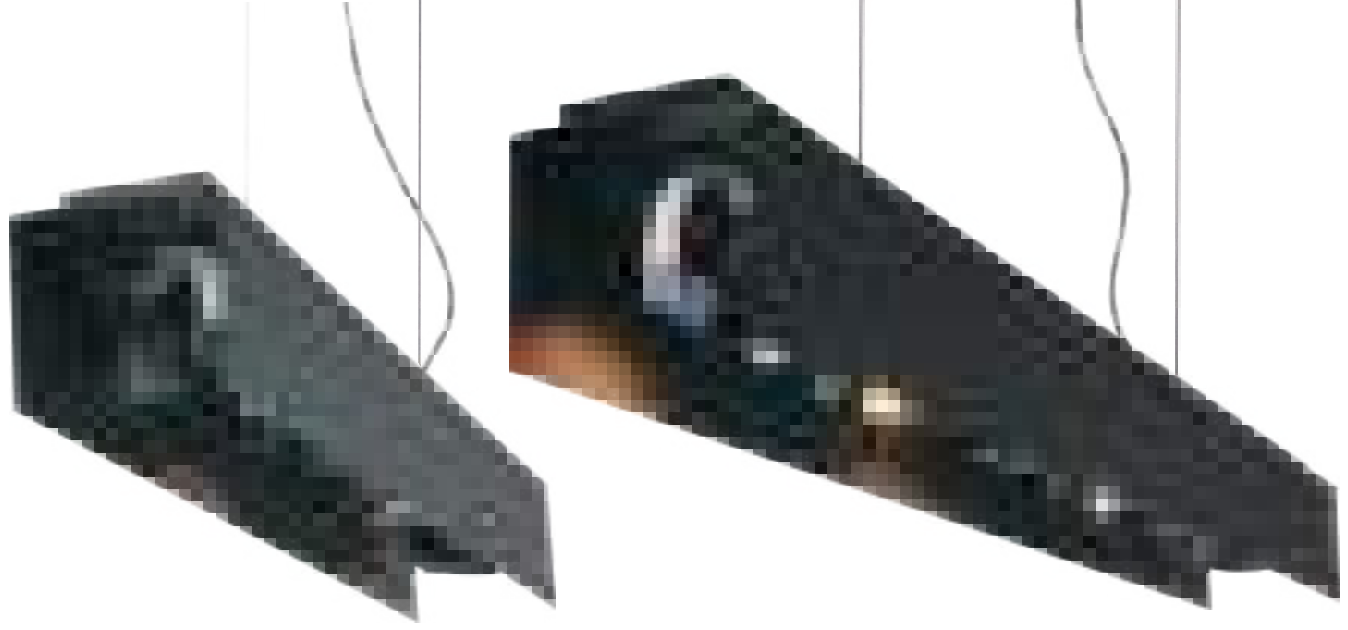

- size of the lamp head is dia100mm
- power-supplies are settled in the outer casing
- supplied with 1.2m hanging cable and electrical cable

code	casing	finishing	lamping	CRI	lumen	Beam/degree	LED color	Installation
LPL210	aluminum lamp head steel outer casing	black paint	LED 4X6W	Ra>80	1680lm	15 / 30 / 60	2700K/3000K /4000K/6000K	☐ ⊕ CE ▽ IP20
LPL211	aluminum lamp head steel outer casing	black paint	LED 6X6W	Ra>80	2520lm	15 / 30 / 60	2700K/3000K /4000K/6000K	☐ ⊕ CE ▽ IP20

# LED OFFICE PENDANT / LED HIGH BAY

reflector available

surface customizable

■ concrete grey paint similar to RAL7037

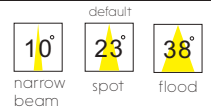

- solid aluminum heat sink /steel lamp shade
- good heat management / up to 42Watt / 3360lm
- supplied with 2m hanging chain and electrical cable

- lamp power 20/24/28/32/36/42W optional 20/24/28W are good for office lighting,while 32/36/42W are good for super market,retail shop ,restaurant,factory and etc.

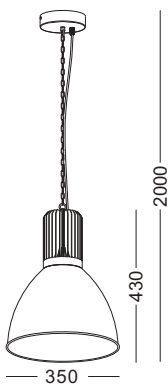

■ Ⓢ CE IP20

code	finishing	lamping	CRI	lumen	Beam/degree	LED color
LPL311-BK-20W	black paint	CREE COB 1816 20W	Ra>90	1600lm	10 / 23 / 38	2700K/3000K/4000K/6000K
LPL311-BK-24W	black paint	CREE COB 1816 24W	Ra>90	1920lm	10 / 23 / 38	2700K/3000K/4000K/6000K
LPL311-BK-28W	black paint	CREE COB 1816 28W	Ra>90	2240lm	10 / 23 / 38	2700K/3000K/4000K/6000K
LPL311-BK-32W	black paint	CREE COB 1820 32W	Ra>90	2560lm	10 / 23 / 38	2700K/3000K/4000K/6000K
LPL311-BK-36W	black paint	CREE COB 2530 36W	Ra>90	2880lm	10 / 23 / 38	2700K/3000K/4000K/6000K
LPL311-BK-42W	black paint	CREE COB 2530 42W	Ra>90	3360lm	10 / 23 / 38	2700K/3000K/4000K/6000K
LPL311-WT-20W	white paint	CREE COB 1816 20W	Ra>90	1600lm	10 / 23 / 38	2700K/3000K/4000K/6000K
LPL311-WT-24W	white paint	CREE COB 1816 24W	Ra>90	1920lm	10 / 23 / 38	2700K/3000K/4000K/6000K
LPL311-WT-28W	white paint	CREE COB 1816 28W	Ra>90	2240lm	10 / 23 / 38	2700K/3000K/4000K/6000K
LPL311-WT-32W	white paint	CREE COB 1820 32W	Ra>90	2560lm	10 / 23 / 38	2700K/3000K/4000K/6000K
LPL311-WT-36W	white paint	CREE COB 2530 36W	Ra>90	2880lm	10 / 23 / 38	2700K/3000K/4000K/6000K
LPL311-WT-42W	white paint	CREE COB 2530 42W	Ra>90	3360lm	10 / 23 / 38	2700K/3000K/4000K/6000K

# LED OFFICE PENDANT / LED HIGH BAY

reflector available

surface customizable

- black paint equal to RAL9011
- concrete grey paint similar to RAL7037
- white paint similar to RAL9003
- anodized gold brushed circular

reflector available

15° narrow beam	24° spot	38° flood
--------------------	-------------	--------------

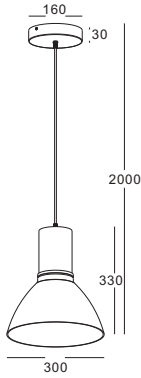

- aluminum heat sink
- crystal glass lamp shade
- default anodized silver finish four more finishes can be custom make
- 15/24/38 degree reflector optional
- supplied with 2m hanging cable
- good for office, retail shop, restaurant, café shop, and etc.



code LPL301

casing aluminum casing / crystal glass lamp shade / anodized silver / lamping COB 20W / Ra>90 / 1600LM / Beam 13/24/38 degree / 2700K/3000K / 4000K/6000K

installation IP20 lamp shade dia300mm x 160mm 2meter cable / cable length customizable

# LED OFFICE PENDANT / LED HIGH BAY

reflector available

surface customizable

■ concrete grey paint similar to RAL7037

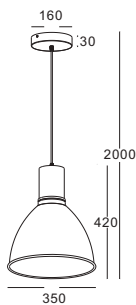
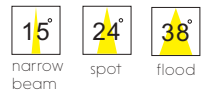

- aluminum heat sink  
steel lamp shade
- default five colors finish  
black/white/red/green/  
yellow
- 15/24/38 degree reflector  
optional
- supplied with 2m hanging cable
- good for office, retail shop,  
restaurant, café shop, and etc.

code LPL302-BK / LPL302-WT

casing aluminum casing / black paint / lamping COB 20W / Ra>90 / 1600LM / Beam 15/24/38 degree / steel lamp shade / white paint

2700K/3000K /4000K/6000K

installation ■ Ⓢ CE ▽ IP20 lamp shade dia 350mm x 250mm 2meter cable / cable length customizable

# LED OFFICE PENDANT / LED HIGH BAY

reflector available

surface customizable

■ concrete grey paint similar to RAL7037

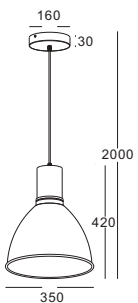
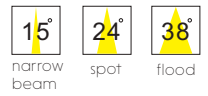

- aluminum heat sink  
steel lamp shade
- default five colors finish  
black/white/red/green/  
yellow
- 15/24/38 degree reflector  
optional
- supplied with 2m hanging cable
- good for office, retail shop,  
restaurant, café shop, and etc.

code LPL302-GN / LPL302-YW / LPL302-RD

casing aluminum casing / green/yellow / lamping COB 20W / Ra>90 / 1600LM / Beam 15/24/38 degree / 2700K/3000K  
steel lamp shade / red paint / 4000K/6000K

installation ■ Ⓢ CE ▽ IP20 lamp shade dia 350mm x 250mm 2meter cable / cable length customizable



# LED OFFICE PENDANT

reflector available

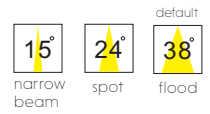

code LPL119

surface customizable  black paint equal to RAL9011  concrete grey paint similar to RAL7037

casing aluminum / white paint / lamping COB 5W / Ra>90 / 430LM / Beam 15/24/38 degree / 2700K/3000K/4000K/6000K

installation     IP20 lamp shade dia 60mm x 100mm 1meter cable / cable length customizable

code LPL120

surface customizable  black paint equal to RAL9011  concrete grey paint similar to RAL7037

casing aluminum / white paint / lamping COB 12W / Ra>90 / 900LM / Beam 15/24/38 degree / 2700K/3000K/4000K/6000K

installation     IP20 lamp shade dia 102mm x 100mm 1meter cable / cable length customizable

# LED OFFICE PENDANT

lens available

surface customizable

■ concrete grey paint similar to RAL7037

■ black paint equal to RAL9011

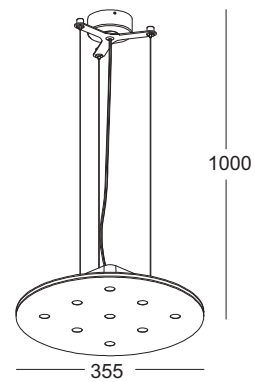
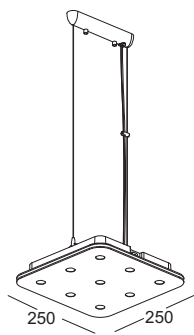
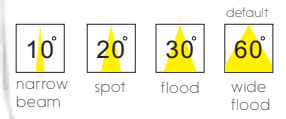





code	LPL 148
casing	aluminum / white painting
lamping	LED 9X3W / Ra>80 / 1080LM
Beam	10 / 20 / 30 / <b>60</b> degree
	2700K/ <b>3000K</b> /4000K/6000K
Installation	

code	LPL 147
casing	aluminum / white painting
lamping	LED 9X3W / Ra>80 / 1080LM
Beam	10 / 20 / 30 / <b>60</b> degree
	2700K/ <b>3000K</b> /4000K/6000K
Installation	







# LED OFFICE PENDANT



	<p>code LPL139-WT / LPL139-BK          casing aluminum / white/black painting          lamping LED 6x2W / Ra&gt;80 / 600LM          Beam 10 / 20 / <b>30</b> / 60 degree          2700K / <b>3000K</b> / 4000K / 6000K</p>	<p>surface customizable</p> <p> concrete grey paint similar to RAL7037</p>	<p>lens available</p> <p> narrow beam</p> <p> spot</p> <p> flood</p> <p> wide flood</p> <p>default <b>30°</b></p>
--	--	---	---

# LED OFFICE PENDANT



	<p>code LPL 140-WT / LPL 140-BK          casing aluminum / white/black painting          lamping LED 2x6x2W / Ra&gt;80 / 1200LM          Beam 10 / 20 / <b>30</b> / 60 degree          2700K / <b>3000K</b> / 4000K / 6000K</p>	<p>surface customizable</p> <p> concrete grey paint similar to RAL7037</p>	<p>lens available</p> <p> <b>10°</b> narrow beam</p> <p> 20° spot</p> <p> <b>30°</b> flood</p> <p> 60° wide flood</p> <p><small>default</small></p>
--	---	---	---

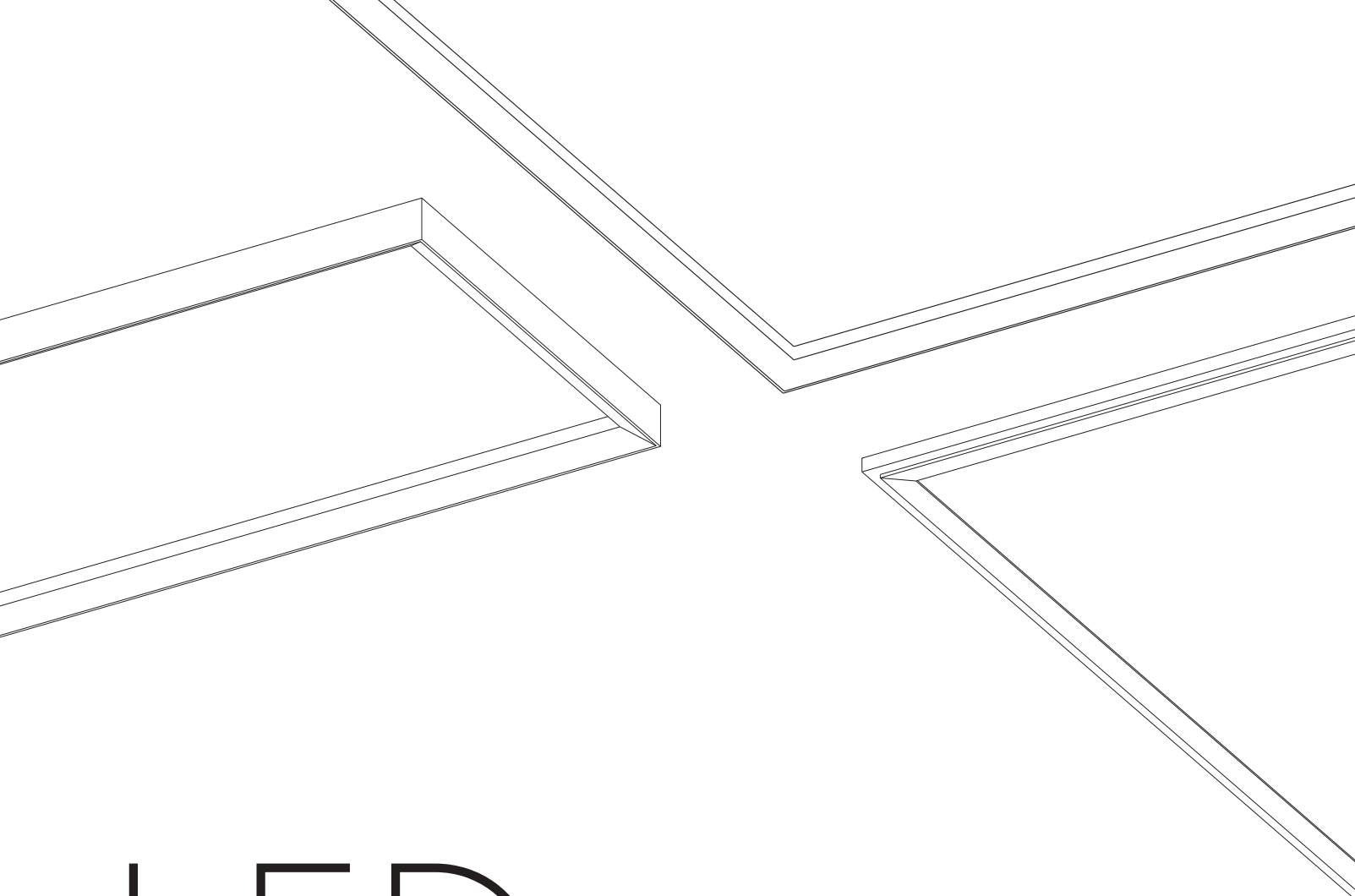

LED  
PANEL  
LIGHT

The LED panel light become a type of fasion recently,because of its slim lamp body,easy installation,low power consumption and low cost maintenance.

It's a trend that the LED panel will take the place of the fluorescent grille light for office lighting. And now we have seen this picutre and we have done something.





We design this series to make it unique to other LED panel from suppliers in the market.

The difference is the solid looking shape of the extrusion,and 48W power.It gives as much as 3840lm soft and even light.

Every pakage will be supplied with all components for three types of installation:hanging,recessed, laying.





 <p>    </p>	<p> code LQL001-BK / LQL001-WT / LQL001-SL  casing aluminum / black / white / silver painting  lamping SMD 48W / Ra&gt;80 / 3840LM  Beam Acrylic diffuser  2700K/3000K/4000K/6000K  installation check installation guide </p>	<p> Hanging Installation/  Laying Down Installation/  Spring Clip Installation  Supplied With  All Installation  Accessories </p>	<p> surface  customizable   concrete grey paint  similar to RAL7037 </p>
--	--	---	---

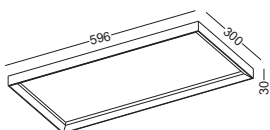





 IP20

code LQL002-BK / LQL002-WT / LQL002-SL  
 casing aluminum / black / white / silver painting  
 lamping SMD 24W / Ra>80 / 1920LM  
 Beam Acrylic diffuser  
 2700K/3000K/4000K/6000K

installation check installation guide

Hanging Installation/  
 Laying Down Installation/  
 Spring Clip Installation  
 Supplied With  
 All Installation  
 Accessories

surface customizable



 concrete grey paint  
 similar to RAL7037

## LQL001 / LQL002 installation guide

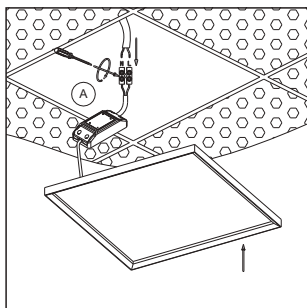
---

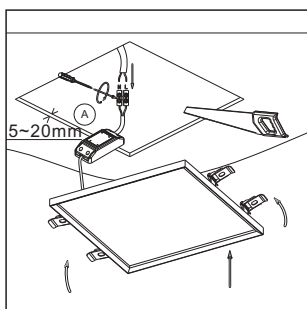

- installed on a 600x600 grille ceiling
  1. switch off the main
  2. connect the power-supply to the main
  3. connect the led panel to the diver with connector
  4. put the panel to the ceiling from one side to the other



- installed on normal wooden ceiling
  1. cut a square hole on the ceiling  
580x580mm for LQL001 series  
580x280mm for LQL002 series
  2. switch off the main
  2. connect the power-supply to the main
  3. connect the led panel to the diver with connector
  4. reverse the spring and put the panel to the ceiling

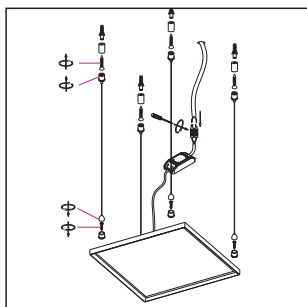

- Hanging installation for LQL001/LQL002
  1. find the accessory package,  
fix the four nuts to the panel,  
measure the distance between nuts,  
fix the hanging cable to the ceiling accordingly
  2. switch off the main
  2. connect the power-supply to the main
  3. connect the led panel to the diver with connector
  4. adjust the height of the panel.







SLIM FIT LED PANNEL LIGHT FOR OFFICE ROOFS 600x600MM



SLIM FIT LED PANNEL LIGHT FOR OFFICE ROOFS 600x300MM

<p> </p>	<p>code LQL014-WT  casing aluminum / white painting  lamping SMD 48W / Ra&gt;80 / 3840LM  Beam Acrylic diffuser  2700K/3000K/4000K/6000K</p> <p>installation check installation guide</p>	<p>installed on a 600x600 grille ceiling</p>	<p>surface customizable</p> <ul style="list-style-type: none"> <li> concrete grey paint similar to RAL7037</li> <li> black paint equal to RAL9011</li> </ul>
----------	---	--	--

<p> </p>	<p>code LQL013-WT  casing aluminum / white painting  lamping SMD 24W / Ra&gt;80 / 1920LM  Beam Acrylic diffuser  2700K/3000K/4000K/6000K</p> <p>installation check installation guide</p>	<p>installed on a 600x300 grille ceiling</p>	<p>surface customizable</p> <ul style="list-style-type: none"> <li> concrete grey paint similar to RAL7037</li> <li> black paint equal to RAL9011</li> </ul>
----------	---	--	--

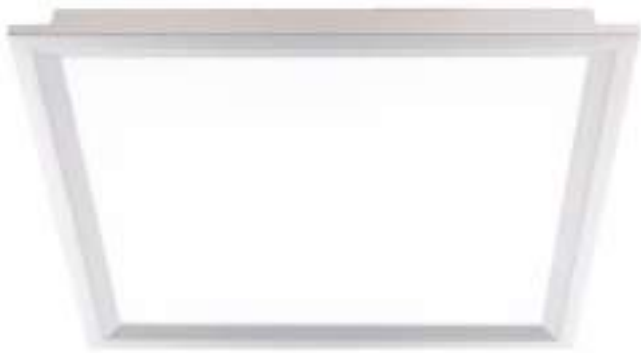

LED PANEL LIGHT  
SPECIALY  
FOR KITCHEN  
OR BATH ROOF  
300X300MM  
AND 600X300MM

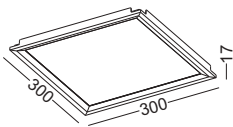
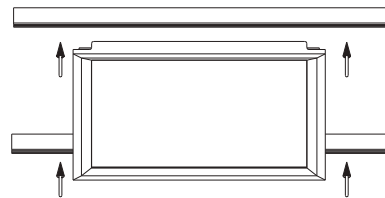
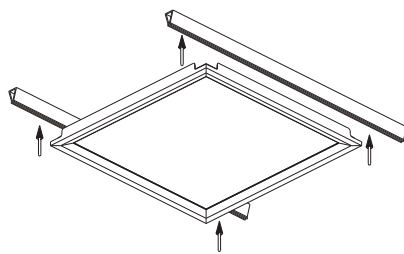

CE IP20

code LQL011-SL  
casing aluminum / Anodized silver  
lamping SMD 12W / Ra>80 / 1200LM  
Beam Acrylic diffuser  
2700K/3000K/4000K/6000K  
installation check installation guide

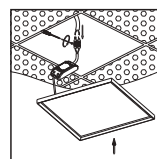

installed on a  
kitchen/bathroom  
300x300 grille  
ceiling by tighten  
up the keel

surface  
customizable

■ concrete grey paint  
similar to RAL7037  
■ white paint  
similar to RAL9003

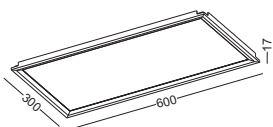

CE IP20

code LQL012-SL  
casing aluminum / Anodized silver  
lamping SMD 24W / Ra>80 / 2400LM  
Beam Acrylic diffuser  
2700K/3000K/4000K/6000K  
installation check installation guide

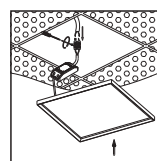

installed on a  
kitchen/bathroom  
600x300 grille  
ceiling by tighten  
up the keel

surface  
customizable

■ concrete grey paint  
similar to RAL7037  
■ white paint  
similar to RAL9003



LED  
SPOT  
LIGHTS  
SURFACE  
MOUNT

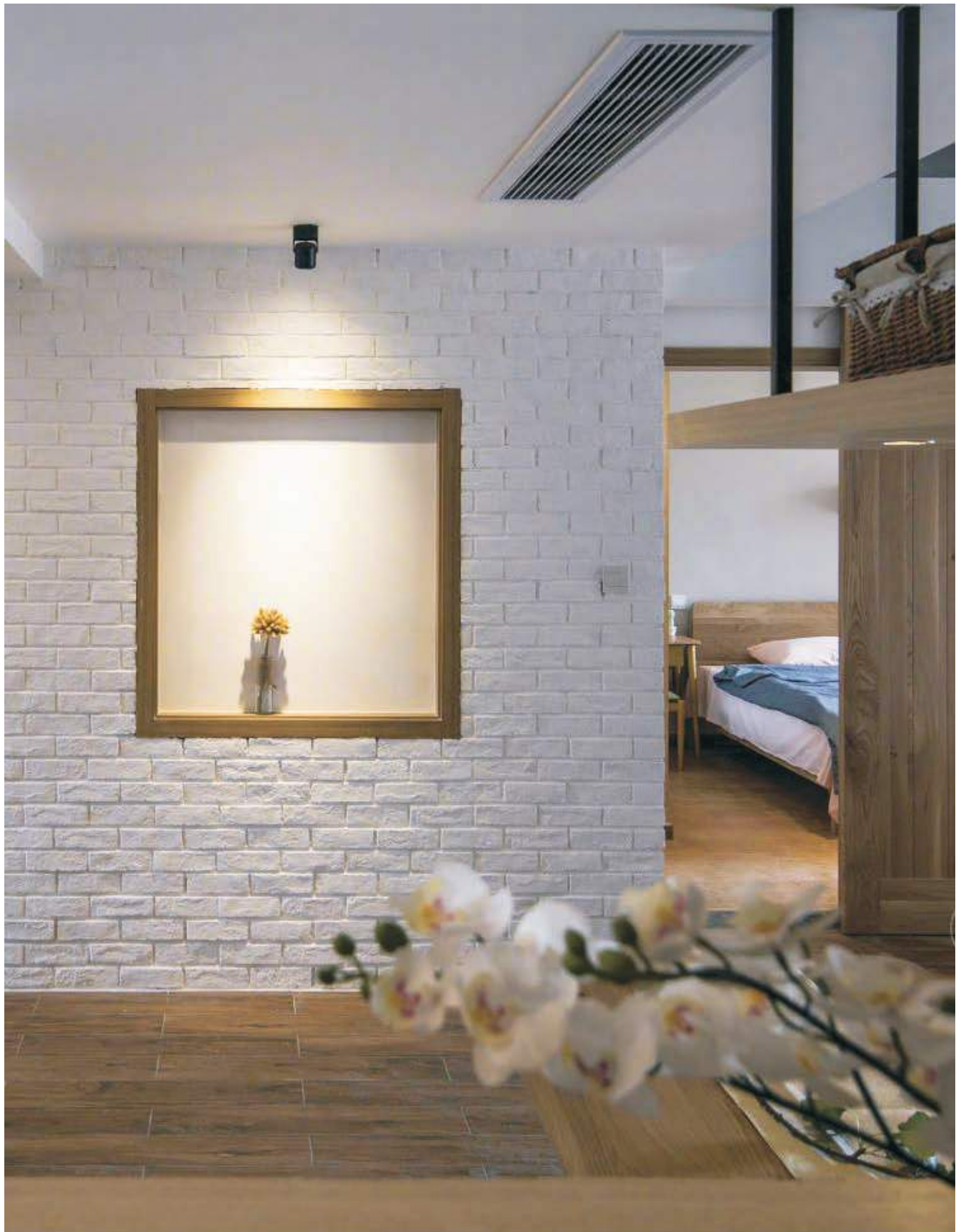



code **LSP180-WT**  
 casing aluminum / white painting  
 lamping COB 5W / Ra>90 / 430LM  
 Beam 10/23/38 degree /  
 2700K/3000K/4000K/6000K  
 installation IP20  
 TRIAC dimming driver customizable  
 Check photometric on page001

surface customizable  
 black paint equal to RAL9011  
 concrete grey paint similar to RAL7037

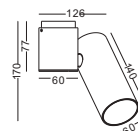

code **LSP180-SL**  
 casing aluminum / anodized silver  
 lamping COB 5W / Ra>90 / 430LM  
 Beam 10/23/38 degree /  
 2700K/3000K/4000K/6000K  
 installation IP20  
 TRIAC dimming driver customizable  
 Check photometric on page001

surface customizable  
 black paint equal to RAL9011  
 concrete grey paint similar to RAL7037

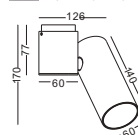

code **LSP180-GD**  
 casing aluminum / anodized gold  
 lamping COB 5W / Ra>90 / 430LM  
 Beam 10/23/38 degree /  
 2700K/3000K/4000K/6000K  
 installation IP20  
 TRIAC dimming driver customizable  
 Check photometric on page001

surface customizable  
 black paint equal to RAL9011  
 concrete grey paint similar to RAL7037

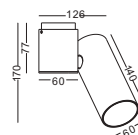



# LED SPOT LIGHT SURFACE MOUNT

code **LSP181-WT**

casing aluminum / white painting

lamping COB 9W / Ra>90 / 800LM

Beam 10/23/38 degree /  
2700K/3000K/4000K/6000K

installation     IP20

TRIAC dimming driver customizable  
Check photometric on page001

surface customizable

-  black paint equal to RAL9011
-  concrete grey paint similar to RAL7037

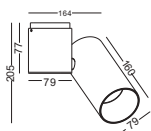

code **LSP181-SL**

casing aluminum / anodized silver

lamping COB 9W / Ra>90 / 800LM

Beam 10/23/38 degree /  
2700K/3000K/4000K/6000K

installation     IP20

TRIAC dimming driver customizable  
Check photometric on page001

surface customizable

-  black paint equal to RAL9011
-  concrete grey paint similar to RAL7037

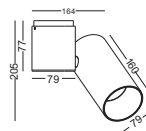

code **LSP181-GD**

casing aluminum / anodized gold

lamping COB 9W / Ra>90 / 800LM

Beam 10/23/38 degree /  
2700K/3000K/4000K/6000K

installation     IP20

TRIAC dimming driver customizable  
Check photometric on page001

surface customizable

-  black paint equal to RAL9011
-  concrete grey paint similar to RAL7037

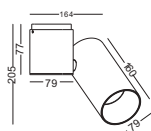

# LED SPOT LIGHT SURFACE MOUNT



code **LSP182-WT**  
 casing aluminum / white painting  
 lamping COB 12W / Ra>90 /900LM  
 Beam 10/23/38 degree /  
 2700K/3000K/4000K/6000K  
 installation IP20  
 TRIAC dimming driver customizable  
 Check photometric on page001

surface customizable

- black paint equal to RAL9011
- concrete grey paint similar to RAL7037



code **LSP182-SL**  
 casing aluminum / anodized silver  
 lamping COB 12W / Ra>90 /900LM  
 Beam 10/23/38 degree /  
 2700K/3000K/4000K/6000K  
 installation IP20  
 TRIAC dimming driver customizable  
 Check photometric on page001

surface customizable

- black paint equal to RAL9011
- concrete grey paint similar to RAL7037



code **LSP182-GD**  
 casing aluminum / anodized gold  
 lamping COB 12W / Ra>90 /900LM  
 Beam 10/23/38 degree /  
 2700K/3000K/4000K/6000K  
 installation IP20  
 TRIAC dimming driver customizable  
 Check photometric on page001

surface customizable

- black paint equal to RAL9011
- concrete grey paint similar to RAL7037



# LED SPOT LIGHT SURFACE MOUNT

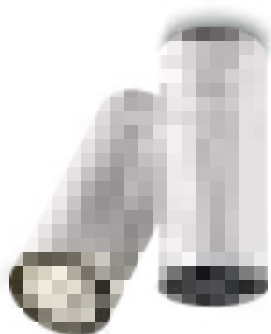

surface customizable

-  black paint equal to RAL9011
-  concrete grey paint similar to RAL7037

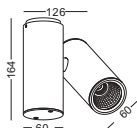

code **LSP125**

casing aluminum / white painting  
 lamping COB 5W / Ra>90 / 430LM  
 Beam 15/24/38/60 degree /  
 2700K/3000K/4000K/6000K

installation     IP20

TRIAC dimming driver customizable  
 Check photometric on page001



surface customizable

-  black paint equal to RAL9011
-  concrete grey paint similar to RAL7037

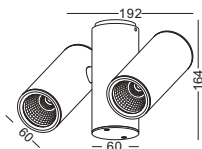

code **LSP126**

casing aluminum / white painting  
 lamping COB 2x5W / Ra>90 / 860LM  
 Beam 15/24/38/60 degree /  
 2700K/3000K/4000K/6000K

installation     IP20

TRIAC dimming driver customizable  
 Check photometric on page001



surface customizable

-  black paint equal to RAL9011
-  concrete grey paint similar to RAL7037

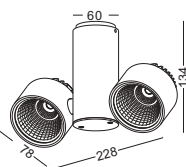

code **LSP128**

casing aluminum / white painting  
 lamping COB 2x9W / Ra>90 / 160LM  
 Beam 15/24/38/60 degree /  
 2700K/3000K/4000K/6000K

installation     IP20

TRIAC dimming driver customizable  
 Check photometric on page001

# LED SPOT LIGHT SURFACE MOUNT



surface customizable

- black paint equal to RAL9011
- concrete grey paint similar to RAL7037

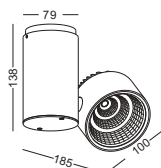

code **LSP129**

casing aluminum / white painting  
lampping COB 12W / Ra>90 /900LM  
Beam 15/24/38/60 degree /  
2700K/3000K/4000K/6000K

installation IP20

TRIAC dimming driver customizable  
Check photometric on page001

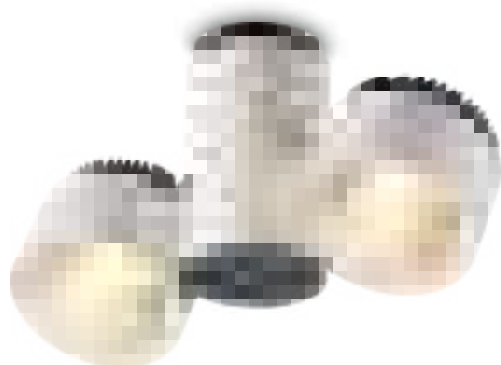

surface customizable

- black paint equal to RAL9011
- concrete grey paint similar to RAL7037

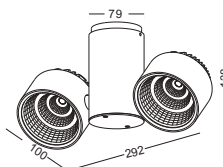

code **LSP130**

casing aluminum / white painting  
lampping COB 2x12W / Ra>90 /1800LM  
Beam 15/24/38/60 degree /  
2700K/3000K/4000K/6000K

installation IP20

TRIAC dimming driver customizable  
Check photometric on page001

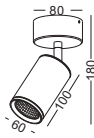

surface customizable

- black paint equal to RAL9011
- concrete grey paint similar to RAL7037

code **LBL051**

casing aluminum / white painting  
 lamping COB 5W / Ra>90 /430LM  
 Beam 15/24/38/60 degree /  
 2700K/3000K/4000K/6000K

installation IP20  
 TRIAC dimming driver customizable  
 Check photometric on page001

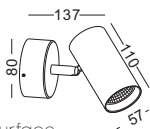

surface customizable

- anodized gold brushed circular
- concrete grey paint similar to RAL7037

code **LWA187-WT**

casing aluminum / white painting  
 lamping COB 5W / Ra>90 /430LM  
 Beam 15/24/38/60 degree /  
 2700K/3000K/4000K/6000K

installation IP20  
 TRIAC dimming driver customizable  
 Check photometric on page001



code **LWA187-BK**

casing aluminum / black painting  
 lamping COB 5W / Ra>90 /430LM  
 Beam 15/24/38/60 degree /  
 2700K/3000K/4000K/6000K

installation IP20  
 TRIAC dimming driver customizable  
 Check photometric on page001



code **LSP164-WT**

casing aluminum / white painting

lampping COB 2x5W / Ra>90 / 860LM

Beam 15/24/38/60 degree /  
2700K/3000K/4000K/6000K

installation     IP20

TRIAC dimming driver customizable  
Check photometric on page001



code **LSP164-BK**

casing aluminum / black painting

lampping COB 2x5W / Ra>90 / 860LM

Beam 15/24/38/60 degree /  
2700K/3000K/4000K/6000K

installation     IP20

TRIAC dimming driver customizable  
Check photometric on page001



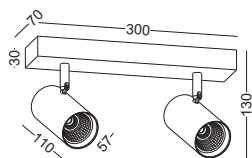

surface  
customizable

 anodized gold  
brushed circular

 concrete grey paint  
similar to RAL7037





code **LSP165-WT**  
 casing aluminum / white painting  
 lamping COB 3x5W / Ra>90 / 1290LM  
 Beam 15/24/38/60 degree /  
 2700K/3000K/4000K/6000K  
 installation     IP20  
 TRIAC dimming driver customizable  
 Check photometric on page001



surface  
 customizable

-  anodized gold  
brushed circular
-  concrete grey paint  
similar to RAL7037

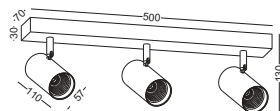

code **LSP165-BK**  
 casing aluminum / black painting  
 lamping COB 3x5W / Ra>90 / 1290LM  
 Beam 15/24/38/60 degree /  
 2700K/3000K/4000K/6000K  
 installation     IP20  
 TRIAC dimming driver customizable  
 Check photometric on page001



code **LSP168**

casing aluminum / white painting

lamping COB 5W / Ra>90 /430LM

Beam 10/23/38 degree /

2700K/3000K/4000K/6000K

installation     IP20

TRIAC dimming driver customizable

Check photometric on page001

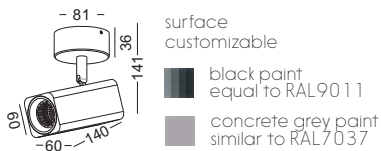

code **LSP171**

casing aluminum / white painting

lamping COB 12W / Ra>90 /900LM

Beam 10/23/38 degree /

2700K/3000K/4000K/6000K

installation     IP20

TRIAC dimming driver customizable

Check photometric on page001

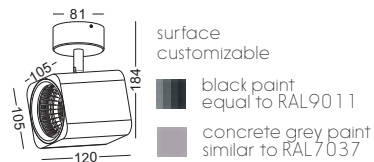



code **LSP170**  
 casing aluminum / white painting  
 lamping COB 3X5W / Ra>90 / 1290LM  
 Beam 10/23/38 degree /  
 2700K/3000K/4000K/6000K  
 installation     IP20  
 TRIAC dimming driver customizable  
 Check photometric on page001



code **LSP169**  
 casing aluminum / white painting  
 lamping COB 2X5W / Ra>90 / 860LM  
 Beam 10/23/38 degree /  
 2700K/3000K/4000K/6000K  
 installation     IP20  
 TRIAC dimming driver customizable  
 Check photometric on page001

surface customizable

-  black paint equal to RAL9011
-  concrete grey paint similar to RAL7037

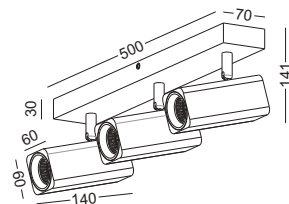
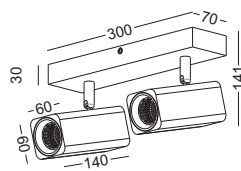

code **LSP172**  
 casing aluminum / white painting  
 lamping COB 2X12W / Ra>90 / 1800LM  
 Beam 10/23/38 degree /  
 2700K/3000K/4000K/6000K  
 installation     IP20  
 TRIAC dimming driver customizable  
 Check photometric on page001



code **LSP173**  
 casing aluminum / white painting  
 lamping COB 3X12W / Ra>90 / 2700LM  
 Beam 10/23/38 degree /  
 2700K/3000K/4000K/6000K  
 installation     IP20  
 TRIAC dimming driver customizable  
 Check photometric on page001

surface customizable

-  black paint equal to RAL9011
-  concrete grey paint similar to RAL7037

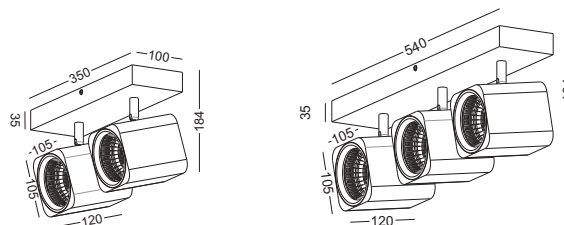



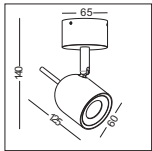

surface customizable  
 white paint similar to RAL9003  
 concrete grey paint similar to RAL7037

code **LSP210**  
 casing aluminum / black painting  
 lamping COB 5W / Ra>90 / 430LM  
 Beam **10**/23/38 degree /  
 2700K/**3000K**/4000K/6000K  
 installation IP20  
 TRIAC dimming driver customizable  
 Check photometric on page001

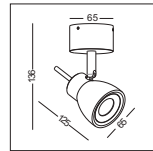

surface customizable  
 white paint similar to RAL9003  
 concrete grey paint similar to RAL7037

code **LSP211**  
 casing aluminum / black painting  
 lamping COB 5W / Ra>90 / 430LM  
 Beam **10**/23/38 degree /  
 2700K/**3000K**/4000K/6000K  
 installation IP20  
 TRIAC dimming driver customizable  
 Check photometric on page001

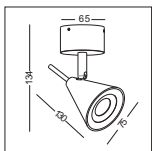

surface customizable  
 white paint similar to RAL9003  
 concrete grey paint similar to RAL7037

code **LSP212**  
 casing aluminum / black painting  
 lamping COB 5W / Ra>90 / 430LM  
 Beam **10**/23/38 degree /  
 2700K/**3000K**/4000K/6000K  
 installation IP20  
 TRIAC dimming driver customizable  
 Check photometric on page001

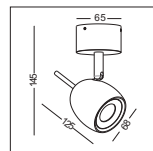

surface customizable  
 white paint similar to RAL9003  
 concrete grey paint similar to RAL7037

code **LSP213**  
 casing aluminum / black painting  
 lamping COB 5W / Ra>90 / 430LM  
 Beam **10**/23/38 degree /  
 2700K/**3000K**/4000K/6000K  
 installation IP20  
 TRIAC dimming driver customizable  
 Check photometric on page001

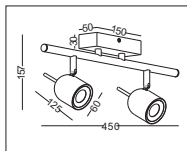

surface customizable

- white paint similar to RAL9003
- concrete grey paint similar to RAL7037

code **LSP214**

casing aluminum / black painting  
 lamping COB 2x5W / Ra>90 / 860LM  
 Beam **10**/23/38 degree /  
 2700K/**3000K**/4000K/6000K

installation IP20  
 TRIAC dimming driver customizable  
 Check photometric on page001

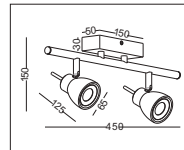

surface customizable

- white paint similar to RAL9003
- concrete grey paint similar to RAL7037

code **LSP215**

casing aluminum / black painting  
 lamping COB 2x5W / Ra>90 / 860LM  
 Beam **10**/23/38 degree /  
 2700K/**3000K**/4000K/6000K

installation IP20  
 TRIAC dimming driver customizable  
 Check photometric on page001

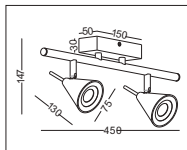

surface customizable

- white paint similar to RAL9003
- concrete grey paint similar to RAL7037

code **LSP216**

casing aluminum / black painting  
 lamping COB 2x5W / Ra>90 / 860LM  
 Beam **10**/23/38 degree /  
 2700K/**3000K**/4000K/6000K

installation IP20  
 TRIAC dimming driver customizable  
 Check photometric on page001

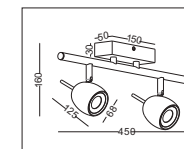

surface customizable

- white paint similar to RAL9003
- concrete grey paint similar to RAL7037

code **LSP217**

casing aluminum / black painting  
 lamping COB 2x5W / Ra>90 / 860LM  
 Beam **10**/23/38 degree /  
 2700K/**3000K**/4000K/6000K

installation IP20  
 TRIAC dimming driver customizable  
 Check photometric on page001

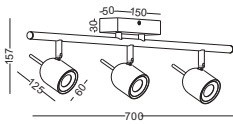

code **LSP218**

surface customizable  white paint similar to RAL9003  concrete grey paint similar to RAL7037

casing aluminum / black painting / lamping LED 3x5W / Ra>90 / 1270LM / Beam 10/23/38 degree / 2700K/3000K /4000K/6000K

installation IP20 TRIAC dimming driver customizable

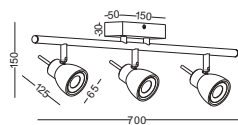

code **LSP219**

surface customizable  white paint similar to RAL9003  concrete grey paint similar to RAL7037

casing aluminum / black painting / lamping LED 3x5W / Ra>90 / 1270LM / Beam 10/23/38 degree / 2700K/3000K /4000K/6000K

installation IP20 TRIAC dimming driver customizable

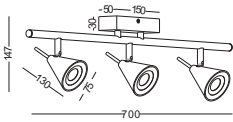

code **LSP220**

surface customizable  white paint similar to RAL9003  concrete grey paint similar to RAL7037

casing aluminum / black painting / lamping LED 3x5W / Ra>90 / 1270LM / Beam 10/23/38 degree / 2700K/3000K /4000K/6000K

installation     IP20 TRIAC dimming driver customizable

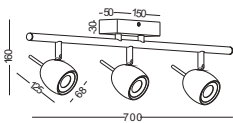

code **LSP221**

surface customizable  white paint similar to RAL9003  concrete grey paint similar to RAL7037

casing aluminum / black painting / lamping LED 3x5W / Ra>90 / 1270LM / Beam 10/23/38 degree / 2700K/3000K /4000K/6000K

installation     IP20 TRIAC dimming driver customizable

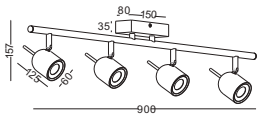

code **LSP222**

surface customizable  white paint similar to RAL9003  concrete grey paint similar to RAL7037

casing aluminum / black painting / lamping LED 4x5W / Ra>90 / 1720LM / Beam 10/23/38 degree / 2700K/3000K /4000K/6000K

installation IP20 TRIAC dimming driver customizable

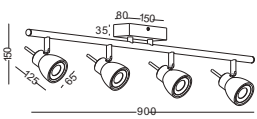

code **LSP223**

surface customizable  white paint similar to RAL9003  concrete grey paint similar to RAL7037

casing aluminum / black painting / lamping LED 4x5W / Ra>90 / 1720LM / Beam 10/23/38 degree / 2700K/3000K /4000K/6000K

installation IP20 TRIAC dimming driver customizable

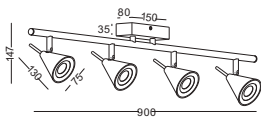

code **LSP224**

surface customizable  white paint similar to RAL9003  concrete grey paint similar to RAL7037

casing aluminum / black painting / lamping LED 4x5W / Ra>90 / 1720LM / Beam 10/23/38 degree / 2700K/3000K /4000K/6000K

installation     IP20 TRIAC dimming driver customizable

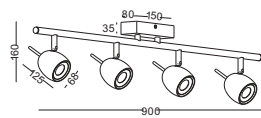

code **LSP225**

surface customizable  white paint similar to RAL9003  concrete grey paint similar to RAL7037

casing aluminum / black painting / lamping LED 4x5W / Ra>90 / 1720LM / Beam 10/23/38 degree / 2700K/3000K /4000K/6000K

installation     IP20 TRIAC dimming driver customizable

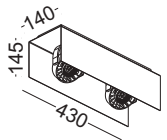

code **LSP161**

casing aluminum / black painting / lamping LED 2x6W / Ra>80 / 840LM / Beam 15/30/60 degree / 2700K/3000K/4000K/6000K

installation     IP20 no dimming driver available

surface customizable  white paint similar to RAL9003  concrete grey paint similar to RAL7037

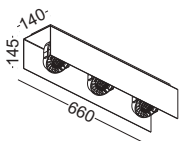

code **LSP162**

casing aluminum / black painting / lamping LED 3x6W / Ra>80 / 1260LM / Beam 15/30/60 degree / 2700K/3000K/4000K/6000K

installation     IP20 no dimming driver available

surface customizable  white paint similar to RAL9003  concrete grey paint similar to RAL7037

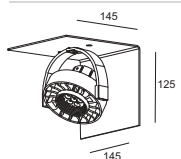

code **LBL080**

casing aluminum / black painting / lamping LED 6x2W / Ra>80 / 600LM / Beam 15/30/60 degree / 2700K/3000K/4000K/6000K

installation IP20 TRIAC dimming driver customizable / dia 55mm for putting driver into the ceiling

surface customizable white paint similar to RAL9003 concrete grey paint similar to RAL7037

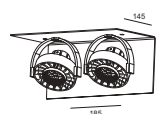

code **LBL081**

casing aluminum / black painting / lamping LED 2x6x2W / Ra>80 / 1200LM / Beam 15/30/60 degree / 2700K/3000K/4000K/6000K

installation IP20 TRIAC dimming driver customizable / dia 55mm for putting driver into the ceiling

surface customizable white paint similar to RAL9003 concrete grey paint similar to RAL7037

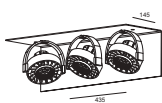

code **LBL082**

casing aluminum / black painting / lamping LED 3x6x2W / Ra>80 / 1800LM / Beam 15/30/60 degree / 2700K/3000K/4000K/6000K

installation IP20 TRIAC dimming driver customizable / dia 55mm for putting driver into the ceiling

surface customizable white paint similar to RAL9003 concrete grey paint similar to RAL7037



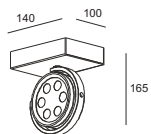
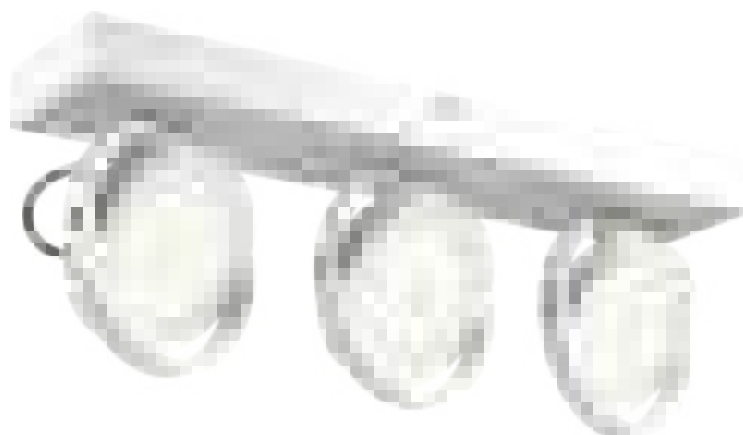

code **LSP071-WT**

surface customizable  black paint equal to RAL9011  concrete grey paint similar to RAL7037

casing aluminum / white painting / lamping LED 6W / Ra>80 / 420LM / Beam 10/20/30 degree / 2700K/3000K/4000K/6000K

installation     IP20 TRIAC / 0/1-10V / DALI dimming driver customizable

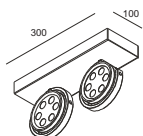

code **LSP072-WT**

surface customizable  black paint equal to RAL9011  concrete grey paint similar to RAL7037

casing aluminum / white painting / lamping LED 2x6W / Ra>80 / 840LM / Beam 10/20/30 degree / 2700K/3000K/4000K/6000K

installation     IP20 TRIAC / 0/1-10V / DALI dimming driver customizable

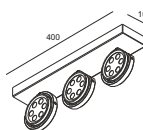

code **LSP073-WT**

surface customizable  black paint equal to RAL9011  concrete grey paint similar to RAL7037

casing aluminum / white painting / lamping LED 3x6W / Ra>80 / 1260LM / Beam 10/20/30 degree / 2700K/3000K/4000K/6000K

installation     IP20 TRIAC / 0/1-10V / DALI dimming driver customizable

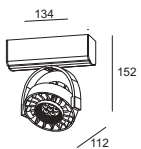
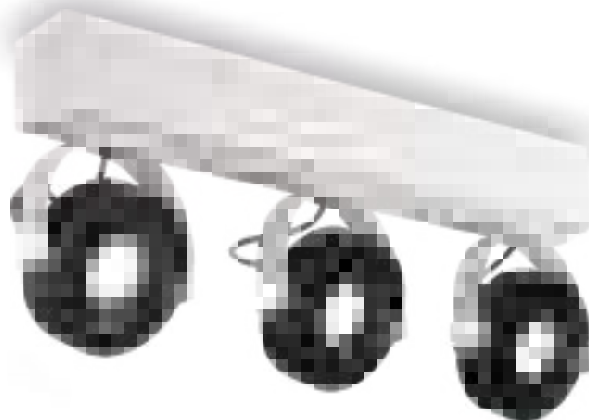
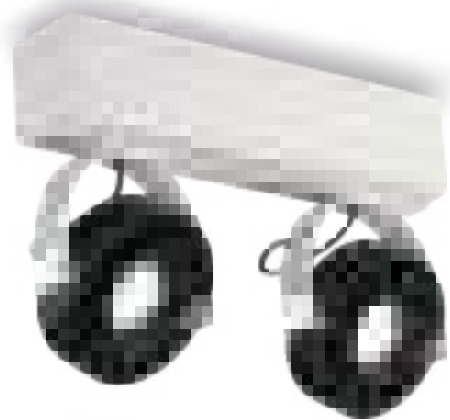

code **LBL077**

surface customizable  black paint equal to RAL9011  concrete grey paint similar to RAL7037

casing aluminum / white painting / lamping LED 12W / Ra>80 / 600LM / Beam 15/30/60 degree / 2700K/3000K/4000K/6000K

installation     IP20 TRIAC / 0/1-10V / DALI dimming driver customizable

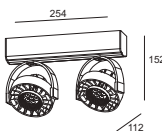

code **LSP078**

surface customizable  black paint equal to RAL9011  concrete grey paint similar to RAL7037

casing aluminum / white painting / lamping LED 24W / Ra>80 / 1200LM / Beam 15/30/60 degree / 2700K/3000K/4000K/6000K

installation     IP20 TRIAC / 0/1-10V / DALI dimming driver customizable

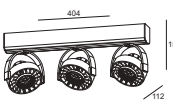

code **LSP079**

surface customizable  black paint equal to RAL9011  concrete grey paint similar to RAL7037

casing aluminum / white painting / lamping LED 36W / Ra>80 / 1800LM / Beam 15/30/60 degree / 2700K/3000K/4000K/6000K

installation     IP20 TRIAC / 0/1-10V / DALI dimming driver customizable

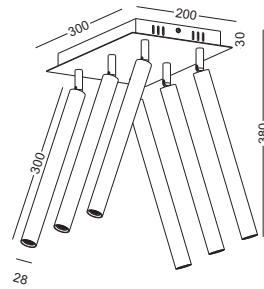
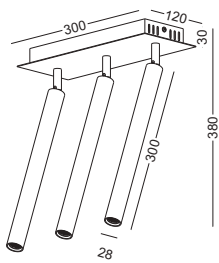

code **LBL199**

surface customizable  white paint similar to RAL9003  concrete grey paint similar to RAL7037

casing aluminum / black painting / lamping LED 3x3W / Ra>80 / 360LM / Beam 10/20/30 degree / 2700K/3000K/4000K/6000K

installation IP20 TRIAC / 0/1-10V / DALI dimming driver customizable

code **LBL200**

surface customizable  white paint similar to RAL9003  concrete grey paint similar to RAL7037

casing aluminum / black painting / lamping LED 6x3W / Ra>80 / 720LM / Beam 10/20/30 degree / 2700K/3000K/4000K/6000K

installation IP20 TRIAC / 0/1-10V / DALI dimming driver customizable

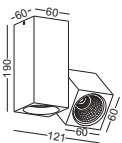

code **LBL121** surface customizable  white paint similar to RAL9003  concrete grey paint similar to RAL7037

casing aluminum / anodized black and silver / lamping COB 2x5W / Ra>90 / 860LM / Beam 15/24/38 degree / 2700K/3000K/4000K/6000K

installation     IP20 no dimming driver available

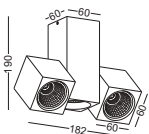

code **LBL122** surface customizable  white paint similar to RAL9003  concrete grey paint similar to RAL7037

casing aluminum / anodized black and silver / lamping COB 3x5W / Ra>90 / 1290LM / Beam 15/24/38 degree / 2700K/3000K/4000K/6000K

installation     IP20 no dimming driver available

LED TRACK



# LIGHTS





the secret of this series is the super slim track adopter. With the power-supply inside the cylinder of lamp body, the total lamp appears super slim, integral and pretty. The idea of this design is we just want a simplest track lamp beyond any complicated shape, just a cylinder on the track, nothing else. So we design the track adopter, put the power-supply in the cylinder, and make good heat management. Another advantage of this series is the big shielding angle up to 60 degree. It is very hard to see the led source even it lights straight down. It is a good series for home, store, museum, cafe, and etc. Just like a simple T-shirt, it can match almost any style of decoration. Three default finishing color, and four more custom made, three sizes and wattage. It could be a universal track light for any circumstance

SUPER SLIM LED TRACK SPOT LIGHT / 9W / DIA80MM VERSION

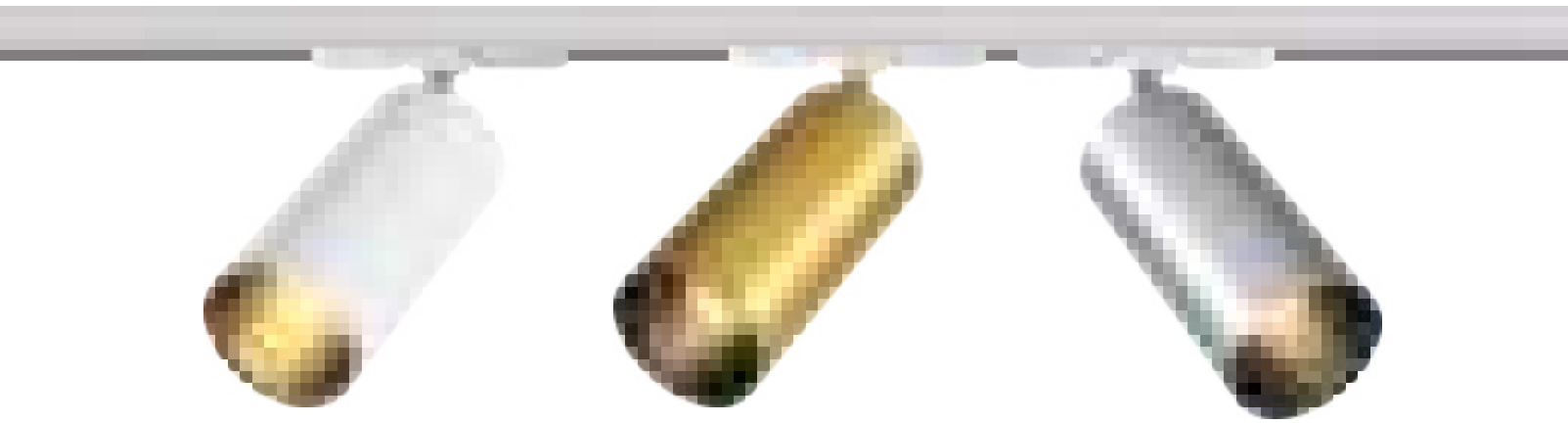

Super slim track adpater

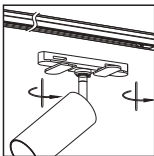

easy track installation fast and stable

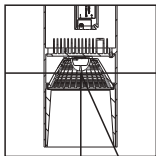

deep recessed reflector high shielding angle

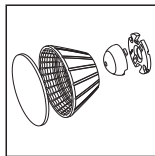

reflector + lens make perfect light 10/23/38 degree optional





SUPER SLIM LED TRACK SPOT LIGHT  
12W /DIA 102MM VERSION

DEFAULT 3 FINISHING COLOR AVAILABLE  
4 MORE FINISHING COLOR CUSTOM MADE

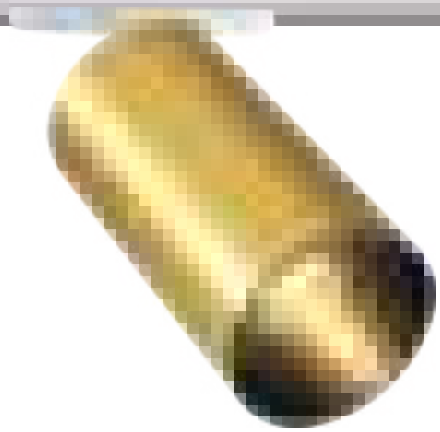

GOOD SERIES FOR HOME, MUSEUM,  
CAFÉ SHOP, RETAIL SHOP, AND ETC.

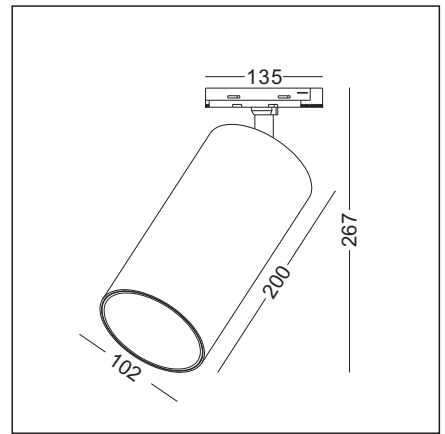
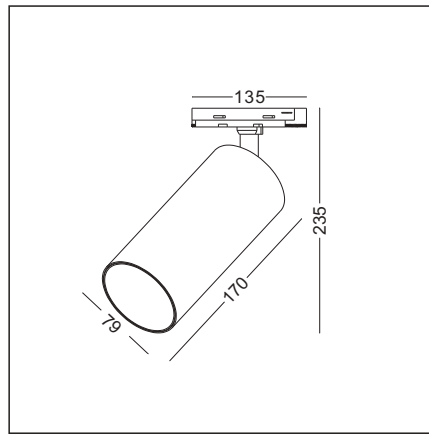
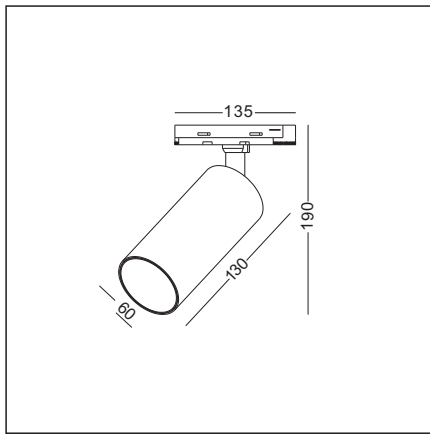

code LSP177-WT  
LSP177-GD  
LSP177-SL

casing aluminum  
finishing white paint  
anodized gold  
anodized silver  
lampping CREE COB 1304 / 5 Watt  
Lumens 430LM  
CRI Ra>90  
Beam 10 / 23 / 38  
lamp color 2700K/3000K/4000K/6000K  
Input AC 100-240V  
installation single circuit/2 line track



Net Weight 0.41kg

lens available

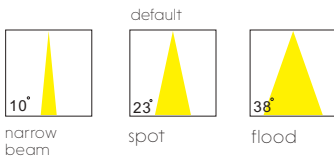

surface customizable

- anodized silver sandblasted
- black paint equal to RAL9011
- chrome plated
- concrete grey paint similar to RAL7037

code LSP178-WT  
LSP178-GD  
LSP178-SL

casing aluminum  
finishing white paint  
anodized gold  
anodized silver  
lampping CREE COB 1507 / 9 Watt  
Lumens 800LM  
CRI Ra>90  
Beam 10 / 23 / 38  
lamp color 2700K/3000K/4000K/6000K  
Input AC 100-240V  
installation single circuit/2 line track



Net Weight 0.7kg

lens available

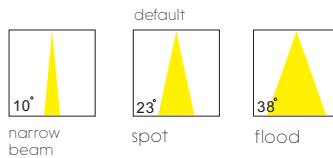

surface customizable

- anodized silver sandblasted
- black paint equal to RAL9011
- chrome plated
- concrete grey paint similar to RAL7037

code LSP179-WT  
LSP179-GD  
LSP179-SL

casing aluminum  
finishing white paint  
anodized gold  
anodized silver  
lampping CREE COB 1507 / 12 Watt  
Lumens 900LM  
CRI Ra>90  
Beam 10 / 23 / 38  
lamp color 2700K/3000K/4000K/6000K  
Input AC 100-240V  
installation single circuit/2 line track



Net Weight 1.07kg

lens available

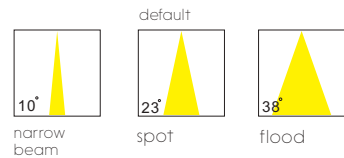

surface customizable

- anodized silver sandblasted
- black paint equal to RAL9011
- chrome plated
- concrete grey paint similar to RAL7037



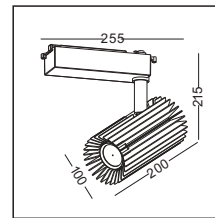
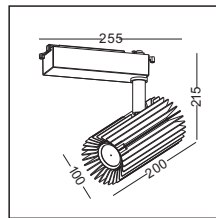
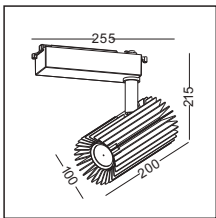

code LSP190-SL  
 casing aluminum  
 finishing anodized silver  
 lamping CREE COB 1512  
 20 Watt  
 Lumens 1600LM  
 CRI Ra>90  
 Beam 10 / 20 / 30  
 lamp color 2700K/3000K/4000K/6000K  
 Input AC 100-240V  
 installation single circuit/3 line track



Net Weight 1.26kg

lens available

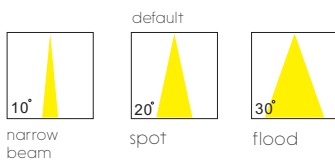

surface customizable  
 concrete grey paint similar to RAL7037  
 anodized gold sandblasted

code LSP190-BK  
 casing aluminum  
 finishing anodized black  
 lamping CREE COB 1512  
 20 Watt  
 Lumens 1600LM  
 CRI Ra>90  
 Beam 10 / 20 / 30  
 lamp color 2700K/3000K/4000K/6000K  
 Input AC 100-240V  
 installation single circuit/3 line track



Net Weight 1.26kg

lens available

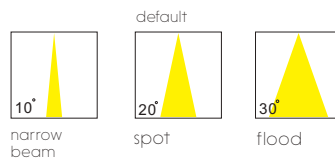

surface customizable  
 concrete grey paint similar to RAL7037  
 anodized gold sandblasted

code LSP190-WT  
 casing aluminum  
 finishing white coated  
 lamping CREE COB 1512  
 20 Watt  
 Lumens 1600LM  
 CRI Ra>90  
 Beam 10 / 20 / 30  
 lamp color 2700K/3000K/4000K/6000K  
 Input AC 100-240V  
 installation single circuit/3 line track



Net Weight 1.26kg

lens available

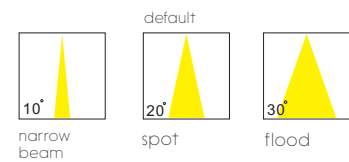

surface customizable  
 concrete grey paint similar to RAL7037  
 anodized gold sandblasted



# LED TRACK SPOT LIGHT

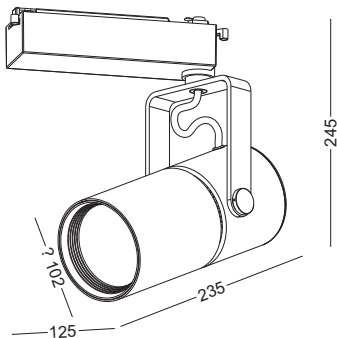
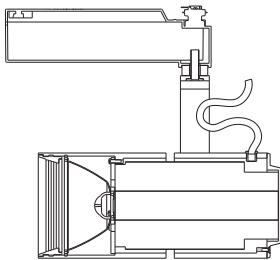
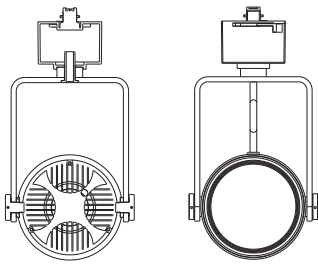

### General info

casing aluminum  
 CRI Ra >90  
 lamp color 2700K/3000K/4000K/6000K  
 installation 1 circuit / 3 line track

Net Weight 2.3kg

### lens available

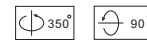
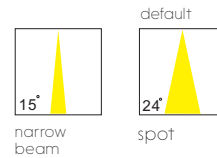

Order Code	surface	lamping	Lumen	beam angle
LSP176-SL-20W	anodized silver	CREE COB 1512 / 20W	1600 lm	15 / 24 degree
LSP176-WT-20W	white paint	CREE COB 1512 / 20W	1600 lm	15 / 24 degree
LSP176-BK-20W	black paint	CREE COB 1512 / 20W	1600 lm	15 / 24 degree
LSP176-SL-25W	anodized silver	CREE COB 1816 / 25W	2000 lm	15 / 24 degree
LSP176-WT-25W	white paint	CREE COB 1816 / 25W	2000 lm	15 / 24 degree
LSP176-BK-25W	black paint	CREE COB 1816 / 25W	2000 lm	15 / 24 degree
LSP176-SL-30W	anodized silver	CREE COB 1820 / 30W	2400 lm	15 / 24 degree
LSP176-WT-30W	white paint	CREE COB 1820 / 30W	2400 lm	15 / 24 degree
LSP176-BK-30W	black paint	CREE COB 1820 / 30W	2400 lm	15 / 24 degree

### surface default

- anodized silver brushed circular
- white paint similar to RAL9003
- black paint equal to RAL9011

### surface customizable

- concrete grey paint similar to RAL7037
- anodized gold brushed circular

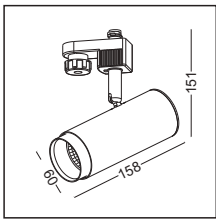

code LSP117  
 casing aluminum  
 finishing white paint  
 lamping COB 5W  
 Lumens 430LM  
 CRI Ra>90  
 Beam 15 / 24 / 38 / 60 degree  
 lamp color 2700K/3000K/4000K/6000K  
 Input AC 100-240V  
 installation single circuit/3 line track



IP20

Net Weight 0.42kg

reflector available

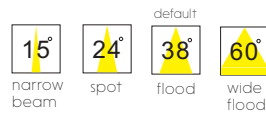

adjust shielding angle by turning in and out the black cover

surface customizable

- black paint equal to RAL9011
- concrete grey paint similar to RAL7037

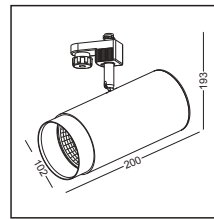

code LSP122  
 casing aluminum  
 finishing white paint  
 lamping COB 12W  
 Lumens 900LM  
 CRI Ra>90  
 Beam 15 / 24 / 38 / 60 degree  
 lamp color 2700K/3000K/4000K/6000K  
 Input AC 100-240V  
 installation single circuit/3 line track



IP20

Net Weight 1.08kg

reflector available

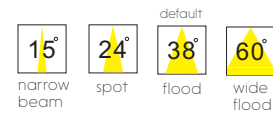

adjust shielding angle by turning in and out the black cover

surface customizable

- black paint equal to RAL9011
- concrete grey paint similar to RAL7037





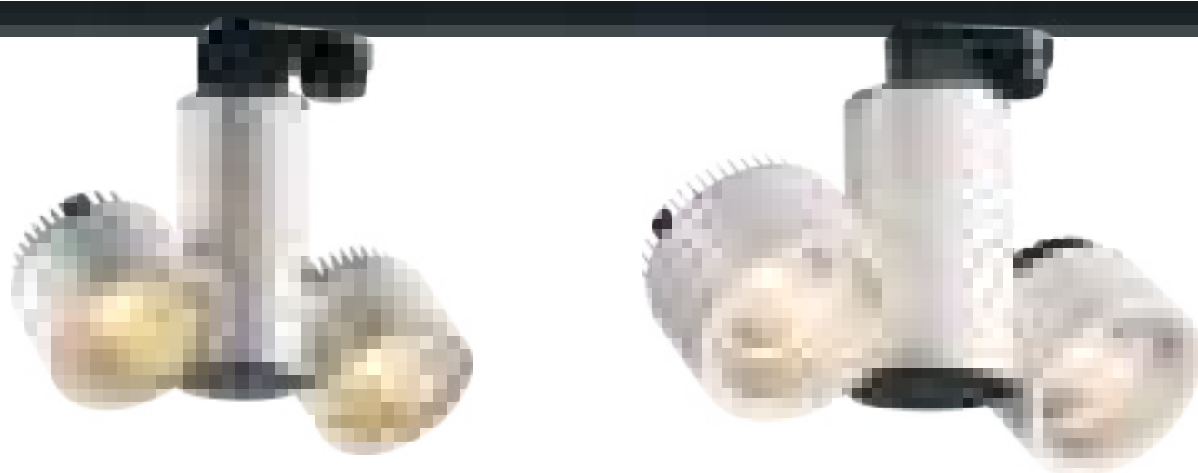

surface  
customizable

- black paint  
equal to RAL9011
- concrete grey paint  
similar to RAL7037

# LED TRACK SPOT LIGHT

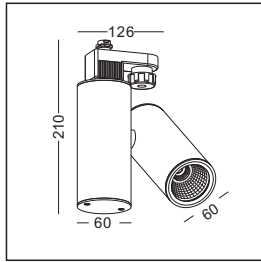

code	casing	finishing	lamping	CRI	lumen	Beam/degree	LED color
LSP115	aluminum	white paint	COB 5W	Ra>90	430lm	15 / 24 / 38 / 60	2700K/3000K /4000K/6000K
							reflector available 

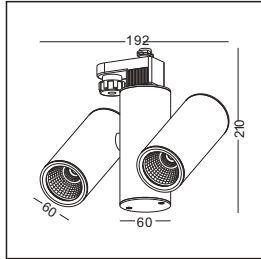

code	casing	finishing	lamping	CRI	lumen	Beam/degree	LED color
LSP116	aluminum	white paint	COB 2x5W	Ra>90	860lm	15 / 24 / 38 / 60	2700K/3000K /4000K/6000K
							reflector available 

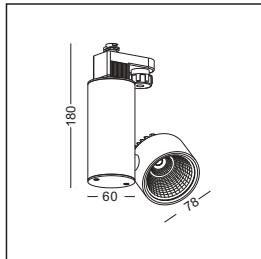

code	casing	finishing	lamping	CRI	lumen	Beam/degree	LED color
LSP118	aluminum	white paint	COB 9W	Ra>90	800lm	15 / 24 / 38 / 60	2700K/3000K /4000K/6000K
							reflector available 

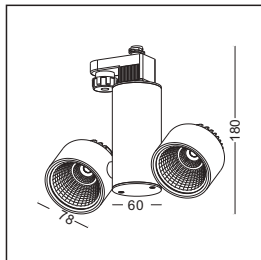

code	casing	finishing	lamping	CRI	lumen	Beam/degree	LED color
LSP119	aluminum	white paint	COB 2x9W	Ra>90	1600lm	15 / 24 / 38 / 60	2700K/3000K /4000K/6000K
							reflector available 

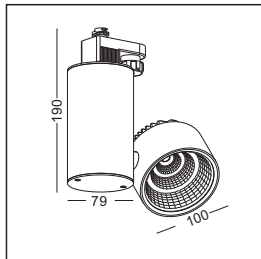

code	casing	finishing	lamping	CRI	lumen	Beam/degree	LED color
LSP120	aluminum	white paint	COB 12W	Ra>90	900lm	15 / 24 / 38 / 60	2700K/3000K /4000K/6000K
							reflector available 

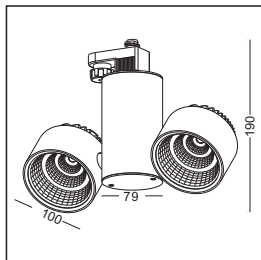

code	casing	finishing	lamping	CRI	lumen	Beam/degree	LED color
LSP121	aluminum	white paint	COB 2x12W	Ra>90	1800lm	15 / 24 / 38 / 60	2700K/3000K /4000K/6000K
							reflector available 









**DESIGN**

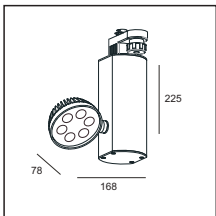

code LSP151-WT  
 casing aluminum  
 finishing white paint  
 lamping LED 12W  
 Lumens 600LM  
 CRI Ra>80  
 Beam 10 / 20 / **30** / 60 degree  
 lamp color 2700K/**3000K**/4000K/6000K  
 Input AC 100-240V  
 installation single circuit/3 line track



IP20

Net Weight 0.95kg

Lens available

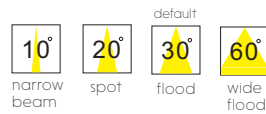

surface customizable

- black paint equal to RAL9011
- concrete grey paint similar to RAL7037

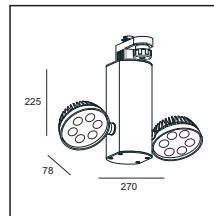

code LSP152-WT  
 casing aluminum  
 finishing white paint  
 lamping LED 2x12W  
 Lumens 1200LM  
 CRI Ra>80  
 Beam 10 / 20 / **30** / 60 degree  
 lamp color 2700K/**3000K**/4000K/6000K  
 Input AC 100-240V  
 installation single circuit/3 line track



IP20

Net Weight 1.3kg

Lens available

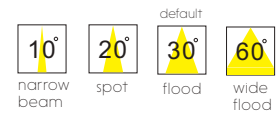

surface customizable

- black paint equal to RAL9011
- concrete grey paint similar to RAL7037

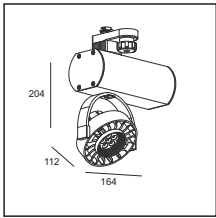

code LSP103  
 casing aluminum  
 finishing white paint  
 lamping LED 6x2W  
 Lumens 600LM  
 CRI Ra>80  
 Beam 15 / **30** / 60 degree  
 lamp color 2700K/**3000K**/4000K/6000K  
 Input AC100-240V  
 installation single circuit/3 line track



Net Weight 0.95kg

lens available

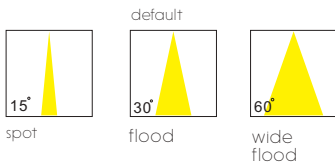

surface customizable

- black paint equal to RAL9011
- concrete grey paint similar to RAL7037

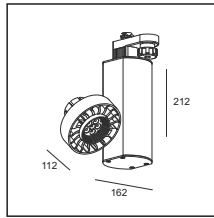

code LSP104  
 casing aluminum  
 finishing white paint  
 lamping LED 6x2W  
 Lumens 600LM  
 CRI Ra>80  
 Beam 15 / **30** / 60 degree  
 lamp color 2700K/**3000K**/4000K/6000K  
 Input AC100-240V  
 installation single circuit/3 line track



Net Weight 0.95kg

lens available

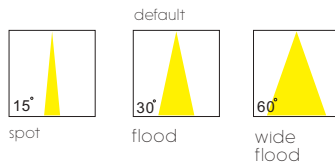

surface customizable

- black paint equal to RAL9011
- concrete grey paint similar to RAL7037

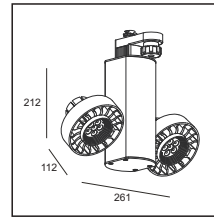

code LSP105  
 casing aluminum  
 finishing white paint  
 lamping LED 2x6x2W  
 Lumens 1200LM  
 CRI Ra>80  
 Beam 15 / **30** / 60 degree  
 lamp color 2700K/**3000K**/4000K/6000K  
 Input AC100-240V  
 installation single circuit/3 line track



Net Weight 1.38kg

lens available

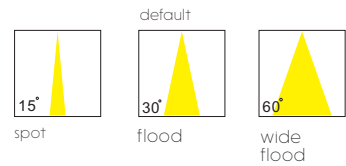

surface customizable

- black paint equal to RAL9011
- concrete grey paint similar to RAL7037







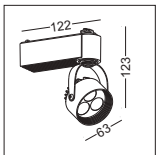

code LSP106  
 casing aluminum  
 finishing white paint  
 lamping LED 3W  
 Lumens 210LM  
 CRI Ra>80  
 Beam 10 / 20 / 30 degree  
 lamp color 2700K/3000K/4000K/6000K  
 Input AC 100-240V  
 installation single circuit/2 line track



Net Weight 0.36kg

lens available

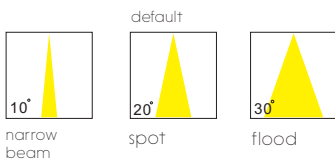

surface customizable

- black paint equal to RAL9011
- concrete grey point similar to RAL7037

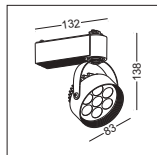

code LSP108  
 casing aluminum  
 finishing white paint  
 lamping LED 7W  
 Lumens 490LM  
 CRI Ra>80  
 Beam 10 / 20 / 30 degree  
 lamp color 2700K/3000K/4000K/6000K  
 Input AC 100-240V  
 installation single circuit/2 line track



Net Weight 0.45kg

lens available

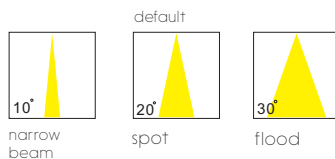

surface customizable

- black paint equal to RAL9011
- concrete grey point similar to RAL7037

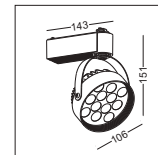

code LSP110  
 casing aluminum  
 finishing white paint  
 lamping LED 12W  
 Lumens 840LM  
 CRI Ra>80  
 Beam 10 / 20 / 30 degree  
 lamp color 2700K/3000K/4000K/6000K  
 Input AC 100-240V  
 installation single circuit/2 line track



Net Weight 0.58kg

lens available

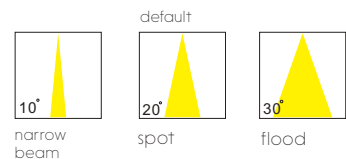

surface customizable

- black paint equal to RAL9011
- concrete grey point similar to RAL7037

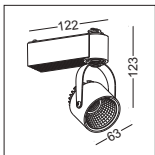

code LSP111  
 casing aluminum  
 finishing white paint  
 lamping COB 5W  
 Lumens 430LM  
 CRI Ra>90  
 Beam 10 / 24 / **38** / 60 degree  
 lamp color 2700K/**3000K**/4000K/6000K  
 Input AC 100-240V  
 installation single circuit/2 line track



▲ Net Weight 0.36kg

reflector available

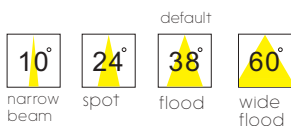

surface customizable

- black paint equal to RAL9011
- concrete grey point similar to RAL7037

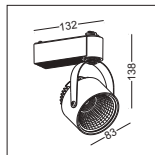

code LSP112  
 casing aluminum  
 finishing white paint  
 lamping COB 9W  
 Lumens 800LM  
 CRI Ra>90  
 Beam 10 / 24 / **38** / 60 degree  
 lamp color 2700K/**3000K**/4000K/6000K  
 Input AC 100-240V  
 installation single circuit/2 line track



▲ Net Weight 0.45kg

reflector available

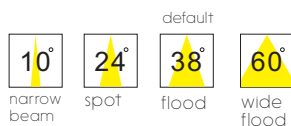

surface customizable

- black paint equal to RAL9011
- concrete grey point similar to RAL7037

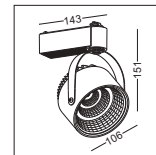

code LSP113  
 casing aluminum  
 finishing white paint  
 lamping COB 12W  
 Lumens 900LM  
 CRI Ra>90  
 Beam 10 / 24 / **38** / 60 degree  
 lamp color 2700K/**3000K**/4000K/6000K  
 Input AC 100-240V  
 installation single circuit/2 line track



▲ Net Weight 0.58kg

reflector available

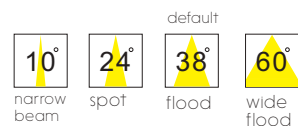

surface customizable

- black paint equal to RAL9011
- concrete grey point similar to RAL7037



# LED TRACK SPOT LIGHT

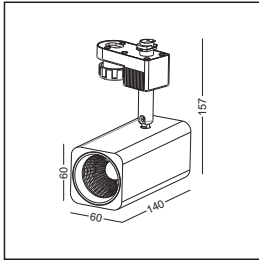

code	casing	finishing	lamping	CRI	lumen	Beam/degree	LED color
LSP166	aluminum	white paint	COB 5W	Ra>90	430lm	10 / 23 / 38	2700K/3000K /4000K/6000K

reflector available:  10° narrow beam,  23° spot,  38° flood

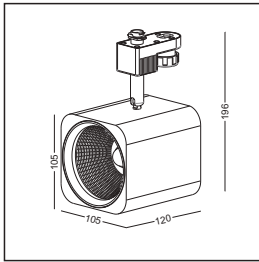

code	casing	finishing	lamping	CRI	lumen	Beam/degree	LED color
LSP167	aluminum	white paint	COB 12W	Ra>90	800lm	10 / 23 / 38	2700K/3000K /4000K/6000K

reflector available:  10° narrow beam,  23° spot,  38° flood

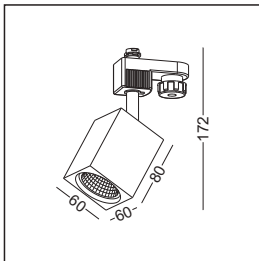

code	casing	finishing	lamping	CRI	lumen	Beam/degree	LED color
LSP134	aluminum	anodized silver	COB 5W	Ra>90	430lm	15 / 24 / 38 / 60	2700K/3000K /4000K/6000K

reflector available:  15° narrow beam,  24° spot,  38° flood,  60° wide flood

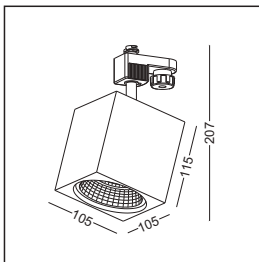

code	casing	finishing	lamping	CRI	lumen	Beam/degree	LED color
LSP135	aluminum	anodized silver	COB 12W	Ra>90	800lm	15 / 24 / 38 / 60	2700K/3000K /4000K/6000K

reflector available:  15° narrow beam,  24° spot,  38° flood,  60° wide flood

surface customizable

- black paint equal to RAL9011
- white paint similar to RAL9003
- concrete grey paint similar to RAL7037

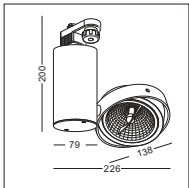

code TR-LSP126-WT  
 casing aluminum  
 finishing white paint  
 lamping halogen Ar 111 35W  
 Beam standard 36 degree  
 installation single circuit/3 line track  
 supplied with reflector  
 and philips halogen bulb  
 bulb can be easily changed  
 from the back of the reflector



▲ Net Weight 1.06kg

reflector available  
 default



flood

surface  
 customizable

- black paint  
equal to RAL9011
- concrete grey paint  
similar to RAL7037

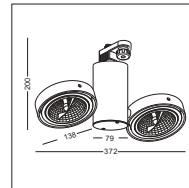

code TR-LSP127-WT  
 casing aluminum  
 finishing white paint  
 lamping halogen Ar 111 2x35W  
 Beam standard 36 degree  
 installation single circuit/3 line track  
 supplied with reflector  
 and philips halogen bulb  
 bulb can be easily changed  
 from the back of the reflector



▲ Net Weight 1.4kg

reflector available  
 default



flood

surface  
 customizable

- black paint  
equal to RAL9011
- concrete grey paint  
similar to RAL7037

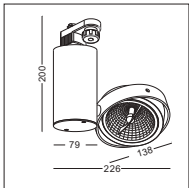

code TR-LSP126-SL  
 casing aluminum  
 finishing anodized silver  
 lamping halogen Ar 111 35W  
 Beam standard 36 degree  
 installation single circuit/3 line track  
 supplied with reflector  
 and philips halogen bulb  
 bulb can be easily changed  
 from the back of the reflector



▲ Net Weight 1.06kg

reflector available  
 default



flood

surface  
 customizable

- black paint  
equal to RAL9011
- concrete grey paint  
similar to RAL7037

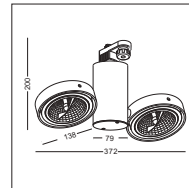

code TR-LSP127-SL  
 casing aluminum  
 finishing anodized silver  
 lamping halogen Ar 111 2x35W  
 Beam standard 36 degree  
 installation single circuit/3 line track  
 supplied with reflector  
 and philips halogen bulb  
 bulb can be easily changed  
 from the back of the reflector



▲ Net Weight 1.4kg

reflector available  
 default



flood

surface  
 customizable

- black paint  
equal to RAL9011
- concrete grey paint  
similar to RAL7037



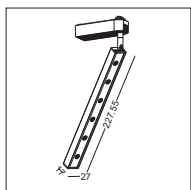

code LSP123  
 casing aluminum  
 finishing anodized black  
 lamping LED 6W  
 Lumens 420LM  
 CRI Ra>80  
 Beam 10 / 20 / 30 degree  
 lamp color 2700K/3000K/4000K/6000K  
 Input AC 100-240V  
 installation single circuit/2 line track



▲ Net Weight 0.3kg

lens available

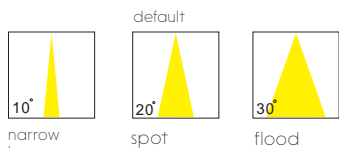

surface customizable

- anodized silver brushed linear
- anodized gold brushed linear
- white paint similar to RAL9003
- concrete grey paint similar to RAL7037

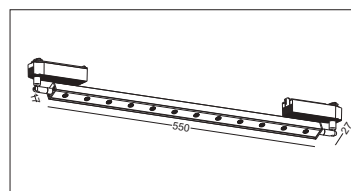

code LSP124  
 casing aluminum  
 finishing anodized black  
 lamping LED 12W  
 Lumens 840LM  
 CRI Ra>80  
 Beam 10 / 20 / 30 degree  
 lamp color 2700K/3000K/4000K/6000K  
 Input AC 100-240V  
 installation single circuit/2 line track



▲ Net Weight 0.6kg

lens available

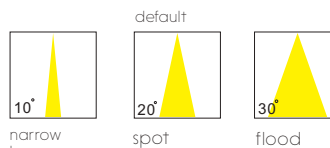

surface customizable

- anodized silver brushed linear
- anodized gold brushed linear
- white paint similar to RAL9003
- concrete grey paint similar to RAL7037

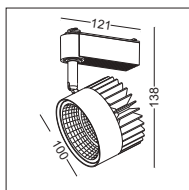
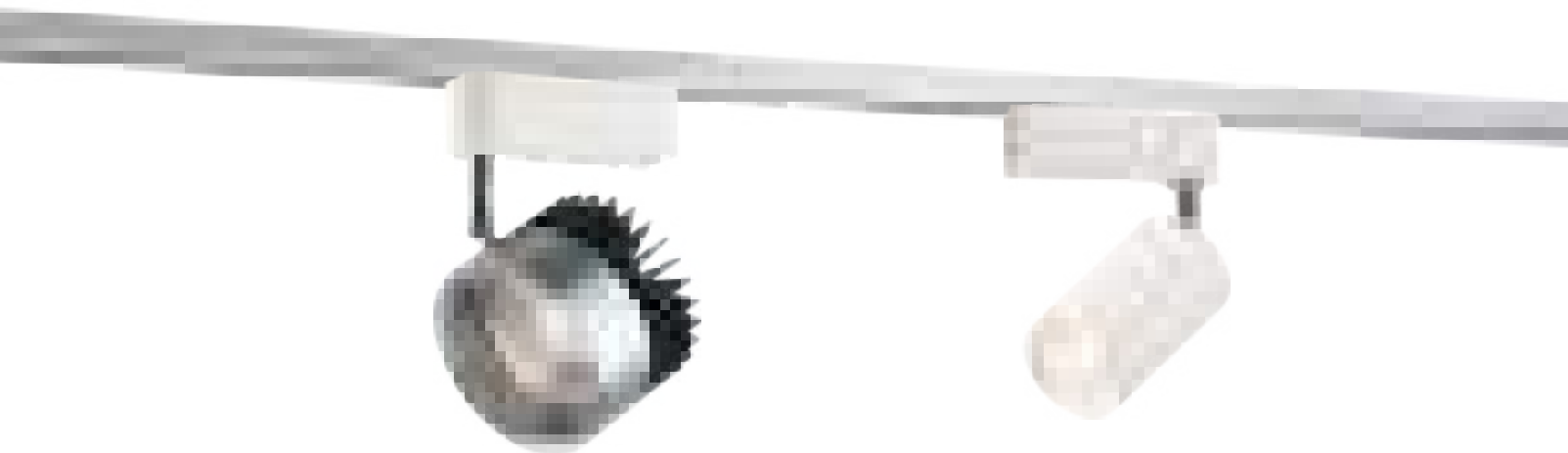

code LSP125  
 casing aluminum  
 finishing anodized silver and black  
 lamping COB 12W  
 Lumens 900LM  
 CRI Ra>90  
 Beam 10 / 24 / 38 / 60 degree  
 lamp color 2700K/3000K/4000K/6000K  
 Input AC 100-240V  
 installation single circuit/2 line track



Net Weight 0.55kg

reflector available

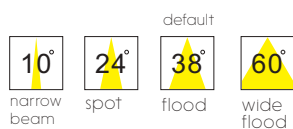

surface customizable

- white paint similar to RAL9003
- black paint equal to RAL9011
- concrete grey paint similar to RAL7037

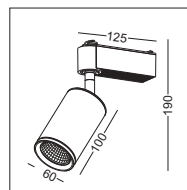

code LSP114  
 casing aluminum  
 finishing white paint  
 lamping COB 5W  
 Lumens 430LM  
 CRI Ra>90  
 Beam 10 / 24 / 38 / 60 degree  
 lamp color 2700K/3000K/4000K/6000K  
 Input AC 100-240V  
 installation single circuit/2 line track



Net Weight 0.39kg

reflector available

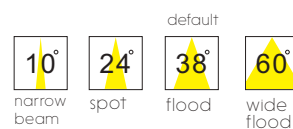

surface customizable

- black paint equal to RAL9011
- concrete grey paint similar to RAL7037

# TRACK ACCESSORIES

## tracks

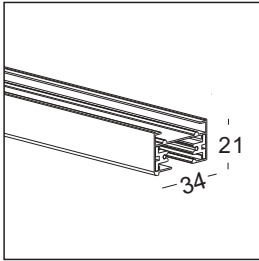

Code	accessory type	length	color	head connector
TRC210WT	2 lines track (without earth connection)	1 Meter	white	included
TRC215WT	2 lines track (without earth connection)	1.5 Meter	white	included
TRC220WT	2 lines track (without earth connection)	2 Meter	white	included
TRC210BK	2 lines track (without earth connection)	1 Meter	black	included
TRC215BK	2 lines track (without earth connection)	1.5 Meter	black	included
TRC220BK	2 lines track (without earth connection)	2 Meter	black	included

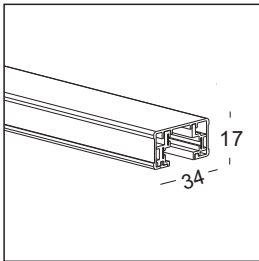

Code	accessory type	length	color	head connector
TRC310WT	3 lines track (with earth connection)	1 Meter	white	included
TRC315WT	3 lines track (with earth connection)	1.5 Meter	white	included
TRC320WT	3 lines track (with earth connection)	2 Meter	white	included
TRC310BK	3 lines track (with earth connection)	1 Meter	black	included
TRC315BK	3 lines track (with earth connection)	1.5 Meter	black	included
TRC320BK	3 lines track (with earth connection)	2 Meter	black	included

# TRACK ACCESSORIES

## track connectors

	Code	accessory type	color
	TRC401WT	2 lines track 180 degree connector	white
	TRC401BK	2 lines track 180 degree connector	black
	TRC402WT	3 lines track 180 degree connector	white
	TRC402BK	3 lines track 180 degree connector	black
	TRC403WT	2 lines track 90 degree connector	white
	TRC403BK	2 lines track 90 degree connector	black
	TRC404WT	3 lines track 90 degree connector	white
	TRC404BK	3 lines track 90 degree connector	black
	TRC405WT	2 lines track four ways connector	white
	TRC405BK	2 lines track four ways connector	black
	TRC406WT	3 lines track four ways connector	white
	TRC406BK	3 lines track four ways connector	black

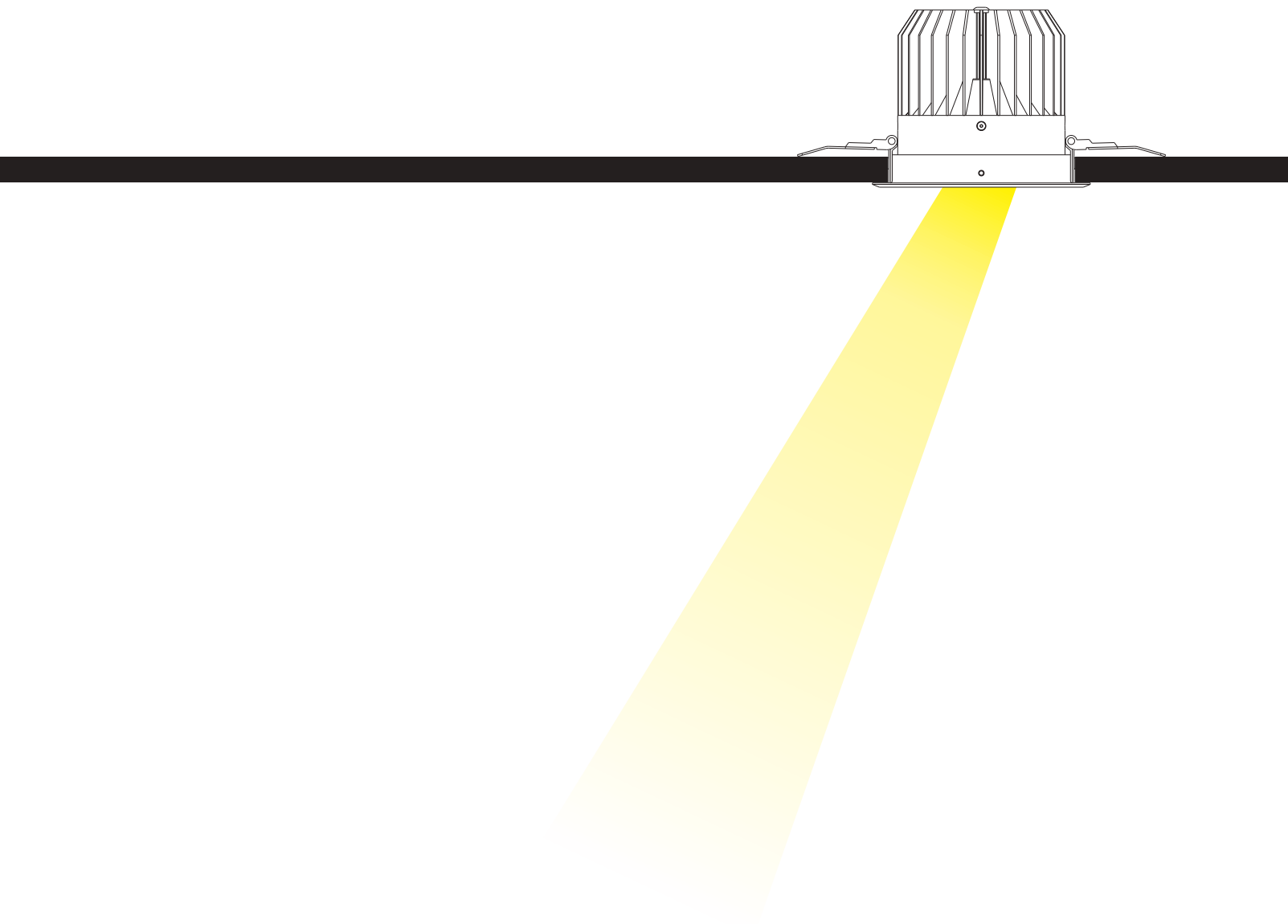

LED  
RECESSED  
SPOT LIGHT



LET'S  
BEGIN  
FROM  
THE  
MINI  
ONES

# LED MINI SPOT LIGHT

## LED DOT LIGHT



The effect of this little tiny thing is twinkling stars on the roof when you install amounts of those lights. The led inside the lamp emits directly down to the ground and with no lense or any optic components, the led chips are shinning with original lights,just like stars in the galaxy. We design this sery beacuse we want a roof like galaxy and the project effect proofs it to be real.

power-supply not included



 IP20
  Dia 30mm installed in groups



code	casing	finishing	lamping	CRI	lumen	Beam	LED color
LDC880-BK	aluminum	brushed black	LED 1W	Ra>80	70lm	No lense	2700K/3000K/4000K/6000K/ red /green/blue



code	casing	finishing	lamping	CRI	lumen	Beam	LED color
LDC880-WT	aluminum	white coated	LED 1W	Ra>80	70lm	No lense	2700K/3000K/4000K/6000K/ red /green/blue



code	casing	finishing	lamping	CRI	lumen	Beam	LED color
LDC880-SL	aluminum	brushed silver	LED 1W	Ra>80	70lm	No lense	2700K/3000K/4000K/6000K/ red /green/blue



code	casing	finishing	lamping	CRI	lumen	Beam	LED color
LDC880-CR	aluminum	chrome plated	LED 1W	Ra>80	70lm	No lense	2700K/3000K/4000K/6000K/ red /green/blue



code	casing	finishing	lamping	CRI	lumen	Beam	LED color
LDC880-GD	aluminum	gold plated	LED 1W	Ra>80	70lm	No lense	2700K/3000K/4000K/6000K/ red /green/blue



code	casing	finishing	lamping	CRI	lumen	Beam	LED color
LDC880-RG	aluminum	rose gold plated	LED 1W	Ra>80	70lm	No lense	2700K/3000K/4000K/6000K/ red /green/blue







## LED MINI SPOT LIGHT

### LED DOT LIGHT



LDC880A series is a updated version for LDC880 series. Adding lens to the led chips, to prevent dazzle light directly from the led chips. Though its' light doesn't look light a shining star, it have got more soft light and give more light on the ground or objects on the ground. Installing those little fixtures by groups every other 30cm in the whole roof instead of installing a bigger recessed spot light every other 2 meter, it appears more fancy and attractive.

This series have got 4 default colors available and they almost match most of the ceiling color, no matter you want a harmony design or a conflict design. Except installed on the roof, it is also very good for bathroom. Just imaging lots of little light on the bathroom ceiling, far more fancy than a boring 5W spot light. And one more applicant is cabinet lighting. You can install this series in the shop cabinets , like cloth shop, wine shop and so on. It can be easily installed due to its little size and gives just enough light, no more and no less

# LED MINI SPOT LIGHT

lens available

LED DOT LIGHT  
1W SERIES

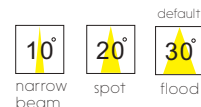

LDC880A-WT



LDC880A-SL



LDC880A-GD



LDC880A-BK

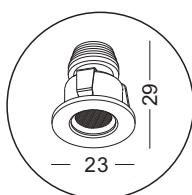

Ø Dia 20mm  
installed in groups  
power-supply  
not included

■ ◊ CE F IP20

code	casing	finishing	lamping	CRI	lumen	Beam/degree	LED color
LDC880A-WT	aluminum	brushed black	LED 1W	Ra>80	70lm	10 / 20 / 30	2700K/ <del>3000K</del> /4000K/6000K /red/green/blue
LDC880A-SL	aluminum	brushed silver	LED 1W	Ra>80	70lm	10 / 20 / 30	2700K/ <del>3000K</del> /4000K/6000K /red/green/blue
LDC880A-GD	aluminum	gold plated	LED 1W	Ra>80	70lm	10 / 20 / 30	2700K/ <del>3000K</del> /4000K/6000K /red/green/blue
LDC880A-BK	aluminum	brushed black	LED 1W	Ra>80	70lm	10 / 20 / 30	2700K/ <del>3000K</del> /4000K/6000K /red/green/blue

# LED MINI SPOT LIGHT

lens available

LED DOT LIGHT  
3W SERIES

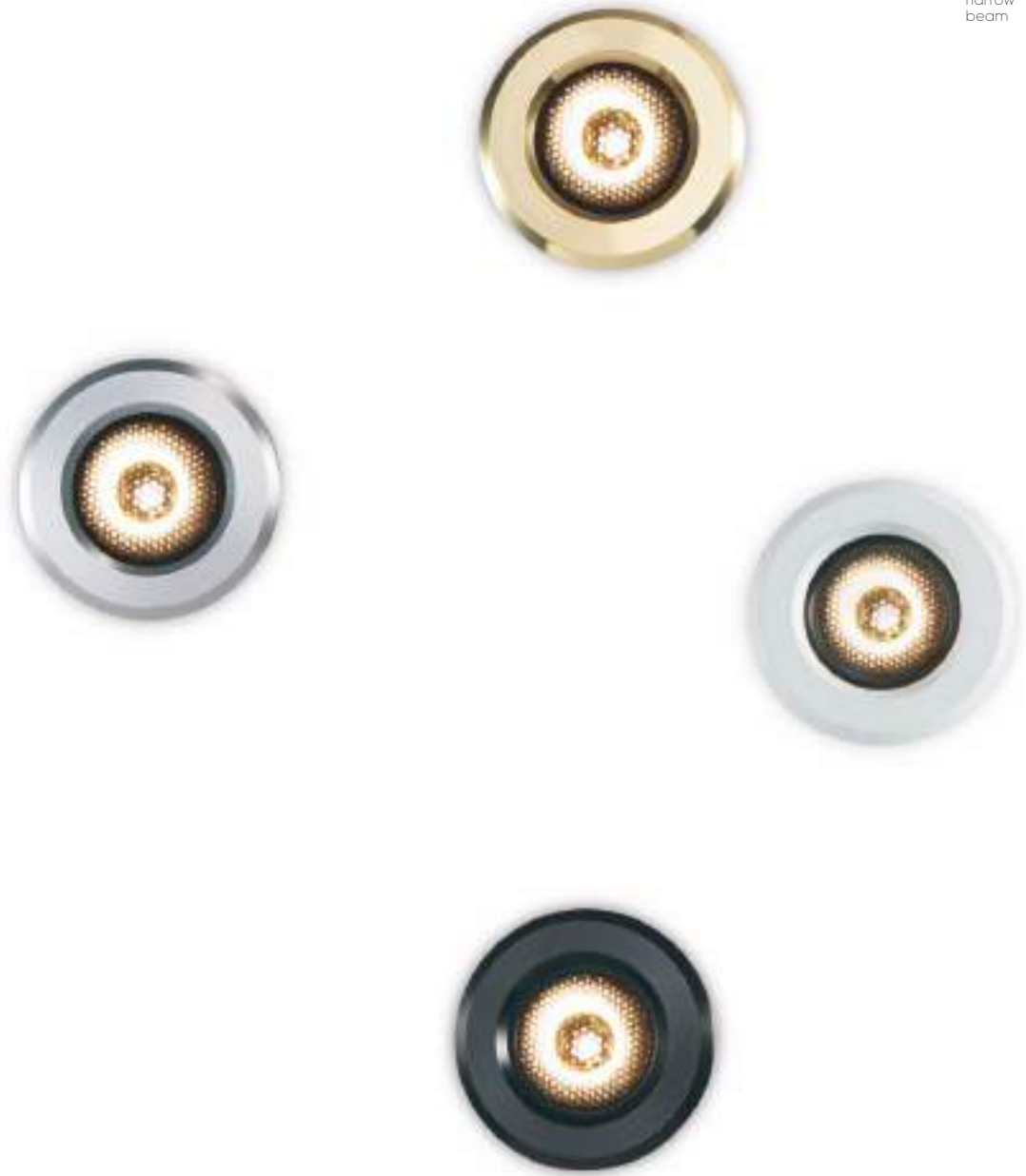
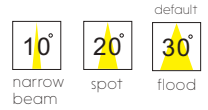

surface customizable

-  chrome plated
-  concrete grey paint similar to RAL7037

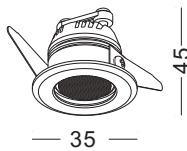

  IP20

 Dia 30mm

installed in groups

power-supply not included

code	casing	finishing	lamping	CRI	lumen	Beam/degree	LED color
LDC005A-WT	aluminum	white painting	LED 3W	Ra>80	120lm	10 / 20 / 30	2700K/3000K /4000K/6000K /red/green/blue
LDC005A-BK	aluminum	anodized black	LED 3W	Ra>80	120lm	10 / 20 / 30	2700K/3000K /4000K/6000K /red/green/blue
LDC005A-SL	aluminum	anodized silver	LED 3W	Ra>80	120lm	10 / 20 / 30	2700K/3000K /4000K/6000K /red/green/blue
LDC005A-GD	aluminum	gold plated	LED 3W	Ra>80	120lm	10 / 20 / 30	2700K/3000K /4000K/6000K /red/green/blue

# LED MINI SPOT LIGHT

lens available

LED DOT LIGHT  
3W SERIES  
ROTATABLE

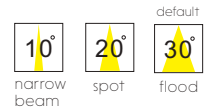

surface customizable

-  chrome plated
-  concrete grey paint similar to RAL7037

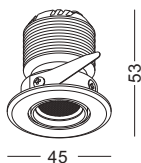

  IP20

 Dia 40mm

installed in groups/single  
power-supply for single  
installation is included

code	casing	finishing	lamping	CRI	lumen	Beam/degree	LED color
LDC001A-WT	aluminum	white painting	LED 3W	Ra>80	120lm	10 / 20 / 30	2700K/3000K /4000K/6000K /red/green/blue
LDC001A-BK	aluminum	anodized black	LED 3W	Ra>80	120lm	10 / 20 / 30	2700K/3000K /4000K/6000K /red/green/blue
LDC001A-SL	aluminum	anodized silver	LED 3W	Ra>80	120lm	10 / 20 / 30	2700K/3000K /4000K/6000K /red/green/blue
LDC001A-GD	aluminum	gold plated	LED 3W	Ra>80	120lm	10 / 20 / 30	2700K/3000K /4000K/6000K /red/green/blue

# LED MINI SPOT LIGHT

## GUIDE FOR INSTALLATION IN SERIES LDC880/LDC880A/LDC005A/LDC001A

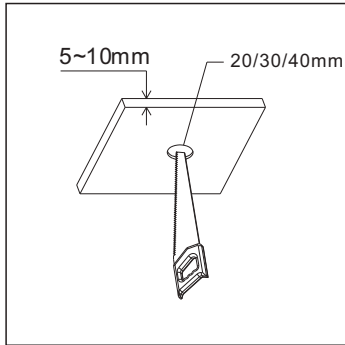

Drill holes on the ceiling  
20mm for LDC880/LDC880A  
30mm for LDC005A  
40mm for LDC001A

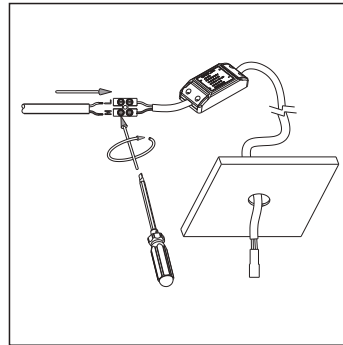

Installed power-supply on the ceiling power-supply will be supplied separately by manufacturer. Consult with seller's engineer for the specification of power-supply you need. 6-12pcs for one group is strongly recommended.

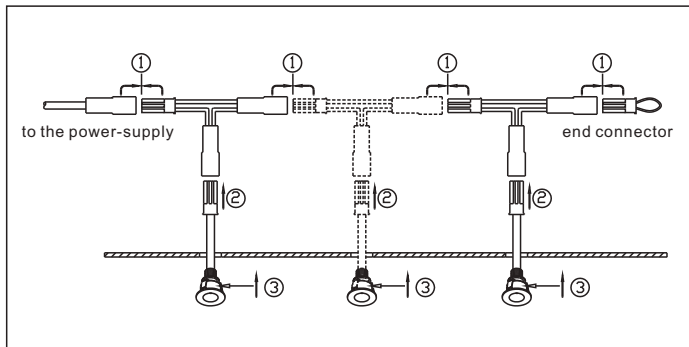

Connect the lamp each by each, using the junction cable supplied with the lamp and put the end connector to the last lamp. Connect the first lamp to the power-supply. The default MAXIMUM distance between two lamps is 50cm. If you would like to make it more than 50cm, the junction cables must be longer.

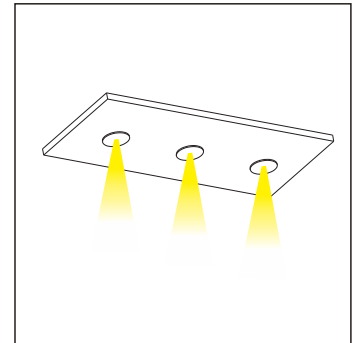





# LED SPOT LIGHT

surface customizable     anodized silver brushed linear     concrete grey paint similar to RAL7037     chrome plated

DEEP RECESSED  
MINI COB SPOTLIGHT  
6W UP TO 500LM CRI90  
DIA 56MM CUT DIA 50MM  
FOUR COLORS OPTIONAL  
THREE COLORS CUSTOMIZABLE

---



LDC992-BK



LDC992-WT



LDC992-GD



LDC992-SL

DEEP RECESSED  
MINI COB SPOTLIGHT  
6W UP TO 500LM CRI85  
ROTATABLE FOUR COLORS  
THREE COLORS CUSTOMIZABLE

---



LDC993-BK



LDC993-WT



LDC993-GD



LDC993-SL

# LED SPOT LIGHT

## Datasheet

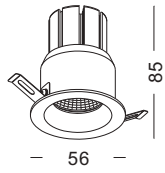

code	casing	finishing	lamping	CRI	lumen	LED color	reflector available
LDC992-BK	aluminum	black paint	COB 6W	Ra>90	500lm	2700K/3000K /4000K/6000K	 
LDC992-WT	aluminum	white paint	COB 6W	Ra>90	500lm	2700K/3000K /4000K/6000K	
LDC992-GD	aluminum	anodized gold	COB 6W	Ra>90	500lm	2700K/3000K /4000K/6000K	
LDC992-SL	aluminum	anodized silver	COB 6W	Ra>90	500lm	2700K/3000K /4000K/6000K	

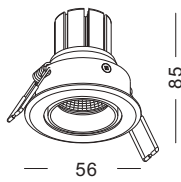

code	casing	finishing	lamping	CRI	lumen	LED color	reflector available
LDC992-BK	aluminum	black paint	COB 6W	Ra>90	500lm	2700K/3000K /4000K/6000K	 
LDC992-WT	aluminum	white paint	COB 6W	Ra>90	500lm	2700K/3000K /4000K/6000K	
LDC992-GD	aluminum	anodized gold	COB 6W	Ra>90	500lm	2700K/3000K /4000K/6000K	
LDC992-SL	aluminum	anodized silver	COB 6W	Ra>90	500lm	2700K/3000K /4000K/6000K	



The frosted glass makes the light soft and even and over 90% efficiency after glass

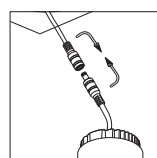

plug and lock connector between led and power-supply

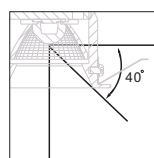



up to 40 degree shielding angle







# LED SPOT LIGHT

reflector available

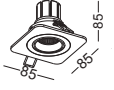
surface customizable  black paint equal to RAL9011  concrete grey paint similar to RAL7037  anodized gold brushed circular

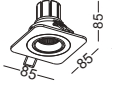
13° narrow beam  default 23° spot 



		code	casing	finishing	lamping	CRI	lumen	Beam/degree	LED color
 Dia 65mm	IP20	LDC994-SL	aluminum	brushed silver	COB 6W	Ra>90	500lm	13 / 23	2700K/3000K /4000K/6000K
 65x145 mm	IP20	LDC995-SL	aluminum	brushed silver	COB 2x6W	Ra>90	1000lm	13 / 23	2700K/3000K /4000K/6000K
 65x220 mm	IP20	LDC996-SL	aluminum	brushed silver	COB 3x6W	Ra>90	1500lm	13 / 23	2700K/3000K /4000K/6000K
 145x145 mm	IP20	LDC997-SL	aluminum	brushed silver	COB 4x6W	Ra>90	2000lm	13 / 23	2700K/3000K /4000K/6000K



The frosted glass makes the light soft and even and over 90% efficiency after glass

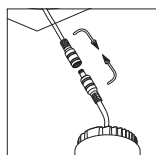

plug and lock connector between led and power-supply

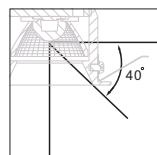





up to 40 degree shielding angle

# LED SPOT LIGHT

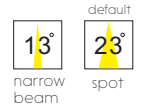
reflector available

surface customizable  black paint equal to RAL9011  concrete grey paint similar to RAL7037  anodized gold brushed circular

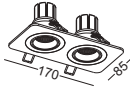
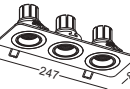
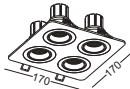

		code	casing	finishing	lamping	CRI	lumen	Beam/degree	LED color
 Dia 65mm	IP20	LDC994-WT	aluminum	white paint	COB 6W	Ra>90	500lm	13 / 23	2700K/3000K /4000K/6000K
 65x145 mm	IP20	LDC995-WT	aluminum	white paint	COB 2x6W	Ra>90	1000lm	13 / 23	2700K/3000K /4000K/6000K
 65x220 mm	IP20	LDC996-WT	aluminum	white paint	COB 3x6W	Ra>90	1500lm	13 / 23	2700K/3000K /4000K/6000K
 145x145 mm	IP20	LDC997-WT	aluminum	white paint	COB 4x6W	Ra>90	2000lm	13 / 23	2700K/3000K /4000K/6000K



The frosted glass makes the light soft and even and over 90% efficiency after glass

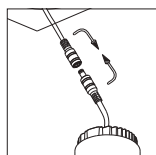

plug and lock connector between led and power-supply

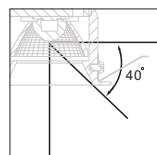

up to 40 degree shielding angle

# LED SPOT LIGHT

surface customizable ■ black paint equal to RAL9011 ■ concrete grey paint similar to RAL7037 ■ anodized gold brushed circular



LDC926-WT



LDC927-WT



LDC928-WT



LDC928-SL



LDC927-SL



LDC926-SL

# LED SPOT LIGHT







## Datasheet

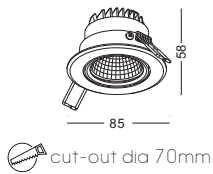









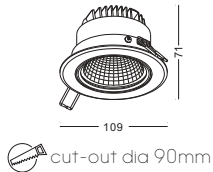

 IP20







code	casing	finishing	lamping	CRI	lumen	LED color	reflector available
LDC926-WT	aluminum	white paint	COB 5W	Ra>90	430lm	2700K/3000K /4000K/6000K	   
LDC926-SL	aluminum	anodized silver	COB 5W	Ra>90	430lm	2700K/3000K /4000K/6000K	   

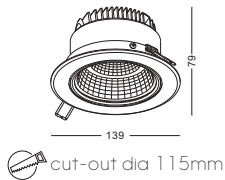

code	casing	finishing	lamping	CRI	lumen	LED color	reflector available
LDC927-WT	aluminum	white paint	COB 9W	Ra>90	800lm	2700K/3000K /4000K/6000K	   
LDC927-SL	aluminum	anodized silver	COB 9W	Ra>90	800lm	2700K/3000K /4000K/6000K	   



code	casing	finishing	lamping	CRI	lumen	LED color	reflector available
LDC928-WT	aluminum	white paint	COB 12W	Ra>90	900lm	2700K/3000K /4000K/6000K	   
LDC928-SL	aluminum	anodized silver	COB 12W	Ra>90	900lm	2700K/3000K /4000K/6000K	   



# LED SPOT LIGHT

surface  
customizable



black paint  
equal to RAL9011



concrete grey paint  
similar to RAL7037



anodized gold  
brushed circular



LDC926A-SL



LDC928A-WT



LDC927A-SL



LDC927A-WT



LDC928A-SL



LDC926A-WT











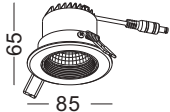















# LED SPOT LIGHT

## Datasheet





 IP20

	code	casing	finishing	lamping	CRI	lumen	LED color	reflector available
	LDC926A-WT	aluminum	white paint	COB 5W	Ra>90	430lm	2700K/3000K /4000K/6000K	   
	LDC926A-SL	aluminum	anodized silver	COB 5W	Ra>90	430lm	2700K/3000K /4000K/6000K	 narrow beam  spot  flood  wide flood
cut-out dia 70mm								
	LDC927A-WT	aluminum	white paint	COB 9W	Ra>90	800lm	2700K/3000K /4000K/6000K	   
	LDC927A-SL	aluminum	anodized silver	COB 9W	Ra>90	800lm	2700K/3000K /4000K/6000K	 narrow beam  spot  flood  wide flood
cut-out dia 90mm								
	LDC928A-WT	aluminum	white paint	COB 12W	Ra>90	900lm	2700K/3000K /4000K/6000K	   
	LDC928A-SL	aluminum	anodized silver	COB 12W	Ra>90	900lm	2700K/3000K /4000K/6000K	 narrow beam  spot  flood  wide flood
cut-out dia 115mm								





# LED SPOT LIGHT

surface  
customizable



black paint  
equal to RAL9011



concrete grey paint  
similar to RAL7037



anodized gold  
brushed circular



chrome plated



LDC978B



LDC979B



LDC978A



LDC979A

# LED SPOT LIGHT

reflector available

## Datasheet

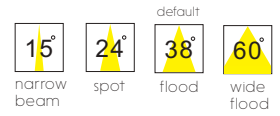

		code	casing	finishing	lamping	CRI	lumen	Beam/degree	LED color
<p>Dia 70mm</p>	<p>IP20</p>	LDC978B	aluminum	brushed silver	COB 5W	Ra>90	430lm	15 / 24 / 38 / 60	2700K/3000K /4000K/6000K
<p>Dia 70mm</p>	<p>IP20</p>	LDC979B	aluminum	brushed silver	COB 5W	Ra>90	430lm	15 / 24 / 38 / 60	2700K/3000K /4000K/6000K
<p>Dia 70mm</p>	<p>IP20</p>	LDC978A	acrylic cover aluminum heat sink	brushed silver	COB 5W	Ra>90	430lm	15 / 24 / 38 / 60	2700K/3000K /4000K/6000K
<p>Dia 70mm</p>	<p>IP20</p>	LDC979A	acrylic cover aluminum heat sink	brushed silver	COB 5W	Ra>90	430lm	15 / 24 / 38 / 60	2700K/3000K /4000K/6000K





# LED SPOT LIGHT

reflector available

surface customizable  black paint equal to RAL9011  concrete grey paint similar to RAL7037  anodized gold brushed circular  chrome plated

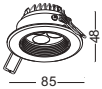

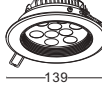
		code	casing	finishing	lamping	CRI	lumen	Beam/degree	LED color
85 Dia 70mm	IP20	LDC935A	aluminum	white paint	LED 3W	Ra>80	300lm	30 degree	2700K/ <del>3000K</del> /4000K/6000K
	IP20	LDC936A	aluminum	white paint	LED 5W	Ra>80	600lm	30 degree	2700K/ <del>3000K</del> /4000K/6000K
109 Dia 90mm	IP20	LDC938A	aluminum	white paint	LED 9W	Ra>80	900lm	30 degree	2700K/ <del>3000K</del> /4000K/6000K
	IP20								
139 Dia 115mm	IP20								







# LED SPOT LIGHT

reflector available

surface customizable  white paint similar to RAL9003  concrete grey paint similar to RAL7037  anodized gold brushed circular  chrome plated



 Dia 55x170mm		code	casing	finishing	lamping	CRI	lumen	Beam/degree	LED color
	IP20	LDC984	aluminum	anodized black	Cree XML 8W	Ra>80	800lm	30 degree	2700K/3000K/4000K/6000K
 Dia 22x170mm		code	casing	finishing	lamping	CRI	lumen	Beam/degree	LED color
	IP20	LDC985	aluminum	anodized black	Cree XML 8W	Ra>80	800lm	30 degree	2700K/3000K/4000K/6000K

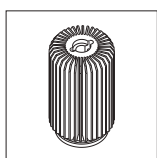

The long heat sink need a minimum 170mm installation space up the ceiling

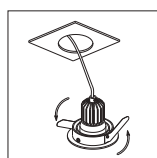

LDC984 installed from in the front of the ceiling

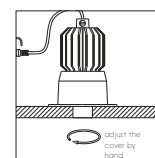
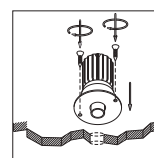
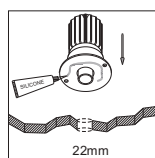

LDC985 installed from the back of the ceiling

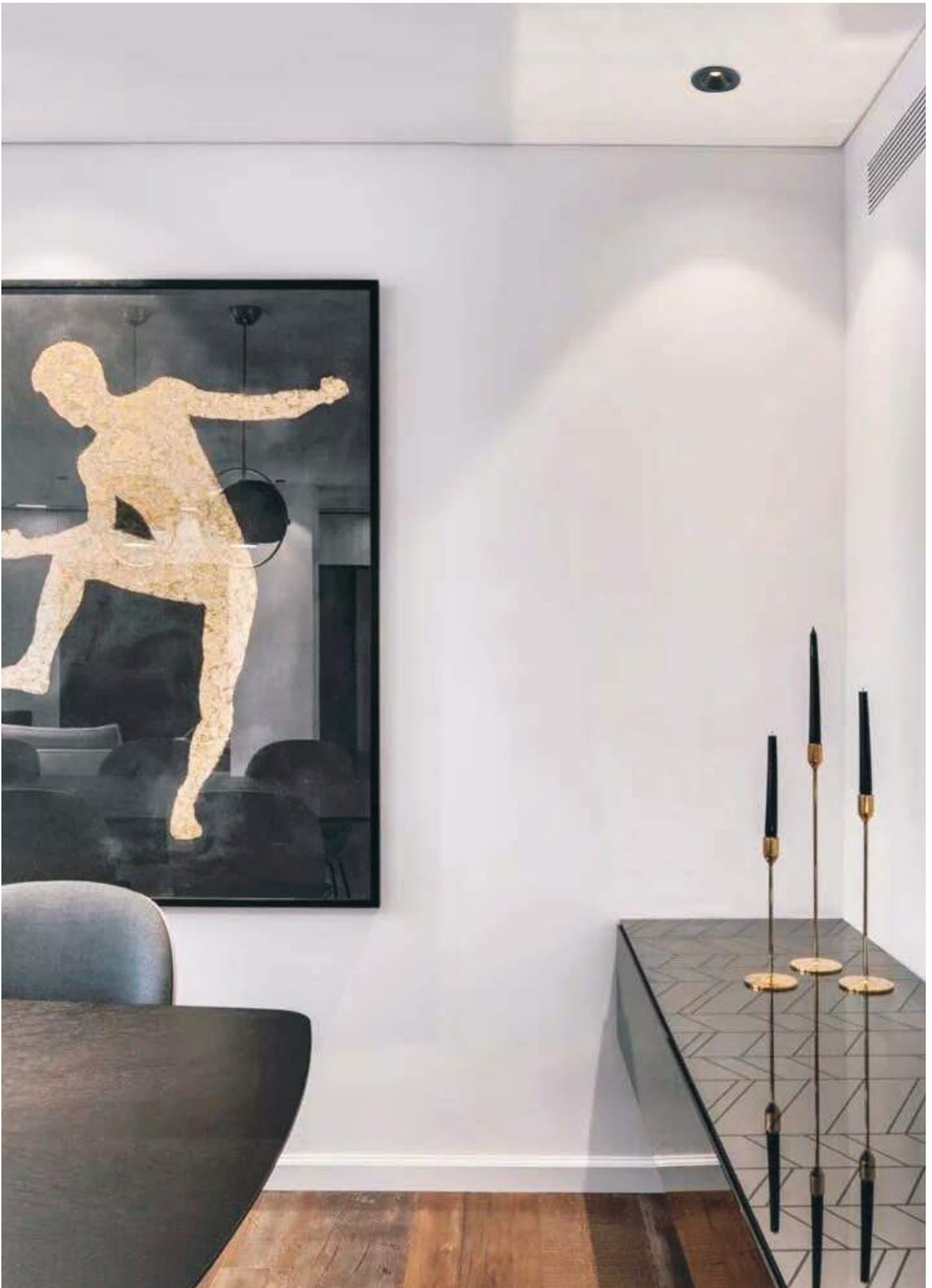





With the design principle of being as simple as possible, we design this series of recessed spot light. Although it cost a lot of aluminum material to make the lamp casing from a solid aluminum trunk, the front cover looks so entirety and elegant. It has got perfect shape by seeing in front, one piece, same color, perfect straight curve, big shielding angle. By using CREE CXA series Cob chips, the CRI of this series can reach up to RA90, and very high lumen output efficiency, up to 80lm per watt. The installation is also easy with easy connector between lamp and the power-supply.

This series have got three default color, white, gold, and black. Also it has got three sizes, from 5W to 20W, output will be from 430lm to 1800lm. The light angle can be 15/24/38/60 degree, from narrow beam to wide flood. It can fulfill most requirements of home lighting and architecture lighting. The lamp body can be custom made to other colors if customer want something new in the ceiling. As we know, pure aluminum is very nice material, it can be anodized or plated or power-coating, so this series will give customer choices as much as possible.



# LED SPOT LIGHT DEEP RECESSED

## COB 5W SERIES



code	casing	finishing	lamping	CRI	lumen	LED color
LDC988-WT	aluminum	white paint	COB 5W	Ra>90	430lm	2700K/3000K /4000K/6000K



code	casing	finishing	lamping	CRI	lumen	LED color
LDC988-BK	aluminum	black paint	COB 5W	Ra>90	430lm	2700K/3000K /4000K/6000K



code	casing	finishing	lamping	CRI	lumen	LED color
LDC988-GD	aluminum	anodized gold	COB 5W	Ra>90	430lm	2700K/3000K /4000K/6000K

reflector available

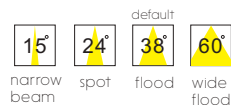

cut-out dia 72mm

surface customizable

concrete grey paint similar to RAL7037

## COB 9W SERIES



code	casing	finishing	lamping	CRI	lumen	LED color
LDC989-WT	aluminum	white paint	COB 9W	Ra>90	800lm	2700K/3000K /4000K/6000K



code	casing	finishing	lamping	CRI	lumen	LED color
LDC989-BK	aluminum	black paint	COB 9W	Ra>90	800lm	2700K/3000K /4000K/6000K



code	casing	finishing	lamping	CRI	lumen	LED color
LDC989-GD	aluminum	anodized gold	COB 9W	Ra>90	800lm	2700K/3000K /4000K/6000K

reflector available

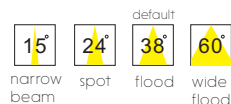

cut-out dia 97mm

surface customizable

concrete grey paint similar to RAL7037

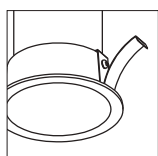

stainless steel installation spring

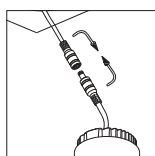

plug and lock connector between led and power-supply

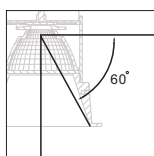

LDC988 up to 60 degree shielding angle

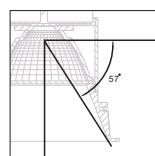

LDC989 up to 57 degree shielding angle

# LED SPOT LIGHT DEEP RECESSED

## COB 12W SERIES



code	casing	finishing	lamping	CRI	lumen	LED color
LDC990-WT	aluminum	white paint	COB 12W	Ra>90	900lm	2700K/3000K /4000K/6000K



code	casing	finishing	lamping	CRI	lumen	LED color
LDC990-BK	aluminum	black paint	COB 12W	Ra>90	900lm	2700K/3000K /4000K/6000K



code	casing	finishing	lamping	CRI	lumen	LED color
LDC990-GD	aluminum	anodized gold	COB 12W	Ra>90	900lm	2700K/3000K /4000K/6000K

reflector available

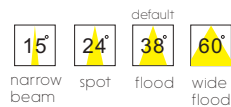

cut-out dia 122mm

surface customizable

concrete grey paint similar to RAL7037

## COB 20W SERIES



code	casing	finishing	lamping	CRI	lumen	LED color
LDC991-WT	aluminum	white paint	COB 20W	Ra>90	1700lm	2700K/3000K /4000K/6000K



code	casing	finishing	lamping	CRI	lumen	LED color
LDC991-BK	aluminum	black paint	COB 20W	Ra>90	1700lm	2700K/3000K /4000K/6000K



code	casing	finishing	lamping	CRI	lumen	LED color
LDC991-GD	aluminum	anodized gold	COB 20W	Ra>90	1700lm	2700K/3000K /4000K/6000K

reflector available

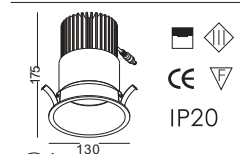
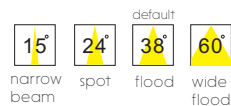

cut-out dia 122mm

surface customizable

concrete grey paint similar to RAL7037

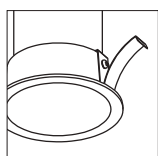

stainless steel installation spring

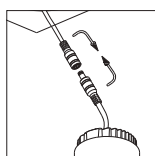

plug and lock connector between led and power-supply

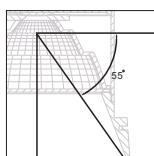

LDC990 up to 55 degree shielding angle

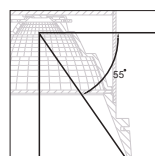

LDC991 up to 55 degree shielding angle

# LED SPOT LIGHT HIGH POWER HIGH LUMENS

---



# LED SPOT LIGHT HIGH POWER HIGH LUMENS

reflector available

surface customizable

black paint equal to RAL9011

concrete grey paint similar to RAL7037

default

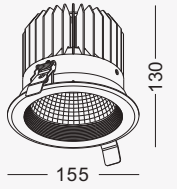
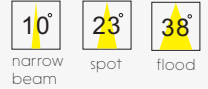

code	casing	finishing	lamping	CRI	lumen	Beam/degree	LED color
LDC207-20W	aluminum	white painting	CREE COB 18 16 20W	Ra>90	1600lm	10/23/38	2700K/3000K /4000K/6000K
LDC207-24W	aluminum	white painting	CREE COB 18 16 24W	Ra>90	1920lm	10/23/38	2700K/3000K /4000K/6000K
LDC207-28W	aluminum	white painting	CREE COB 18 20 28W	Ra>90	2240lm	10/23/38	2700K/3000K /4000K/6000K

cut-out dia 140mm  
IP20

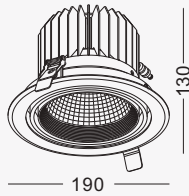

code	casing	finishing	lamping	CRI	lumen	Beam/degree	LED color
LDC208-20W	aluminum	white painting	CREE COB 18 16 20W	Ra>90	1600lm	10/23/38	2700K/3000K /4000K/6000K
LDC208-24W	aluminum	white painting	CREE COB 18 16 24W	Ra>90	1920lm	10/23/38	2700K/3000K /4000K/6000K
LDC208-28W	aluminum	white painting	CREE COB 18 20 28W	Ra>90	2240lm	10/23/38	2700K/3000K /4000K/6000K

cut-out dia 170mm  
IP20

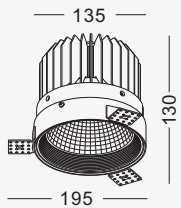

code	casing	finishing	lamping	CRI	lumen	Beam/degree	LED color
LDC209-20W	aluminum	white painting	CREE COB 18 16 20W	Ra>90	1600lm	10/23/38	2700K/3000K /4000K/6000K
LDC209-24W	aluminum	white painting	CREE COB 18 16 24W	Ra>90	1920lm	10/23/38	2700K/3000K /4000K/6000K
LDC209-28W	aluminum	white painting	CREE COB 18 20 28W	Ra>90	2240lm	10/23/38	2700K/3000K /4000K/6000K

cut-out dia 140 mm  
IP20

LDC209 four steps installation

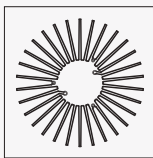
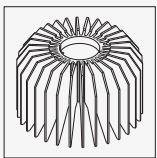
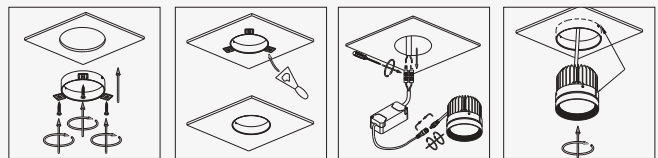

strong and solid heat sink makes good heat management

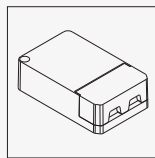

philips power-supply for the whole series



strong metal spring clips

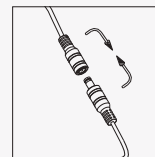

locking connectors make easy and stable connection between lamp and power-supply



Related products LDC211 series in chapter LED grille light

# LED SPOT LIGHT RIMLESS

reflector available

surface customizable



black paint equal to RAL9011



concrete grey paint similar to RAL7037

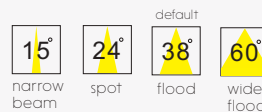

RIMLESS  
DEEP RECESSED  
SPOTLIGHT UP TO 12W  
EASY INSTALLATION

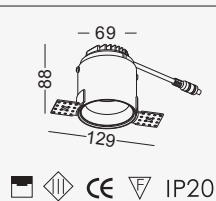

code LDC339  
casing aluminum / white painting  
lamping cob 5W / Ra>90 / 430LM  
Beam 15 / 24 / 38 / 60 degree  
2700K/3000K/4000K/6000K  
installation cut-out dia 74mm

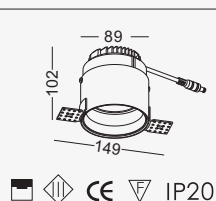

code LDC340  
casing aluminum / white painting  
lamping cob 9W / Ra>90 / 800LM  
Beam 15 / 24 / 38 / 60 degree  
2700K/3000K/4000K/6000K  
installation cut-out dia 94mm

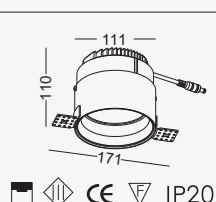

code LDC341  
casing aluminum / white painting  
lamping cob 12W / Ra>90 / 900LM  
Beam 15 / 24 / 38 / 60 degree  
2700K/3000K/4000K/6000K  
installation cut-out dia 116mm

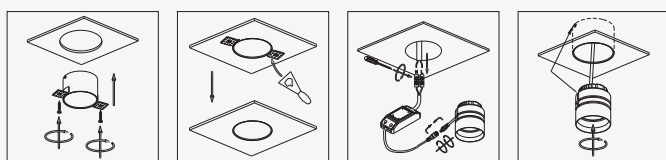

Installation Guide

reflector available

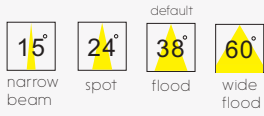

# LED SPOT LIGHT RIMLESS

surface customizable  black paint equal to RAL9011  concrete grey paint similar to RAL7037

RIMLESS  
DEEP RECESSED  
ROTATABLE  
SPOTLIGHT UP TO 12W  
EASY INSTALLATION

code LDC342  
casing aluminum / white painting  
lamping cob 5W / Ra>90 / 430LM  
Beam 15 / 24 / 38 / 60 degree  
2700K/3000K/4000K/6000K  
installation  cut-out dia 74mm



code LDC343  
casing aluminum / white painting  
lamping cob 9W / Ra>90 / 800LM  
Beam 15 / 24 / 38 / 60 degree  
2700K/3000K/4000K/6000K  
installation  cut-out dia 94mm



code LDC344  
casing aluminum / white painting  
lamping cob 12W / Ra>90 / 900LM  
Beam 15 / 24 / 38 / 60 degree  
2700K/3000K/4000K/6000K  
installation  cut-out dia 116mm



## Installation Guide

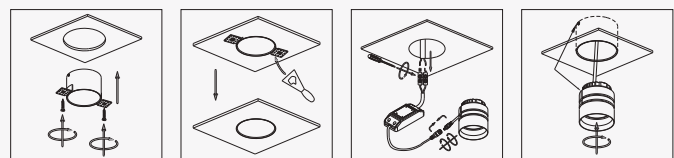

# LED SPOT LIGHT FREE ROTATE



code LDC970  
 casing aluminum / white painting  
 lamping cob 12W / Ra>90 / 900LM  
 Beam 15 / 24 / **38** / 60 degree  
 2700K/**3000K**/4000K/6000K  
 installation cut-out dia 150mm

code LDC969  
 casing aluminum / white painting  
 lamping cob 5W / Ra>90 / 430LM  
 Beam 15 / 24 / **38** / 60 degree  
 2700K/**3000K**/4000K/6000K  
 installation cut-out dia 115mm

surface customizable

- black paint equal to RAL9011
- concrete grey paint similar to RAL7037

reflector available

- 15° narrow beam
- 24° spot
- 38° default flood
- 60° wide flood

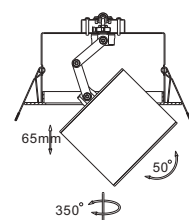
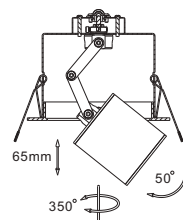

# LED SPOT LIGHT FREE ROTATE

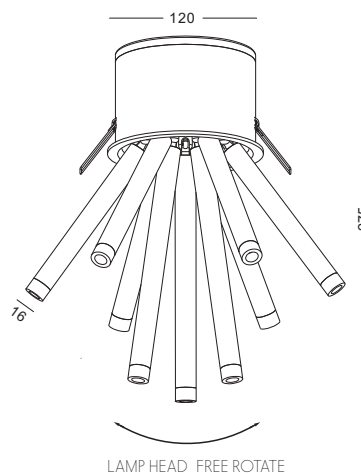

code LDC987-WT / LDC987-BK

surface customizable

■ concrete grey paint similar to RAL7037

■ anodized gold brushed circular

casing aluminum / white/black painting / lamping LED 9x1W / Ra>80 / 630LM / Beam 10/20/30 degree / 2700K/3000K/4000K/6000K

installation   IP20

lamp head dia 16mm with acrylic decoration in front of the lense





# LED SPOT LIGHT

reflector available

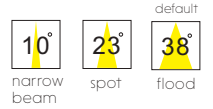
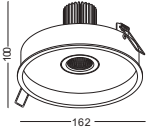
surface customizable  black paint equal to RAL9011  concrete grey paint similar to RAL7037



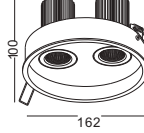

code LDC382  
 casing aluminum / white painting  
 lamping cob 6W / Ra>90 / 500LM  
 Beam 10 / 23 / **38** degree  
 2700K/**3000K**/4000K/6000K  
 installation  cut-out dia 155 mm

  IP20



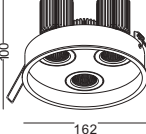

code LDC383  
 casing aluminum / white painting  
 lamping cob 2x6W / Ra>90 / 1000LM  
 Beam 10 / 23 / **38** degree  
 2700K/**3000K**/4000K/6000K  
 installation  cut-out dia 155 mm

  IP20





code LDC384  
 casing aluminum / white painting  
 lamping cob 3x6W / Ra>90 / 1500LM  
 Beam 10 / 23 / **38** degree  
 2700K/**3000K**/4000K/6000K  
 installation  cut-out dia 155 mm

  IP20





code LDC385  
 casing aluminum / white painting  
 lamping cob 4x6W / Ra>90 / 2000LM  
 Beam 10 / 23 / **38** degree  
 2700K/**3000K**/4000K/6000K  
 installation  cut-out dia 155 mm

  IP20

# LED SPOT LIGHT



reflector available

surface customizable  white paint similar to RAL9003  anodized silver sandblasted  anodized gold sandblasted

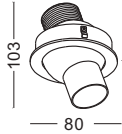
default  10° narrow beam  23° spot  38° flood



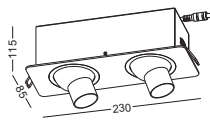

code LDC371  
 casing aluminum / anodized black  
 lamping cob 6W / Ra>90 / 500LM  
 Beam 10 / 23 / 38 degree  
 2700K/3000K/4000K/6000K  
 installation  cut-out dia 75 mm

  IP20



code LDC372  
 casing aluminum / anodized black  
 lamping cob 2x6W / Ra>90 / 1000LM  
 Beam 10 / 23 / 38 degree  
 2700K/3000K/4000K/6000K  
 installation  cut-out 210x77 mm

  IP20

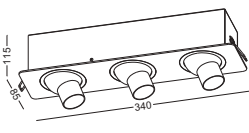



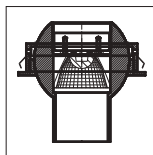

code LDC373  
 casing aluminum / anodized black  
 lamping cob 3x6W / Ra>90 / 1500LM  
 Beam 10 / 23 / 38 degree  
 2700K/3000K/4000K/6000K  
 installation  cut-out 320x77mm



deep recessed shielding angle up to 70 degree



 30°  30°  
 universal turning vertical and horizontal 30 degree

  IP20

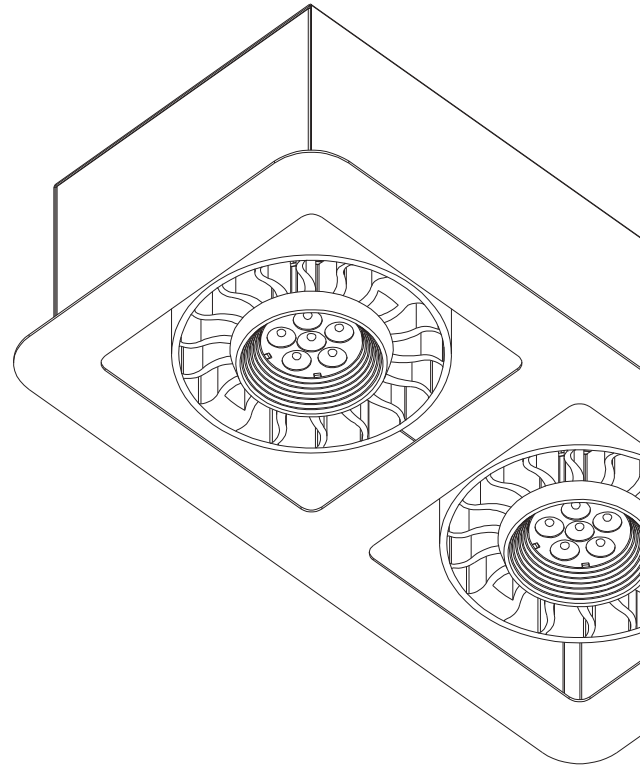
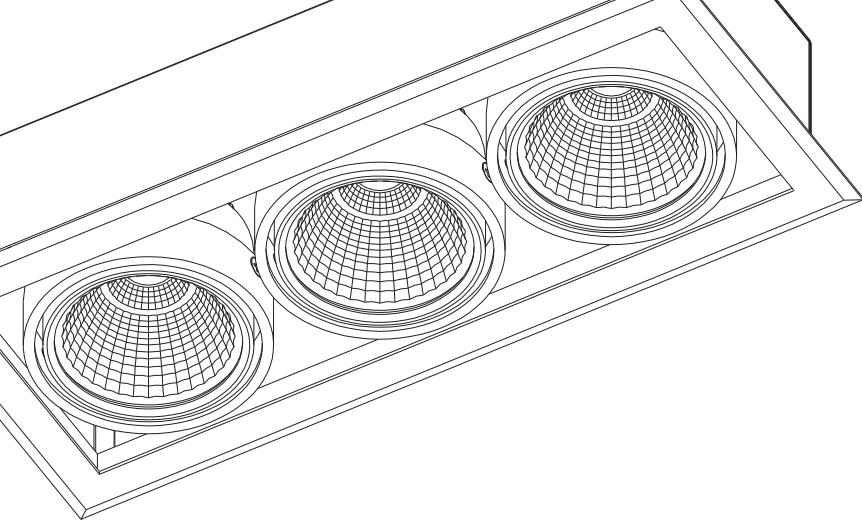

# LED GRILLE LIGHTS





code LDC955  
 casing aluminum / white painting  
 lamping cob 5W / Ra>90 / 430LM  
 Beam 15 / 24 / **38** / 60 degree  
 2700K/**3000K**/4000K/6000K  
 installation cut-out 90x90mm

code LDC956  
 casing aluminum / white painting  
 lamping cob 2x5W / Ra>90 / 860LM  
 Beam 15 / 24 / **38** / 60 degree  
 2700K/**3000K**/4000K/6000K  
 installation cut-out 165x90mm



code LDC957  
 casing aluminum / white painting  
 lamping cob 3x5W / Ra>90 / 1290LM  
 Beam 15 / 24 / **38** / 60 degree  
 2700K/**3000K**/4000K/6000K  
 installation cut-out 240x90mm

surface customizable  
 ■ black paint equal to RAL9011  
 ■ concrete grey paint similar to RAL7037

reflector available  
 15° narrow beam  
 24° spot  
 38° flood (default)  
 60° wide flood



code LDC958  
 casing aluminum / white painting  
 lamping cob 9W / Ra>90 / 800LM  
 Beam 15 / 24 / **38** / 60 degree  
 2700K/**3000K**/4000K/6000K  
 installation cut-out 110x110mm

code LDC959  
 casing aluminum / white painting  
 lamping cob 2x9W / Ra>90 / 1600LM  
 Beam 15 / 24 / **38** / 60 degree  
 2700K/**3000K**/4000K/6000K  
 installation cut-out 205x110mm



code LDC960  
 casing aluminum / white painting  
 lamping cob 3x9W / Ra>90 / 2400LM  
 Beam 15 / 24 / **38** / 60 degree  
 2700K/**3000K**/4000K/6000K  
 installation cut-out 300x110mm

surface customizable

- black paint equal to RAL9011
- concrete grey paint similar to RAL7037

reflector available

15° narrow beam	24° spot	38° flood	60° wide flood
		default	



code LDC961  
 casing aluminum / white painting  
 lamping cob 12W / Ra>90 / 900LM  
 Beam 15 / 24 / **38** / 60 degree  
 2700K/**3000K**/4000K/6000K  
 installation cut-out 135x135mm

code LDC963  
 casing aluminum / white painting  
 lamping cob 3x 12W / Ra>90 / 2700LM  
 Beam 15 / 24 / **38** / 60 degree  
 2700K/**3000K**/4000K/6000K  
 installation cut-out 365x135mm

surface customizable

- black paint equal to RAL9011
- concrete grey paint similar to RAL7037

reflector available

default

15° narrow beam

24° spot

38° flood

60° wide flood



code LDC962  
 casing aluminum / white painting  
 lamping cob 2x 12W / Ra>90 / 1800LM  
 Beam 15 / 24 / **38** / 60 degree  
 2700K/**3000K**/4000K/6000K  
 installation cut-out 250x135mm







code LDC940  
 casing aluminum / white painting  
 lamping LED 3W / Ra>80 /300LM  
 Beam 10 / 20 / **30** degree  
 2700K/**3000K**/4000K/6000K  
 installation cut-out 90x90mm

code LDC941  
 casing aluminum / white painting  
 lamping LED 2x3W / Ra>80 /600LM  
 Beam 10 / 20 / **30** degree  
 2700K/**3000K**/4000K/6000K  
 installation cut-out 165x90mm



code LDC942  
 casing aluminum / white painting  
 lamping LED 3x3W / Ra>80 /900LM  
 Beam 10 / 20 / **30** degree  
 2700K/**3000K**/4000K/6000K  
 installation cut-out 240x90mm

surface customizable

- black paint equal to RAL9011
- concrete grey paint similar to RAL7037

Lens available

10° narrow beam  
 20° spot  
 30° flood default



code LDC946  
 casing aluminum / white painting  
 lamping LED 7W / Ra>80 / 700LM  
 Beam 10 / 20 / 30 degree  
 2700K/3000K/4000K/6000K  
 installation cut-out 110x110mm

code LDC947  
 casing aluminum / white painting  
 lamping LED 2x7W / Ra>80 / 1400LM  
 Beam 10 / 20 / 30 degree  
 2700K/3000K/4000K/6000K  
 installation cut-out 205x110mm

code LDC948  
 casing aluminum / white painting  
 lamping cob 3x7W / Ra>80 / 2100LM  
 Beam 10 / 20 / 30 degree  
 2700K/3000K/4000K/6000K  
 installation cut-out 300x110mm

surface customizable

- black paint equal to RAL9011
- concrete grey paint similar to RAL7037

Lens available

- 10° narrow beam
- 20° spot
- 30° default flood





code LDC952  
 casing aluminum / white painting  
 lamping LED 12W / Ra>80 / 1200LM  
 Beam 10 / 20 / **30** degree  
 2700K/**3000K**/4000K/6000K  
 installation cut-out 135x135mm

code LDC953  
 casing aluminum / white painting  
 lamping LED 2x 12W / Ra>80 / 2400LM  
 Beam 10 / 20 / **30** degree  
 2700K/**3000K**/4000K/6000K  
 installation cut-out 250x135mm



code LDC954  
 casing aluminum / white painting  
 lamping cob 3x 12W / Ra>80 / 3600LM  
 Beam 10 / 20 / **30** degree  
 2700K/**3000K**/4000K/6000K  
 installation cut-out 365x135mm

surface customizable

- black paint equal to RAL9011
- concrete grey paint similar to RAL7037

Lens available

10° narrow beam  
 20° spot  
 30° flood (default)







code LDC923  
 casing aluminum / white painting  
 lamping LED 6x2W / Ra>80 / 660LM  
 Beam 10 / 20 / **30** degree  
 2700K/**3000K**/4000K/6000K  
 installation cut-out 135x135mm

code LDC924  
 casing aluminum / white painting  
 lamping LED 2x6x2W / Ra>80 / 1320LM  
 Beam 10 / 20 / **30** degree  
 2700K/**3000K**/4000K/6000K  
 installation cut-out 265x135mm

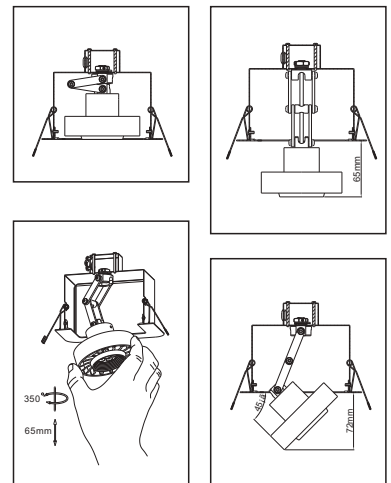

code LDC925  
 casing aluminum / white painting  
 lamping LED 3x6x2W / Ra>80 / 1980LM  
 Beam 10 / 20 / **30** degree  
 2700K/**3000K**/4000K/6000K  
 installation cut-out 395x135mm

surface customizable

- black paint equal to RAL9011
- concrete grey paint similar to RAL7037

Lens available

15° spot

30° flood

60° wide flood (default)









code LDC889  
 casing aluminum / white painting  
 lamping LED 3x3W / Ra>80 /360LM  
 Beam 10 / 20 / **30** degree  
 2700K/**3000K**/4000K/6000K  
 installation cut-out 105x105mm

code LDC890  
 casing aluminum / white painting  
 lamping LED 2x3x3W / Ra>80 /720LM  
 Beam 10 / 20 / **30** degree  
 2700K/**3000K**/4000K/6000K  
 installation cut-out 204x105mm



code LDC891  
 casing aluminum / white painting  
 lamping LED 3x3x3W / Ra>80 /1080LM  
 Beam 10 / 20 / **30** degree  
 2700K/**3000K**/4000K/6000K  
 installation cut-out 303x105mm

surface customizable

- black paint equal to RAL9011
- concrete grey paint similar to RAL7037

Lens available

15° spot  
 30° flood  
 60° wide flood (default)



# FREE ROTATE LED GRILLE LIGHTS



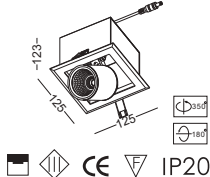



code LDC317  
 casing aluminum / white painting  
 lamping cob 5W / Ra>90 / 430LM  
 Beam 15 / 24 / 38 / 60 degree  
 2700K/3000K/4000K/6000K  
 installation  cut-out 105x105mm

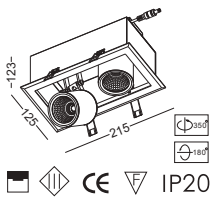



code LDC318  
 casing aluminum / white painting  
 lamping cob 2x5W / Ra>90 / 860LM  
 Beam 15 / 24 / 38 / 60 degree  
 2700K/3000K/4000K/6000K  
 installation  cut-out 195x105mm



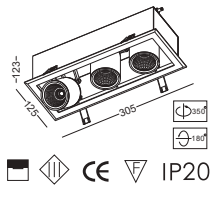





code LDC319  
 casing aluminum / white painting  
 lamping cob 3x5W / Ra>90 / 1290LM  
 Beam 15 / 24 / 38 / 60 degree  
 2700K/3000K/4000K/6000K  
 installation  cut-out 285x105mm

surface customizable

- black paint equal to RAL9011
- concrete grey paint similar to RAL7037

reflector available

- |   |  |   |  |
|---|--|---|--|
| <br>15°<br>narrow beam | <br>24°<br>spot | <br>38°<br>flood | <br>60°<br>wide flood |
|   |  | default   |  |

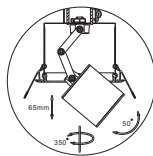

The led head can be pulled out and in and rotatable horizontally 350 degree vertically 180 degree



This series are remarkable for its' highly free rotating lamp head. Good solution for wall washing and signboard lighting

# FREE ROTATE LED GRILLE LIGHTS

## BIG VERSION



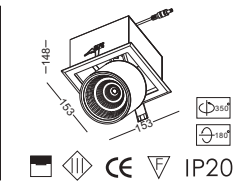

code LDC320

casing aluminum / white painting

lampping cob 12W / Ra>90 / 900LM

Beam 15 / 24 / **38** / 60 degree

2700K/**3000K**/4000K/6000K

installation  cut-out 135x135mm



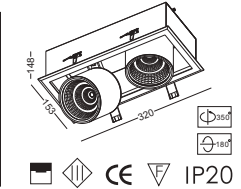

code LDC321

casing aluminum / white painting

lampping cob 2x12W / Ra>90 / 1800LM

Beam 15 / 24 / **38** / 60 degree

2700K/**3000K**/4000K/6000K

installation  cut-out 300x135mm





code LDC322

casing aluminum / white painting

lampping cob 3x12W / Ra>90 / 2700LM

Beam 15 / 24 / **38** / 60 degree

2700K/**3000K**/4000K/6000K

installation  cut-out 440x135mm

surface customizable

- black paint equal to RAL9011
- concrete grey paint similar to RAL7037

reflector available

- |             |            |                       |            |
|-------------|------------|-----------------------|------------|
| <b>15°</b>  | <b>24°</b> | default<br><b>38°</b> | <b>60°</b> |
| narrow beam | spot       | flood                 | wide flood |

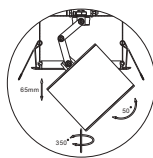

The led head can be pulled out and in and rotatable horizontally 350 degree vertically 180 degree



This series are remarkable for its' highly free rotating lamp head. Good solution for wall washing and signboard lighting

# HIGH CLASS / HIGH LUMENS LED GRILLE LIGHTS

---

UP TO 28W FOR SINGLE HEAD  
UP TO 6720 LUMENS FOR  
3 HEADS LAMP

10/23/38 DEGREE BEAM ANGLE  
SOLID AND EASY INSTALLATION

VERY GOOD HEAT  
MANAGEMENT

SUPPLIED WITH  
PHILIPS POWER-SUPPLY

20W/24W/28W AVAILABLE

LASER-CUT COVER SHEET  
CAN BE CUSTOMIZED TO  
OTHER SHAPE

ONE OF THE BEST CHOICE  
FOR ARCHITECTURE  
LIGHTING



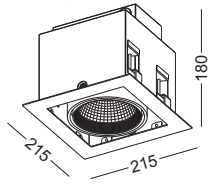

cut-out 180x180mm  
 IP20

code	casing	finishing	lamping	CRI	lumen	Beam/degree	LED color
LDC211-20W	steel casing aluminum heat sink	white painting	CREE COB 1816 20W	Ra>90	1600lm	10/23/38	2700K/3000K /4000K/6000K
LDC211-24W	steel casing aluminum heat sink	white painting	CREE COB 1816 24W	Ra>90	1920lm	10/23/38	2700K/3000K /4000K/6000K
LDC211-28W	steel casing aluminum heat sink	white painting	CREE COB 1820 28W	Ra>90	2240lm	10/23/38	2700K/3000K /4000K/6000K

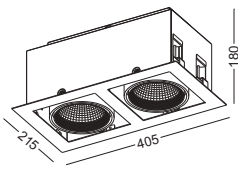

cut-out 365x180mm  
 IP20

code	casing	finishing	lamping	CRI	lumen	Beam/degree	LED color
LDC212-20W	steel casing aluminum heat sink	white painting	CREE COB 1816 2X20W	Ra>90	3200lm	10/23/38	2700K/3000K /4000K/6000K
LDC212-24W	steel casing aluminum heat sink	white painting	CREE COB 1816 2X24W	Ra>90	3840lm	10/23/38	2700K/3000K /4000K/6000K
LDC212-28W	steel casing aluminum heat sink	white painting	CREE COB 1820 2X28W	Ra>90	4480lm	10/23/38	2700K/3000K /4000K/6000K

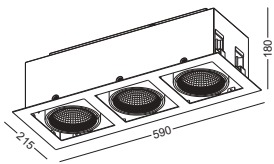

cut-out 550x180mm  
 IP20

code	casing	finishing	lamping	CRI	lumen	Beam/degree	LED color
LDC213-20W	steel casing aluminum heat sink	white painting	CREE COB 1816 3X20W	Ra>90	4800lm	10/23/38	2700K/3000K /4000K/6000K
LDC213-24W	steel casing aluminum heat sink	white painting	CREE COB 1816 3X24W	Ra>90	5760lm	10/23/38	2700K/3000K /4000K/6000K
LDC213-28W	steel casing aluminum heat sink	white painting	CREE COB 1820 3X28W	Ra>90	6720lm	10/23/38	2700K/3000K /4000K/6000K

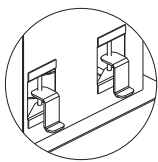

hiding-screwing out-screwing down  
 3 steps installation module makes  
 NO HARM to the roof and lamp itself  
 Very stable ceiling lamp installation



1.5mm thickness  
 Laser-cut integrated  
 steel cover sheet  
 gives enough intensity

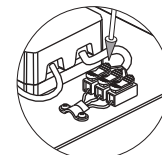

quick pressing  
 connector  
 makes installation  
 easy

surface  
 customizable

- black paint equal to RAL9011
- concrete grey paint similar to RAL7037

reflector available

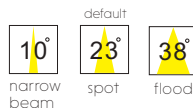

15mm aluminum  
 front cover and  
 reflector makes  
 45 degree  
 shielding angle

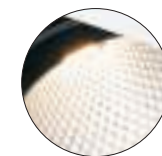

Lenes on the  
 central of  
 reflector  
 makes the light  
 soft and more  
 efficient

HIGH CLASS / HIGH LUMENS  
LED GRILLE LIGHTS

---

RIMLESS VERSION

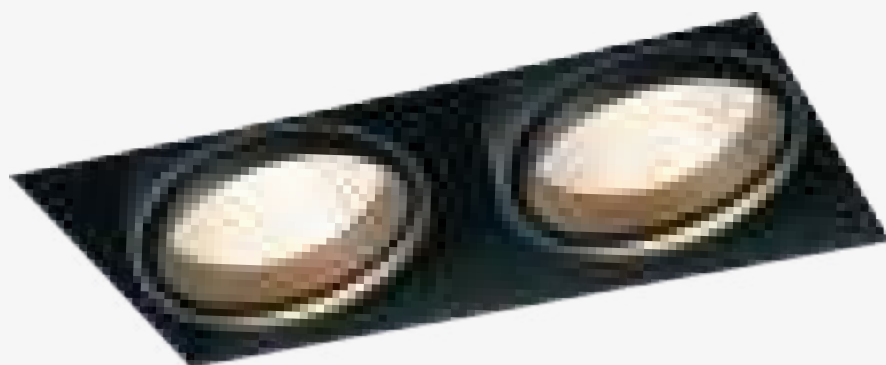

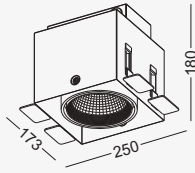

cut-out 185x180mm

code	casing	finishing	lamping	CRI	lumen	Beam/degree	LED color
LDC214-20W	steel casing aluminum heat sink	white painting	CREE COB 18 16 20W	Ra>90	1600lm	10/23/38	2700K/3000K /4000K/6000K
LDC214-24W	steel casing aluminum heat sink	white painting	CREE COB 18 16 24W	Ra>90	1920lm	10/23/38	2700K/3000K /4000K/6000K
LDC214-28W	steel casing aluminum heat sink	white painting	CREE COB 18 20 28W	Ra>90	2240lm	10/23/38	2700K/3000K /4000K/6000K

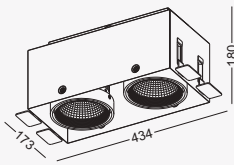

cut-out 370x180mm

code	casing	finishing	lamping	CRI	lumen	Beam/degree	LED color
LDC215-20W	steel casing aluminum heat sink	white painting	CREE COB 18 16 2X20W	Ra>90	3200lm	10/23/38	2700K/3000K /4000K/6000K
LDC215-24W	steel casing aluminum heat sink	white painting	CREE COB 18 16 2X24W	Ra>90	3840lm	10/23/38	2700K/3000K /4000K/6000K
LDC215-28W	steel casing aluminum heat sink	white painting	CREE COB 18 20 2X28W	Ra>90	4480lm	10/23/38	2700K/3000K /4000K/6000K

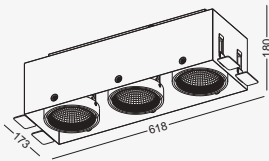

cut-out 555x180mm

code	casing	finishing	lamping	CRI	lumen	Beam/degree	LED color
LDC216-20W	steel casing aluminum heat sink	white painting	CREE COB 18 16 3X20W	Ra>90	4800lm	10/23/38	2700K/3000K /4000K/6000K
LDC216-24W	steel casing aluminum heat sink	white painting	CREE COB 18 16 3X24W	Ra>90	5760lm	10/23/38	2700K/3000K /4000K/6000K
LDC216-28W	steel casing aluminum heat sink	white painting	CREE COB 18 20 3X28W	Ra>90	6720lm	10/23/38	2700K/3000K /4000K/6000K



easy installation  
by putting by hands  
put the lamp into  
the ceiling hole with  
one side oblique



The holding pieces  
can be adjusted  
by customer  
according to the  
thickness of the  
ceiling board

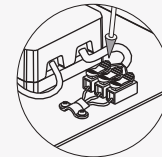

quick pressing  
connector  
makes installation  
easy

surface  
customizable

- black paint  
equal to RAL9011
- concrete grey paint  
similar to RAL7037

reflector available

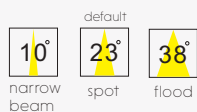

15mm aluminum  
front cover and  
reflector makes  
45 degree  
shielding angle



Lenes on the  
central of  
reflector  
makes the light  
soft and more  
efficient



# RIMLESS LED GRILLE LIGHTS



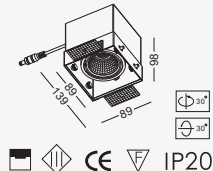

code LDC356

casing aluminum / black painting

lampping cob 6W / Ra>90 / 500LM

Beam 10 / 23 / 38 degree

2700K/3000K/4000K/6000K

installation  cut-out 93x93mm



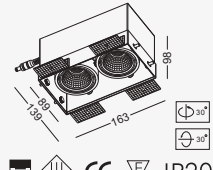

code LDC357

casing aluminum / black painting

lampping cob 2x6W / Ra>90 / 1000LM

Beam 10 / 23 / 38 degree

2700K/3000K/4000K/6000K

installation  cut-out 165x93mm

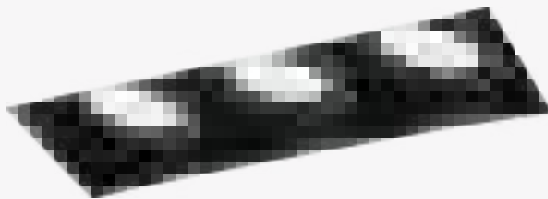

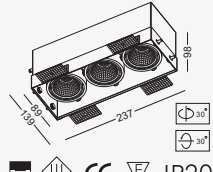

code LDC358

casing aluminum / black painting

lampping cob 3x6W / Ra>90 / 1500LM

Beam 10 / 23 / 38 degree

2700K/3000K/4000K/6000K

installation  cut-out 240x93mm

reflector available

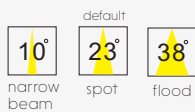

installation guide

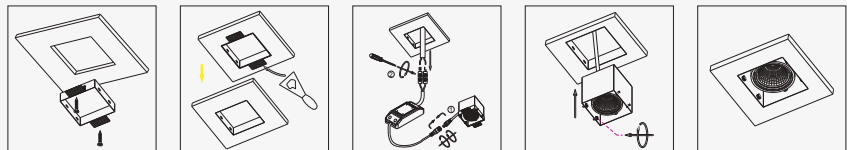

surface customizable

- white paint similar to RAL9003
- concrete grey paint similar to RAL7037



# RIMLESS LED GRILLE LIGHTS



	code	LDC359
	casing	aluminum / black painting
	lampping	cob 9W / Ra>90 / 800LM
	Beam	10 / 23 / 38 degree 2700K/3000K/4000K/6000K
	installation	cut-out 114x114mm



	code	LDC360
	casing	aluminum / black painting
	lampping	cob 2x9W / Ra>90 / 1600LM
	Beam	10 / 23 / 38 degree 2700K/3000K/4000K/6000K
	installation	cut-out 209x114mm

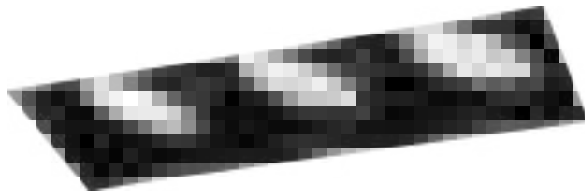

	code	LDC361
	casing	aluminum / black painting
	lampping	cob 3x9W / Ra>90 / 2400LM
	Beam	10 / 23 / 38 degree 2700K/3000K/4000K/6000K
	installation	cut-out 304x114mm

## installation guide

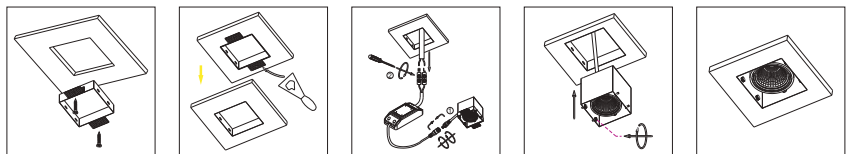

surface customizable

- white paint similar to RAL9003
- concrete grey paint similar to RAL7037

reflector available

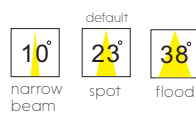

# RIMLESS LED GRILLE LIGHTS

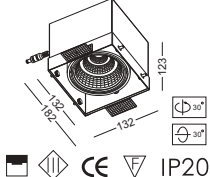

code LDC362  
 casing aluminum / black painting  
 lamping cob 12W / Ra>90 / 900LM  
 Beam 10 / 23 / 38 degree  
 2700K/3000K/4000K/6000K  
 installation  cut-out 136x136mm

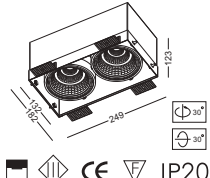
code LDC363  
 casing aluminum / black painting  
 lamping cob 2x12W / Ra>90 / 1800LM  
 Beam 10 / 23 / 38 degree  
 2700K/3000K/4000K/6000K  
 installation  cut-out 253x136mm

code LDC364  
 casing aluminum / black painting  
 lamping cob 3x12W / Ra>90 / 2700LM  
 Beam 10 / 23 / 38 degree  
 2700K/3000K/4000K/6000K  
 installation  cut-out 370x136mm

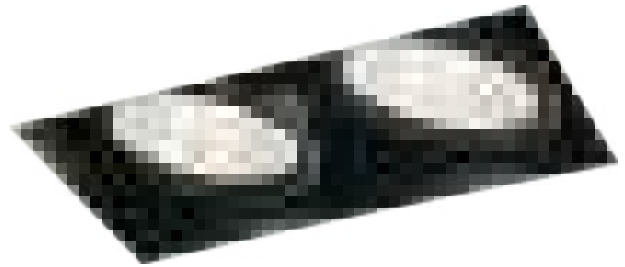
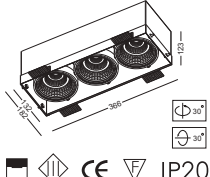

## installation guide

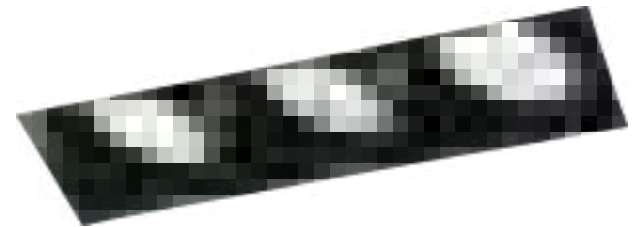
surface customizable

-  white paint similar to RAL9003
-  concrete grey paint similar to RAL7037

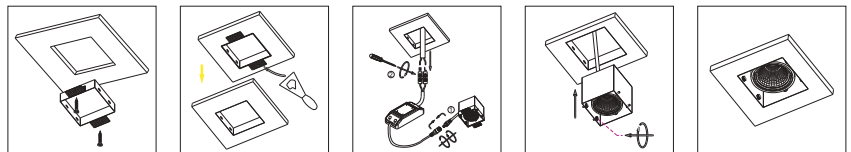

reflector available

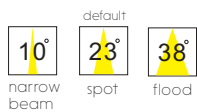

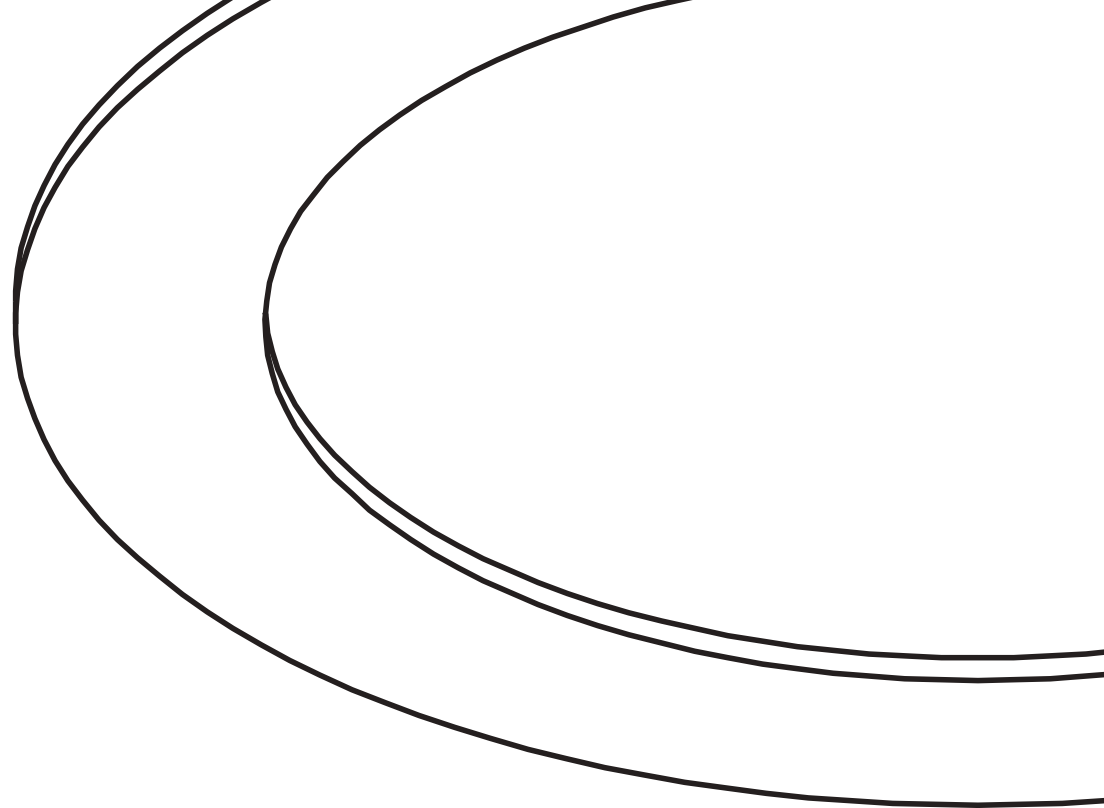

LED

DOWN

LIGHT



## ANTI-GLARE LED DOWNLIGHT

---



This series LED downlight has got 3 different sizes and 3 different colors, so totally 9 items.  
3 inches is Dia 105mm by 59mm height, with cut-off Dia 90mm  
4 inches is Dia 128mm by 59mm height, with cut-off Dia 115mm  
6 inches is Dia 175mm by 59mm height, with cut-off Dia 160mm

Those items are good at kitchen, toilet ceiling and for bedside lighting, also passage is a good place to put this series, for the elegant out-looking and anti-glare shade.

The second advantage from this series is the lamp color: aluminium anodized silver and gold is giving a metallic looking, clear, modern but not vulgar like shining chrome.

# ANTI-GLARE LED DOWNLIGHT



surface  
customizable

- black paint  
equal to RAL9011
- concrete grey paint  
similar to RAL7037

equal to 3 inch

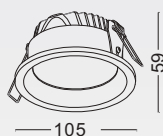

- cut-out Dia 90mm
- IP20

code	casing	finishing	lamping	CRI	lumen	Beam/degree	LED color
LDC931A-SL	aluminum	anodized silver	SMD 6W	Ra>80	600lm	Acrylic cover	2700K/ <b>3000K</b> /4000K/6000K
LDC931A-GD	aluminum	anodized gold	SMD 6W	Ra>80	600lm	Acrylic cover	2700K/ <b>3000K</b> /4000K/6000K
LDC931A-WT	aluminum	white paint	SMD 6W	Ra>80	600lm	Acrylic cover	2700K/ <b>3000K</b> /4000K/6000K

equal to 4 inch

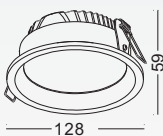

- cut-out Dia 115mm
- IP20

code	casing	finishing	lamping	CRI	lumen	Beam/degree	LED color
LDC932A-SL	aluminum	anodized silver	SMD 10W	Ra>80	1000lm	Acrylic cover	2700K/ <b>3000K</b> /4000K/6000K
LDC932A-GD	aluminum	anodized gold	SMD 10W	Ra>80	1000lm	Acrylic cover	2700K/ <b>3000K</b> /4000K/6000K
LDC932A-WT	aluminum	white paint	SMD 10W	Ra>80	1000lm	Acrylic cover	2700K/ <b>3000K</b> /4000K/6000K

equal to 6 inch

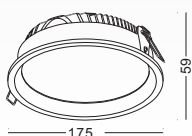

- cut-out Dia 160mm
- IP20

code	casing	finishing	lamping	CRI	lumen	Beam/degree	LED color
LDC934A-SL	aluminum	anodized silver	SMD 20W	Ra>80	2000lm	Acrylic cover	2700K/ <b>3000K</b> /4000K/6000K
LDC934A-GD	aluminum	anodized gold	SMD 20W	Ra>80	2000lm	Acrylic cover	2700K/ <b>3000K</b> /4000K/6000K
LDC934A-WT	aluminum	white paint	SMD 20W	Ra>80	2000lm	Acrylic cover	2700K/ <b>3000K</b> /4000K/6000K





## ANTI-GLARE LED DOWNLIGHT

We create this series to make a universal led down light for replacement of normal fluorescence down light. From 2 inch/size diameter 75mm to 5 inch/size diameter 160mm, you can always find the size you want. We use very economics SMD led chips inside, but very efficiency led, up to 100 lm per watt. Another advantage of this series is very slim lamp body due to the good heat management design, the height of total lamp is less than 60mm and it can fit for most of ceiling.

The front reflector is made of spun aluminum and chrome plated. Aluminum will never rust. Comparing to the traditional down light, this series is a very good alternative.

surface  
customizable

 black paint  
equal to RAL9011

 concrete grey paint  
similar to RAL7037

   IP20

		code	casing	finishing	lamping	CRI	lumen	Beam/degree	LED color
equal to 2 inch	Dia75mm	LDC858C	aluminum	white paint	SMD 3W	Ra>80	300lm	Acrylic cover	2700K/3000K/4000K/6000K
		code	casing	finishing	lamping	CRI	lumen	Beam/degree	LED color
equal to 3 inch	Dia90mm	LDC859C	aluminum	white paint	SMD 4W	Ra>80	400lm	Acrylic cover	2700K/3000K/4000K/6000K
		code	casing	finishing	lamping	CRI	lumen	Beam/degree	LED color
equal to 3.5 inch	Dia100mm	LDC860C	aluminum	white paint	SMD 6W	Ra>80	600lm	Acrylic cover	2700K/3000K/4000K/6000K
		code	casing	finishing	lamping	CRI	lumen	Beam/degree	LED color
equal to 4 inch	Dia115mm	LDC861C	aluminum	white paint	SMD 10W	Ra>80	1000lm	Acrylic cover	2700K/3000K/4000K/6000K
		code	casing	finishing	lamping	CRI	lumen	Beam/degree	LED color
equal to 4.5 inch	Dia130mm	LDC862C	aluminum	white paint	SMD 16W	Ra>80	1600lm	Acrylic cover	2700K/3000K/4000K/6000K
		code	casing	finishing	lamping	CRI	lumen	Beam/degree	LED color
equal to 5 inch	Dia145mm	LDC863C	aluminum	white paint	SMD 20W	Ra>80	2000lm	Acrylic cover	2700K/3000K/4000K/6000K

## LED DOWNLIGHT

We call this series MOOOON, because the original idea of the lamp comes from the FULL MOON, the moon at middle of the month is totally round and nothing defected. This series of lamp lights up just like full moon, very thin edge, the object is totally like a lighting ball from the ceiling, well-stacked and beautiful.









They have got four sizes 3 inches, 4 inches, 5 inches, and 6 inches. Also two colors available, painted white and anodized brushed silver. They give enough light, good for passage, balcony, toilet, kitchen, and etc.

surface  
customizable

-  black paint  
equal to RAL9011
-  concrete grey paint  
similar to RAL7037

    IP20



	 Dia 60mm	code	casing	finishing	lamping	CRI	lumen	Beam/degree	LED color
		LDC964-WT	aluminum	white paint	SMD 6W	Ra>80	600lm	Acrylic cover	2700K/ <del>3000K</del> /4000K/6000K
	 Dia 90mm	code	casing	finishing	lamping	CRI	lumen	Beam/degree	LED color
		LDC965-WT	aluminum	white paint	SMD 10W	Ra>80	1000lm	Acrylic cover	2700K/ <del>3000K</del> /4000K/6000K
	 Dia 125mm	code	casing	finishing	lamping	CRI	lumen	Beam/degree	LED color
		LDC966-WT	aluminum	white paint	SMD 16W	Ra>80	1600lm	Acrylic cover	2700K/ <del>3000K</del> /4000K/6000K
	 Dia 140mm	code	casing	finishing	lamping	CRI	lumen	Beam/degree	LED color
		LDC967-WT	aluminum	white paint	SMD 20W	Ra>80	2000lm	Acrylic cover	2700K/ <del>3000K</del> /4000K/6000K



## CEILING RECESSED LED PANNEL LIGHT ULTRA SLIM AND BRIGHTNESS

We call this type of lamp PANEL LIGHT, because the whole lamp is extremely slim, just like a panel. The theory of panel light is putting the led on the side of the lamp casing, 90 degree opposite of the lighting direction. There are three layers of acrylic lighting unit, on the front is a very thin acrylic sheet to make the light soft, the middle layer is a diffuser which turning the lighting direction from side to downwards, the back layer is a reflector to reflect the lighting downwards, the led give lights to the acrylic panels, the three layers of acrylic make the light all downwards to the ground.

This type of PNAEL LIGHT is very slim, efficient, soft light and other lots of advantage. We have got four sizes from 105mm to 280mm, the watt from 6W to 24W, it can fulfill most requirements.

There are also round shape and square shape, black and white color, and also other color can be custom made.



# LED PANEL DOWNLIGHT | DATASHEET



 IP20

surface customizable  concrete grey paint similar to RAL7037

		code	casing	finishing	lamping	CRI	lumen	Beam/degree	LED color
	 Dia105mm	LDC201S-WT	aluminum	white paint	SMD 6W	Ra>80	600lm	Acrylic cover	2700K/3000K /4000K/6000K
	 Dia160mm	LDC201-WT	aluminum	white paint	SMD 12W	Ra>80	1200lm	Acrylic cover	2700K/3000K /4000K/6000K
	 Dia205mm	LDC202-WT	aluminum	white paint	SMD 18W	Ra>80	1800lm	Acrylic cover	2700K/3000K /4000K/6000K
	 Dia280mm	LDC203-WT	aluminum	white paint	SMD 24W	Ra>80	2400lm	Acrylic cover	2700K/3000K /4000K/6000K
	 Dia105mm	LDC201S-BK	aluminum	black paint	SMD 6W	Ra>80	600lm	Acrylic cover	2700K/3000K /4000K/6000K
	 Dia160mm	LDC201-BK	aluminum	black paint	SMD 12W	Ra>80	1200lm	Acrylic cover	2700K/3000K /4000K/6000K
	 Dia205mm	LDC202-BK	aluminum	black paint	SMD 18W	Ra>80	1800lm	Acrylic cover	2700K/3000K /4000K/6000K
	 Dia280mm	LDC203-BK	aluminum	black paint	SMD 24W	Ra>80	2400lm	Acrylic cover	2700K/3000K /4000K/6000K



CEILING RECESSED  
LED PANNEL LIGHT  
ULTRA SLIM AND  
BRIGHTNESS

We call this type of lamp PANEL LIGHT, because the whole lamp is extremely slim ,just like a panel. The theory of panel light is putting the led on the side of the lamp casing, 90 degree opposite of the lighting direction. There are three layers of acrylic lighting unit , on the front is a very thin acrylic sheet to make the light soft, the middle layer is a diffuser which turning the lighting direction from side to downwards, the back layer is a reflector to reflect the lighting downwards the led give lights to the acrylic panels, the three layers of acrylic make the light all downwards to the ground.

This type of PNAEL LIGHT is very slim, efficient, soft light and other lots of advantage. We have got four sizes from 105mm to 280mm, the watt from 6W to 24W, it can fulfill most requirements. There are also round shape and square shape, black and white color, and also other color can be custom made.

# LED PANEL DOWNLIGHT | DATASHEET



surface customizable  concrete grey paint similar to RAL7037

	code	casing	finishing	lamping	CRI	lumen	Beam/degree	LED color
 <p>↻ Dia 105x105mm</p>	LDC204S-WT	aluminum	white paint	SMD 6W	Ra>80	600lm	Acrylic cover	2700K/ <b>3000K</b> /4000K/6000K
 <p>↻ Dia 155x155mm</p>	LDC204-WT	aluminum	white paint	SMD 12W	Ra>80	1200lm	Acrylic cover	2700K/ <b>3000K</b> /4000K/6000K
 <p>↻ Dia 205x205mm</p>	LDC205-WT	aluminum	white paint	SMD 18W	Ra>80	1800lm	Acrylic cover	2700K/ <b>3000K</b> /4000K/6000K
 <p>↻ Dia 280x280mm</p>	LDC206-WT	aluminum	white paint	SMD 24W	Ra>80	2400lm	Acrylic cover	2700K/ <b>3000K</b> /4000K/6000K
 <p>↻ Dia 105x105mm</p>	LDC204S-BK	aluminum	black paint	SMD 6W	Ra>80	600lm	Acrylic cover	2700K/ <b>3000K</b> /4000K/6000K
 <p>↻ Dia 155x155mm</p>	LDC204-BK	aluminum	black paint	SMD 12W	Ra>80	1200lm	Acrylic cover	2700K/ <b>3000K</b> /4000K/6000K
 <p>↻ Dia 205x205mm</p>	LDC205-BK	aluminum	black paint	SMD 18W	Ra>80	1800lm	Acrylic cover	2700K/ <b>3000K</b> /4000K/6000K
 <p>↻ Dia 280x280mm</p>	LDC206-BK	aluminum	black paint	SMD 24W	Ra>80	2400lm	Acrylic cover	2700K/ <b>3000K</b> /4000K/6000K



LED  
CABINET  
LIGHTS



LSD014-BK



LSD013-BK

code **LSD014-BK**

surface customizable  anodized silver brushed linear  anodized silver sandblasted

casing aluminum / anodized black / lamping LED 1W / Ra>80 / 70LM / Beam 10/20/30 degree / 2700K/3000K/4000K/6000K

installation    IP20  cut-off dia 10mm hole for installation / maximum 25mm thickness board

code **LSD013-BK**

surface customizable  anodized silver brushed linear  anodized silver sandblasted

casing aluminum / anodized black / lamping LED 1W / Ra>80 / 70LM / Beam 10/20/30 degree / 2700K/3000K/4000K/6000K

installation    IP20  cut-off dia 10mm hole for installation / maximum 25mm thickness board





LSD014-CR



LSD013-CR

code **LSD014-CR**

surface customizable  anodized silver brushed linear  anodized silver sandblasted

casing aluminum / chrome plated / lamping LED 1W / Ra>80 / 70LM / Beam 10/20/30 degree / 2700K/3000K/4000K/6000K

installation    IP20  cut-off dia 10mm hole for installation / maximum 25mm thickness board

code **LSD013-CR**

surface customizable  anodized silver brushed linear  anodized silver sandblasted

casing aluminum / chrome plated / lamping LED 1W / Ra>80 / 70LM / Beam 10/20/30 degree / 2700K/3000K/4000K/6000K

installation    IP20  cut-off dia 10mm hole for installation / maximum 25mm thickness board





code **LSD016**

surface customizable  white paint similar to RAL9003  anodized silver sandblasted

casing aluminum / anodized black / lamping LED 1x1W / Ra>80 / 70LM / Beam 10/20/30 degree / 2700K/3000K/4000K/6000K

installation   IP20  cut-off dia 10mm hole for installation / maximum 25mm thickness board

code **LSD017**

surface customizable  white paint similar to RAL9003  anodized silver sandblasted

casing aluminum / anodized black / lamping LED 2x1W / Ra>80 / 140LM / Beam 10/20/30 degree / 2700K/3000K/4000K/6000K

installation   IP20  cut-off dia 10mm hole for installation / maximum 25mm thickness board

code **LSD018**

surface customizable  white paint similar to RAL9003  anodized silver sandblasted

casing aluminum / anodized black / lamping LED 3x1W / Ra>80 / 210LM / Beam 10/20/30 degree / 2700K/3000K/4000K/6000K

installation   IP20  cut-off dia 10mm hole for installation / maximum 25mm thickness board



code **LDC365**

surface customizable  white paint similar to RAL9003  anodized silver sandblasted

casing aluminum / anodized black / lamping LED 1x1W / Ra>80 / 70LM / Beam 10/20/**30** degree / 2700K/**3000K**/4000K/6000K

installation    IP20  cut-off dia 28mm hole precisely for installation / minimum 10mm thickness board



code **LDC368**

surface customizable  white paint similar to RAL9003  anodized silver sandblasted

casing aluminum / anodized black / lamping LED 1x3W / Ra>80 / 120LM / Beam 10/20/**30** degree / 2700K/**3000K**/4000K/6000K

installation    IP20  cut-off dia 40mm hole precisely for installation / minimum 10mm thickness board

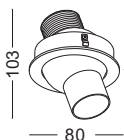

code **LDC371**

surface customizable  white paint similar to RAL9003  anodized silver sandblasted

casing aluminum / anodized black / lamping COB 6W / Ra>90 / 550LM / Beam 10/**23**/**38** degree / 2700K/**3000K**/4000K/6000K

installation    IP20  cut-off dia 75mm hole precisely for installation / minimum 10mm thickness board



LDC366



LDC367



LDC369



LDC370



LDC372



LDC373

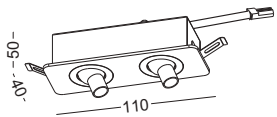

code **LDC366**

surface customizable  white paint similar to RAL9003  anodized silver sandblasted

casing aluminum / anodized black / lamping LED 2x1W / Ra>80 / 140LM / Beam 10/20/30 degree / 2700K/3000K/4000K/6000K  
 installation IP20 cut-off 100x35mm hole precisely for installation / minimum 10mm thickness board

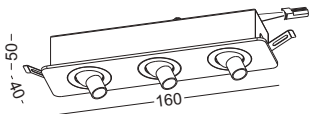

code **LDC367**

surface customizable  white paint similar to RAL9003  anodized silver sandblasted

casing aluminum / anodized black / lamping LED 3x1W / Ra>80 / 210LM / Beam 10/20/30 degree / 2700K/3000K/4000K/6000K  
 installation IP20 cut-off 150x35mm hole precisely for installation / minimum 10mm thickness board

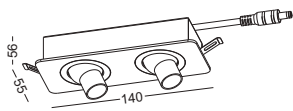

code **LDC369**

surface customizable  white paint similar to RAL9003  anodized silver sandblasted

casing aluminum / anodized black / lamping LED 2x3W / Ra>80 / 240LM / Beam 10/20/30 degree / 2700K/3000K/4000K/6000K  
 installation IP20 cut-off 130x47mm hole precisely for installation / minimum 10mm thickness board

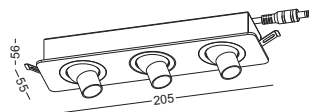

code **LDC370**

surface customizable  white paint similar to RAL9003  anodized silver sandblasted

casing aluminum / anodized black / lamping LED 3x3W / Ra>80 / 360LM / Beam 10/20/30 degree / 2700K/3000K/4000K/6000K  
 installation IP20 cut-off 195x47mm hole precisely for installation / minimum 10mm thickness board

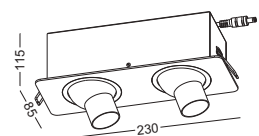

code **LDC372**

surface customizable  white paint similar to RAL9003  anodized silver sandblasted

casing aluminum / anodized black / lamping COB 2x6W / Ra>90 / 1100LM / Beam 10/23/38 degree / 2700K/3000K/4000K/6000K  
 installation IP20 cut-off 210x77mm hole precisely for installation / minimum 10mm thickness board



code **LDC373**

surface customizable  white paint similar to RAL9003  anodized silver sandblasted

casing aluminum / anodized black / lamping COB 3x6W / Ra>90 / 1650LM / Beam 10/23/38 degree / 2700K/3000K/4000K/6000K  
 installation IP20 cut-off 320x77mm hole precisely for installation / minimum 10mm thickness board











A photograph of a modern house at dusk. The sky is a gradient of purple and blue. The house has a white wall with a dark window and a dark door. A white pillar with the number '48' is visible. The house is illuminated by warm outdoor lights, including wall sconces and ground lights. The text 'LED OUTDOOR WALL LIGHTS' is overlaid in white, outlined font.

LED  
OUTDOOR  
WALL  
LIGHTS







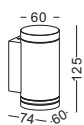

code **LWA215**  
 casing aluminum / black painting  
 lamping COB 6W / Ra>90 / 430LM  
 Beam 15/24/38/60 degree  
 2700K/3000K/4000K/6000K  
 installation     IP65





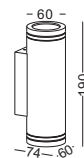

surface customizable  
 white paint similar to RAL9003  
 concrete grey paint similar to RAL7037

code **LWA216**  
 casing aluminum / black painting  
 lamping COB 2x6W / Ra>90 / 860LM  
 Beam 15/24/38/60 degree  
 2700K/3000K/4000K/6000K  
 installation     IP65







surface customizable  
 white paint similar to RAL9003  
 concrete grey paint similar to RAL7037

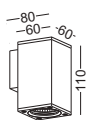

code **LWA253**  
 casing aluminum / black painting  
 lamping COB 6W / Ra>90 / 430LM  
 Beam 15/24/38/60 degree  
 2700K/3000K/4000K/6000K  
 installation     IP65



surface customizable  
 white paint similar to RAL9003  
 concrete grey paint similar to RAL7037

code **LWA254**  
 casing aluminum / black painting  
 lamping COB 2x6W / Ra>90 / 860LM  
 Beam 15/24/38/60 degree  
 2700K/3000K/4000K/6000K  
 installation     IP65

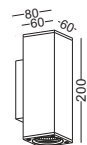





surface customizable  
 white paint similar to RAL9003  
 concrete grey paint similar to RAL7037









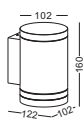

code **LWA217**  
 casing aluminum / black painting  
 lamping COB 12W / Ra>90 / 900LM  
 Beam 15/24/38/60 degree  
 2700K/3000K/4000K/6000K  
 installation     IP65





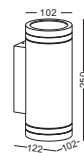

surface customizable  
 white paint similar to RAL9003  
 concrete grey paint similar to RAL7037

code **LWA218**  
 casing aluminum / black painting  
 lamping COB 2x12W / Ra>90 / 1800LM  
 Beam 15/24/38/60 degree  
 2700K/3000K/4000K/6000K  
 installation     IP65



surface customizable  
 white paint similar to RAL9003  
 concrete grey paint similar to RAL7037



code **LWA255**  
 casing aluminum / black painting  
 lamping COB 12W / Ra>90 / 900LM  
 Beam 15/24/38/60 degree  
 2700K/3000K/4000K/6000K  
 installation     IP65

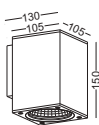

surface customizable  
 white paint similar to RAL9003  
 concrete grey paint similar to RAL7037

code **LWA256**  
 casing aluminum / black painting  
 lamping COB 2x12W / Ra>90 / 1800LM  
 Beam 15/24/38/60 degree  
 2700K/3000K/4000K/6000K  
 installation     IP65

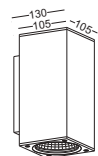





surface customizable  
 white paint similar to RAL9003  
 concrete grey paint similar to RAL7037





code **LWA173A**  
 casing aluminum / black painting  
 lamping COB 5W / Ra>90 / 430LM  
 Beam 15/24/38/60 degree  
 2700K/3000K/4000K/6000K  
 installation     IP65



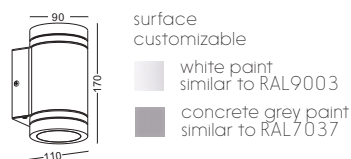

code **LWA174A**  
 casing aluminum / black painting  
 lamping COB 2x5W / Ra>90 / 860LM  
 Beam 15/24/38/60 degree  
 2700K/3000K/4000K/6000K  
 installation     IP65







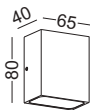

code **LWA250**  
 casing aluminum / black painting  
 lamping LED 1W / Ra>80 / 70LM  
 Beam NO LENSE  
 2700K/3000K/4000K/6000K  
 installation     IP65

surface customizable  
 white paint similar to RAL9003  
 concrete grey paint similar to RAL7037



code **LWA251**  
 casing aluminum / black painting  
 lamping LED 2X1W / Ra>80 / 140LM  
 Beam NO LENSE  
 2700K/3000K/4000K/6000K  
 installation     IP65

surface customizable  
 white paint similar to RAL9003  
 concrete grey paint similar to RAL7037

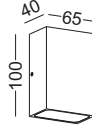

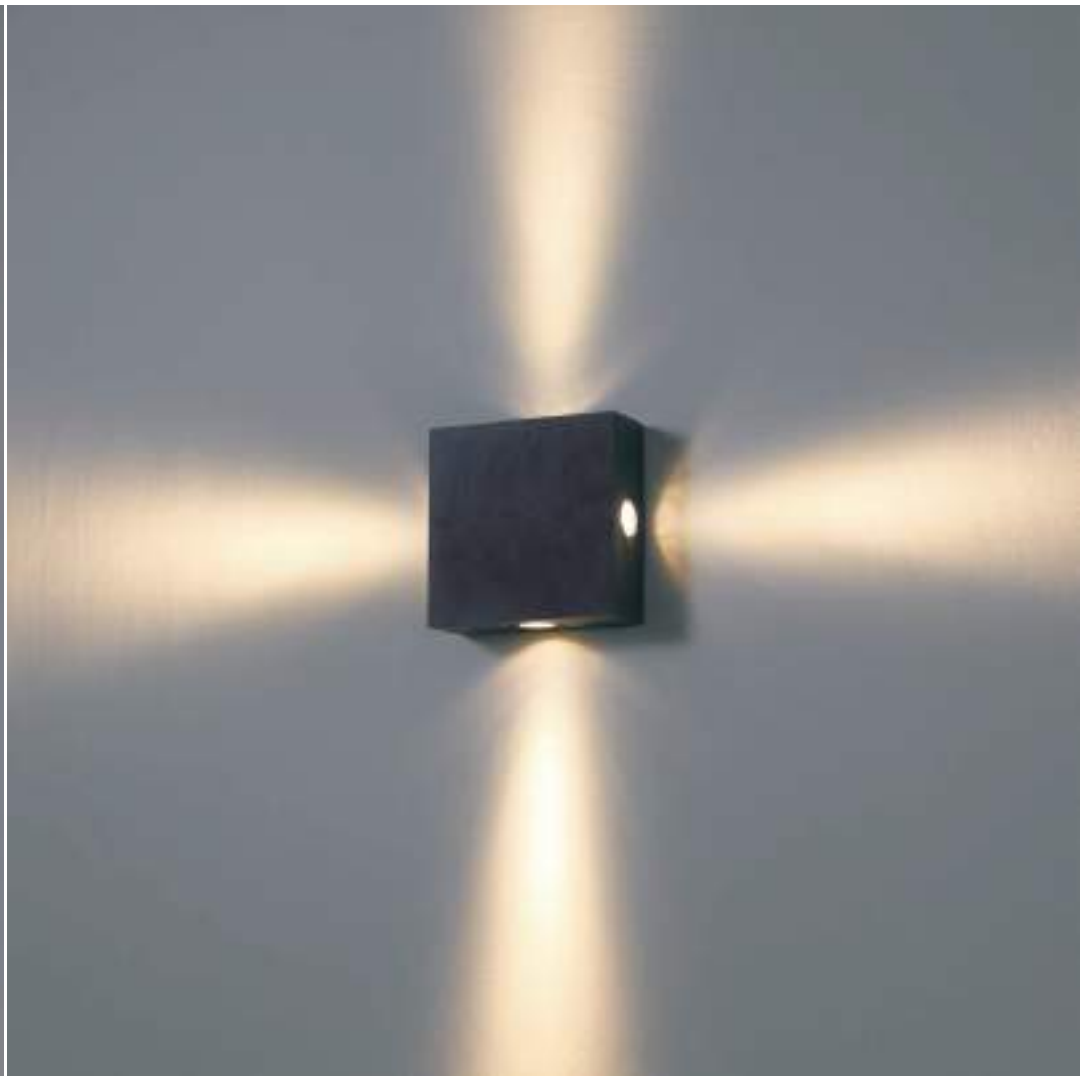

code **LWA248**

casing aluminum / black painting

lamping LED 2x3W / Ra>80 / 240LM

Beam 10/20/30 degree  
2700K/3000K/4000K/6000K

installation     IP65

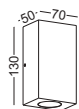

surface  
customizable

-  white paint  
similar to RAL9003
-  concrete grey paint  
similar to RAL7037

code **LWA249**

casing aluminum / black painting

lamping LED 4x3W / Ra>80 / 480LM

Beam 10/20/30 degree  
2700K/3000K/4000K/6000K



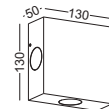

installation     IP65



surface  
customizable

-  white paint  
similar to RAL9003
-  concrete grey paint  
similar to RAL7037



code **LWA213**  
 casing aluminum / black painting  
 lamping COB 9W / Ra>90 /800LM  
 Beam acrylic diffuser  
 2700K/**3000K**/4000K/6000K  
 installation     IP65

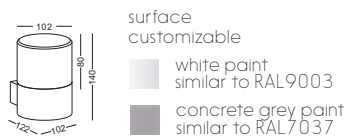

code **LWA214**  
 casing aluminum / black painting  
 lamping COB 9W / Ra>90 /800LM  
 Beam acrylic diffuser  
 2700K/**3000K**/4000K/6000K  
 installation     IP65

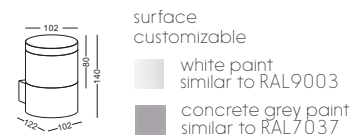



code **LWA210**

casing aluminum / black painting

lamping COB 6W / Ra>90 / 430LM

Beam acrylic diffuser

2700K/3000K/4000K/6000K

installation     IP65

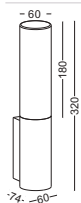

surface customizable

-  white paint similar to RAL9003
-  concrete grey paint similar to RAL7037

code **LWA211**

casing aluminum / black painting

lamping COB 6W / Ra>90 / 430LM

Beam acrylic diffuser

2700K/3000K/4000K/6000K

installation     IP65

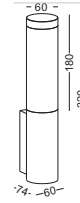

surface customizable

-  white paint similar to RAL9003
-  concrete grey paint similar to RAL7037

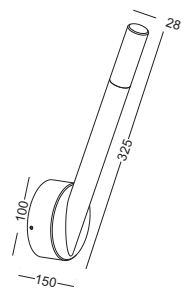

code **LWA135**  
casing aluminum / black painting  
lamping LED 3W / Ra>80 / 120LM  
Beam acrylic diffuser  
2700K/**3000K**/4000K/6000K  
installation     IP65

surface customizable  
 white paint similar to RAL9003  
 concrete grey paint similar to RAL7037

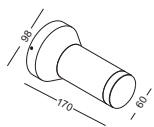

code **LWA139**

casing aluminum / black painting

lamping LED 4W / Ra>80 / 400LM

Beam acrylic diffuser

2700K/3000K/4000K/6000K

installation     IP65

surface  
customizable

 white paint  
similar to RAL9003

 concrete grey paint  
similar to RAL7037





code LWA310  
casing aluminum / black painting  
lamping COB 5W / Ra>90 / 430LM  
Beam acrylic diffuser  
2700K/3000K/4000K/6000K  
installation     IP65

surface customizable  white paint similar to RAL9003  
 concrete grey paint similar to RAL7037

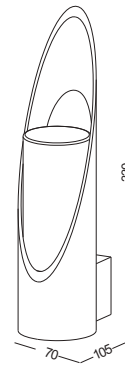

code **LWA311**  
 casing aluminum / black painting  
 lamping COB 5W / Ra>90 / 430LM  
 Beam acrylic diffuser  
 2700K/3000K/4000K/6000K  
 installation IP65

surface customizable

- white paint similar to RAL9003
- concrete grey paint similar to RAL7037

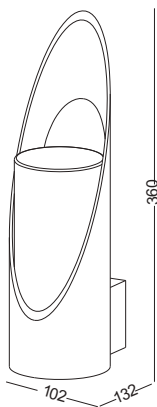



code **LWA312**  
 casing aluminum / black painting  
 lamping COB 5W / Ra>90 / 430LM  
 Beam acrylic diffuser  
 2700K/3000K/4000K/6000K  
 installation IP65

surface customizable

- white paint similar to RAL9003
- concrete grey paint similar to RAL7037





code LWA291A  
casing aluminum / black painting  
lamping COB 2x6W / Ra>90 / 860LM  
Beam acrylic diffuser  
2700K/3000K/4000K/6000K  
installation     IP65

surface customizable  white paint similar to RAL9003  
 concrete grey paint similar to RAL7037

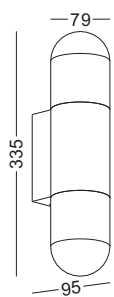

code **LWA292A**  
 casing aluminum / black painting  
 lamping COB 2x6W / Ra>90 / 860LM  
 Beam acrylic diffuser  
 2700K/3000K/4000K/6000K  
 installation IP65

surface customizable white paint similar to RAL9003  
 concrete grey paint similar to RAL7037

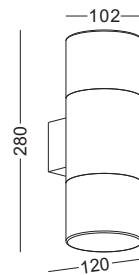



code **LWA293A**  
 casing aluminum / black painting  
 lamping COB 2x9W / Ra>90 / 1600LM  
 Beam acrylic diffuser  
 2700K/3000K/4000K/6000K  
 installation IP65

surface customizable white paint similar to RAL9003  
 concrete grey paint similar to RAL7037



code LWA300C-BK  
casing aluminum / black painting  
lamping LED 4X3W / Ra>80 / 1200LM  
Beam 8 degree /  
2700K/3000K/4000K/6000K  
installation     IP65

surface customizable

	white paint similar to RAL9003
	concrete grey paint similar to RAL7037

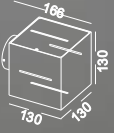

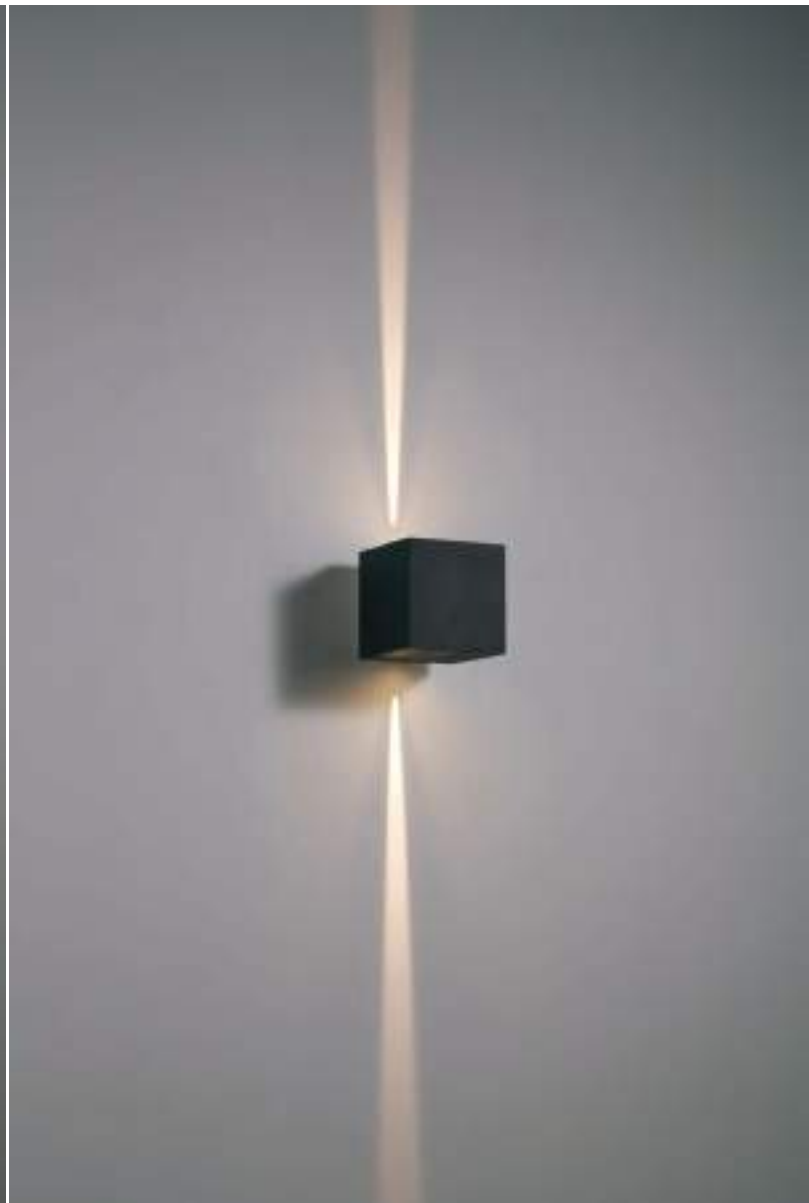

code **LWA300A-BK**  
 casing aluminum / black painting  
 lamping LED 3W / Ra>80 / 300LM  
 Beam 8 degree /  
 2700K/~~3000K~~/4000K/6000K  
 installation     IP65

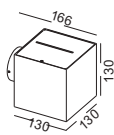

surface customizable  
 white paint similar to RAL9003  
 concrete grey paint similar to RAL7037

code **LWA300B-BK**  
 casing aluminum / black painting  
 lamping LED 2X3W / Ra>80 / 600LM  
 Beam 8 degree /  
 2700K/~~3000K~~/4000K/6000K  
 installation     IP65

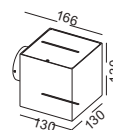

surface customizable  
 white paint similar to RAL9003  
 concrete grey paint similar to RAL7037



LWA300D-BK

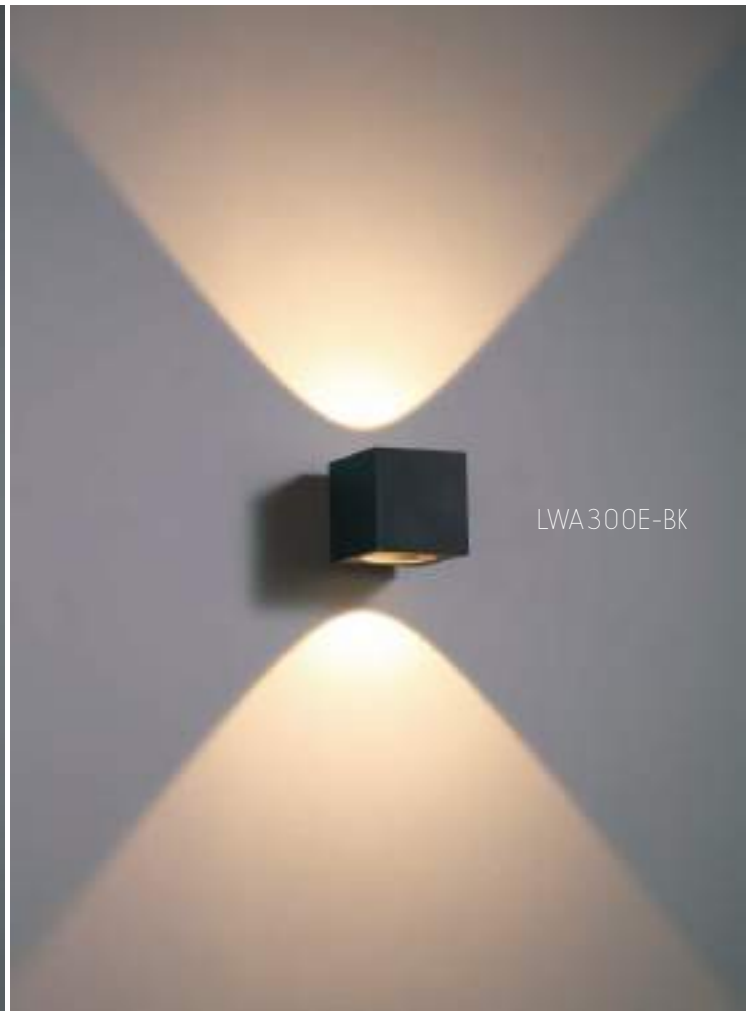

LWA300E-BK



LWA300F-BK



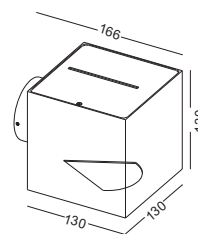
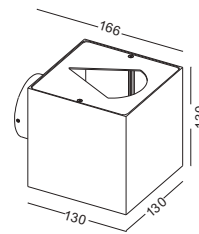
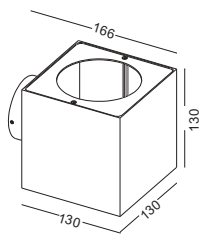
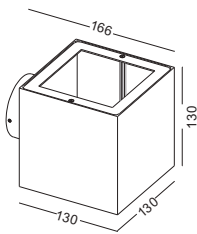

LWA300H-BK



code **LWA300D-BK**

surface customizable  white paint similar to RAL9003  concrete grey paint similar to RAL7037



casing aluminum / black painting / lamping COB 2X3W / Ra>90 / 500LM / up 80 degree+down 80 degree / 2700K/**3000K**/4000K/6000K

installation    IP65 up and down cover sheet can be laser cut to other drawings or shape to get different light shape

code **LWA300E-BK**

surface customizable  white paint similar to RAL9003  concrete grey paint similar to RAL7037

casing aluminum / black painting / lamping COB 2X3W / Ra>90 / 500LM / up 90 degree+down 90 degree / 2700K/**3000K**/4000K/6000K

installation    IP65 up and down cover sheet can be laser cut to other drawings or shape to get different light shape

code **LWA300F-BK**

surface customizable  white paint similar to RAL9003  concrete grey paint similar to RAL7037

casing aluminum / black painting / lamping COB 2X3W / Ra>90 / 500LM / up 60 degree+down 60 degree / 2700K/**3000K**/4000K/6000K

installation    IP65 up and down cover sheet can be laser cut to other drawings or shape to get different light shape

code **LWA300H-BK**

surface customizable  white paint similar to RAL9003  concrete grey paint similar to RAL7037

casing aluminum / black painting / lamping COB 2X3W / Ra>90 / 500LM / up 60 degree+down 8 degree / 2700K/**3000K**/4000K/6000K

installation    IP65 up and down cover sheet can be laser cut to other drawings or shape to get different light shape



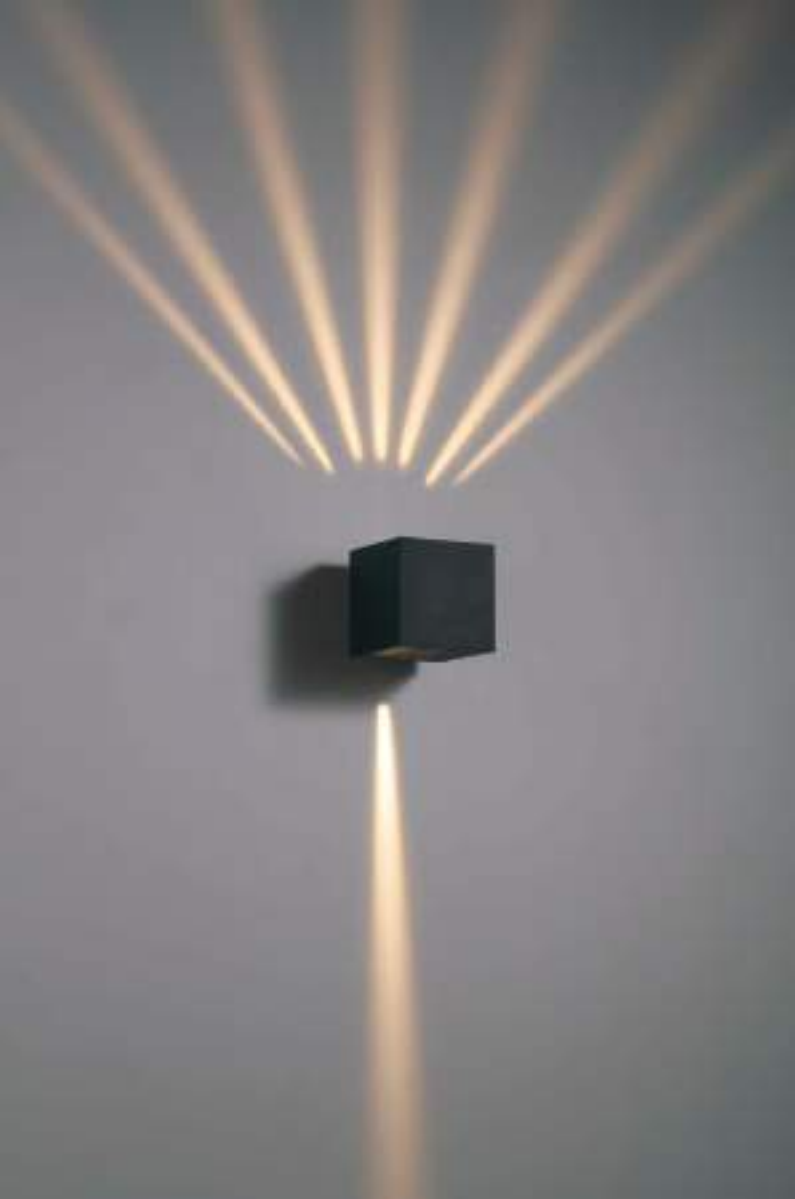

code **LWA300J-BK**  
 casing aluminum / black painting  
 lamping COB 2X3W / Ra>90 / 500LM  
 Beam down 8 degree /  
 2700K/~~3000K~~/4000K/6000K  
 installation     IP65



code **LWA300G-BK**  
 casing aluminum / black painting  
 lamping COB 2X3W / Ra>90 / 500LM  
 Beam dismissed light /  
 2700K/~~3000K~~/4000K/6000K  
 installation     IP65



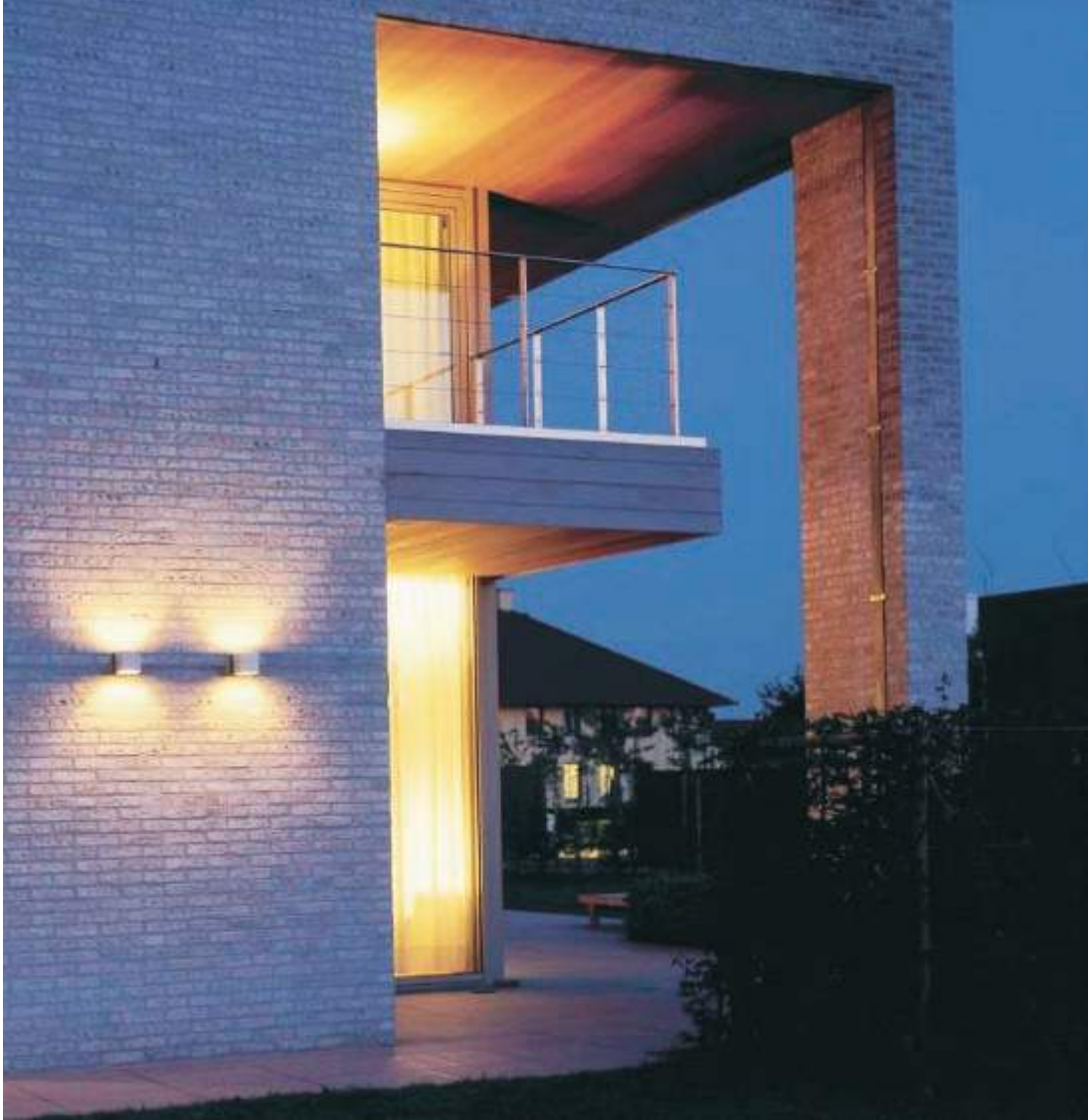





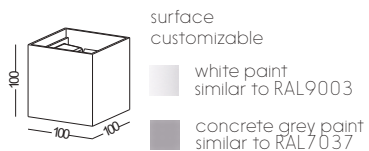

code **LWA288-BK**  
 casing aluminum / black painting  
 lamping LED 2X3W / Ra>80 /600LM  
 Beam up and down light can be adjusted from 5 degree to 120 degree / 2700K/~~3000K~~/4000K/6000K  
 installation     IP65

up and down light cover sheet adjustable



code **LWA288-WT**  
 casing aluminum / white painting  
 lamping LED 2X3W / Ra>80 /600LM  
 Beam up and down light can be adjusted from 5 degree to 120 degree / 2700K/~~3000K~~/4000K/6000K  
 installation     IP65

up and down light cover sheet adjustable

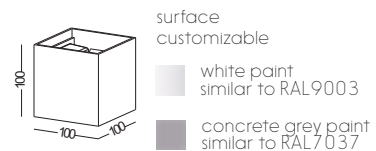





code **LWA279**  
 casing aluminum / black painting  
 lamping LED 3W / Ra>80 / 120LM  
 Beam down 8 degree /  
 2700K/**3000K**/4000K/6000K  
 installation     IP65

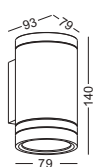

surface customizable



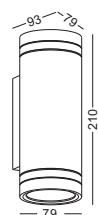

-  white paint similar to RAL9003
-  concrete grey paint similar to RAL7037

code **LWA280**  
 casing aluminum / black painting  
 lamping LED 2X3W / Ra>80 / 240LM  
 Beam up and down 8 degree /  
 2700K/**3000K**/4000K/6000K  
 installation     IP65



surface customizable

-  white paint similar to RAL9003
-  concrete grey paint similar to RAL7037

code **LWA281**  
 casing aluminum / black painting  
 lamping up 3W/ down 6W / Ra>80 / 670LM  
 Beam up 8 degree and down 38 degree  
 2700K/**3000K**/4000K/6000K  
 installation     IP65

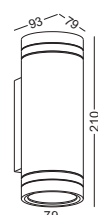

surface customizable

-  white paint similar to RAL9003
-  concrete grey paint similar to RAL7037







ODL007



ODL008



ODL009



ODL010

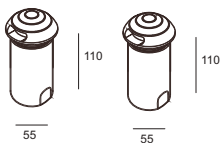

code **ODL007 / ODL008**

casing aluminum / anodized silver / lamping LED 3W / Ra>80 / 120LM / Acrylic diffuser / 2700K/3000K/4000K/6000K red / green / blue

installation    IP65  cut-off dia50x120mm for installation box

surface customizable  concrete grey paint similar to RAL7037  anodized black sandblasted

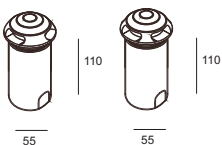

code **ODL009 / ODL010**

casing aluminum / anodized silver / lamping LED 3W / Ra>80 / 120LM / Acrylic diffuser / 2700K/3000K/4000K/6000K red / green / blue

installation    IP65  cut-off dia50x120mm for installation box

surface customizable  concrete grey paint similar to RAL7037  anodized black sandblasted



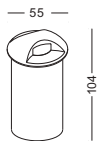

code **ODL025**

surface customizable  concrete grey paint similar to RAL7037  anodized black sandblasted

casing aluminum / anodized silver / lamping LED 3W / Ra>80 / 120LM / two ways light / 2700K/**3000K**/4000K/6000K red / green / blue

installation **CE IP67** cut-off dia50x100mm for installation box

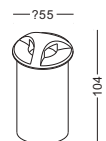

code **ODL026**

surface customizable  concrete grey paint similar to RAL7037  anodized black sandblasted

casing aluminum / anodized silver / lamping LED 3W / Ra>80 / 120LM / three ways light / 2700K/**3000K**/4000K/6000K red / green / blue

installation **CE IP67** cut-off dia50x100mm for installation box

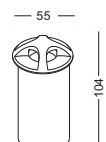

code **ODL027**

surface customizable  concrete grey paint similar to RAL7037  anodized black sandblasted

casing aluminum / anodized silver / lamping LED 3W / Ra>80 / 120LM / four ways light / 2700K/**3000K**/4000K/6000K red / green / blue

installation **CE IP67** cut-off dia50x100mm for installation box



code **ODL043**  
 casing aluminum / anodized black  
 lamping LED 1W / Ra>80 / 70LM  
 Beam acrylic diffuser  
 2700K/3000K/4000K/6000K  
 red / green / blue  
 installation   **CE IP65**

 cut-off dia55x100mm  
 for installation box

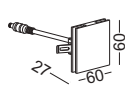

surface  
 customizable  
 white paint  
 similar to RAL9003  
 concrete grey paint  
 similar to RAL7037

code **ODL044**  
 casing aluminum / anodized black  
 lamping LED 1W / Ra>80 / 70LM  
 Beam acrylic diffuser  
 2700K/3000K/4000K/6000K  
 red / green / blue  
 installation   **CE IP65**

 cut-off dia55x100mm  
 for installation box



surface  
 customizable  
 white paint  
 similar to RAL9003  
 concrete grey paint  
 similar to RAL7037

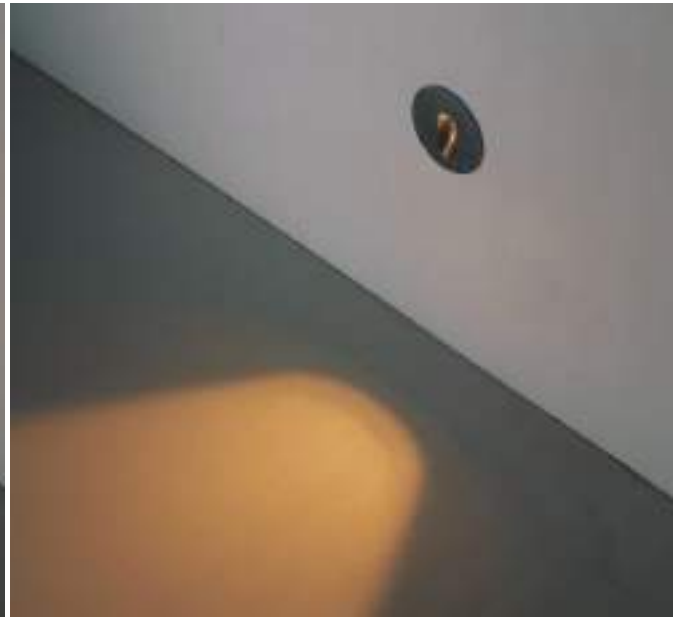
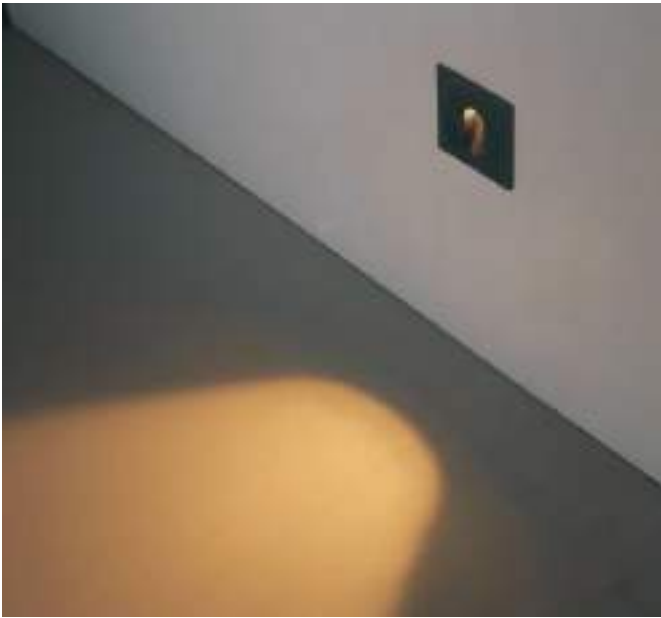

code **ODL041**  
 casing aluminum / anodized black  
 lamping LED 1W / Ra>80 / 70LM  
 Beam acrylic diffuser  
 2700K/3000K/4000K/6000K  
 red / green / blue  
 installation   **IP65**

 cut-off dia55x100mm  
 for installation box

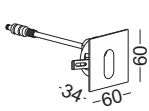

surface  
 customizable  
 white paint  
 similar to RAL9003  
 concrete grey paint  
 similar to RAL7037

code **ODL042**  
 casing aluminum / anodized black  
 lamping LED 1W / Ra>80 / 70LM  
 Beam acrylic diffuser  
 2700K/3000K/4000K/6000K  
 red / green / blue  
 installation   **IP65**

 cut-off dia55x100mm  
 for installation box

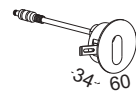

surface  
 customizable  
 white paint  
 similar to RAL9003  
 concrete grey paint  
 similar to RAL7037

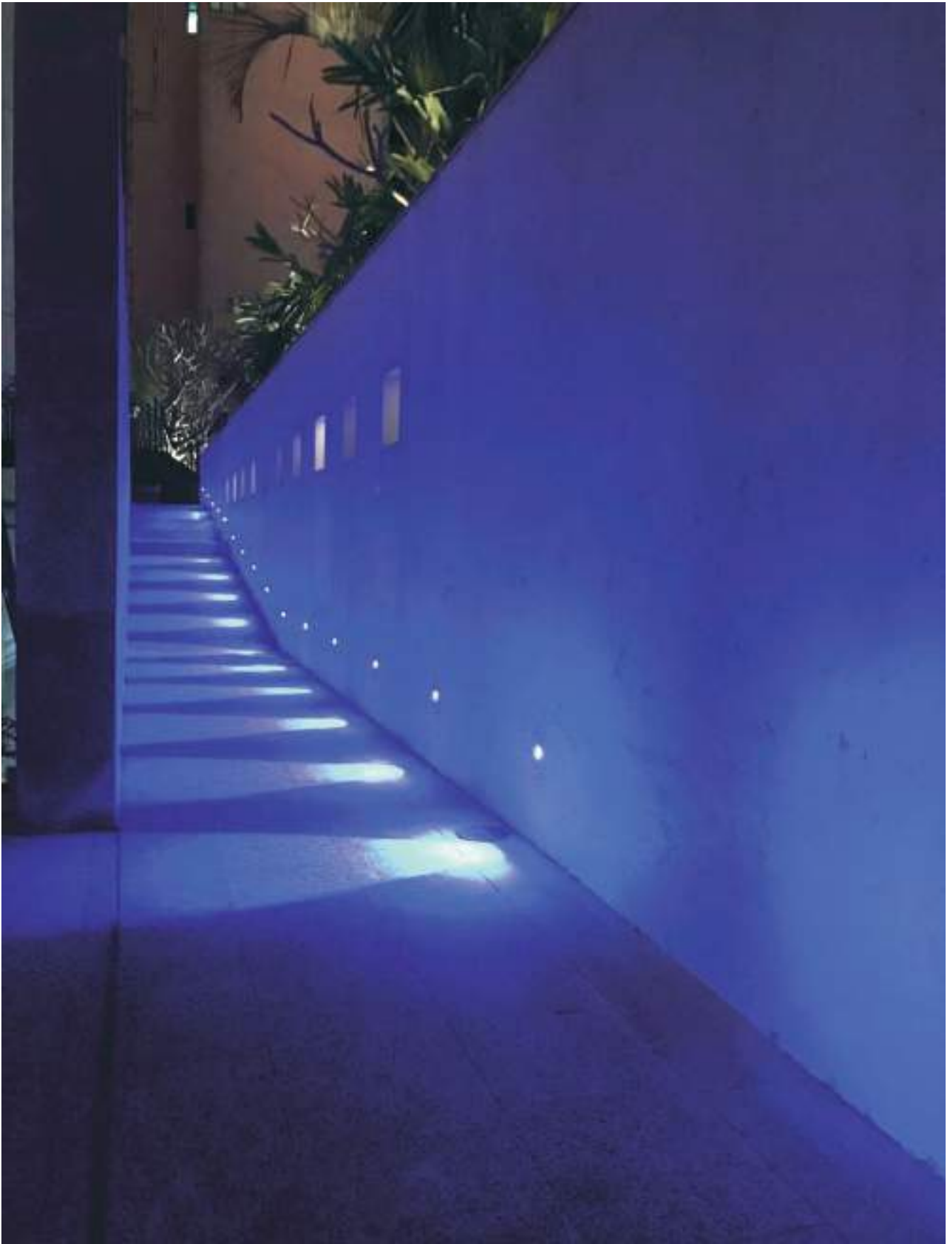

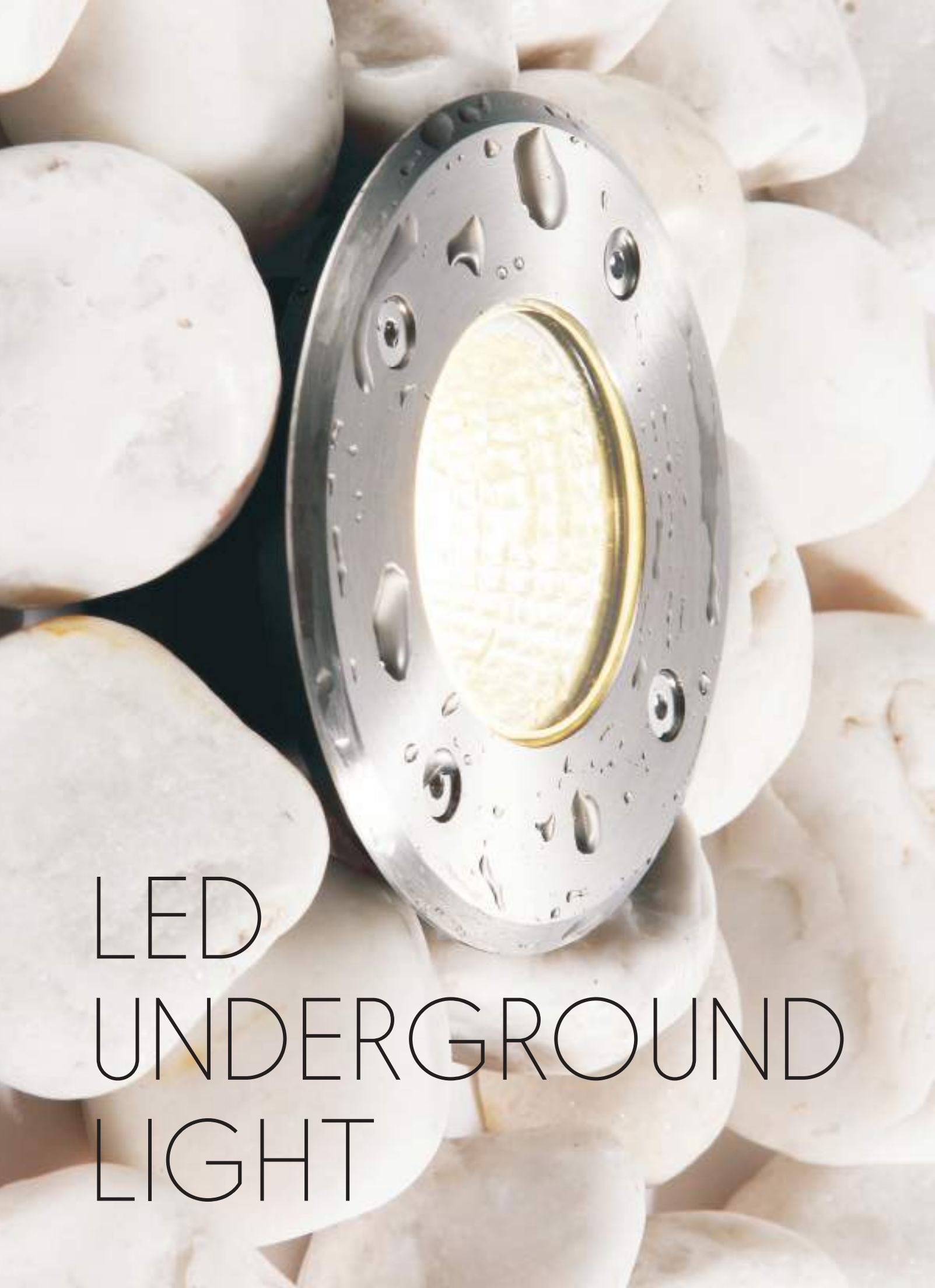

LED  
UNDERGROUND  
LIGHT

# 12V / 24V / 220V INPUT UNDERGROUND SPOT LIGHT

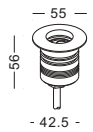

code **ODL031** Stainless steel 316 cover / aluminum heat sink / aluminum installation case  
 casing aluminum+stainless steel / lamping LED 3W / Ra>80 / 210LM / Beam 15/30/60 degree / 2700K/3000K/4000K/6000K red / green / blue  
 installation **CE IP67** supplied with external 100-240V input Ip67 LED driver /check installation in next page



code **ODL032** Stainless steel 316 cover / aluminum heat sink / aluminum installation case  
 casing aluminum+stainless steel / lamping LED 6W / Ra>80 / 420LM / Beam 15/30/60 degree / 2700K/3000K/4000K/6000K red / green / blue  
 installation **CE IP67** supplied with external 100-240V input Ip67 LED driver /check installation in next page

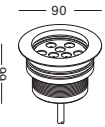

code **ODL033** Stainless steel 316 cover / aluminum heat sink / aluminum installation case  
 casing aluminum+stainless steel / lamping LED 9W / Ra>80 / 630LM / Beam 15/30/60 degree / 2700K/3000K/4000K/6000K red / green / blue  
 installation **CE IP67** supplied with external 100-240V input Ip67 LED driver /check installation in next page

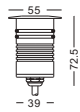

code **ODL031-IN12** Stainless steel 316 cover / aluminum heat sink / aluminum installation case  
 casing aluminum+stainless steel / lamping LED 3W / Ra>80 / 210LM / Beam 15/30/60 degree / 2700K/3000K/4000K/6000K red / green / blue  
 installation **CE IP67** supplied with built-in DC 12/24V input LED driver /check installation in next page

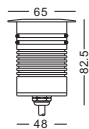

code **ODL032-IN12** Stainless steel 316 cover / aluminum heat sink / aluminum installation case  
 casing aluminum+stainless steel / lamping LED 6W / Ra>80 / 420LM / Beam 15/30/60 degree / 2700K/3000K/4000K/6000K red / green / blue  
 installation **CE IP67** supplied with built-in DC 12/24V input LED driver /check installation in next page

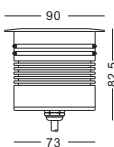

code **ODL033-IN12** Stainless steel 316 cover / aluminum heat sink / aluminum installation case  
 casing aluminum+stainless steel / lamping LED 9W / Ra>80 / 630LM / Beam 15/30/60 degree / 2700K/3000K/4000K/6000K red / green / blue  
 installation **CE IP67** supplied with built-in DC 12/24V input LED driver /check installation in next page

# ODL031 installation

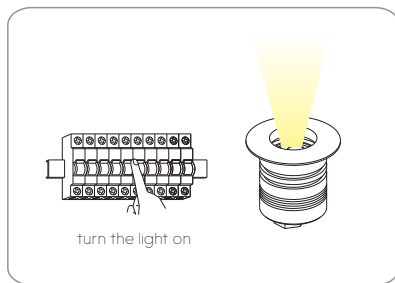
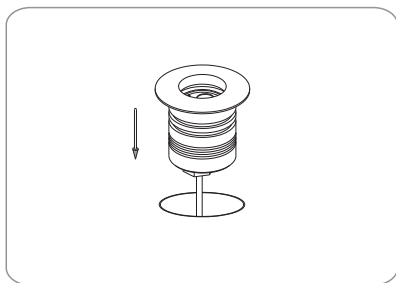
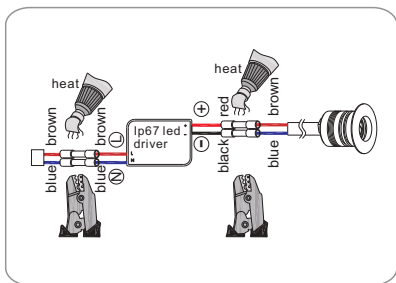
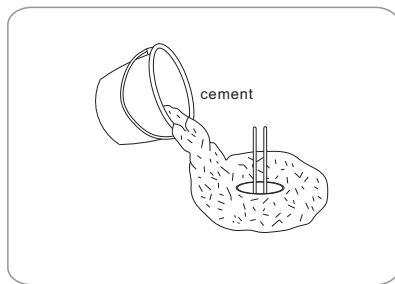
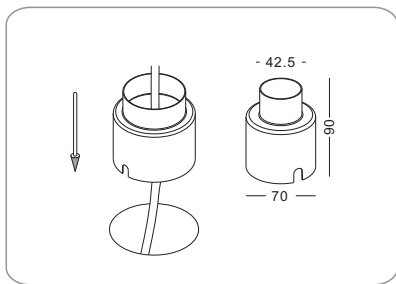
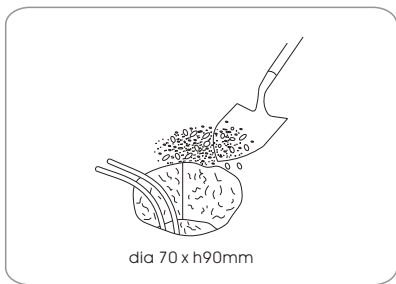

# ODL032 / ODL033 installation

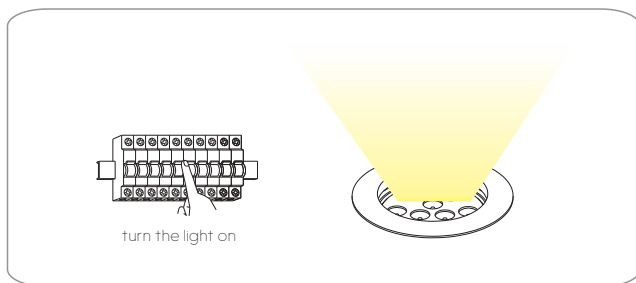
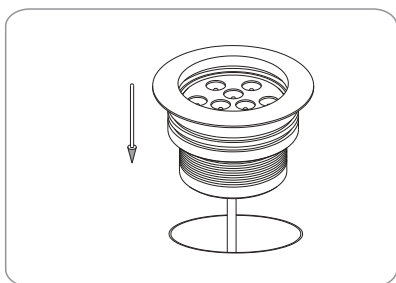
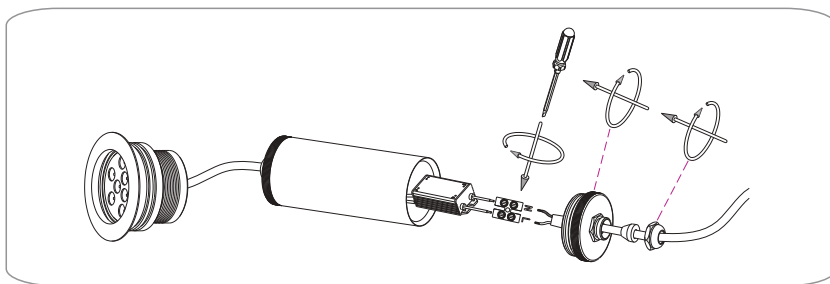
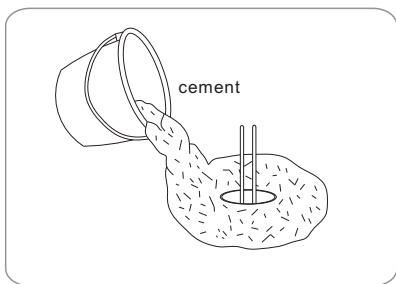
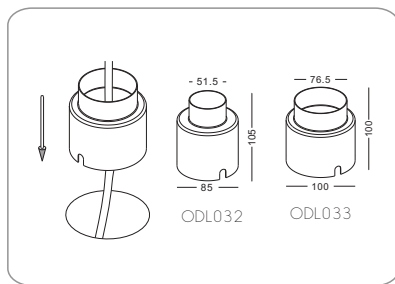
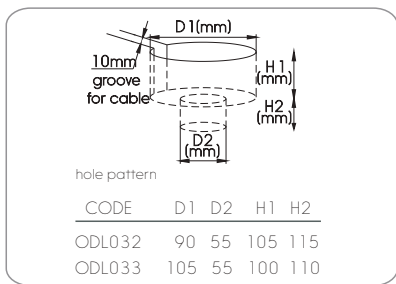
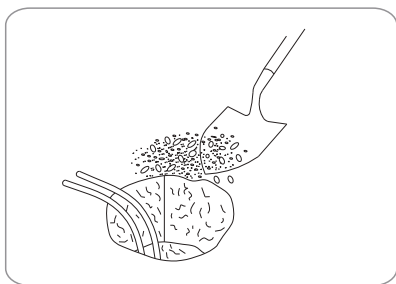

ODL031-IN12 / ODL032-IN12 / ODL033-IN12 installation



CODE	Diameter	Depth
ODL031-IN12	75mm	90mm
ODL032-IN12	90mm	105mm
ODL032-IN12	105mm	100mm

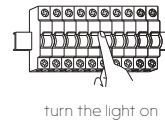
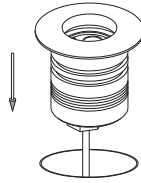
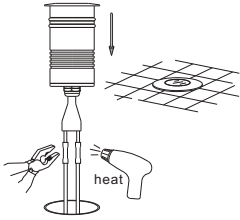
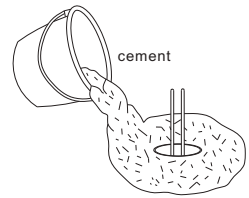
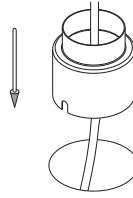

Lamp in a parallel circuit

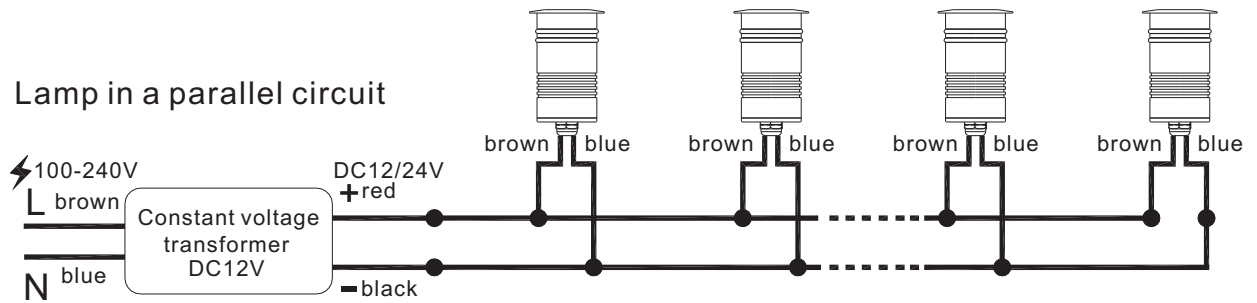

DO NOT CONNECT THE LAMP WHEN THERE IS CIRCUIT IN CASE LED CHIP DAMAGED



DO NOT CONNECT THE LAMP DIRECTLY TO THE MAIN







OUTDOOR UNDERGROUND IP67 WATERPROOF  
 MINI LED SPOTLIGHT 220V / DC 12/24V  
 STAINLESS STEEL 316 COVER INPUT OPTIONAL  
 COPPER LAMP CASING SUPPLIED WITH  
 CHROME PLATED INSTALLATION CASE  
 1W / 3W LED AND EXTERNAL  
 10/20/30/45/60 OR BUILT-IN  
 DEGREE LENS POWER-SUPPLY

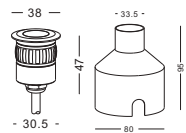

code **ODL020**

stainless steel 316 cover / brass heat sink / aluminum installation case

casing stainless steel+brass/ lamping LED 1W / Ra>80 / 70LM / Beam 10/20/30 degree / 2700K/3000K/4000K/6000K red / green / blue /

installation **CE IP67** supplied with external 100-240V input Ip67 LED driver /check installation in next page

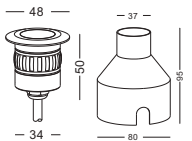

code **ODL024**

stainless steel 316 cover / brass heat sink / aluminum installation case

casing stainless steel+brass/ lamping LED 3W / Ra>80 / 120LM / Beam 15/30/45/60 degree / 2700K/3000K/4000K/6000K/red / green / blue

installation **CE IP67** supplied with external 100-240V input Ip67 LED driver /check installation in next page

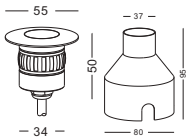

code **ODL001**

aluminum cover / aluminum heat sink / aluminum installation case

casing aluminum / lamping LED 3W / Ra>80 / 120LM / Beam 15/30/45/60 degree / 2700K/3000K/4000K/6000K red / green / blue / RGB

installation **CE IP67** supplied with external 100-240V input Ip67 LED driver /check installation in next page

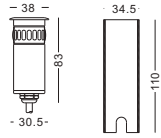

code **ODL020-IN12**

stainless steel 316 cover / aluminum heat sink / aluminum installation case

casing stainless steel+aluminum / lamping LED 1W / Ra>80 / 70LM / Beam 10/20/30 degree / 2700K/3000K/4000K/6000K/red / green / blue

installation    **CE IP67** supplied with built-in DC 12/24V input LED driver /check installation in next page

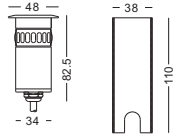

code **ODL024-IN12**

stainless steel 316 cover / brass heat sink / aluminum installation case

casing stainless steel+aluminum / lamping LED 3W / Ra>80 / 120LM / Beam 15/30/45/60 degree / 2700K/3000K/4000K/6000K/red / green / blue

installation    **CE IP67** supplied with built-in DC 12/24V input LED driver /check installation in next page

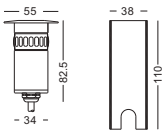

code **ODL001-IN12**

aluminum cover / aluminum heat sink / aluminum installation case

casing aluminum / lamping LED 3W / Ra>80 / 120LM / Beam 15/30/45/60 degree / 2700K/3000K/4000K/6000K/red / green / blue / RGB

installation    **CE IP67** supplied with built-in DC 12/24V input LED driver /check installation in next page



# ODL020 / ODL024 / ODL001 installation

## ODL020 / ODL024 / ODL001 Single lamp installation

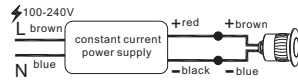

300mA 1x1W for ODL020  
600mA 1x3W for ODL024/ODL001

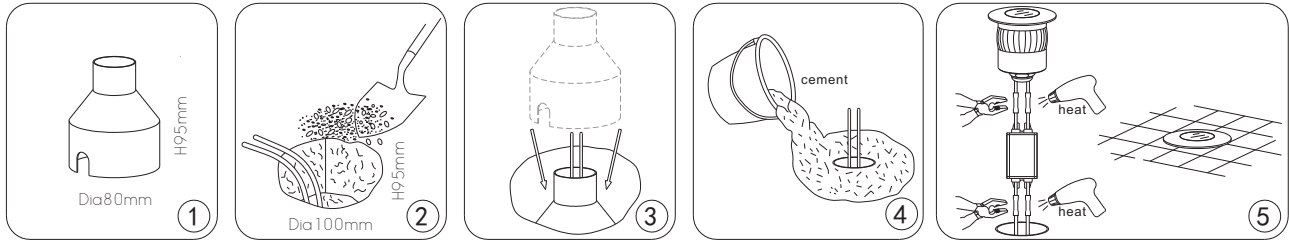

## ODL024 / ODL001 Installation in series

### lamps in a series circuit

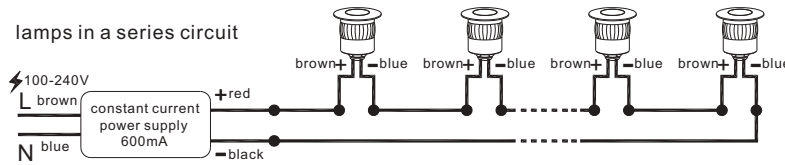

Constant current power supply			
Power supply	Out put current	Out put voltage	Load
2-3x 3W	600mA	DC5-12V	2-3pcs
4-6x 3W	600mA	DC12-22V	4-6pcs
6-10x 3W	600mA	DC20-36V	6-10pcs
10-14x 3W	600mA	DC30-50V	10-14pcs

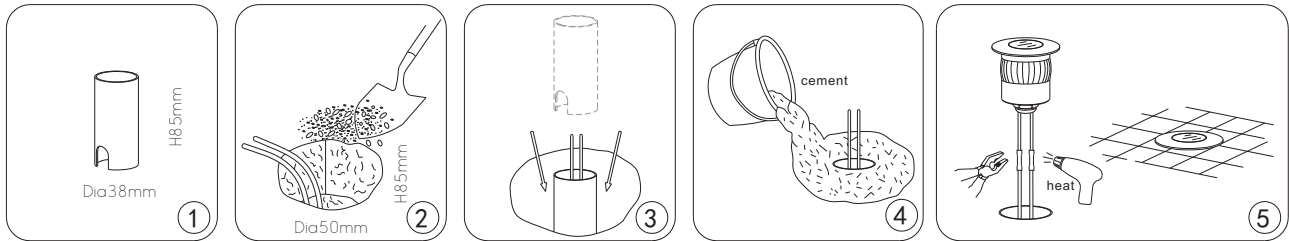

## ODL020 Installation in series

### lamps in a series circuit

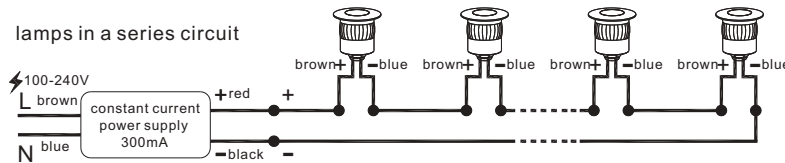

Constant current power supply			
Power supply	Out put current	Out put voltage	Load
1-3x1W	300mA	DC3-11V	1-3pcs
4-7x1W	300mA	DC12-25V	4-7pcs
7-12x1W	300mA	DC20-43V	7-12pcs
12-20x1W	300mA	DC36-72V	12-20pcs
18-28x1W	300mA	DC50-100V	18-28pcs

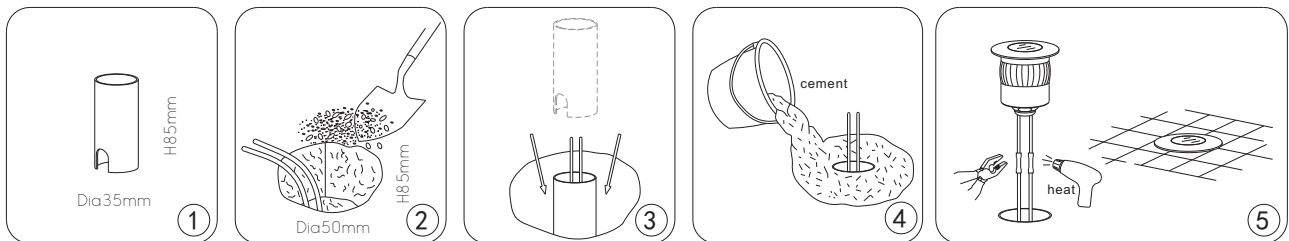

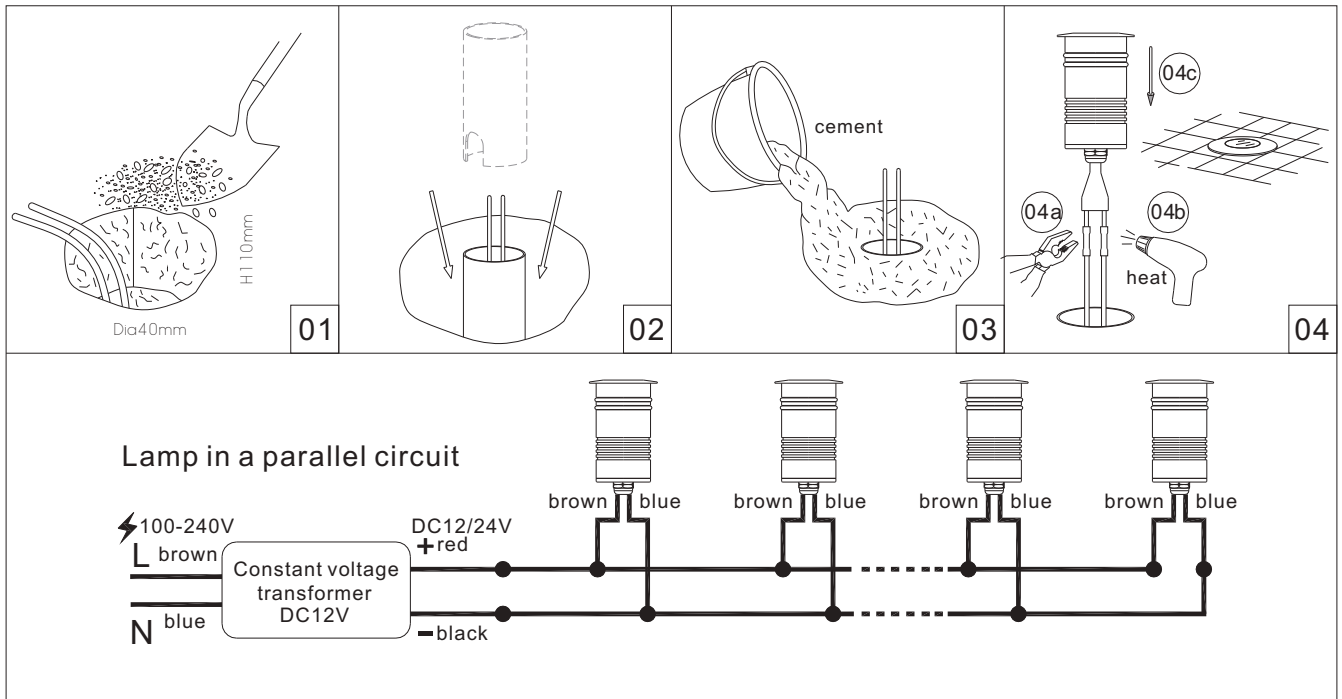

DO NOT CONNECT THE LAMP DIRECTLY TO THE MAIN

# STAINLESS STEEL HIGH POWER LED UNDERGROUND SPOT LIGHT

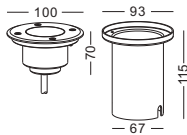

code **ODL028** Stainless steel 316 cover / aluminum heat sink / aluminum installation case  
 casing stainless steel+ / lamping COB 5W / Ra>90 /430LM / Beam 15/24/38/60 degree / 2700K/3000K/4000K/6000K  
 aluminum  
 installation **IP67** supplied with external 100-240V input Ip67 LED driver /check installation in next page

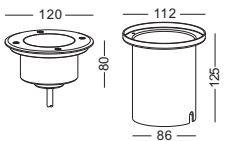

code **ODL029** Stainless steel 316 cover / aluminum heat sink / aluminum installation case  
 casing stainless steel+ / lamping COB 9W / Ra>90 /800LM / Beam 15/24/38/60 degree / 2700K/3000K/4000K/6000K  
 aluminum  
 installation **IP67** supplied with external 100-240V input Ip67 LED driver /check installation in next page

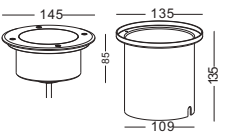

code **ODL030** Stainless steel 316 cover / aluminum heat sink / aluminum installation case  
 casing stainless steel+ / lamping COB 12W / Ra>90 /900LM / Beam 15/24/38/60 degree / 2700K/3000K/4000K/6000K  
 aluminum  
 installation **IP67** supplied with external 100-240V input Ip67 LED driver /check installation in next page

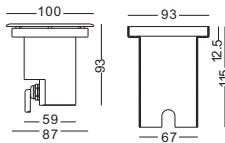

code **ODL028-IN12** Stainless steel 316 cover / aluminum heat sink / aluminum installation case  
 casing stainless steel+ / lamping COB 5W / Ra>90 /430LM / Beam 15/24/38/60 degree / 2700K/3000K/4000K/6000K  
 aluminum  
 installation **IP67** supplied with built-in DC 12/24V input LED driver /check installation in next page

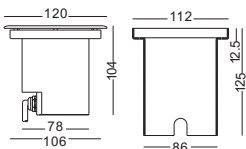

code **ODL029-IN12** Stainless steel 316 cover / aluminum heat sink / aluminum installation case  
 casing stainless steel+ / lamping COB 9W / Ra>90 /800LM / Beam 15/24/38/60 degree / 2700K/3000K/4000K/6000K  
 aluminum  
 installation **IP67** supplied with built-in DC 12/24V input LED driver /check installation in next page

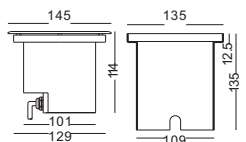

code **ODL030-IN12** Stainless steel 316 cover / aluminum heat sink / aluminum installation case  
 casing stainless steel+ / lamping COB 12W / Ra>90 /900LM / Beam 15/24/38/60 degree / 2700K/3000K/4000K/6000K  
 aluminum  
 installation **IP67** supplied with built-in DC 12/24V input LED driver /check installation in next page

ODL028 / ODL029 / ODL030 installation

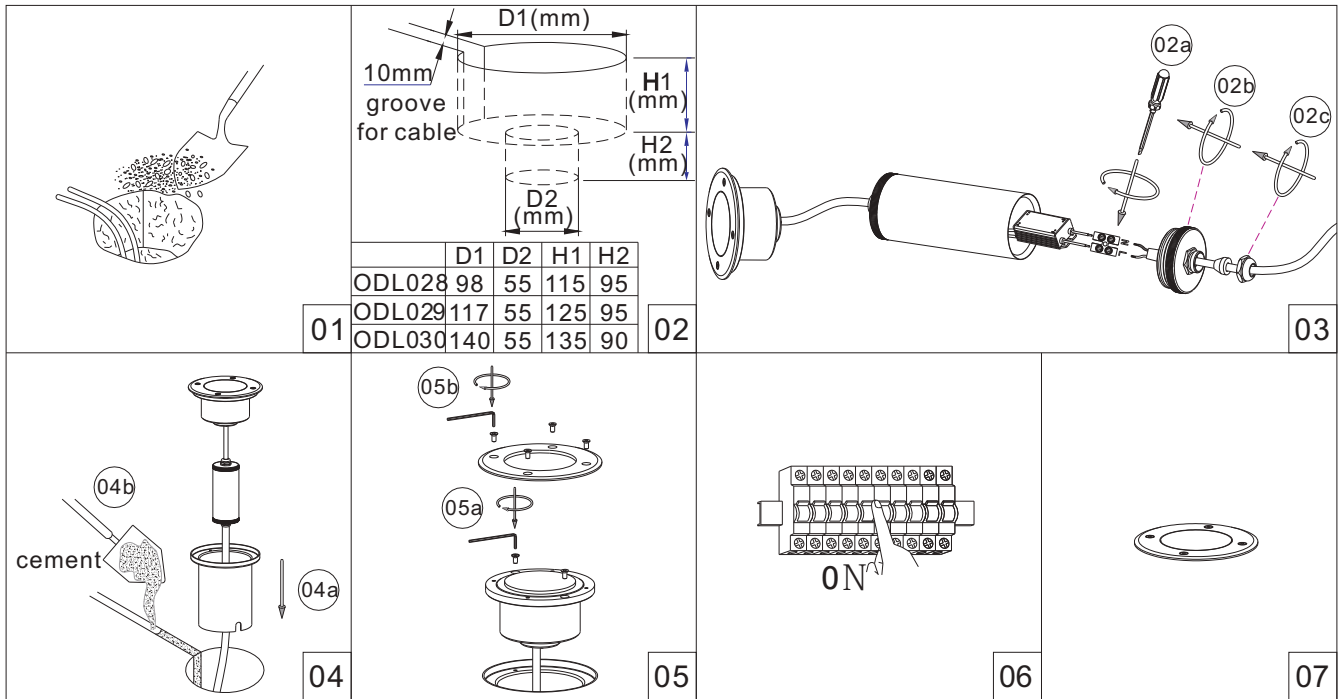

ODL028-IN12 / ODL029-IN12 / ODL030-IN12 installation

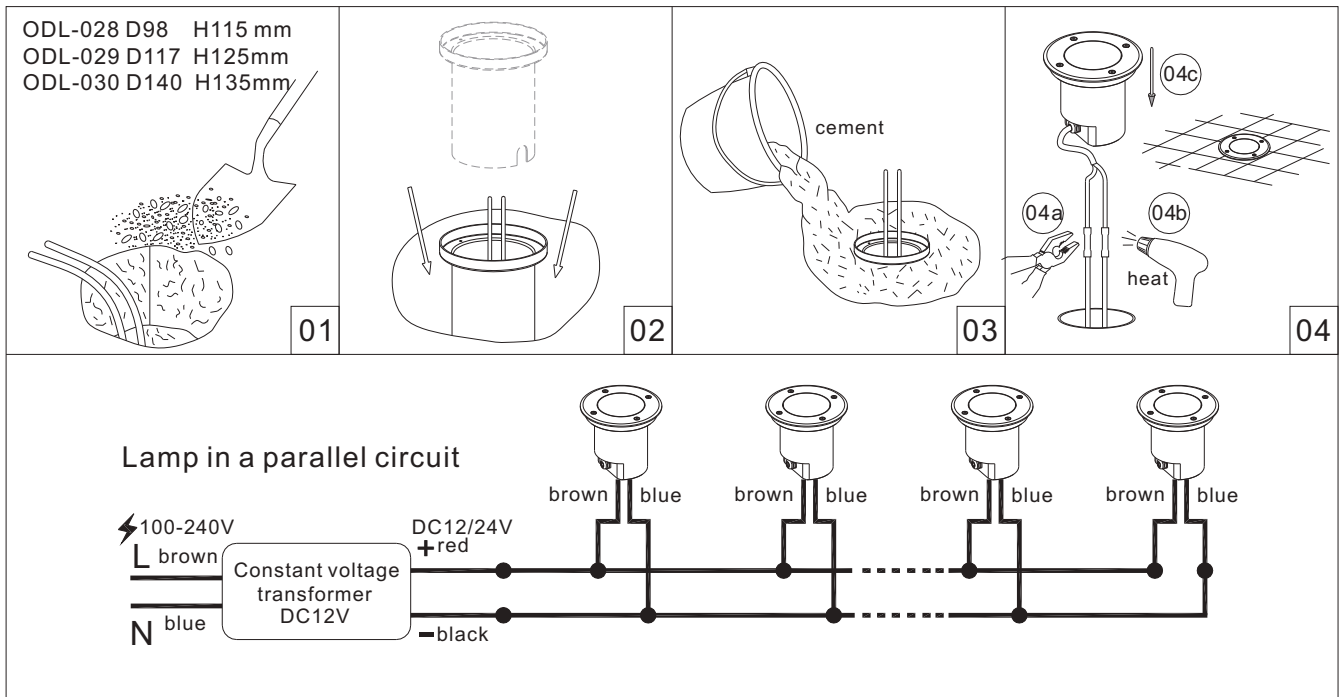

DO NOT CONNECT THE LAMP DIRECTLY TO THE MAIN







## OUTDOOR SPOT LIGHT WITH SPIKE

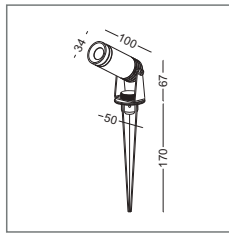

surface  
customizable

■ concrete grey paint  
similar to RAL7037

code **LSP183-IN220**  
 casing aluminum  
 finishing black painting  
 lamping LED 3W  
 Lumens 120LM  
 CRI Ra>80  
 Beam 10/20/30 degree  
 led color 2700K/3000K/4000K/6000K  
 RED / GREEN / BLUE  
 Input AC220-240V  
 built-in power-supply  
 installation   **CE IP65**

code **LSP183-IN12**  
 Input DC12/24V  
 built-in power-supply  
 installation in parallel

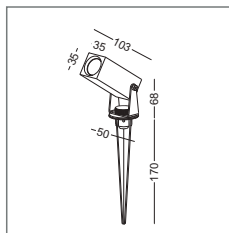

surface  
customizable

■ concrete grey paint  
similar to RAL7037

code **LSP187-IN220**  
 casing aluminum  
 finishing black painting  
 lamping LED 3W  
 Lumens 120LM  
 CRI Ra>80  
 Beam 10/20/30 degree  
 led color 2700K/3000K/4000K/6000K  
 RED / GREEN / BLUE  
 Input AC220-240V  
 built-in power-supply  
 installation   **CE IP65**

code **LSP187-IN12**  
 Input DC12/24V  
 built-in power-supply  
 installation in parallel



## OUTDOOR SPOT LIGHT WITH SPIKE

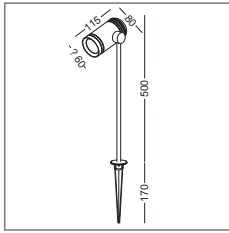

surface  
customizable

■ concrete grey paint  
similar to RAL7037

code **LFL027-IN220**  
casing aluminum  
finishing black painting  
lamping COB 6W  
Lumens 500LM  
CRI Ra>90  
Beam 15/24/**38**/60 degree  
led color 2700K/**3000K**/4000K/6000K  
Input AC220-240V  
built-in power-supply  
installation   **CE** IP65

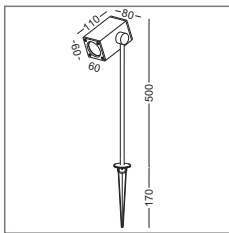

surface  
customizable

■ concrete grey paint  
similar to RAL7037

code **LFL027-IN12**  
Input DC12/24V  
built-in power-supply  
installation in parallel

code **LFL028-IN220**  
casing aluminum  
finishing black painting  
lamping COB 6W  
Lumens 500LM  
CRI Ra>90  
Beam 15/24/**38**/60 degree  
led color 2700K/**3000K**/4000K/6000K  
Input AC220-240V  
built-in power-supply  
installation   **CE** IP65

code **LFL028-IN12**  
Input DC12/24V  
built-in power-supply  
installation in parallel



## OUTDOOR SPOT LIGHT WITH SPIKE

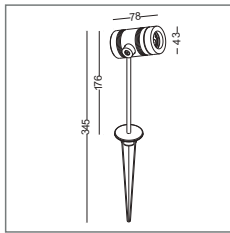

surface  
customizable

■ concrete grey paint  
similar to RAL7037

code **ODL034**  
 casing aluminum  
 finishing black painting  
 lamping LED 3X1W  
 Lumens 210LM  
 CRI Ra>80  
 Beam 15/30/60 degree  
 led color 2700K/3000K/4000K/6000K  
 RED / GREEN / BLUE  
 Input AC220-240V  
 external power-supply  
 installation   IP65

code **ODL034-12V**  
 Input DC 12/24V  
 external power-supply  
 installation in parallel

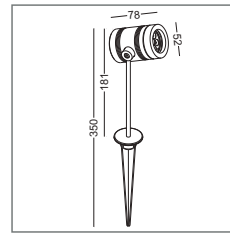

surface  
customizable

■ concrete grey paint  
similar to RAL7037

code **ODL035**  
 casing aluminum  
 finishing black painting  
 lamping LED 6X1W  
 Lumens 420LM  
 CRI Ra>80  
 Beam 15/30/60 degree  
 led color 2700K/3000K/4000K/6000K  
 RED / GREEN / BLUE  
 Input AC220-240V  
 external power-supply  
 installation   IP65

code **ODL035-12V**  
 Input DC 12/24V  
 external power-supply  
 installation in parallel

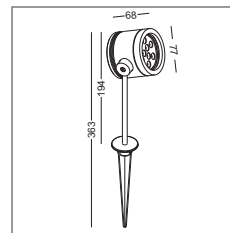

surface  
customizable

■ concrete grey paint  
similar to RAL7037

code **ODL036**  
 casing aluminum  
 finishing black painting  
 lamping LED 9X1W  
 Lumens 630LM  
 CRI Ra>80  
 Beam 15/30/60 degree  
 led color 2700K/3000K/4000K/6000K  
 RED / GREEN / BLUE  
 Input AC220-240V  
 external power-supply  
 installation   IP65

code **ODL036-12V**  
 Input DC 12/24V  
 external power-supply  
 installation in parallel



## OUTDOOR SPOT LIGHT WITH SPIKE

### code LSP155

casing aluminum  
 finishing black painting  
 lamping COB 6W  
 Lumens 500LM  
 CRI Ra>90  
 Beam 15/24/38/60 degree  
 led color 2700K/3000K/4000K/6000K  
 Input AC220-240V  
 external power-supply  
 installation   **CE** IP65

### code LSP155-12V

Input DC12/24V  
 external power-supply  
 installation in parallel

### code LSP156

casing aluminum  
 finishing black painting  
 lamping COB 9W  
 Lumens 800LM  
 CRI Ra>90  
 Beam 15/24/38/60 degree  
 led color 2700K/3000K/4000K/6000K  
 Input AC220-240V  
 external power-supply  
 installation   **CE** IP65

### code LSP156-12V

Input DC12/24V  
 external power-supply  
 installation in parallel

### code LSP157

casing aluminum  
 finishing black painting  
 lamping COB 12W  
 Lumens 900LM  
 CRI Ra>90  
 Beam 15/24/38/60 degree  
 led color 2700K/3000K/4000K/6000K  
 Input AC220-240V  
 external power-supply  
 installation   **CE** IP65

### code LSP157-12V

Input DC12/24V  
 external power-supply  
 installation in parallel

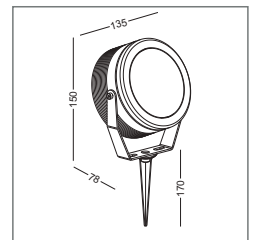
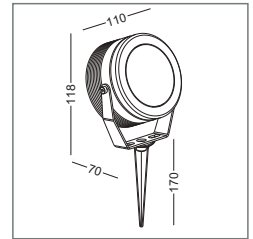
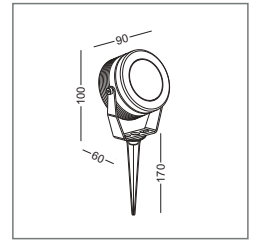

surface customizable  
 concrete grey paint similar to RAL7037



## OUTDOOR SPOT LIGHT WITH SPIKE

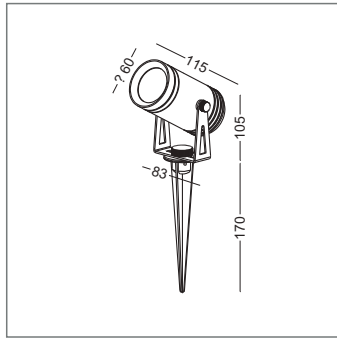

code **LSP184-IN220**  
 casing aluminum  
 finishing black painting  
 lamping COB 6W  
 Lumens 500LM  
 CRI Ra>90  
 Beam 15/24/38/60 degree  
 led color 2700K/3000K/4000K/6000K  
 Input AC220-240V  
 built-in power-supply  
 installation IP65

code **LSP184-IN12**  
 Input DC12/24V  
 built-in power-supply  
 installation in parallel

surface customizable  
 concrete grey paint similar to RAL7037

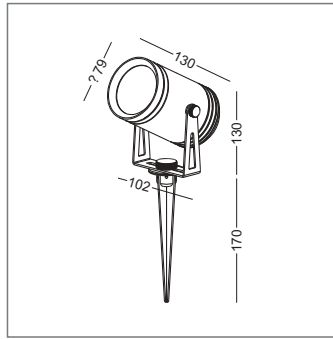

code **LSP185-IN220**  
 casing aluminum  
 finishing black painting  
 lamping COB 9W  
 Lumens 800LM  
 CRI Ra>90  
 Beam 15/24/38/60 degree  
 led color 2700K/3000K/4000K/6000K  
 Input AC220-240V  
 built-in power-supply  
 installation IP65

code **LSP185-IN12**  
 Input DC12/24V  
 built-in power-supply  
 installation in parallel

surface customizable  
 concrete grey paint similar to RAL7037

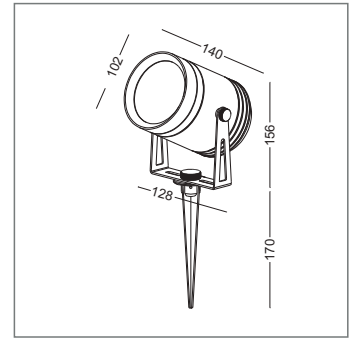

code **LSP186-IN220**  
 casing aluminum  
 finishing black painting  
 lamping COB 12W  
 Lumens 900LM  
 CRI Ra>90  
 Beam 15/24/38/60 degree  
 led color 2700K/3000K/4000K/6000K  
 Input AC220-240V  
 built-in power-supply  
 installation IP65

code **LSP186-IN12**  
 Input DC12/24V  
 built-in power-supply  
 installation in parallel

surface customizable  
 concrete grey paint similar to RAL7037



## OUTDOOR SPOT LIGHT WITH SPIKE

code **LSP188-IN220**

casing aluminum

finishing black painting

lamping COB 6W

Lumens 500LM

CRI Ra>90

Beam 15/24/38/60 degree

led color 2700K/3000K/4000K/6000K

Input AC220-240V

built-in power-supply

installation    IP65

code **LSP188-IN12**

Input DC12/24V

built-in power-supply

installation in parallel

code **LSP189-IN220**

casing aluminum

finishing black painting

lamping COB 12W

Lumens 900LM

CRI Ra>90

Beam 15/24/38/60 degree

led color 2700K/3000K/4000K/6000K

Input AC220-240V

built-in power-supply

installation    IP65

code **LSP189-IN12**

Input DC12/24V

built-in power-supply

installation in parallel

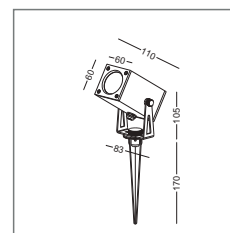

surface customizable

 concrete grey paint similar to RAL7037

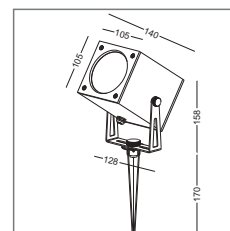

surface customizable

 concrete grey paint similar to RAL7037



# LED GARDEN AND PATH LIGHTS

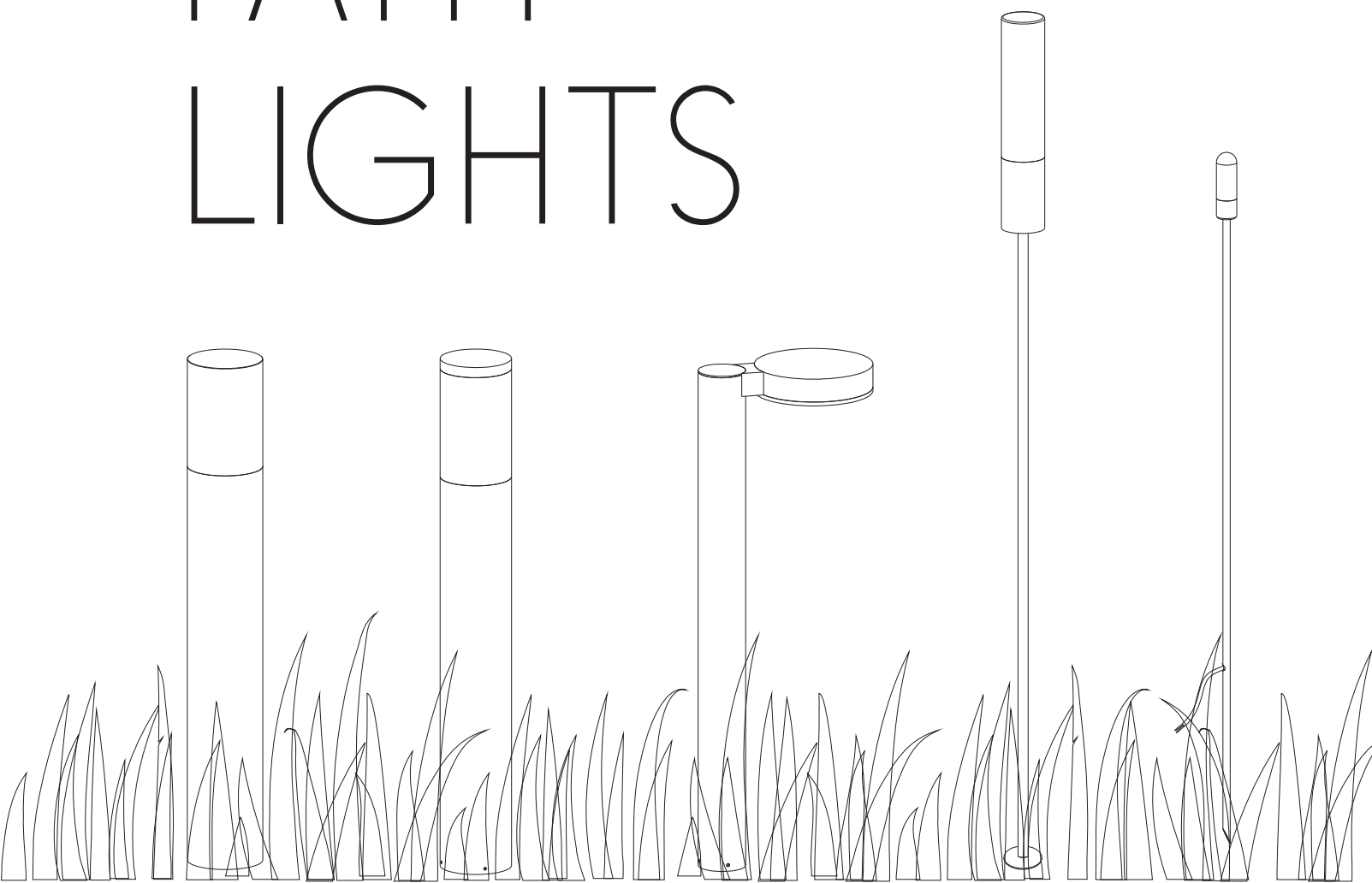

# LED GARDEN AND PATH LIGHTS

code **LFL006**

**LFL007**

**LFL008**

casing aluminum

finishing black painting

lampping COB 6W

Lumens 500LM

CRI Ra>90

Beam Solid acrylic diffuser

led color 2700K/**3000K**/4000K/6000K

Input AC 100-240V

built-in power-supply

installation   **CE** IP65

code **LFL006-IN12**

**LFL007-IN12**

**LFL008-IN12**

Input DC 12/24V

built-in power-supply

installation in parallel

surface customizable

 concrete grey paint similar to RAL7037

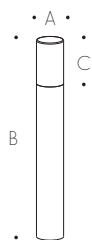
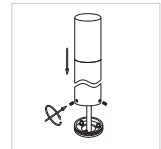
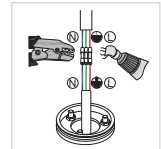
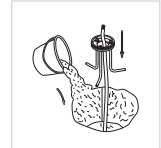
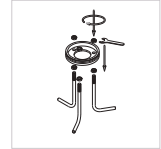

code	A/mm	B/mm	C/mm
LFL006	60	450	100
LFL007	60	650	100
LFL007	60	800	100





# LED GARDEN AND PATH LIGHTS



code **LFL009**  
**LFL010**  
**LFL011**

casing aluminum  
 finishing black painting  
 lamping COB 9W  
 Lumens 800LM  
 CRI Ra>90  
 Beam Solid acrylic diffuser  
 led color 2700K/**3000K**/4000K/6000K  
 Input AC100-240V  
 built-in power-supply  
 installation    IP65

code **LFL009-IN12**  
**LFL010-IN12**  
**LFL011-IN12**

Input DC 12/24V  
 built-in power-supply  
 installation in parallel

surface customizable  
 concrete grey paint similar to RAL7037

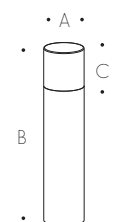
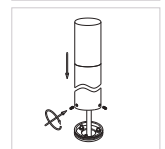
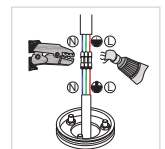
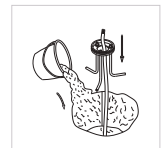
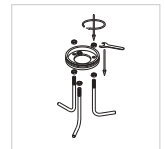

code	A/mm	B/mm	C/mm
LFL009	102	210	60
LFL010	102	410	60
LFL011	102	610	60



# LED GARDEN AND PATH LIGHTS

code **LFL020**

**LFL021**

casing aluminum

finishing black painting

lampping E14 socket

Supplied with

4W led candle lamp

Lumens 360LM

CRI Ra>80

Beam Acrylic diffuser

lamp color 2700K/3000K/4000K/6000K

Input AC100-240V

lamp inside changeable

installation   **IP65**

surface

customizable

 concrete grey paint  
similar to RAL7037

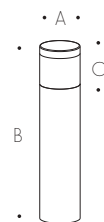
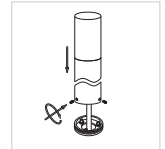
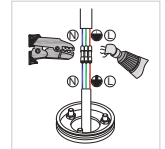

code	A/mm	B/mm	C/mm
LFL020	60	700	100
LFL021	80	700	130

# LED GARDEN AND PATH LIGHTS

code **LFL022**

**LFL023**

**LFL024**

casing aluminum

finishing black painting

lamping E27 socket

Supplied with  
4W led candle lamp

Lumens 360LM

CRI Ra>80

Beam Acrylic diffuser

lamp color 2700K/3000K/4000K/6000K

Input AC100-240V

lamp inside changeable

installation    IP65

surface  
customizable

 concrete grey paint  
similar to RAL7037

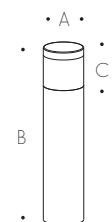
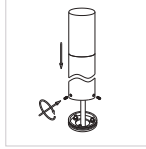
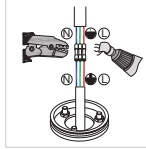
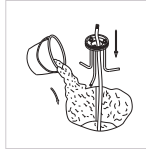

code	A/mm	B/mm	C/mm
LFL022	102	350	150
LFL023	102	550	150
LFL024	102	750	150



# LED GARDEN AND PATH LIGHTS

code **LFL013**  
**LFL014**  
**LFL015**

casing aluminum  
 finishing black painting  
 lamping COB 6W  
 Lumens 500LM  
 CRI Ra>90  
 Beam Solid acrylic diffuser  
 led color 2700K/**3000K**/4000K/6000K  
 Input AC100-240V  
 built-in power-supply  
 installation    IP65

code **LFL013-IN12**  
**LFL014-IN12**  
**LFL015-IN12**

Input DC 12/24V  
 built-in power-supply  
 installation in parallel

surface customizable  
 concrete grey paint similar to RAL7037

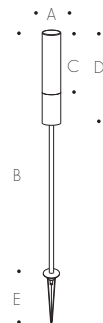
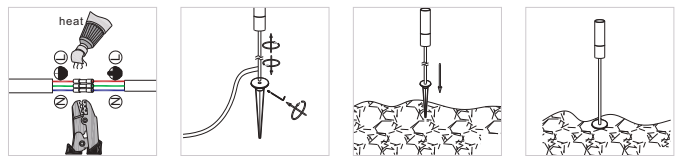

code	A/mm	B/mm	C/mm	D/mm	E/mm
LFL013	60	820	200	320	207
LFL014	60	1020	200	320	207
LFL015	60	1220	200	320	207

# LED GARDEN AND PATH LIGHTS

code **LFL016**  
**LFL017**  
**LFL018**

casing aluminum  
 finishing black painting  
 lamping LED 1W  
 Lumens 70LM  
 CRI Ra>80  
 Beam Solid acrylic diffuser  
 led color 2700K/**3000K**/4000K/6000K

Input AC 100-240V  
 external power-supply

installation   **CE IP65**

code **LFL016-12V**  
**LFL017-12V**  
**LFL018-12V**

Input DC 12/24V  
 external power-supply  
 installation in parallel

surface customizable  
 concrete grey point similar to RAL7037

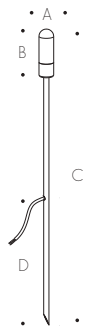
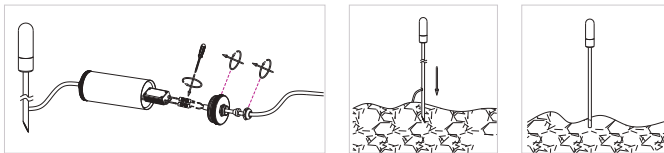

code	A/mm	B/mm	C/mm	D/mm
LFL016	28	90	1000	250
LFL017	28	90	800	250
LFL018	28	90	600	250



# LED GARDEN AND PATH LIGHTS

code **LFL026**

casing aluminum

finishing black painting

lamping SMD 10W

Lumens 1000LM

CRI Ra>80

Beam Solid acrylic diffuser

led color 2700K/~~3000K~~/4000K/6000K

Input AC 100-240V

built-in power-supply

installation    IP65

code **LFL026-12V**

Input DC 12/24V

built-in power-supply

installation in parallel

surface customizable

 concrete grey paint similar to RAL7037

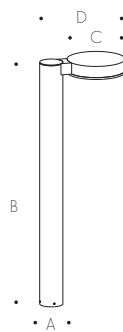
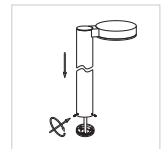
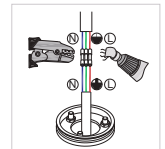
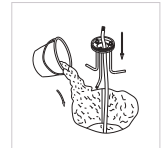

code	A/mm	B/mm	C/mm	D/mm
LFL026	60	700	150	225





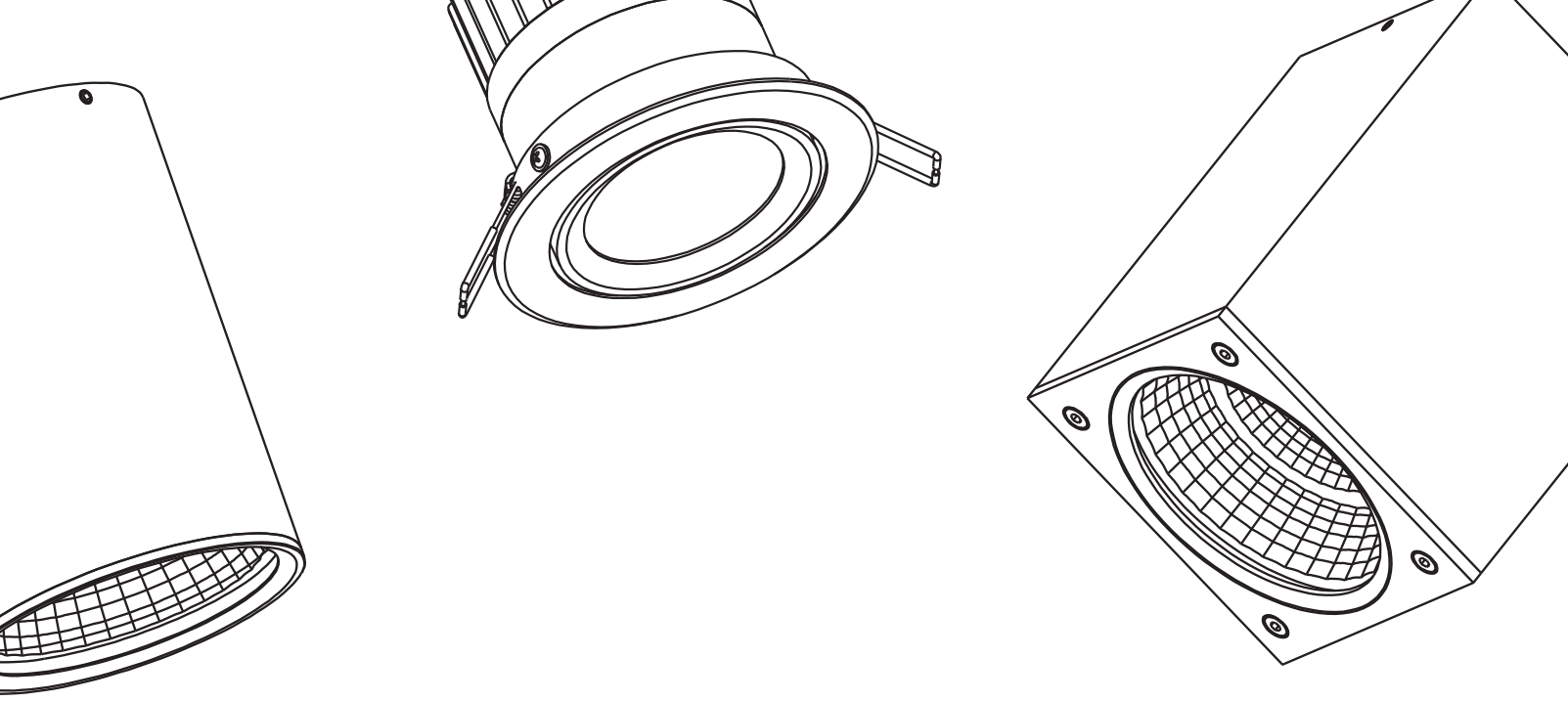





# LED OUTDOOR CEILING LIGHTS



EXTERIOR  
RECESSED MOUNTED  
CEILING SPOTLIGHT



code **LDC337**

casing aluminum / black painting  
lamping COB 12W / Ra>90 / 900LM  
Beam 15/24/38/60 degree  
2700K/3000K/4000K/6000K  
installation     IP65

 cut-out dia 125mm

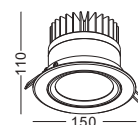





surface  
customizable

 white paint  
similar to RAL9003

 concrete grey paint  
similar to RAL7037

code **LDC336**

casing aluminum / black painting  
lamping COB 9W / Ra>90 / 800LM  
Beam 15/24/38/60 degree  
2700K/3000K/4000K/6000K  
installation     IP65

 cut-out dia 100mm

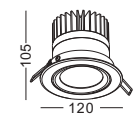

surface  
customizable

 white paint  
similar to RAL9003

 concrete grey paint  
similar to RAL7037

code **LDC335**

casing aluminum / black painting  
lamping COB 6W / Ra>90 / 500LM  
Beam 15/24/38/60 degree  
2700K/3000K/4000K/6000K  
installation     IP65

 cut-out dia 80mm

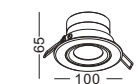

surface  
customizable

 white paint  
similar to RAL9003

 concrete grey paint  
similar to RAL7037

EXTERIOR  
SURFACE MOUNTED  
CEILING DOWNLIGHT

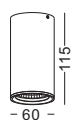

code **LBL183**

surface customizable

white paint similar to RAL9003

concrete grey paint similar to RAL7037

casing aluminum / black painting / lamping COB 5W / Ra>90 / 430LM / Beam 15/24/38/60 degree / 2700K/3000K/4000K/6000K

installation IP65

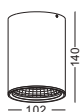

code **LBL184**

surface customizable

white paint similar to RAL9003

concrete grey paint similar to RAL7037

casing aluminum / black painting / lamping COB 12W / Ra>90 / 900LM / Beam 15/24/38/60 degree / 2700K/3000K/4000K/6000K

installation IP65

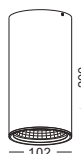

code **LBL185**

surface customizable

white paint similar to RAL9003

concrete grey paint similar to RAL7037

casing aluminum / black painting / lamping COB 20W / Ra>90 / 1700LM / Beam 15/24/38/60 degree / 2700K/3000K/4000K/6000K

installation IP65



EXTERIOR  
SURFACE MOUNTED  
CEILING DOWNLIGHT

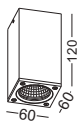

code **LBL186**

surface customizable

white paint similar to RAL9003

concrete grey paint similar to RAL7037

casing aluminum / black painting / lamping COB 5W / Ra>90 / 430LM / Beam 15/24/38/60 degree / 2700K/3000K/4000K/6000K

installation     IP65

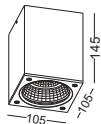

code **LBL187**

surface customizable

white paint similar to RAL9003

concrete grey paint similar to RAL7037

casing aluminum / black painting / lamping COB 12W / Ra>90 / 900LM / Beam 15/24/38/60 degree / 2700K/3000K/4000K/6000K

installation     IP65

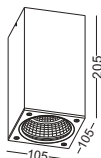

code **LBL188**

surface customizable

white paint similar to RAL9003

concrete grey paint similar to RAL7037

casing aluminum / black painting / lamping COB 20W / Ra>90 / 1700LM / Beam 15/24/38/60 degree / 2700K/3000K/4000K/6000K

installation     IP65

**LED STRIPS**

**LED TUBES**

**LED BULBS**



## 220V INPUT LED STRIP



220-240V DIRECT INPUT

HIGH BRIGHTNESS GOLDEN LINE SMD CHIP

NO NEED FOR TRANSFORMER



installed with end plug



end cap sealed by silicone



fasten clip fixed by screws



item No.LTEC030  
end plug for less than  
30meter



item No.LTEC100  
end plug for less than  
50meter

code **LTP003**

lamping SMD 5050 / 60 chips per meter  
/ Ra>80 / 14.4W per meter

Beam 2700K/3000K/4000K/6000K  
RED / GREEN / BLUE

Packing 100 meter / carton

installation     IP44



## 12V LED STRIPS



### LTP001

Ip20 for indoor use

Cut every three chips

cool white,warm white,neutral white

red,green,blue,yellow available

12V power-supply



### LTP002

Ip43 for outdoor use

transparent silicon coated

Cut every three chips

cool white,warm white,neutral white

red,green,blue,yellow available

12V power-supply

Order code	Size	Chips	Qty,chips/M	Watt/M	Lumens	Color available	Input voltage	Length per rope	IP RATING
LTP001	10mm	5050	60pcs	14.4W	720lm	ww/cw/nw/R/Y/B/G	12V	10 meter	Ip20
LTP002	10mm	5050	60pcs	14.4W	720lm	ww/cw/nw/R/Y/B/G	12V	10meter	IP43

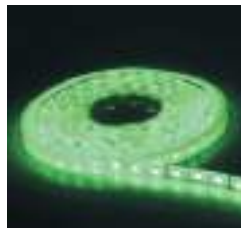

Check price list  
and consult with sales  
for specificaitons of  
DC power-supply







LTB001



LTB002



LTB003



LTB004

## T8 LED Integrative Bracket

Constant Current Driver/No flicker  
 High Brightness Golden Line SMD Chip  
 Enhanced Aluminum Case

Order code	Length	Chips	Qty.chips	Watt	Lumens	CRI	CCT	Input voltage	IP Rating
LTB001-06	0.6M	2835	48pcs	9W	1008lm	Ra>80	3000K/4000K/6000K	185-265V	IP20
LTB001-09	0.9M	2835	72pcs	14W	1512lm	Ra>80	3000K/4000K/6000K	185-265V	IP20
LTB001-12	1.2M	2835	96pcs	18W	2016lm	Ra>80	3000K/4000K/6000K	185-265V	IP20

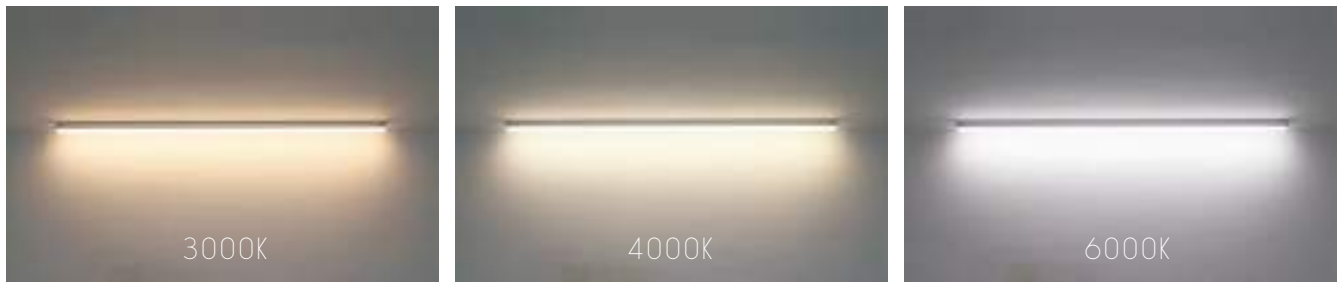

## T8 LED Separable Bracket

Order code	Length	Chips	Qty.chips	Watt	Lumens	CRI	CCT	Input voltage	IP Rating
LTB002-06	0.6M	2835	48pcs	9W	1008lm	Ra>80	3000K/4000K/6000K	185-265V	IP20
LTB002-09	0.9M	2835	72pcs	14W	1512lm	Ra>80	3000K/4000K/6000K	185-265V	IP20
LTB002-12	1.2M	2835	96pcs	18W	2016lm	Ra>80	3000K/4000K/6000K	185-265V	IP20

## T5 LED Integrative Bracket

Constant Current Driver/No flicker  
 High Brightness Golden Line SMD Chip  
 Enhanced Aluminum Case

Order code	Length	Chips	Qty.chips	Watt	Lumens	CRI	CCT	Input voltage	IP Rating
LTB003-06	0.6M	2835	48pcs	9W	1008lm	Ra>80	3000K/4000K/6000K	185-265V	IP20
LTB003-09	0.9M	2835	72pcs	14W	1512lm	Ra>80	3000K/4000K/6000K	185-265V	IP20
LTB003-12	1.2M	2835	96pcs	18W	2016lm	Ra>80	3000K/4000K/6000K	185-265V	IP20

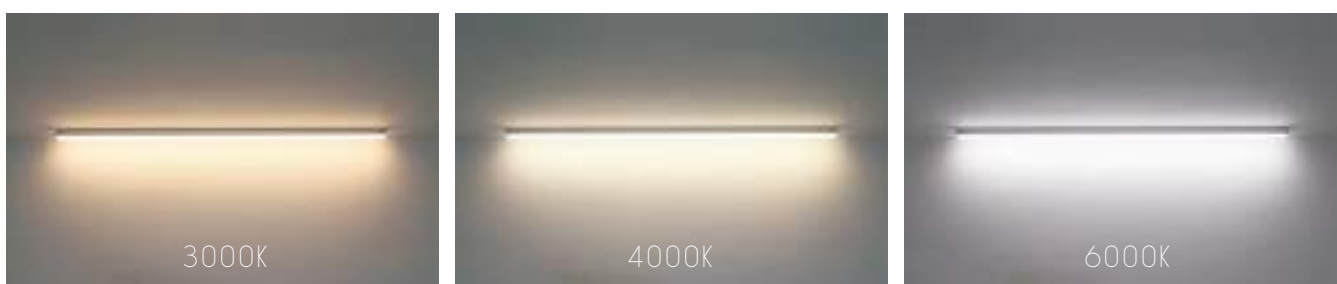

## T8 LED TUBE

Constant Current Driver/No flicker

High Brightness Golden Line SMD Chip

Enhanced Aluminum Case

Order code	Length	Chips	Qty.chips	Watt	Lumens	CRI	CCT	Input voltage	IP Rating
LTB004-06	0.6M	2835	48pcs	9W	1008lm	Ra>80	3000K/4000K/6000K	185-265V	IP20
LTB004-09	0.9M	2835	72pcs	14W	1512lm	Ra>80	3000K/4000K/6000K	185-265V	IP20
LTB004-12	1.2M	2835	96pcs	18W	2016lm	Ra>80	3000K/4000K/6000K	185-265V	IP20



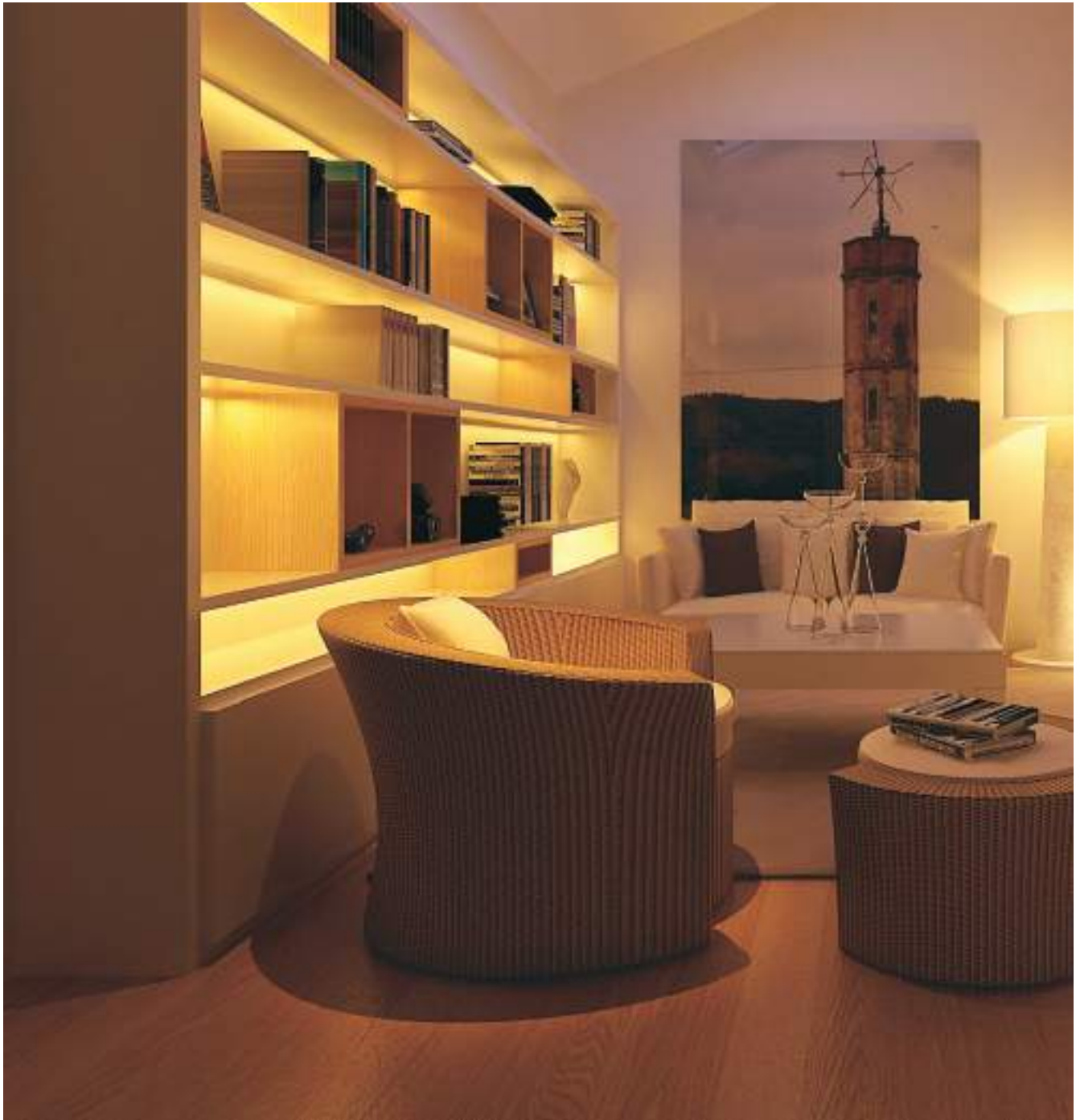

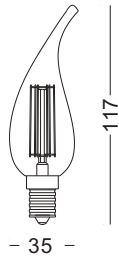

## HIGH QUALITY AND PERFORMANCE LED EDISON CANDLE BULB

Constant current power-supply inside

No flicker problem

High performance light, RA>75, efficiency as much as

95lm per watt for lamp output

Supplied with well designed packing and labeling

2W/4W/6W optional, 2 watt for decoration shadelier

4W/6W for main lighting purpose

### Specifications / details

Order code	socket	Watt	Lumens	CCT	CRI(Ra)	Input voltage	Package/cm
LAM322-E14-WW	E14	2W	180lm	2800K	>75	AC90-265V	37X19X28/100pcs
LAM322-E14-CW	E14	2W	180lm	6000K	>75	AC90-265V	37X19X28/100pcs
LAM324-E14-WW	E14	4W	360lm	2800K	>75	AC90-265V	37X19X28/100pcs
LAM324-E14-CW	E14	4W	360lm	6000K	>75	AC90-265V	37X19X28/100pcs
LAM326-E14-WW	E14	6W	540lm	2800K	>75	AC90-265V	7X19X28/100pcs
LAM326-E14-CW	E14	6W	540lm	6000K	>75	AC90-265V	37X19X28/100pcs

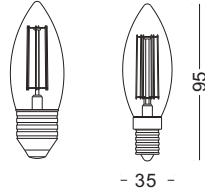

## HIGH QUALITY AND PERFORMANCE LED EDISON CANDLE BULB

Constant current power-supply inside

No flicker problem

High performance light, RA>75, efficiency as much as

95lm per watt for lamp output

Supplied with well designed packing and labling

2W/4W/6W optional, 2 watt for decoration shadelier

4W/6W for main lighting purpose

### Specifications / details

Order code	socket	Watt	Lumens	CCT	CRI(Ra)	Input voltage	Package/cm
LAM312-E14-WW	E14	2W	180lm	2800K	>75	AC90-265V	37X19X28/100pcs
LAM312-E14-CW	E14	2W	180lm	6000K	>75	AC90-265V	37X19X28/100pcs
LAM314-E14-WW	E14	4W	360lm	2800K	>75	AC90-265V	37X19X28/100pcs
LAM314-E14-CW	E14	4W	540lm	6000K	>75	AC90-265V	37X19X28/100pcs
LAM316-E14-WW	E14	6W	540lm	2800K	>75	AC90-265V	37X19X28/100pcs
LAM316-E14-CW	E14	6W	540lm	6000K	>75	AC90-265V	37X19X28/100pcs
LAM312-E27-WW	E27	2W	180lm	2800K	>75	AC90-265V	37X19X28/100pcs
LAM312-E27-CW	E27	2W	180lm	6000K	>75	AC90-265V	37X19X28/100pcs
LAM314-E27-WW	E27	4W	360lm	2800K	>75	AC90-265V	37X19X28/100pcs
LAM314-E27-CW	E27	4W	540lm	6000K	>75	AC90-265V	37X19X28/100pcs
LAM316-E27-WW	E27	6W	540lm	2800K	>75	AC90-265V	37X19X28/100pcs
LAM316-E27-CW	E27	6W	540lm	6000K	>75	AC90-265V	37X19X28/100pcs

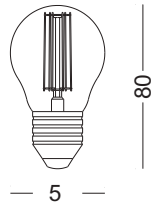

## HIGH QUALITY AND PERFORMANCE LED EDISON CANDLE BULB

Constant current power-supply inside

No flicker problem

High performance light, RA>75, efficiency as much as

95lm per watt for lamp output

Supplied with well designed packing and labling

2W/4W/6W optional, 2 watt for decoration shadelier

4W/6W for main lighting purpose

### Specifications / details

Order code	socket	Watt	Lumens	CCT	CRI(Ra)	Input voltage	Package/cm
LAM332-E27-WW	E27	2W	180lm	2800K	>75	AC90-265V	37X19X28/100pcs
LAM332-E27-CW	E27	2W	180lm	6000K	>75	AC90-265V	37X19X28/100pcs
LAM334-E27-WW	E27	4W	360lm	2800K	>75	AC90-265V	37X19X28/100pcs
LAM334-E27-CW	E27	4W	360lm	6000K	>75	AC90-265V	37X19X28/100pcs
LAM336-E27-WW	E27	6W	540lm	2800K	>75	AC90-265V	37X19X28/100pcs
LAM336-E27-CW	E27	6W	540lm	6000K	>75	AC90-265V	37X19X28/100pcs

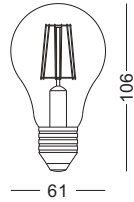

## HIGH QUALITY AND PERFORMANCE LED EDISON CANDLE BULB

Constant current power-supply inside

No flicker problem

High performance light, RA>75, efficiency as much as

95lm per watt for lamp output

Supplied with well designed packing and labling

2W/4W/6W optional, 2 watt for decoration shadelier

4W/6W for main lighting purpose

### Specifications / details

Order code	socket	Watt	Lumens	CCT	CRI(Ra)	Input voltage	Package/cm
LAM344-E27-WW	E27	4W	360lm	2800K	>75	AC90-265V	37X19X28/100pcs
LAM344-E27-CW	E27	4W	360lm	6000K	>75	AC90-265V	37X19X28/100pcs
LAM346-E27-WW	E27	6W	540lm	2800K	>75	AC90-265V	37X19X28/100pcs
LAM346-E27-CW	E27	6W	540lm	6000K	>75	AC90-265V	37X19X28/100pcs





# LED AR111 BULBS

---



Standard Ar111 LED Bulb

GU10/E27/ G5.3/ Outdoor IP65

SMD 6W/9W /COB 9W led optional

Black/ White painting finish

12V/220V input available

15/20/30/60 degree available

for beam angle

Casting Aluminium lamp body

Unique heat sink design

Standard Ar111 size

Fit for all Ar111 lamp case

in the book



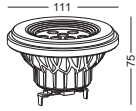

LAM060A-G53

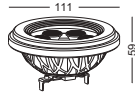

LAM060B-G53

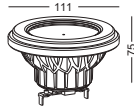

LAM060C-G53

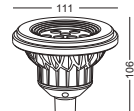

LAM060A-GU10

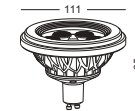

LAM060B-GU10

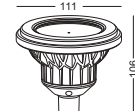

LAM060C-GU10

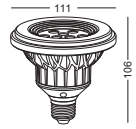

LAM060A-E27

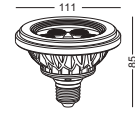

LAM060B-E27

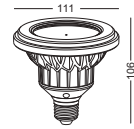

LAM060C-E27

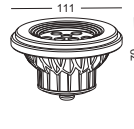

LAM060A-OD

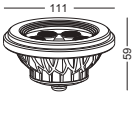

LAM060B-OD

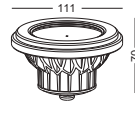

LAM060C-OD

ITEM NO.	lamping	socket	input	lumens	angle	CRI	color available	protection	finish
LAM060A-G53-WT	xpe 9W	G53	12V	720lm	15/30/60 degree	Ra>80	2700/3000/4000/6000K	Class III	white painting
LAM060B-G53-WT	led 6W	G53	12V	480lm	10/30/45 degree	Ra>80	2700/3000/4000/6000K	Class III	white painting
LAM060C-G53-WT	cob 9W	G53	12V	800lm	10/20/30 degree	Ra>90	2700/3000/4000/6000K	Class III	white painting
LAM060A-G53-BK	xpe 9W	G53	12V	720lm	15/30/60 degree	Ra>80	2700/3000/4000/6000K	Class III	black painting
LAM060B-G53-BK	led 6W	G53	12V	480lm	10/30/45 degree	Ra>80	2700/3000/4000/6000K	Class III	black painting
LAM060C-G53-BK	cob 9W	G53	12V	800lm	10/20/30 degree	Ra>90	2700/3000/4000/6000K	Class III	black painting
LAM060A-GU10-WT	xpe 9W	GU10	220V	720lm	15/30/60 degree	Ra>80	2700/3000/4000/6000K	Class II	white painting
LAM060B-GU10-WT	led 6W	GU10	220V	480lm	10/30/45 degree	Ra>80	2700/3000/4000/6000K	Class II	white painting
LAM060C-GU10-WT	cob 9W	GU10	220V	800lm	10/20/30 degree	Ra>90	2700/3000/4000/6000K	Class II	white painting
LAM060A-GU10-BK	xpe 9W	GU10	220V	720lm	15/30/60 degree	Ra>80	2700/3000/4000/6000K	Class II	black painting
LAM060B-GU10-BK	led 6W	GU10	220V	480lm	10/30/45 degree	Ra>80	2700/3000/4000/6000K	Class II	black painting
LAM060C-GU10-BK	cob 9W	GU10	220V	800lm	10/20/30 degree	Ra>90	2700/3000/4000/6000K	Class II	black painting
LAM060A-E27-WT	xpe 9W	E27	220V	720lm	15/30/60 degree	Ra>80	2700/3000/4000/6000K	Class II	white painting
LAM060B-E27-WT	led 6W	E27	220V	480lm	10/30/45 degree	Ra>80	2700/3000/4000/6000K	Class II	white painting
LAM060C-E27-WT	cob 9W	E27	220V	800lm	10/20/30 degree	Ra>90	2700/3000/4000/6000K	Class II	white painting
LAM060A-E27-BK	xpe 9W	E27	220V	720lm	15/30/60 degree	Ra>80	2700/3000/4000/6000K	Class II	black painting
LAM060B-E27-BK	led 6W	E27	220V	480lm	10/30/45 degree	Ra>80	2700/3000/4000/6000K	Class II	black painting
LAM060C-E27-BK	cob 9W	E27	220V	800lm	10/20/30 degree	Ra>90	2700/3000/4000/6000K	Class II	black painting
LAM060A-OD-BK	xpe 9W	E27	12V	720lm	15/30/60 degree	Ra>80	2700/3000/4000/6000K	Class III	black painting
LAM060B-OD-BK	led 6W	E27	12V	480lm	10/30/45 degree	Ra>80	2700/3000/4000/6000K	Class III	black painting
LAM060C-OD-BK	cob 9W	E27	12V	800lm	10/20/30 degree	Ra>90	2700/3000/4000/6000K	Class III	black painting

GU10  
LAMP  
CASING



LDC926-SL-GU10



LDC926-WT-GU10



LDC969-GU10



LDC988-BK-GU10



LDC988-GD-GU10



LDC988-WT-GU10



LDC979B-GU10



LDC978B-GU10



LDC323



LDC324



LDC325



LDC955-GU10



LDC956-GU10



LDC957-GU10



BL001-WT



BL002-WT



BL003-WT



BL001-BK



BL002-BK



BL003-BK

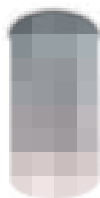

C006-GU10



C007-GU10



C008-GU10



LBL086

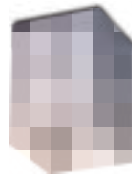

C003S



C003SB-BK



C003SB-SL



LWA187-BK-GU10



LWA187-WT-GU10



LBL125-GU10



LBL126-GU10



LBL121-GU10



LBL122-GU10

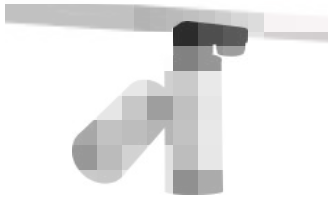

LSP115-GU10

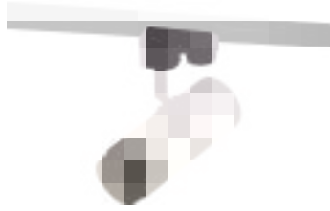

LSP117-GU10



LSP117-WT-GU10



LSP117-BK-GU10



LSP114-WT-GU10



LSP114-BK-GU10



8139-BK



8147



LPL118-GU10



LPL185-GU10



LPL190-GU10



LPL157-GU10



LWA145



LWA146



LWA116-GU10



LWA117-GU10



LWA215-GU10



LWA216-GU10



LWA253-GU10



LWA254-GU10



ODL028-GU10



# GU10 SOCKET CASING DATASHEETS

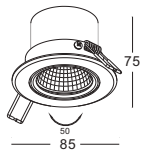

**LDC926-SL-GU10**  
 material: Aluminium  
 GU10 socket max50W  
 bulb not included  
 IP20 / class III / **CE**  
 Anodized silver  
 cut-off dia 70mm

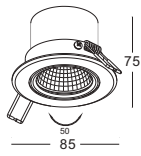

**LDC926-WT-GU10**  
 material: Aluminium  
 GU10 socket max50W  
 bulb not included  
 IP20 / class III / **CE**  
 white painting  
 cut-off dia 70mm

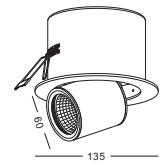

**LDC969-GU10**  
 material: Aluminium  
 GU10 socket max50W  
 bulb not included  
 IP20 / class III / **CE**  
 white painting  
 cut-off dia 115mm

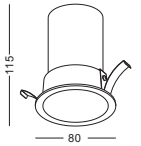

**LDC988-BK-GU10**  
 material: Aluminium  
 GU10 socket max50W  
 bulb not included  
 IP20 / class III / **CE**  
 Anodized silver  
 cut-off dia 72mm

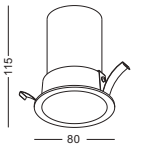

**LDC988-GD-GU10**  
 material: Aluminium  
 GU10 socket max50W  
 bulb not included  
 IP20 / class III / **CE**  
 Anodized gold  
 cut-off dia 72mm

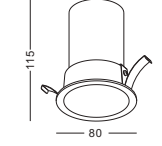

**LDC988-WT-GU10**  
 material: Aluminium  
 GU10 socket max50W  
 bulb not included  
 IP20 / class III / **CE**  
 white painting  
 cut-off dia 72mm

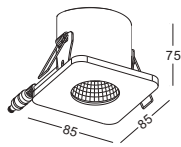

**LDC979B-GU10**  
 material: Aluminium  
 GU10 socket max50W  
 bulb not included  
 IP20 / class III / **CE**  
 Anodized silver  
 cut-off dia 70mm

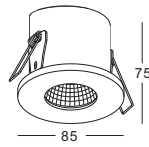

**LDC978B-GU10**  
 material: Aluminium  
 GU10 socket max50W  
 bulb not included  
 IP20 / class III / **CE**  
 Anodized silver  
 cut-off dia 70mm

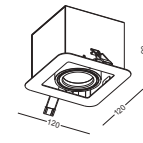

**LDC323**  
 material: Aluminium  
 GU10 socket max50W  
 bulb not included  
 IP20 / class III / **CE**  
 white painting  
 cut-off 105X105mm

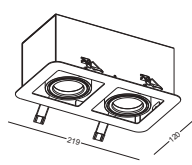

**LDC324**  
 material: Aluminium  
 2XGU10 socket max50W  
 bulb not included  
 IP20 / class III / **CE**  
 white painting  
 cut-off 204X105mm

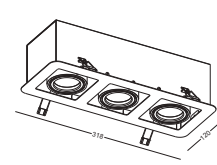

**LDC325**  
 material: Aluminium  
 3XGU10 socket max50W  
 bulb not included  
 IP20 / class III / **CE**  
 white painting  
 cut-off 303X105mm

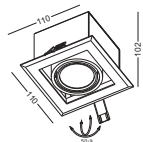

**LDC955-GU10**  
 material: Aluminium  
 GU10 socket max50W  
 bulb not included  
 IP20 / class III / **CE**  
 white painting  
 cut-off 90X90mm



**LDC956-GU10**  
 material: Aluminium  
 2XGU10 socket max50W  
 bulb not included  
 IP20 / class III / **CE**  
 white painting  
 cut-off 165X90mm



**LDC957-GU10**  
 material: Aluminium  
 3XGU10 socket max50W  
 bulb not included  
 IP20 / class III / **CE**  
 white painting  
 cut-off 240X90mm

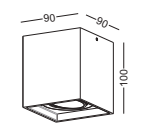

**BLO01-WT**  
 material: aluminium  
 Gu10 socket max50W  
 bulb not included  
 IP20 / class II / **CE**  
 white painting

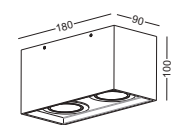

**BLO02-WT**  
 material: aluminium  
 2xGu10 socket max50W  
 bulb not included  
 IP20 / class II / **CE**  
 white painting

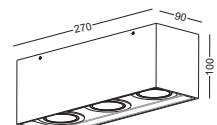

**BLO03-WT**  
 material: aluminium  
 3xGu10 socket max50W  
 bulb not included  
 IP20 / class II / **CE**  
 white painting

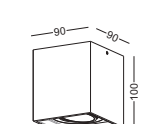

**BLO01-BK**  
 material: aluminium  
 Gu10 socket max50W  
 bulb not included  
 IP20 / class II / **CE**  
 black painting

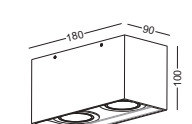

**BLO02-BK**  
 material: aluminium  
 2xGu10 socket max50W  
 bulb not included  
 IP20 / class II / **CE**  
 black painting

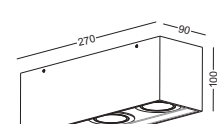

**BLO03-BK**  
 material: aluminium  
 3xGu10 socket max50W  
 bulb not included  
 IP20 / class II / **CE**  
 black painting

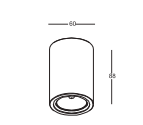

**C006-GU10**  
 material: aluminium  
 Gu10 50W  
 IP20 / class II / **CE**  
 anodized silver

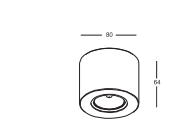

**C007-GU10**  
 material: aluminium  
 Gu10 50W  
 IP20 / class II / **CE**  
 anodized silver

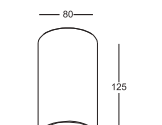

**C008-GU10**  
 material: aluminium  
 Gu10 50W  
 IP20 / class II / **CE**  
 anodized silver

# Gu 10 SOCKET CASING DATASHEETS

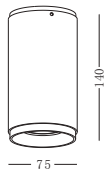

**LBL086**  
material: aluminium  
Gu10 50W  
IP20 / class I / **CE**  
black painting

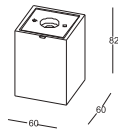

**C003S**  
material: aluminium  
Gu10 50W  
IP20 / class I / **CE**  
anodized silver

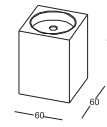

**C003SB-BK**  
material: aluminium  
Gu10 50W  
IP20 / class I / **CE**  
anodized black

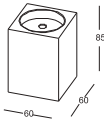

**C003SB-SL**  
material: aluminium  
Gu10 50W  
IP20 / class I / **CE**  
anodized silver

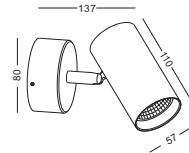

**LWA187-BK-GU10**  
material: aluminium  
Gu10 socket  
bulb not included  
IP20 / class I / **CE**  
anodized black

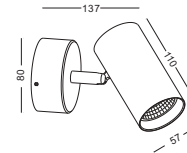

**LWA187-WT-GU10**  
material: aluminium  
Gu10 socket  
bulb not included  
IP20 / class I / **CE**  
white painting

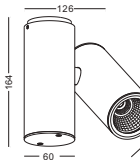

**LBL125-GU10**  
material: aluminium  
Gu10 socket  
bulb not included  
IP20 / class I / **CE**  
white painting

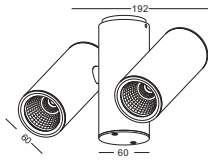

**LBL126-GU10**  
material: aluminium  
2xGu10 socket  
bulb not included  
IP20 / class I / **CE**  
white painting

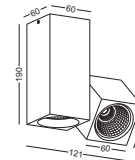

**LBL121-GU10**  
material: aluminium  
2XGu10 socket  
bulb not included  
IP20 / class I / **CE**  
anodized black and silver

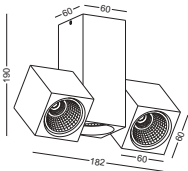

**LBL122-GU10**  
material: aluminium  
3XGu10 socket  
bulb not included  
IP20 / class I / **CE**  
anodized black and silver

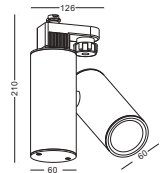

**LSP115-GU10**  
material: aluminium  
Gu10 socket  
bulb not included  
3-lines track adaptor  
IP20 / class I / **CE**  
white painting

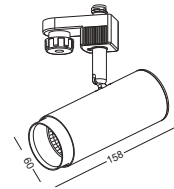

**LSP117-GU10**  
material: aluminium  
Gu10 socket  
bulb not included  
3-lines track adaptor  
IP20 / class I / **CE**  
white painting

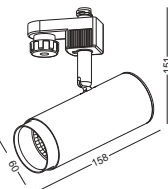

**LSP117-WT-GU10**  
material: aluminium  
Gu10 socket  
bulb not included  
3-lines track adaptor  
IP20 / class I / **CE**  
all white painting

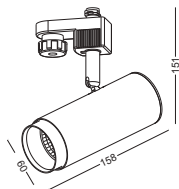

**LSP117-BK-GU10**  
material: aluminium  
Gu10 socket  
bulb not included  
3-lines track adaptor  
IP20 / class I / **CE**  
all black painting



**LSP114-WT-GU10**  
material: aluminium  
Gu10 socket  
bulb not included  
3-lines track adaptor  
IP20 / class I / **CE**  
white painting

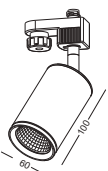

**LSP114-BK-GU10**  
material: aluminium  
Gu10 socket  
bulb not included  
3-lines track adaptor  
IP20 / class I / **CE**  
black painting

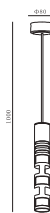

**8139-BK-GU10**  
material: aluminium  
Gu10 socket  
bulb not included  
IP20 / class I / **CE**  
anodized black

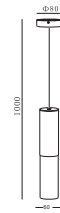

**8147**  
material: aluminium  
12V MR16 35W  
incl transformer 50W  
IP20 / class I / **CE**  
anodized silver and black

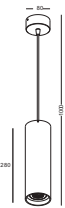

**LPL118-GU10**  
material: aluminium  
Gu10 socket max50W  
bulb not included  
IP20 / class I / **CE**  
white painting



**LPL185-GU10**  
material: aluminium  
Gu10 socket max50W  
bulb not included  
IP20 / class I / **CE**  
anodized silver



**LPL190-GU10**  
material: aluminium  
Gu10 socket max50W  
bulb not included  
IP20 / class I / **CE**  
anodized silver

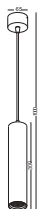

**LPL157-GU10**  
material: aluminium  
Gu10 socket max50W  
bulb not included  
IP20 / class I / **CE**  
anodized silver

## GU10 SOCKET CASING DATASHEETS

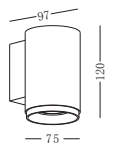

LWA145

material: aluminium  
Gu10 socket max 50W  
bulb not included  
IP20 / class I / **CE**  
black painting

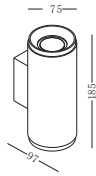

LWA146

material: aluminium  
2xGu10 socket max 50w  
bulb not included  
IP20 / class I / **CE**  
black painting

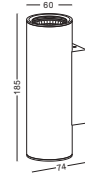

LWA116-GU10

material: aluminium  
2xGu10 socket max 50w  
bulb not included  
IP20 / class I / **CE**  
anodized silver  
with black cap

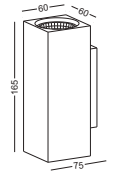

LWA117-GU10

material: aluminium  
2xGu10 socket max 50w  
bulb not included  
IP20 / class I / **CE**  
anodized silver

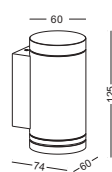

LWA215-GU10

material: Aluminium  
GU10 socket max 10W  
bulb not included  
IP44 / class I / **CE**

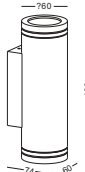

LWA216-GU10

material: Aluminium  
2XGU10 socket  
max 10W  
bulb not included  
IP44 / class I / **CE**

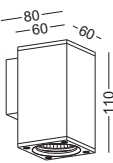

LWA253-GU10

material: Aluminium  
GU10 socket max 10W  
bulb not included  
IP44 / class I / **CE**

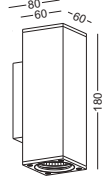

LWA254-GU10

material: Aluminium  
2xGU10 socket max 10W  
bulb not included  
IP44 / class I / **CE**

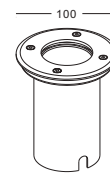

ODL028-GU10

material: Aluminium  
Stainless steel 316 cover  
GU10 socket max 10W  
bulb not included  
IP67 / class I / **CE**  
check manual  
before installation





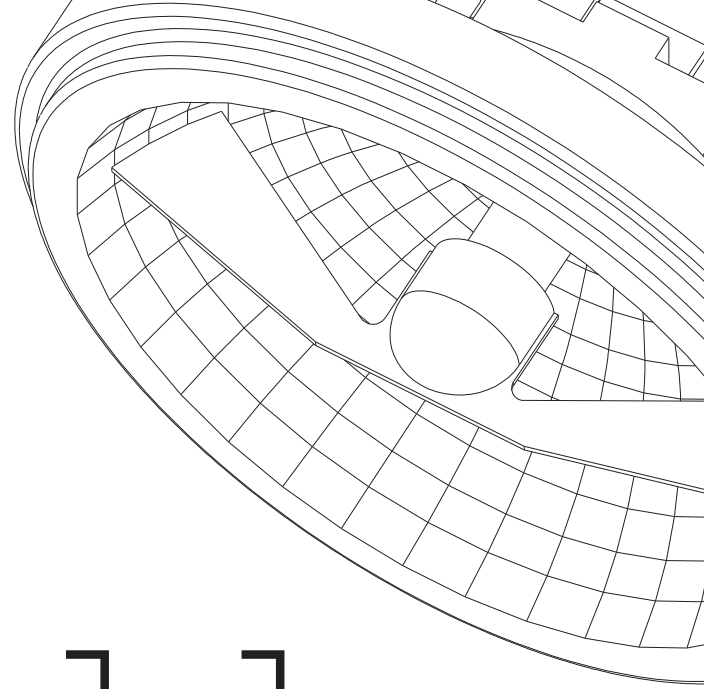

# AR 111 LAMPS

ALL LAMPS IN THIS CATEGORY CAN USE Ar 111 HALOGEN LAMP OR LED Ar 111 IN CHAPTER LED BULBS





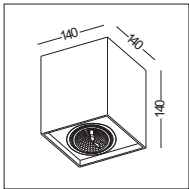

code LBL006-BK  
 casing aluminum  
 finishing black paint  
 lamping halogen Ar 111 35W  
 Beam standard 36 degree  
 supplied with reflector  
 and philips halogen bulb  
 bulb can be easily changed  
 from the back of the reflector



reflector available  
 default



flood

surface  
 customizable

■ concrete grey paint  
 similar to RAL7037

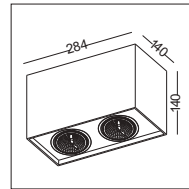

code LBL006-2-BK  
 casing aluminum  
 finishing black paint  
 lamping halogen Ar 111 2X35W  
 Beam standard 36 degree  
 supplied with reflector  
 and philips halogen bulb  
 bulb can be easily changed  
 from the back of the reflector



reflector available  
 default



flood

surface  
 customizable

■ concrete grey paint  
 similar to RAL7037

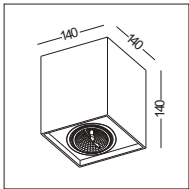

code LBL006-WT  
 casing aluminum  
 finishing white paint  
 lamping halogen Ar 111 35W  
 Beam standard 36 degree  
 supplied with reflector  
 and philips halogen bulb  
 bulb can be easily changed  
 from the back of the reflector



reflector available  
 default



flood

surface  
 customizable

■ concrete grey paint  
 similar to RAL7037

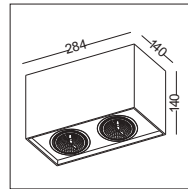

code LBL006-2-WT  
 casing aluminum  
 finishing white paint  
 lamping halogen Ar 111 2X35W  
 Beam standard 36 degree  
 supplied with reflector  
 and philips halogen bulb  
 bulb can be easily changed  
 from the back of the reflector



reflector available  
 default



flood

surface  
 customizable

■ concrete grey paint  
 similar to RAL7037



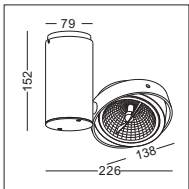

code LSP 126-WT  
 casing aluminum  
 finishing white paint  
 lamping halogen Ar 111 35W  
 Beam standard 36 degree  
 supplied with reflector  
 and philips halogen bulb  
 bulb can be easily changed  
 from the back of the reflector



reflector available

default



flood

surface  
 customizable

■ concrete grey paint  
 similar to RAL7037

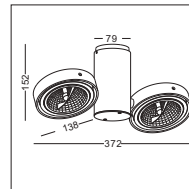

code LSP 127-WT  
 casing aluminum  
 finishing white paint  
 lamping halogen Ar 111 2X35W  
 Beam standard 36 degree  
 supplied with reflector  
 and philips halogen bulb  
 bulb can be easily changed  
 from the back of the reflector



reflector available

default



flood

surface  
 customizable

■ concrete grey paint  
 similar to RAL7037

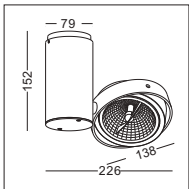

code LSP 126-SL  
 casing aluminum  
 finishing anodized silver  
 lamping halogen Ar 111 35W  
 Beam standard 36 degree  
 supplied with reflector  
 and philips halogen bulb  
 bulb can be easily changed  
 from the back of the reflector



reflector available

default



flood

surface  
 customizable

concrete grey paint  
 similar to RAL7037

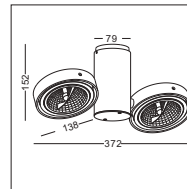

code LSP 127-SL  
 casing aluminum  
 finishing anodized silver  
 lamping halogen Ar 111 2X35W  
 Beam standard 36 degree  
 supplied with reflector  
 and philips halogen bulb  
 bulb can be easily changed  
 from the back of the reflector



reflector available

default





flood

surface  
 customizable

concrete grey paint  
 similar to RAL7037



code LSP128-BK  
 casing aluminum / black painting  
 lamping Ar 111 35W /supplied with  
 philips halogen bulbs and  
 transformers  
 Beam 36 degree aluminum reflector  
 installation     IP20

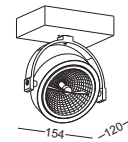

surface  
 customizable  
 concrete  
 grey paint  
 similar to  
 RAL7037



code LSP129-BK  
 casing aluminum / black painting  
 lamping Ar 111 2x35W /supplied with  
 philips halogen bulbs and  
 transformers  
 Beam 36 degree aluminum reflector  
 installation     IP20

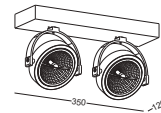

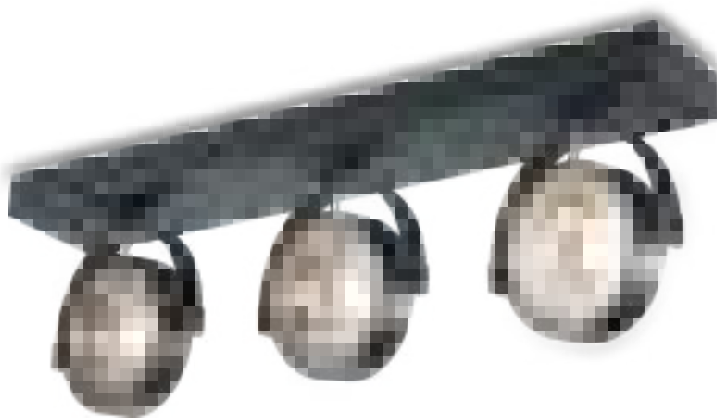

surface  
 customizable  
 concrete  
 grey paint  
 similar to  
 RAL7037

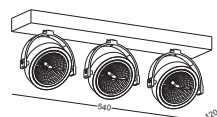

code LSP130-BK  
 casing aluminum / black painting  
 lamping Ar 111 3x35W /supplied with  
 philips halogen bulbs and  
 transformers  
 Beam 36 degree aluminum reflector  
 installation     IP20





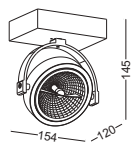

surface  
 customizable  
 concrete  
 grey paint  
 similar to  
 RAL7037

code LSP 128-WT  
 casing aluminum / white painting  
 lamping Ar 111 35W /supplied with  
 philips halogen bulbs and  
 transformers  
 Beam 36 degree aluminum reflector  
 installation     IP20



surface  
 customizable  
 concrete  
 grey paint  
 similar to  
 RAL7037





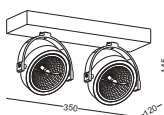

code LSP 129-WT  
 casing aluminum / white painting  
 lamping Ar 111 2x35W /supplied with  
 philips halogen bulbs and  
 transformers  
 Beam 36 degree aluminum reflector  
 installation     IP20

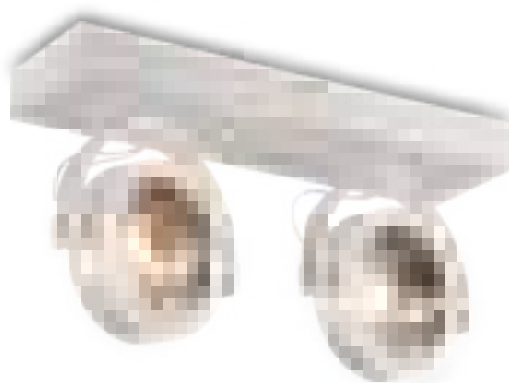

surface  
 customizable  
 concrete  
 grey paint  
 similar to  
 RAL7037





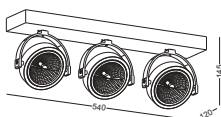

code LSP 130-WT  
 casing aluminum / white painting  
 lamping Ar 111 3x35W /supplied with  
 philips halogen bulbs and  
 transformers  
 Beam 36 degree aluminum reflector  
 installation     IP20

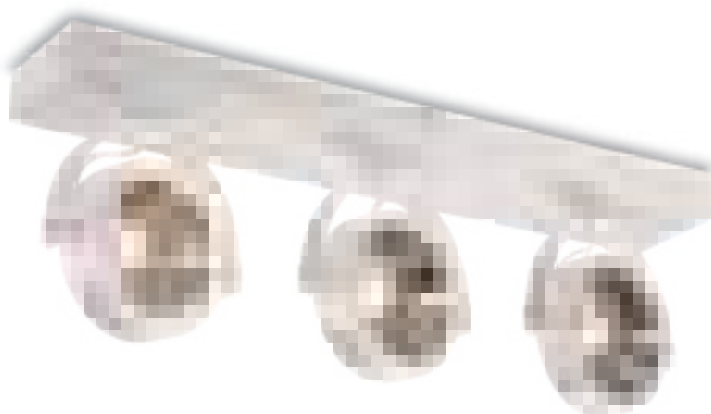

surface  
 customizable  
 concrete  
 grey paint  
 similar to  
 RAL7037







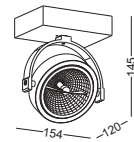

code LSP128-SL  
casing aluminum / anodized silver  
lamping Ar111 35W /supplied with philips halogen bulbs and transformers  
Beam 36 degree aluminum reflector  
installation     IP20

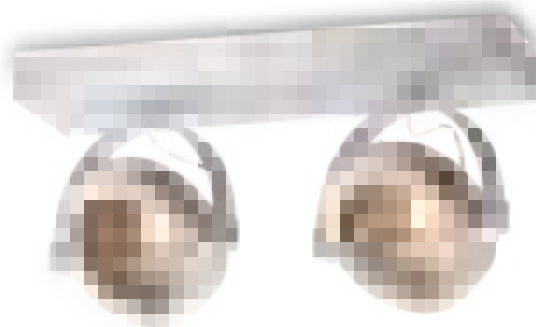

surface customizable  
 concrete grey paint similar to RAL7037





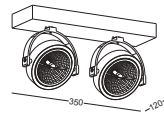

code LSP129-SL  
casing aluminum / anodized silver  
lamping Ar111 2x35W /supplied with philips halogen bulbs and transformers  
Beam 36 degree aluminum reflector  
installation     IP20

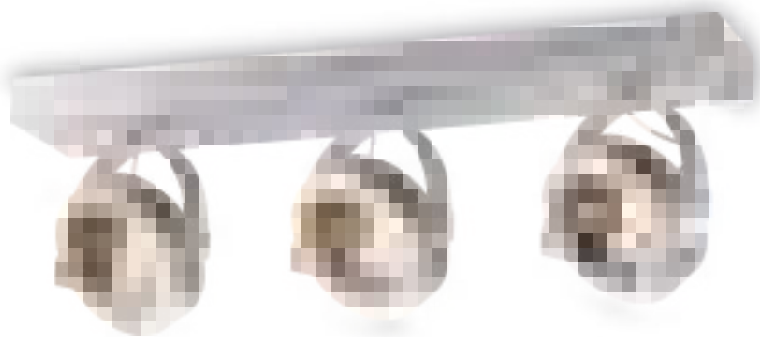





surface customizable  
 concrete grey paint similar to RAL7037

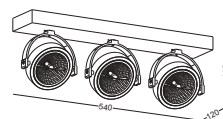

code LSP130-SL  
casing aluminum / anodized silver  
lamping Ar111 3x35W /supplied with philips halogen bulbs and transformers  
Beam 36 degree aluminum reflector  
installation     IP20





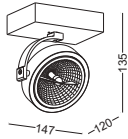

surface customizable  
 concrete grey paint similar to RAL7037

code LSP131-SL  
 casing aluminum / anodized silver  
 lamping Ar 111 35W /supplied with  
 philips halogen bulbs and  
 transformers  
 Beam 36 degree aluminum reflector  
 installation     IP20



surface  
 customizable  
 concrete  
 grey paint  
 similar to  
 RAL7037



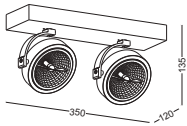

code LSP132-SL  
 casing aluminum / anodized silver  
 lamping Ar 111 2x35W /supplied with  
 philips halogen bulbs and  
 transformers  
 Beam 36 degree aluminum reflector  
 installation     IP20

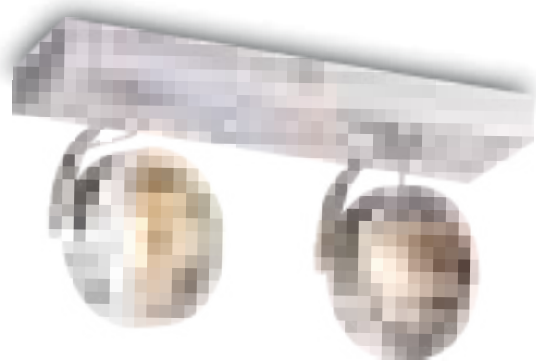

surface  
 customizable  
 concrete  
 grey paint  
 similar to  
 RAL7037



code LSP133-SL  
 casing aluminum / anodized silver  
 lamping Ar 111 3x35W /supplied with  
 philips halogen bulbs and  
 transformers  
 Beam 36 degree aluminum reflector  
 installation     IP20

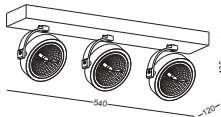

surface  
 customizable  
 concrete  
 grey paint  
 similar to  
 RAL7037





surface  
customizable

anodized silver  
brushed linear

black paint  
equal to RAL9011

concrete grey paint  
similar to RAL7037

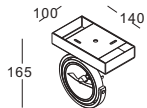

code SPO 11-WT

■ ⊕ CE ▽ IP20 supplied with philips halogen  
bulbs and transformers

casing aluminum / white painting / lamping Ar 111 35W / Beam 36 degree aluminum reflector

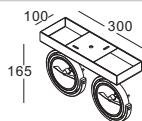

code SPO 12-WT

■ ⊕ CE ▽ IP20 supplied with philips halogen  
bulbs and transformers

casing aluminum / white painting / lamping Ar 111 2x35W / Beam 36 degree aluminum reflector

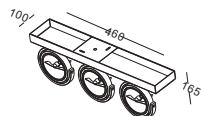

code SPO 13-WT

■ ⊕ CE ▽ IP20 supplied with philips halogen  
bulbs and transformers

casing aluminum / white painting / lamping Ar 111 3x35W / Beam 36 degree aluminum reflector





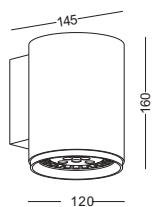

code LWA 147  
 casing aluminum / black painting  
 lamping Ar 111 35W /supplied with philips halogen bulbs and transformers  
 Beam 36 degree aluminum reflector  
 installation IP20

surface customizable concrete grey paint similar to RAL7037  
 white paint similar to RAL9003

Remark lamp source in picture is philips Ar 111 LED 10W, in production is halogen Ar 111 35W bulb

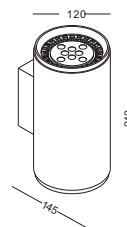

code LWA 148  
 casing aluminum / black painting  
 lamping Ar 111 2x35W /supplied with philips halogen bulbs and transformers  
 Beam 36 degree aluminum reflector  
 installation IP20

surface customizable concrete grey paint similar to RAL7037  
 white paint similar to RAL9003

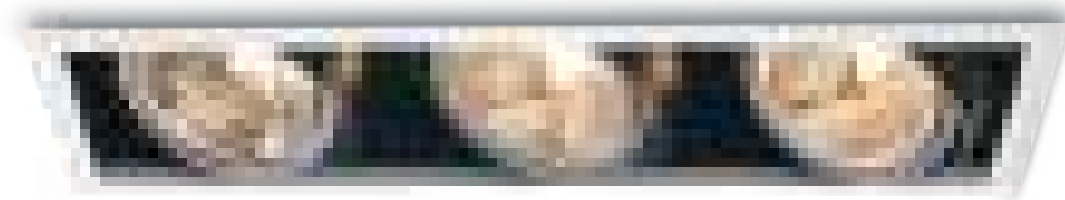
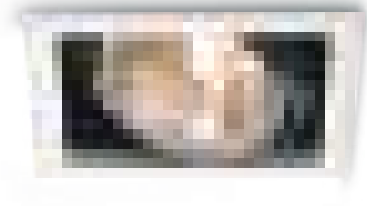
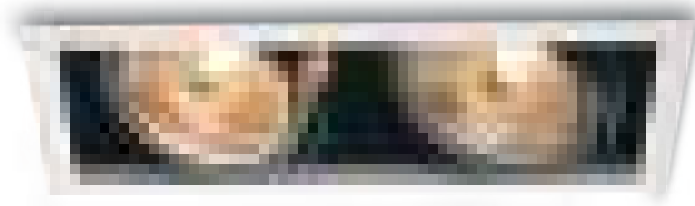

code LDC975

surface customizable  black paint equal to RAL9011  concrete grey paint similar to RAL7037

casing aluminum / black / white painting / lamping Ar 111 35W / Ra>90 / 430LM / Beam 36 degree aluminum reflector



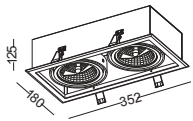

installation      cut-out 162x162mm / supplied with philips halogen bulbs and transformers



code LDC976

surface customizable  black paint equal to RAL9011  concrete grey paint similar to RAL7037

casing aluminum / black / white painting / lamping Ar 111 2x35W / Ra>90 / 430LM / Beam 36 degree aluminum reflector



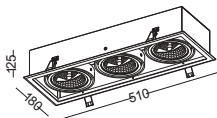

installation      cut-out 334x162mm / supplied with philips halogen bulbs and transformers



code LDC977

surface customizable  black paint equal to RAL9011  concrete grey paint similar to RAL7037

casing aluminum / black / white painting / lamping Ar 111 3x35W / Ra>90 / 430LM / Beam 36 degree aluminum reflector

installation      cut-out 492x162mm / supplied with philips halogen bulbs and transformers



note



**SORRY  
WE HAVE  
NO NAME  
JUST BUY THE  
LAMP  
AND LET'S  
LIGHT YOUR  
PLACE**

**THANK YOU FOR  
WATCHING THE BOOK**