

PROXIMITY SWITCH

Structural category	Cylinder type		Connector type
---------------------	---------------	--	----------------

Outward Appearance code	CZ LM8-□□T /LM8-□□T3	CZ LM12-□T /LM12-□T3	CZ LM18-□T
-------------------------	----------------------	----------------------	------------

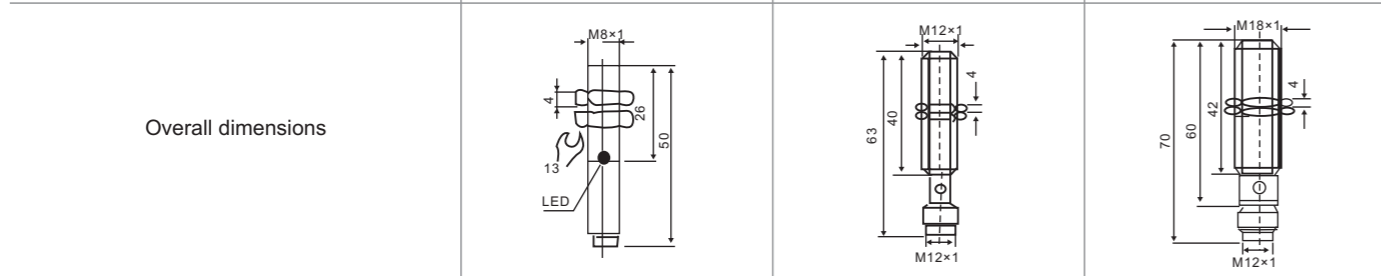

		DETECTION DISTANCE				
		1mm	2mm	5mm		
Flush	DC 10-30 VDC	NPN	NO	CZ LM8-3001NAT	CZ LM12-3002NAT	CZ LM18-3005NAT
			NC	CZ LM8-3001NBT	CZ LM12-3002NBT	CZ LM18-3005NBT
			NO+NC		CZ LM12-3002NCT	CZ LM18-3005NCT
		PNP	NO	CZ LM8-3001PAT	CZ LM12-3002PAT	CZ LM18-3005PAT
			NC	CZ LM8-3001PBT	CZ LM12-3002PBT	CZ LM18-3005PBT
			NO+NC		CZ LM12-3002PCT	CZ LM18-3005PCT
	two wire system	NO	CZ LM8-3001LAT	CZ LM12-3002LAT	CZ LM18-3005LAT	
		NC	CZ LM8-3001LBT	CZ LM12-3002LBT	CZ LM18-3005LBT	
	AC 90-250 VAC	Control-lable silicon	NO		CZ LM12-2002AT	CZ LM18-2005AT
			NC		CZ LM12-2002BT	CZ LM18-2005BT
NO+NC						
Relay output						
		DETECTION DISTANCE				
		2mm	4mm	8mm		
Non-Flush	DC 10-30 VDC	NPN	NO	CZ LM8-3002NAT	CZ LM12-3004NAT	CZ LM18-3008NAT
			NC	CZ LM8-3002NBT	CZ LM12-3004NBT	CZ LM18-3008NBT
			NO+NC		CZ LM12-3004NCT	CZ LM18-3008NCT
		PNP	NO	CZ LM8-3002PAT	CZ LM12-3004PAT	CZ LM18-3008PAT
			NC	CZ LM8-3002PBT	CZ LM12-3004PBT	CZ LM18-3008PBT
			NO+NC		CZ LM12-3004PCT	CZ LM18-3008PCT
	two wire system	NO	CZ LM8-3002LAT	CZ LM12-3004LAT	CZ LM18-3008LAT	
		NC	CZ LM8-3002LBT	CZ LM12-3004LBT	CZ LM18-3008LBT	
	AC 90-250 VAC	Control-lable silicon	NO	CZ LM8-2002AT	CZ LM12-2004AT	CZ LM18-2008AT
			NC		CZ LM12-2004BT	CZ LM18-2008BT
NO+NC						
Relay output						
Controloutput	DC	150mA	200mA			
	SCR/Relay			300mA		
Output voltage drop DC/AC		(NPN PNP) 3V : 3.9V AC 10V DC < 3V AC < 10V				
Consumption current		(NPN PNP) DC 12V 8mA 24V 15mA AC 10mA DC < 15mA AC < 10mA				
Standard detected object		8×8×1(A3 iron)	12×12×1(A3 iron)	18×18×1(A3 iron)		
Repeated precision		0.01	0.01	0.02		
DC/AC		500Hz/10Hz	400Hz/10Hz	200Hz/10Hz		
Working environment temperature		-25°C~+70°C	-25°C~+70°C	-25°C~+70°C		
Insulation resistance		50MΩ	50MΩ	50MΩ		
Shell material		Metal	Metal	Metal		
Protection grade		IP67	IP67	IP67		
Alyemative model at home and abroad		E2E-X1R5-M1	E2E-X2E1-M1	E2E-X5E5-M1		

PROXIMITY SWITCH



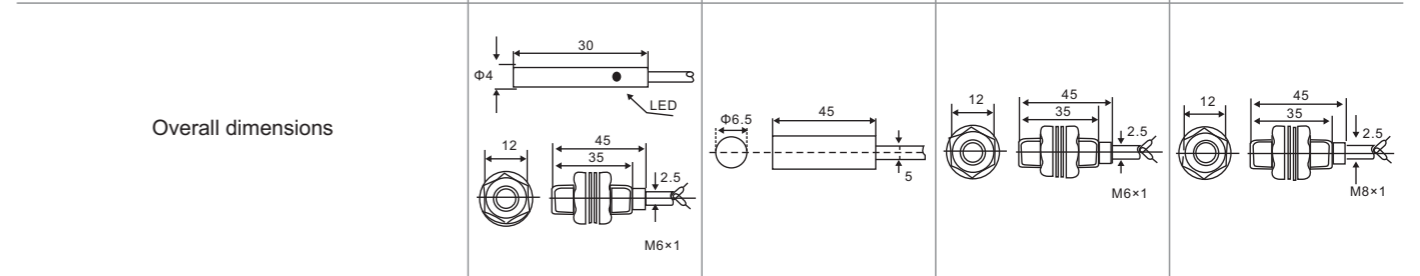

Structural category	Cylinder type			
---------------------	---------------	--	--	--

Outward Appearance code	CZ LM4/LM5	CZ LM6	CZ LM06	CZ LM8
-------------------------	------------	--------	---------	--------





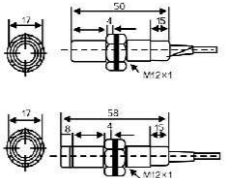
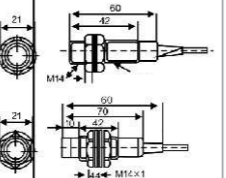
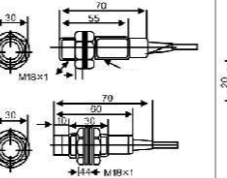
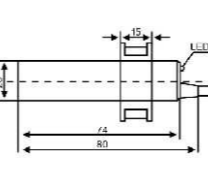

		DETECTION DISTANCE					
		0.8mm/1mm	1mm	1mm	1mm		
Flush	DC 10-30 VDC	NPN	NO	CZ LM4-300.8NA/CZ LM5-3001NA	CZ LM6-3001NA	CZ LM06-3001NA	CZ LM8-3001NA
			NC		CZ LM6-3001NB		CZ LM8-3001NB
			NO+NC				CZ LM8-3001NC
		PNP	NO	CZ LM4-300.8PA/CZ LM5-3001PA	CZ LM6-3001PA	CZ LM06-3001PA	CZ LM8-3001PA
			NC		CZ LM6-3001PB		CZ LM8-3001PB
			NO+NC				CZ LM8-3001PC
	two wire system	NO		CZ LM6-3001LA		CZ LM8-3001LA	
		NC		CZ LM6-3001LB		CZ LM8-2001LB	
	AC 90-250 VAC	Control-lable silicon	NO		CZ LM6-2001A		CZ LM8-2001A
			NC		CZ LM6-2001B		CZ LM8-2001B
NO+NC							
Relay output							
		DETECTION DISTANCE		1.5mm	2mm		
Non-Flush	DC 10-30 VDC	NPN	NO		CZ LM6-3002NA	CZ LM8-3002NA	
			NC		CZ LM6-3002NB	CZ LM8-3002NB	
			NO+NC				
		PNP	NO		CZ LM6-3002PA	CZ LM8-3002PA	
			NC		CZ LM6-3002PB	CZ LM8-3002PB	
			NO+NC				
	two wire system	NO		CZ LM6-3002LA	CZ LM8-3002LA		
		NC		CZ LM6-3002LB	CZ LM8-3002LB		
	AC 90-250 VAC	Control-lable silicon	NO		CZ LM6-2002A	CZ LM8-2002A	
			NC		CZ LM6-2002B	CZ LM8-2002B	
NO+NC							
Relay output							
Controloutput	DC	200mA	200mA	200mA	200mA		
	SCR/Relay						
Output voltage drop DC/AC		(NPN PNP) 3V : 3.9V AC 10V DC < 3V AC < 10V					
Consumption current		(NPN PNP) DC 12V 8mA 24V 15mA AC 10mA DC < 15mA AC < 10mA					
Standard detected object		6×6×1(A3 iron)	8×8×1(A3 iron)	8×8×1(A3 iron)	8×8×1(A3 iron)		
Repeated precision		0.01	0.01	0.01	0.01		
DC/AC		500Hz	500Hz	500Hz	500Hz/25Hz		
Working environment temperature		-25°C~+70°C	-25°C~+75°C	-25°C~+70°C	-25°C~+75°C		
Insulation resistance		50MΩ	≥30MΩ	50MΩ	≥50MΩ		
Shell material		Metal	Stainless steel	Metal	Metal		
Protection grade		IP67	IP67	IP67	IP67		
Alyemative model at home and abroad					E2E-X1R5□□		

PROXIMITY SWITCH

Structural category		Cylinder type					
Outward Appearance code		CZ LM12	CZ LM14	CZ LM18	CZ LM20		
Outward appearance illustration							
Overall dimensions							
DETECTION DISTANCE		2mm	3mm	5mm			
Flush	DC 10-30 VDC	NPN	NO	CZ LM12-3002NA	CZ LM14-3003NA	CZ LM18-3005NA	
			NC	CZ LM12-3002NB	CZ LM14-3003NB	CZ LM18-3005NB	
			NO+NC	CZ LM12-3002NC	CZ LM14-3003NC	CZ LM18-3005NC	
		PNP	NO	CZ LM12-3002PA	CZ LM14-3003PA	CZ LM18-3005PA	
			NC	CZ LM12-3002PB	CZ LM14-3003PB	CZ LM18-3005PB	
	two wire system	NO+NC	CZ LM12-3002PC	CZ LM14-3003PC	CZ LM18-3005PC		
		NO	CZ LM12-3002LA	CZ LM14-3003LA	CZ LM18-3005LA		
	AC 90-250 VAC	Control-lable silicon	NC	CZ LM12-2002LB	CZ LM14-3003LB	CZ LM18-3005LB	
			NO	CZ LM12-2002A	CZ LM14-2003A	CZ LM18-2005A	
			NC	CZ LM12-2002B	CZ LM14-2003B	CZ LM18-2005B	
Relay output				CZ LM18-2005C			
DETECTION DISTANCE		4mm	5mm	8mm	10mm		
Non-Flush	DC 10-30 VDC	NPN	NO	CZ LM12-3004NA	CZ LM14-3005NA	CZ LM18-3008NA	CZ LM20-3010NA
			NC	CZ LM12-3004NB	CZ LM14-3005NB	CZ LM18-3008NB	CZ LM20-3010NB
			NO+NC	CZ LM12-3004NC	CZ LM14-3005NC	CZ LM18-3008NC	CZ LM20-3010NC
		PNP	NO	CZ LM12-3004PA	CZ LM14-3005PA	CZ LM18-3008PA	CZ LM20-3010PA
			NC	CZ LM12-3004PB	CZ LM14-3005PB	CZ LM18-3008PB	CZ LM20-3010PB
	two wire system	NO+NC	CZ LM12-3004PC	CZ LM14-3005PC	CZ LM18-3008PC	CZ LM20-3010PC	
		NO	CZ LM12-3004LA	CZ LM14-3005LA	CZ LM18-3008LA	CZ LM20-3010LA	
	AC 90-250 VAC	Control-lable silicon	NC	CZ LM12-3004LB	CZ LM14-3005LB	CZ LM18-2008LB	CZ LM20-3010LB
			NO	CZ LM12-2004A	CZ LM14-2005A	CZ LM18-2008A	CZ LM20-2010A
			NC	CZ LM12-2004B	CZ LM14-2005B	CZ LM18-2008B	CZ LM20-2010B
Relay output				CZ LM18-2008C	CZ LM20-2010C		
Control output		DC	200mA	200mA	200mA	200mA	
		SCR/Relay	300mA	300mA	300mA	300mA/1A	
Output voltage drop DC/AC		(NPN PNP) 3V :3.9V AC 10V DC<3V AC < 10V					
Consumption current		(NPN PNP) DC 12V 8mA 24V 15mA AC 10mA DC<15mA AC<10mA					
Standard detected object		15×15×1(A3 iron)	15×15×1(A3 iron)	18×18×1(A3 iron)	20×20×1(A3 iron)		
Repeated precision		0.01	0.02	0.02	0.05		
DC/AC		400Hz/25Hz	300Hz/25Hz	200Hz/25Hz	200Hz/25Hz		
Working environment temperature		-25°C~+75°C	-25°C~+75°C	-25°C~+75°C	-25°C~+75°C		
Insulation resistance		≥50MΩ	≥50MΩ	50MΩ	50MΩ		
Shell material		Metal	Metal	Metal	ABS Resin		
Protection grade		IP67	IP67	IP67	IP67		
Alyemative model at home and abroad		E2E-X5□□	LJ14A3-□□	LJ18A3-8-□□			

PROXIMITY SWITCH

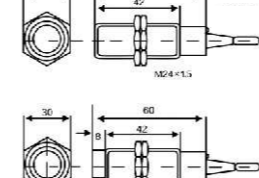
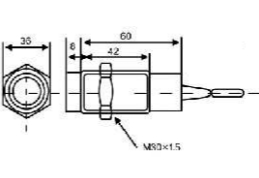
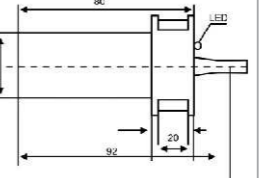
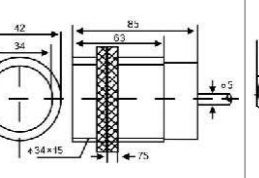
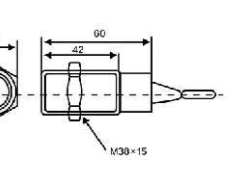
Structural category		Cylinder type						
Outward Appearance code		CZ LM24	CZ LM30	CZ LM34	CZ LM35	CZ LM38		
Outward appearance illustration								
Overall dimensions								
DETECTION DISTANCE		8mm	10mm	17mm	17mm	18mm		
Flush	DC 10-30 VDC	NPN	NO	CZ LM24-3008NA	CZ LM30-3010NA		CZ LM38-3012NA	
			NC	CZ LM24-3008NB	CZ LM30-3010NB		CZ LM38-3012NB	
			NO+NC	CZ LM24-3008NC	CZ LM30-3010NC		CZ LM38-3012NC	
		PNP	NO	CZ LM24-3008PA	CZ LM30-3010PA		CZ LM38-3012PA	
			NC	CZ LM24-3008PB	CZ LM30-3010PB		CZ LM38-3012PB	
	two wire system	NO+NC	CZ LM24-3008PC	CZ LM30-3010PC		CZ LM38-3012PC		
		NO	CZ LM24-3008LA	CZ LM30-3010LA		CZ LM38-3012LA		
	AC 90-250 VAC	Control-lable silicon	NC	CZ LM24-3008LB	CZ LM30-3010LB		CZ LM38-3012LB	
			NO	CZ LM24-2008A	CZ LM30-2010A		CZ LM38-2012A	
			NC	CZ LM24-2008B	CZ LM30-2010B		CZ LM38-2012B	
Relay output			CZ LM30-2010C			CZ LM38-2012C		
DETECTION DISTANCE		10mm	15mm	17mm	17mm	18mm		
Non-Flush	DC 10-30 VDC	NPN	NO	CZ LM24-3010NA	CZ LM30-3015NA	CZ LM34-3017NA	CZ LM35-3017NA	CZ LM38-3018NA
			NC	CZ LM24-3010NB	CZ LM30-3015NB	CZ LM34-3017NB	CZ LM35-3017NB	CZ LM38-3018NB
			NO+NC	CZ LM24-3010NC	CZ LM30-3015NC	CZ LM34-3017NC	CZ LM35-3017NC	CZ LM38-3018NC
		PNP	NO	CZ LM24-3010PA	CZ LM30-3015PA	CZ LM34-3017PA	CZ LM35-3017PA	CZ LM38-3018PA
			NC	CZ LM24-3010PB	CZ LM30-3015PB	CZ LM34-3017PB	CZ LM35-3017PB	CZ LM38-3018PB
	two wire system	NO+NC	CZ LM24-3010PC	CZ LM30-3015PC	CZ LM34-3017PC	CZ LM35-3017PC	CZ LM38-3018PC	
		NO	CZ LM24-3010LA	CZ LM30-3015LA	CZ LM34-3017LA	CZ LM35-3017LA	CZ LM38-3018LA	
	AC 90-250 VAC	Control-lable silicon	NC	CZ LM24-3010LB	CZ LM30-3015LB	CZ LM34-3017LB	CZ LM35-3017LB	LCZ M38-3018LB
			NO	CZ LM24-2010A	CZ LM30-2015A	CZ LM34-2017A	CZ LM35-2017A	CZ LM38-2018A
			NC	CZ LM24-2010B	CZ LM30-2015B	CZ LM34-2017B	CZ LM35-2017B	CZ LM38-2018B
Relay output			CZ LM30-2015C	CZ LM34-2017C	CZ LM35-2017C	CZ LM38-2018C		
Control output		DC	200mA	200mA	200mA	200mA		
		SCR/Relay	300mA	300mA/1A	300mA	200mA		
Output voltage drop DC/AC		(NPN PNP) 3V :3.9V AC 10V DC<3V AC < 10V						
Consumption current		(NPN PNP) DC 12V 8mA 24V 15mA AC 10mA DC<15mA AC<10mA						
Standard detected object		24×24×1(A3 iron)	30×30×1(A3 iron)	34×34×1(A3 iron)	40×40×1(A3 iron)	40×40×1(A3 iron)		
Repeated precision		0.05	0.05		0.1			
DC/AC		200Hz/25Hz	200Hz/25Hz		100Hz/15Hz			
Working environment temperature		-25°C~+75°C	-25°C~+75°C		-25°C~+75°C			
Insulation resistance		50MΩ	50MΩ		50MΩ			
Shell material		Metal	Metal	ABS Resin	ABS Resin	ABS Resin		
Protection grade		IP67	IP67		IP67			
Alyemative model at home and abroad		LJ24A3-10-□□	E2E-X18M□			LJ38A4-18-□□		

PROXIMITY SWITCH

Structural category Cylinder type

Outward Appearance code CZ LM39 CZ LM40 CZ LM480 CZ LM36

Outward appearance illustration



Overall dimensions

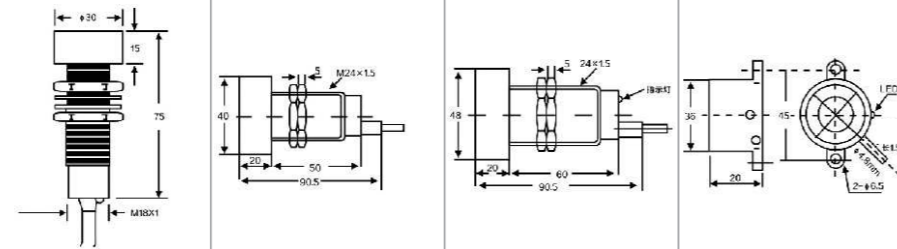

		DETECTION DISTANCE					
Flush	DC 10-30 VDC	NPN	NO				
			NC				
			NO+NC				
		PNP	NO				
			NC				
			NO+NC				
	AC 90-250 VAC	two wire system	NO				
			NC				
		SCR	NO				
		Control-lable silicon	NC				
Relay output							
		DETECTION DISTANCE					
Non-Flush	DC 10-30 VDC	NPN	NO	CZ LM39-3015NA	CZ LM40-3020NA	CZ LM480-3025NA	CZ LM36-3015NA
			NC	CZ LM39-3015NB	CZ LM40-3020NB	CZ LM480-3025NB	CZ LM36-3015NB
			NO+NC	CZ LM39-3015NC	CZ LM40-3020NC	CZ LM480-3025NC	CZ LM36-3015NC
		PNP	NO	CZ LM39-3015PA	CZ LM40-3002PA	CZ LM480-3025PA	CZ LM36-3015PA
			NC	CZ LM39-3015PB	CZ LM40-3002PB	CZ LM480-3025PB	CZ LM36-3015PB
			NO+NC	CZ LM39-3015PC	CZ LM40-3020PC	CZ LM480-3025PC	CZ LM36-3015PC
	AC 90-250 VAC	two wire system	NO	CZ LM39-3015LA	CZ LM40-3002LA	CZ LM480-3025LA	CZ LM36-3015LA
			NC	CZ LM39-3015LB	CZ LM40-3002LB	CZ LM480-3025LB	CZ LM36-2015LB
		SCR	NO	CZ LM39-2015A	CZ LM40-2002A	CZ LM480-2025A	CZ LM36-2015A
		Control-lable silicon	NC	CZ LM39-2015B	CZ LM40-2020B	CZ LM480-2025B	CZ LM36-2015B
Relay output				CZ LM40-2020JC			
Controloutput	DC		200mA	200mA	200mA	200mA	
	SCR/Relay		300mA/1A	300mA/1A		300mA	
Output voltage drop DC/AC		(NPN PNP) 3V :3.9V AC 10V DC<3V AC < 10V					
Consumption current		(NPN PNP) DC 12V 8mA 24V 15mA AC 10mA DC<15mA AC<10mA					
Standard detected object		45×45×1(A3 iron)	45×45×1(A3 iron)	50×50×1(A3 iron)	45×45×1(A3 iron)		
Repeated precision			0.1		0.05		
DC/AC			100Hz/25Hz		200Hz/10Hz		
Working environment temperature		-25°C~+75°C					
Insulation resistance		50MΩ					
Shell material		Metal	Metal	Metal	ABS Resin		
Protection grade		IP67					
Alyemative model at home and abroad		SC-□□	SC-□□	SFE-□□			

PROXIMITY SWITCH

Plane installation type Angular column type

CZ LM42 CZ LM48 CZ LM55 CZ LMF1 CZ LMF2

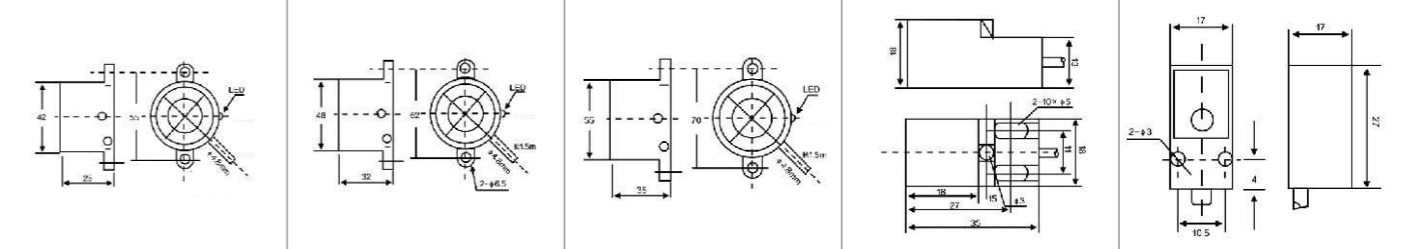

		5mm		5mm	
Flush	DC 10-30 VDC	NPN	CZ LMF1-3005NA	CZ LMF2-3005NA	
			CZ LMF1-3005NB	CZ LMF2-3005NB	
		PNP	CZ LMF1-3005PA	CZ LMF2-3005PA	
			CZ LMF1-3005PB	CZ LMF2-3005PB	
	AC 90-250 VAC	two wire system	CZ LMF1-3005LA	CZ LMF2-3005LA	
			CZ LMF1-3005LB	CZ LMF2-3005LB	
		SCR			
		Control-lable silicon			
Relay output					
		20mm		25mm	
Non-Flush	DC 10-30 VDC	NPN	CZ LM42-3020NA	CZ LM48-3020NA	CZ LM55-3025NA
			CZ LM42-3020NB	CZ LM48-3020NB	CZ LM55-3025NB
			CZ LM42-3020NC	CZ LM48-3020NC	CZ LM55-3025NC
		PNP	CZ LM42-3020PA	CZ LM48-3020PA	CZ LM55-3025PA
			CZ LM42-3020PB	CZ LM48-3020PB	CZ LM55-3025PB
			CZ LM42-3020PC	CZ LM48-3020PC	CZ LM55-3025PC
	AC 90-250 VAC	two wire system	CZ LM42-3020LA	CZ LM48-3020LA	CZ LM55-3025LA
			CZ LM42-2020LB	CZ LM48-2020LB	CZ LM55-2025LB
		SCR	CZ LM42-2020A	CZ LM48-2020A	CZ LM55-2025A
		Control-lable silicon	CZ LM42-2020B	CZ LM48-2020B	CZ LM55-2025B
Relay output			CZ LM48-2020C	CZ LM55-2025C	
		200mA		200mA	
Controloutput	DC	200mA	200mA	200mA	200mA
	SCR/Relay	300mA	300mA	300mA	300mA
Output voltage drop DC/AC		(NPN PNP) 3V :3.9V AC 10V DC<3V AC < 10V			
Consumption current		(NPN PNP) DC 12V 8mA 24V 15mA AC 10mA DC<15mA AC<10mA			
Standard detected object		25×25×1(A3 iron)	60×60×1(A3 iron)	55×55×1(A3 iron)	20×20×1(A3 iron)
Repeated precision		0.2	0.2	0.2	0.02
DC/AC		200Hz/10Hz	200Hz/10Hz	200Hz/10Hz	400Hz/25Hz
Working environment temperature		-25°C~+75°C	-25°C~+75°C	-25°C~+75°C	-25°C~+75°C
Insulation resistance		50MΩ	50MΩ	50MΩ	50MΩ
Shell material		ABS Resin	ABS Resin	ABS Resin	ABS Resin
Protection grade		IP67	IP67	IP67	IP67
Alyemative model at home and abroad			SD-□□	SE-□□	SN04-N
					TL-Q5MC1

PROXIMITY SWITCH

Structural category Angular column type

Outward Appearance code CZ LMF3 CZ LMF4 CZ LMF5 CZ LMF6

Outward appearance illustration

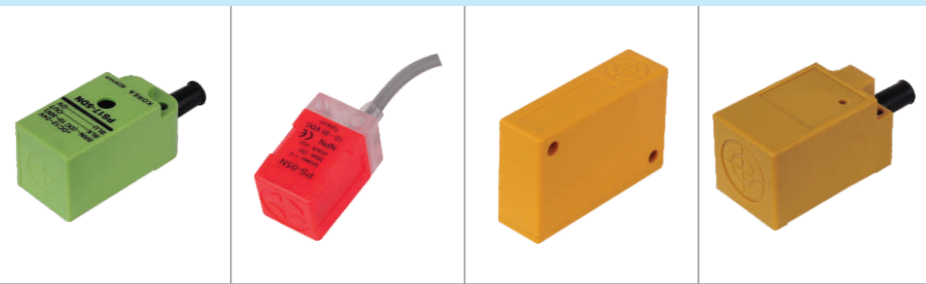

Overall dimensions

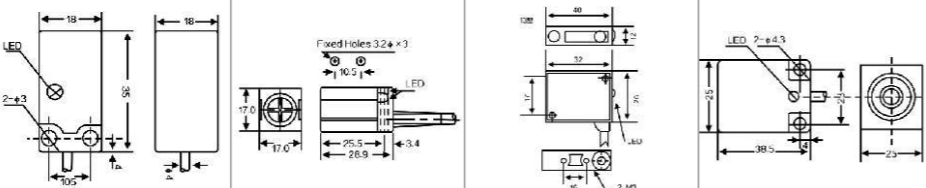

		DETECTION DISTANCE		5mm	5mm	2mm	8mm
Flush	DC 10-30 VDC	NPN	NO	CZ LMF3-3005NA	CZ LMF4-3005NA	CZ LMF5-3002NA	CZ LMF6-3008NA
			NC	CZ LMF3-3005NB	CZ LMF4-3005NB	CZ LMF5-3002NB	CZ LMF6-3008NB
			NO+NC	CZ LMF4-3005NC	CZ LMF5-3002NC	CZ LMF6-3008NC	
		PNP	NO	CZ LMF3-3005PA	CZ LMF4-3005PA	CZ LMF5-3002PA	CZ LMF6-3008PA
			NC	CZ LMF3-3005PB	CZ LMF4-3005PB	CZ LMF5-3002PB	CZ LMF6-3008PB
			NO+NC	CZ LMF4-3005PC	CZ LMF5-3002PC	CZ LMF6-3008PC	
	AC 90-250 VAC	two wire system	NO	CZ LMF3-3005LA	CZ LMF4-3005LA	CZ LMF5-3002LA	CZ LMF6-3008LA
		NC	CZ LMF3-3005LB	CZ LMF4-3005LB	CZ LMF5-3002LB	CZ LMF6-3008LB	
		SCR	NO			CZ LMF6-2008A	
		Control-lable silicon	NC			CZ LMF6-2008B	
Relay output							
Non-Flush	DC 10-30 VDC	NPN	NO			CZ LMF5-3004NA	CZ LMF6-3010NA
			NC			CZ LMF5-3004NB	CZ LMF6-3010NB
			NO+NC			CZ LMF5-3004NC	CZ LMF6-3010NC
		PNP	NO			CZ LMF5-3004PA	CZ LMF6-3010PA
			NC			CZ LMF5-3004PB	CZ LMF6-3010PB
			NO+NC			CZ LMF5-3004PC	CZ LMF6-3010PC
	AC 90-250 VAC	two wire system	NO			CZ LMF5-3004LA	CZ LMF6-3010LA
		NC			CZ LMF5-3004LB	CZ LMF6-3010LB	
		SCR	NO	CZ LMF3-2005A		CZ LMF6-2010A	
		Control-lable silicon	NC	CZ LMF3-2005B		CZ LMF6-2010B	
Relay output							
Control output	DC		200mA	200mA	200mA	200mA	
	SCR/Relay			300mA/1A		300mA	
Output voltage drop DC/AC		NPN PNP) 3V :3.9V AC 10V DC <3V AC <10V					
Consumption current		(NPN PNP) DC 12V 8mA 24V 15mA AC 10mA DC <15mA AC <10mA					
Standard detected object		20×20×1(A3 iron)	20×20×1(A3 iron)	15×15×1(A3 iron)	30×30×1(A3 iron)		
Repeated precision		0.02	0.03	0.03	0.05		
DC/AC		400Hz/25Hz	300Hz	400Hz	200Hz/10Hz		
Working environment temperature		-25°C~+75°C	-25°C~+75°C	-25°C~+75°C			
Insulation resistance		50MΩ	50MΩ	50MΩ			
Shell material		ABS Resin	ABS Resin	ABS Resin	ABS Resin		
Protection grade		IP67	IP67	IP67			
Alyemative model at home and abroad		PS17-5PN	PS05-N PS05-P	TL-N5ME□□			

PROXIMITY SWITCH



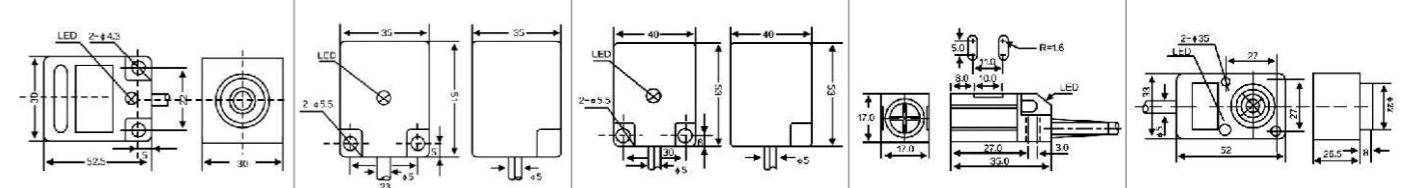

Angular column type

CZ LMF7 CZ LMF8 CZ LMF10 CZ LMF11 CZ LMF12





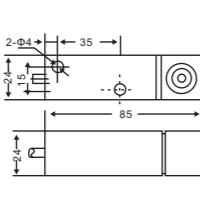
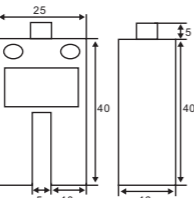
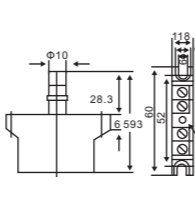
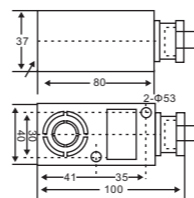

		10mm	10mm	15mm	5mm				
Flush	DC 10-30 VDC	NO	CZ LMF7-3010NA	CZ LMF8-3010NA	CZ LMF10-3015NA				
		NC	CZ LMF7-3010NB	CZ LMF8-3010NB	CZ LMF10-3015NB				
		NO+NC			CZ LMF10-3015NC				
		PNP	NO	CZ LMF7-3010PA	CZ LMF8-3010PA	CZ LMF10-3015PA			
			NC	CZ LMF7-3010PB	CZ LMF8-3010PB	CZ LMF10-3015PB			
			NO+NC	CZ LMF7-3010PC	CZ LMF8-3010PC	CZ LMF10-3015PC			
	AC 90-250 VAC	two wire system	NO	CZ LMF7-3010LA	CZ LMF8-3010LA	CZ LMF10-3015LA			
		NC	CZ LMF7-3010LB	CZ LMF8-3010LB	CZ LMF10-3015LB				
		SCR	NO			CZ LMF10-2015A			
		Control-lable silicon	NC			CZ LMF10-2015B			
Relay output									
Non-Flush	DC 10-30 VDC	NPN	NO			CZ LMF7-3015NA	CZ LMF8-3015NA	CZ LMF10-3020NA	
			NC			CZ LMF7-3015NB	CZ LMF8-3015NB	CZ LMF10-3020NB	
			NO+NC			CZ LMF7-3015NC	CZ LMF8-3015NC	CZ LMF10-3020NC	
		PNP	NO			CZ LMF7-3015PA	CZ LMF8-3015PA	CZ LMF10-3020PA	
			NC			CZ LMF7-3015PB	CZ LMF8-3015PB	CZ LMF10-3020PB	
			NO+NC			CZ LMF7-3015PC	CZ LMF8-3015PC	CZ LMF10-3020PC	
	AC 90-250 VAC	two wire system	NO			CZ LMF7-3015LA	CZ LMF8-3015LA	CZ LMF10-3020LA	
		NC			CZ LMF7-3015LB	CZ LMF8-3015LB	CZ LMF10-3020LB		
		SCR	NO			CZ LMF7-2015A	CZ LMF8-2015A	CZ LMF10-2020A	
		Control-lable silicon	NC			CZ LMF7-2015B	CZ LMF8-2015B	CZ LMF10-2020B	
Relay output									
Control output	DC		200mA	200mA	200mA	200mA	200mA		
	SCR/Relay			300mA		500mA		500mA	
Output voltage drop DC/AC		(NPN PNP) 3V :3.9V AC 10V DC <3V AC <10V							
Consumption current		(NPN PNP) DC 12V 8mA 24V 15mA AC 10mA DC <15mA AC <10mA							
Standard detected object		35×35×1(A3 iron)	40×40×1(A3 iron)	45×45×1(A3 iron)	20×20×1(A3 iron)	25×25×1(A3 iron)			
Repeated precision		0.05	0.05	0.05	0.05	0.04			
DC/AC		200Hz/15Hz	200Hz/15Hz	100Hz/15Hz	500Hz	200Hz/15Hz			
Working environment temperature		-25°C~+75°C	-25°C~+75°C	-25°C~+70°C	-25°C~+70°C	-25°C~+70°C			
Insulation resistance		50MΩ	50MΩ	50MΩ	50MΩ	50MΩ			
Shell material		ABS Resin	ABS Resin	ABS Resin	ABS Resin	ABS Resin			
Protection grade		IP67	IP67	IP67	IP67	IP67			
Alyemative model at home and abroad		TL-N10M		TL-N20M□	PL-05N PL-05P	LJ1A-24			



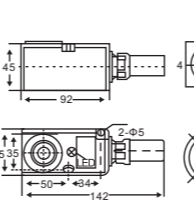
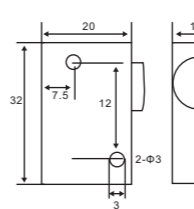
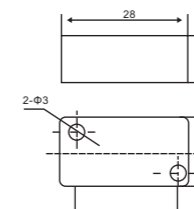
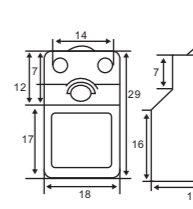
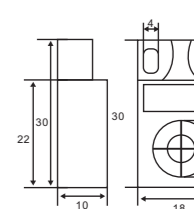

PROXIMITY SWITCH

Structural category		Angular column type					
Outward Appearance code		CZ LMF13	CZ LMF14	CZ LMF15	CZ LMF16		
Outward appearance illustration							
Overall dimensions							
DETECTION DISTANCE		2mm					
Flush	DC 10-30 VDC	NPN	NO		CZ LMF15-3002NA		
			NC		CZ LMF15-3002NB		
			NO+NC		CZ LMF15-3002NC		
		PNP	NO		CZ LMF15-3002PA		
			NC		CZ LMF15-3002PB		
			NO+NC		CZ LMF15-3002PC		
	two wire system	NO		CZ LMF15-3002LA			
		NC		CZ LMF15-3002LB			
	AC 90-250 VAC	SCR	NO		CZ LMF15-2002A		
		Control-silicon	NC		CZ LMF15-2002B		
Relay output							
DETECTION DISTANCE		8mm	5mm	4mm	15mm		
Non-Flush	DC 10-30 VDC	NPN	NO	CZ LMF13-3008NA	CZ LMF14-3005NA	CZ LMF15-3004NA	CZ LMF16-3015NA
			NC	CZ LMF13-3008NB	CZ LMF14-3005NB	CZ LMF15-3004NB	CZ LMF16-3015NB
			NO+NC	CZ LMF13-3008NC	CZ LMF14-3005NC	CZ LMF15-3004NC	CZ LMF16-3015NC
		PNP	NO	CZ LMF13-3008PA	CZ LMF14-3005PA	CZ LMF15-3004PA	CZ LMF16-3015PA
			NC	CZ LMF13-3008PB	CZ LMF14-3005PB	CZ LMF15-3004PB	CZ LMF16-3015PB
			NO+NC	CZ LMF13-3008PC	CZ LMF14-3005PC	CZ LMF15-3004PC	CZ LMF16-3015PC
	two wire system	NO	CZ LMF13-3008LA	CZ LMF14-3005LA	CZ LMF15-3004LA	CZ LMF16-3015LA	
		NC	CZ LMF13-3008LB	CZ LMF14-3005LB	CZ LMF15-3004LB	CZ LMF16-3015LB	
	AC 90-250 VAC	SCR	NO	CZ LMF13-2008A	CZ LMF14-2005A	CZ LMF15-2004A	CZ LMF16-2015A
		Control-silicon	NC	CZ LMF13-2008B	CZ LMF14-2005B	CZ LMF15-2004B	CZ LMF16-2015B
Relay output					CZ LMF16-2015C		
Controloutput	DC	200mA	200mA	200mA	200mA		
	SCR/Relay	300mA/1A					
Output voltage drop DC/AC		(NPN PNP) 3V以下、二线型:3.9V以下、交流AC 10V以下 DC<3V、 AC<10V					
Consumption current		直流(NPN PNP)型DC 12V时8mA、24V时15mA、交流AC 10mA以下 DC<15mA、AC<10mA					
Standard detected object		25×25×1(A3铁iron)	18×18×1(A3铁iron)	15×15×1(A3铁iron)	45×45×1(A3铁iron)		
Repeated precision		0.04	0.05	0.02	0.05		
DC/AC		200Hz/15Hz	500Hz/10Hz		100Hz/Hz		
Working environment temperature		-25°C~+70°C					
Insulation resistance		50MΩ					
Shell material		ABS树脂 Resin	ABS塑料 Plastil				
Protection grade		IP67	IP67				
Alyemative model at home and abroad		LJD-□□		ST-F-□	LJ2-□□/□□□		



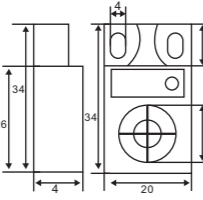
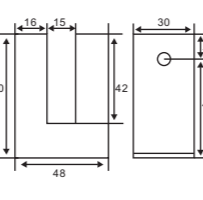
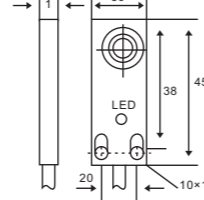
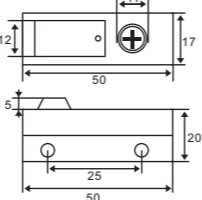

PROXIMITY SWITCH

Angular column type		Plane installation type						
Outward Appearance code		CZ LMF17	CZ LMF21	CZ LMF22	CZ LMF23	CZ LMF24		
Outward appearance illustration								
Overall dimensions								
DETECTION DISTANCE		4mm	2mm	4mm	4mm	4mm		
Flush	DC 10-30 VDC	NPN	NO		CZ LMF22-3002NA			
			NC		CZ LMF22-3002NB			
			NO+NC					
		PNP	NO		CZ LMF22-3002PA			
			NC		CZ LMF22-3002PB			
			NO+NC					
	two wire system	NO		CZ LMF22-3002LA				
		NC		CZ LMF22-3002LB				
	AC 90-250 VAC	SCR	NO					
		Control-silicon	NC					
Relay output								
DETECTION DISTANCE		20mm	4mm	4mm	5mm	5mm		
Non-Flush	DC 10-30 VDC	NPN	NO	CZ LMF17-3020NA	CZ LMF21-3004NA	CZ LMF22-3004NA	CZ LMF23-3005NA	CZ LMF24-3005NA
			NC	CZ LMF17-3020NB	CZ LMF21-3004NB	CZ LMF22-3004NB	CZ LMF23-3005NB	CZ LMF24-3005NB
			NO+NC	CZ LMF17-3020NC	CZ LMF21-3004NC	CZ LMF22-3004NC	CZ LMF23-3005NC	CZ LMF24-3005NC
		PNP	NO	CZ LMF17-3020PA	CZ LMF21-3004PA	CZ LMF22-3004PA	CZ LMF23-3005PA	CZ LMF24-3005PA
			NC	CZ LMF17-3020PB	CZ LMF21-3004PB	CZ LMF22-3004PB	CZ LMF23-3005PB	CZ LMF24-3005PB
			NO+NC	CZ LMF17-3020PC	CZ LMF21-3004PC	CZ LMF22-3004PC	CZ LMF23-3005PC	CZ LMF24-3005PC
	two wire system	NO	CZ LMF17-3020LA	CZ LMF21-3004LA	CZ LMF22-3004LA	CZ LMF23-3005LA	CZ LMF24-3005LA	
		NC	CZ LMF17-3020LB	CZ LMF21-3004LB	CZ LMF22-3004LB	CZ LMF23-3005LB	CZ LMF24-3005LB	
	AC 90-250 VAC	SCR	NO	CZ LMF17-2020A				
		Control-silicon	NC	CZ LMF17-2020B				
Relay output		CZ LMF17-2020C						
Controloutput		200mA	200mA	200mA	200mA	200mA		
Output voltage drop DC/AC		(NPN PNP) 3V :3.9V AC 10V DC<3V AC <10V						
Consumption current		(NPN PNP) DC 12V 8mA 24V 15mA AC 10mA DC<15mA AC<10mA						
Standard detected object		50×50×1(A3 iron)	12×12×1(A3 iron)	15×15×1(A3 iron)	20×20×1(A3 iron)	12×12×1(A3 iron)		
Repeated precision		0.2	0.01	0.05	0.05	0.05		
DC/AC		200Hz/15Hz	500Hz/5Hz	300Hz	500Hz	500Hz/5Hz		
Working environment temperature		-25°C~+70°C						
Insulation resistance		≥50MΩ	50MΩ	≥50MΩ	50MΩ	50MΩ		
Shell material		ABS Resin		ABS Resin	ABS Plastil	ABS Plastil		
Protection grade		IP67	IP67	IP67	IP67	IP67		

PROXIMITY SWITCH

Structural category		Plane installation type		Angular column type				
Outward Appearance code		CZ LMF25	CZ LMF27	CZ LMF29	CZ LMF30			
Outward appearance illustration								
Overall dimensions								
DETECTION DISTANCE		5mm						
Flush	DC 10-30 VDC	NPN	NO		CZ LMF29-3005NA			
			NC		CZ LMF29-3005NB			
			NO+NC		CZ LMF29-3005NC			
		PNP	NO		CZ LMF29-3005PA			
			NC		CZ LMF29-3005PB			
			NO+NC		CZ LMF29-3005PC			
	two wire system	NO		CZ LMF29-3005LA				
	NC							
	AC 90-250 VAC	SCR	NO		CZ LMF29-2005A			
		Control-silicon	NC		CZ LMF29-2005B			
NO+NC								
Relay output								
DETECTION DISTANCE		5mm	15mm	8mm	4mm			
Non-Flush	DC 10-30 VDC	NPN	NO	CZ LMF25-3005NA	CZ LMF27-3015NA	CZ LMF29-3008NA	CZ LMF30-3004NA	
			NC	CZ LMF25-3005NB	CZ LMF27-3015NB	CZ LMF29-3008NB	CZ LMF30-3004NB	
			NO+NC	CZ LMF25-3005NC	CZ LMF27-3015NC	CZ LMF29-3008NC	CZ LMF30-3004NC	
			PNP	NO	CZ LMF25-3005PA	CZ LMF27-3015PA	CZ LMF29-3008PA	CZ LMF30-3004PA
				NC	CZ LMF25-3005PB	CZ LMF27-3015PB	CZ LMF29-3008PB	CZ LMF30-3004PB
				NO+NC	CZ LMF25-3005PC	CZ LMF27-3015PC	CZ LMF29-3008PC	CZ LMF30-3004PC
		two wire system	NO	CZ LMF25-3005LA	CZ LMF27-3015LA	CZ LMF29-3008LA	CZ LMF30-3004LA	
		NC	CZ LMF25-3005LB		CZ LMF29-3008LB			
		AC 90-250 VAC	SCR	NO	CZ LMF25-2005A	CZ LMF27-2015A	CZ LMF29-2008A	CZ LMF30-2004A
			Control-silicon	NC	CZ LMF25-2005B	CZ LMF27-2015B	CZ LMF29-2008B	CZ LMF30-2004B
				NO+NC				
				Relay output				
	Control output	DC	200mA	200mA	200mA	200mA		
	SCR/Relay	500mA	300mA	300mA	300mA			
	Output voltage drop DC/AC		(NPN PNP) 3V :3.9V AC 10V DC<3V AC < 10V					
	Consumption current		(NPN PNP) DC 12V 8mA 24V 15mA AC 10mA DC<15mA AC<10mA					
Standard detected object		18×18×1(A3 iron)	30×30×1(A3 iron)	25×25×1(A3 iron)	15×15×1(A3 iron)			
Repeated precision		0.05	0.05	0.05	0.05			
DC/AC		500Hz/10Hz	300Hz/10Hz	300Hz	300Hz/10Hz			
Working environment temperature		-25°C~+70°C	-25°C~+70°C	-25°C~+70°C	-25°C~+70°C			
Insulation resistance		50MΩ	50MΩ	50MΩ	50MΩ			
Shell material		ABS Plastil		ABS Resin				
Protection grade		IP67	IP67	IP67	IP67			
Alyemative model at home and abroad								

PROXIMITY SWITCH

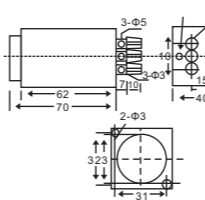
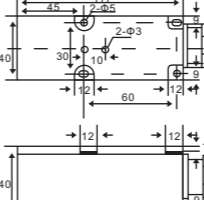
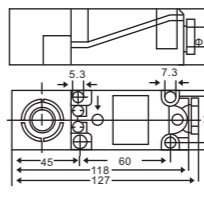
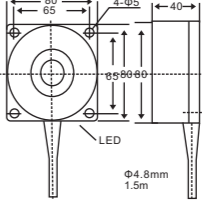
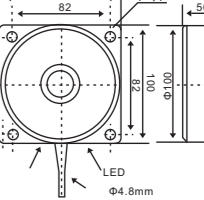
Angular column type		Plane installation type							
Outward Appearance code		CZ LMF35	CZ LMF36	CZ LMF37	CZ LMF38	CZ LMF39			
Outward appearance illustration									
Overall dimensions									
DETECTION DISTANCE		15mm							
Flush	DC 10-30 VDC	NPN	NO		CZ LMF37-3015NA				
			NC		CZ LMF37-3015NB				
			NO+NC		CZ LMF37-3015NC				
			PNP	NO		CZ LMF37-3015PA			
				NC		CZ LMF37-3015PB			
				NO+NC		CZ LMF37-3015PC			
		two wire system	NO		CZ LMF37-3015LA				
		NC							
		AC 90-250 VAC	SCR	NO		CZ LMF37-2015A			
			Control-silicon	NC		CZ LMF37-2015B			
				NO+NC			CZ LMF37-2015C		
				Relay output					
	DETECTION DISTANCE		15mm	1-20mm	20mm	1-40mm	1-50mm		
	Non-Flush	DC 10-30 VDC	NPN	NO	CZ LMF35-3015NA	CZ LMF36-3020NA	CZ LMF37-3020NA	CZ LMF38-3040NA	CZ LMF39-3050NA
				NC	CZ LMF35-3015NB	CZ LMF36-3020NB	CZ LMF37-3020NB	CZ LMF38-3040NB	CZ LMF39-3050NB
				NO+NC	CZ LMF35-3015NC	CZ LMF36-3020NC	CZ LMF37-3020NC	CZ LMF38-3040NC	CZ LMF39-3050NC
PNP				NO	CZ LMF35-3015PA	CZ LMF36-3020PA	CZ LMF37-3020PA	CZ LMF38-3040PA	CZ LMF39-3050PA
				NC	CZ LMF35-3015PB	CZ LMF36-3020PB	CZ LMF37-3020PB	CZ LMF38-3040PB	CZ LMF39-3050PB
				NO+NC	CZ LMF35-3015PC	CZ LMF36-3020PC	CZ LMF37-3020PC	CZ LMF38-3040PC	CZ LMF39-3050PC
two wire system			NO	CZ LMF35-3015LA	CZ LMF36-3020LA	CZ LMF37-3020LA	CZ LMF38-3040LA	CZ LMF39-3050LA	
NC			CZ LMF35-3015LB	CZ LMF36-3020LB	CZ LMF37-3020LB	CZ LMF38-3040LB	CZ LMF39-3050LB		
AC 90-250 VAC			SCR	NO	CZ LMF35-2015A	CZ LMF36-2020A	CZ LMF37-2020A	CZ LMF38-2040A	CZ LMF39-2050A
			Control-silicon	NC	CZ LMF35-2015B	CZ LMF36-2020B	CZ LMF37-2020B	CZ LMF38-2040B	CZ LMF39-2050B
				NO+NC					
				Relay output					
Control output		DC	200mA	200mA	200mA	200mA	200mA		
SCR/Relay		500mA	300mA/2A	300mA/2A	300mA/2A	300mA/2A			
Output voltage drop DC/AC		(NPN PNP) 3V :3.9V AC 10V DC<3V AC < 10V							
Consumption current		(NPN PNP) DC 12V 8mA 24V 15mA AC 10mA DC<15mA AC<10mA							
Standard detected object		40×40×1(A3 iron)	50×50×1(A3 iron)	50×50×1(A3 iron)	100×100×1(A3 iron)	120×120×1(A3 iron)			
Repeated precision		0.05	0.2	0.2	0.5	0.5			
DC/AC		200Hz/15Hz	500Hz/15Hz	200Hz/15Hz	50Hz/10Hz	50Hz/10Hz			
Working environment temperature		-25°C~+70°C	-25°C~+70°C	-25°C~+70°C	-25°C~+75°C	-25°C~+75°C			
Insulation resistance		≥50MΩ	50MΩ	≥50MΩ	50MΩ	50MΩ			
Shell material		ABS Resin	ABS Resin	ABS Resin					
Protection grade		IP67	IP67	IP67	IP67	IP67			
Alyemative model at home and abroad		JDK-2正負		HY-A20□	TCD-2040□	TCD-2050□			

PROXIMITY SWITCH

Structural category Plane installation type

Outward Appearance code CZ LMF40 CZ LMF41 CZ LMF42 CZ LMF43

Outward appearance illustration

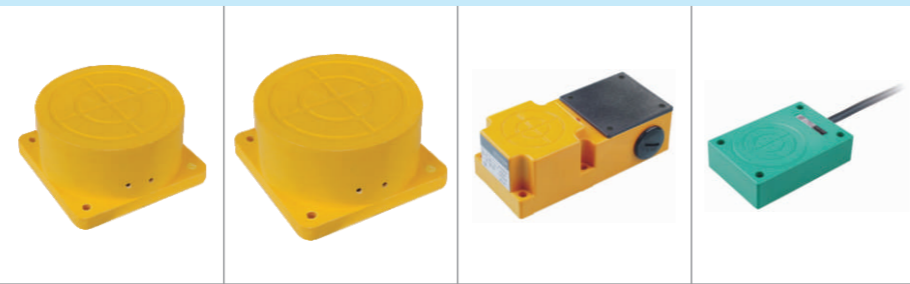

Overall dimensions

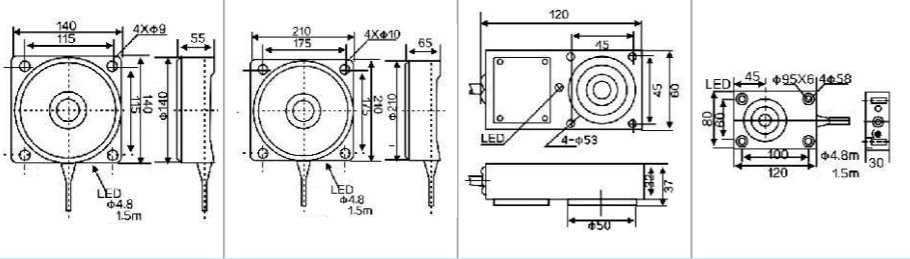

		DETECTION DISTANCE							
Flush	DC 10-30 VDC	NPN	NO						
			NC						
			NO+NC						
		PNP	NO						
			NC						
	two wire system	NO							
		NC							
	AC 90-250 VAC	Control-able silicon	SCR	NO					
			NC						
			NO+NC						
Relay output									
		DETECTION DISTANCE							
Non-Flush	DC 10-30 VDC	NPN	NO	CZ LMF40-3080NA	CZ LMF41-30120NA	CZ LMF42-3025NA	CZ LMF43-3040NA		
			NC	CZ LMF40-3080NB	CZ LMF41-30120NB	CZ LMF42-3025NB	CZ LMF43-3040NB		
			NO+NC	CZ LMF40-3080NC	CZ LMF41-30120NC	CZ LMF42-3025NC	CZ LMF43-3040NC		
		PNP	NO	CZ LMF40-3080PA	CZ LMF41-30120PA	CZ LMF42-3025PA	CZ LMF43-3040PA		
			NC	CZ LMF40-3080PB	CZ LMF41-30120PB	CZ LMF42-3025PB	CZ LMF43-3040PB		
			NO+NC	CZ LMF40-3080PC	CZ LMF41-30120PC	CZ LMF42-3025PC	CZ LMF43-3040PC		
		two wire system	NO	CZ LMF40-3080LA	CZ LMF41-30120LA	CZ LMF42-3025LA	CZ LMF43-3040LA		
			NC	CZ LMF40-3080LB	CZ LMF41-30120LB	CZ LMF42-3025LB	CZ LMF43-3040LB		
		AC 90-250 VAC	Control-able silicon	SCR	NO	CZ LMF40-2080A	CZ LMF41-20120A	CZ LMF42-2025A	CZ LMF43-2040A
				NC	CZ LMF40-2080B	CZ LMF41-20120B	CZ LMF42-2025B	CZ LMF43-2040B	
	NO+NC			CZ LMF40-2080C	CZ LMF41-20120C	CZ LMF42-2025C	CZ LMF43-2040C		
	Relay output			CZ LMF40-2080JC	CZ LMF41-20120JC	CZ LMF42-2025JC	CZ LMF43-2040JC		
	Control output	DC		200mA	200mA	200mA	200mA		
		SCR/ Relay		300mA/3A	300mA/5A	300mA/2A	300mA/2A		
	Output voltage drop DC/AC		(NPN PNP) 3V :3.9V AC 10V DC<3V AC <10V						
Consumption current		(NPN PNP) DC 12V 8mA 24V 15mA AC 10mA DC<15mA AC<10mA							
Standard detected object		160×160×1(A3 iron)	250×250×1(A3 iron)	80×80×1(A3 iron)	100×100×1(A3 iron)				
Repeated precision		0.5	0.5	0.05	0.05				
DC/AC		10Hz/5Hz	10Hz/5Hz	50Hz/10Hz	30Hz/10Hz				
Working environment temperature		-25°C~+75°C	-25°C~+75°C	-25°C~+70°C	-25°C~+70°C				
Insulation resistance		50MΩ	50MΩ	50MΩ	50MΩ				
Shell material				ABS Resin	ABS Resin				
Protection grade		IP67	IP67	IP65	IP65				
Alyemative model at home and abroad		TCB-2080□	TCC-2120□						

PROXIMITY SWITCH

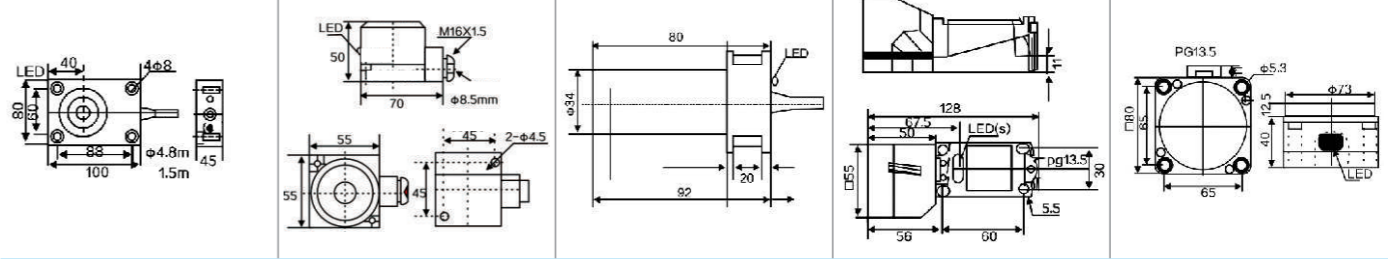

Plane installation type

CZ LMF45 CZ LMF55 CZ LMF340 CZ LMF370 CZ LMF380



		DETECTION DISTANCE								
Flush	DC 10-30 VDC	NPN	NO							
			NC							
			NO+NC							
		PNP	NO							
			NC							
	two wire system	NO								
		NC								
	AC 90-250 VAC	Control-able silicon	SCR	NO						
			NC							
			NO+NC							
Relay output										
		DETECTION DISTANCE								
Non-Flush	DC 10-30 VDC	NPN	NO	CZ LMF45-3050NA	CZ LMF55-3025NA	CZ LMF340-3020NA	CZ LMF370-3040NA	CZ LMF380-3040NA		
			NC	CZ LMF45-3050NB	CZ LMF55-3025NB	CZ LMF340-3020NB	CZ LMF370-3040NB	CZ LMF380-3040NB		
			NO+NC	CZ LMF45-3050NC	CZ LMF55-3025NC	CZ LMF340-3020NC	CZ LMF370-3040NC	CZ LMF380-3040NC		
		PNP	NO	CZ LMF45-3050PA	CZ LMF55-3025PA	CZ LMF340-3020PA	CZ LMF370-3040PA	CZ LMF380-3040PA		
			NC	CZ LMF45-3050PB	CZ LMF55-3025PB	CZ LMF340-3020PB	CZ LMF370-3040PB	CZ LMF380-3040PB		
			NO+NC	CZ LMF45-3050PC	CZ LMF55-3025PC	CZ LMF340-3020PC	CZ LMF370-3040PC	CZ LMF380-3040PC		
		two wire system	NO	CZ LMF45-3050LA	CZ LMF55-3025LA	CZ LMF340-3020LA	CZ LMF370-3040LA	CZ LMF380-3040LA		
			NC	CZ LMF45-3050LB	CZ LMF55-3025LB	CZ LMF340-3020LB	CZ LMF370-3040LB	CZ LMF380-3040LB		
		AC 90-250 VAC	Control-able silicon	SCR	NO	CZ LMF45-2050A	CZ LMF55-2025A	CZ LMF340-2020A	CZ LMF370-2040A	CZ LMF380-2040A
				NC	CZ LMF45-2050B	CZ LMF55-2025B	CZ LMF340-2020B	CZ LMF370-2040B	CZ LMF380-2040B	
	NO+NC			CZ LMF45-2050C	CZ LMF55-2025C	CZ LMF340-2020C	CZ LMF370-2040C	CZ LMF380-2040C		
	Relay output									
	Control output	DC		200mA	200mA	200mA	200mA	200mA		
		SCR/ Relay		500mA	300mA/2A	300mA	500mA	500mA		
	Output voltage drop DC/AC		(NPN PNP) 3V :3.9V AC 10V DC<3V AC <10V							
Consumption current		(NPN PNP) DC 12V 8mA 24V 15mA AC 10mA DC<15mA AC<10mA								
Standard detected object		80×80×1(A3 iron)	70×70×1(A3 iron)	35×35×1(A3 iron)	55×55×1(A3 iron)	50×50×1(A3 iron)				
Repeated precision		0.5	0.2	0.05	0.5	0.05				
DC/AC		200Hz/5Hz	200Hz/10Hz	300Hz/10Hz	200Hz/10Hz	500Hz/10Hz				
Working environment temperature		-25°C~+70°C	-25°C~+70°C	-25°C~+70°C	-25°C~+70°C	-25°C~+70°C				
Insulation resistance		50MΩ	50MΩ	50MΩ	50MΩ	50MΩ				
Shell material		Plastil	ABS Resin		Plastil	ABC Plastil				
Protection grade		IP67	IP67	IP67	IP67	IP67				
Alyemative model at home and abroad			HE-/HD-			NJ40P-FP-A2-P1				

STRAIGHT CONNECTOR SWITCH

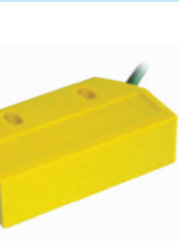
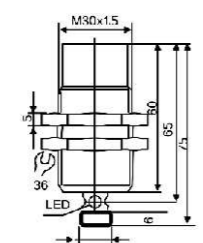
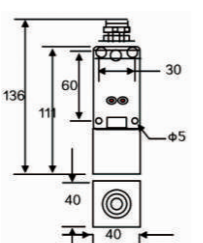
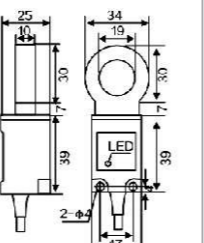
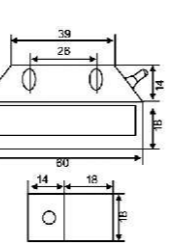
Structural category		Connector type						
Outward Appearance code		CZ LM30-□T/LM30-□T3	CZ LMF31	CZ LMF32	CZ LMF33			
Outward appearance illustration								
Overall dimensions								
DETECTION DISTANCE		10mm	15mm	20mm	5mm			
Flush	DC 6-36 VDC	NPN	NO	CZ LM30-3010NAT	CZ LMF31-3015NA	CZ LMF32-3020NA	CZ LMF33-3005NA	
			NC	CZ LM30-3010NBT	CZ LMF31-3015NB	CZ LMF32-3020NB	CZ LMF33-3005NB	
			NO+NC	CZ LM30-3010NCT	CZ LMF31-3015NC	CZ LMF32-3020NC	CZ LMF33-3005NC	
		PNP	NO	CZ LM30-3010PAT	CZ LMF31-3015PA	CZ LMF32-3020PA	CZ LMF33-3005PA	
			NC	CZ LM30-3010PBT	CZ LMF31-3015PB	CZ LMF32-3020PB	CZ LMF33-3005PB	
	two wire system	NO+NC	CZ LM30-3010PCT	CZ LMF31-3015PC	CZ LMF32-3020PC	CZ LMF33-3005PC		
		NO	CZ LM30-3010LAT	CZ LMF31-3015LA	CZ LMF32-3020LA	CZ LMF33-3005LA		
		NC	CZ LM30-3010LBT	CZ LMF31-3015LB	CZ LMF32-3020LB	CZ LMF33-3005LB		
		AC 90-250 VAC	SCR	NO	CZ LM30-2010AT	CZ LMF31-2015A	CZ LMF32-2020A	CZ LMF33-2005A
			Control-silicon	NC	CZ LM30-2010BT	CZ LMF31-2015B	CZ LMF32-2020B	CZ LMF33-2005B
Relay output								
Non-Flush	DC 10-30 VDC	NPN	NO	CZ LM30-3015NAT	CZ LMF31-3020NA		CZ LMF33-3008NA	
			NC	CZ LM30-3015NBT	CZ LMF31-3020NB		CZ LMF33-3008NB	
			NO+NC	CZ LM30-3015NCT	CZ LMF31-3020NC		CZ LMF33-3008NC	
		PNP	NO	CZ LM30-3015PAT	CZ LMF31-3020PA		CZ LMF33-3008PA	
			NC	CZ LM30-3015PBT	CZ LMF31-3020PB		CZ LMF33-3008PB	
	two wire system	NO+NC	CZ LM30-3015PCT	CZ LMF31-3020PC		CZ LMF33-3008PC		
		NO	CZ LM30-3015LAT	CZ LMF31-3020LA		CZ LMF33-3008LA		
		NC	CZ LM30-3015LBT	CZ LMF31-3020LB		CZ LMF33-3008LB		
		AC 90-250 VAC	SCR	NO	CZ LM30-2015AT	CZ LMF31-2020A		CZ LMF33-2008A
			Control-silicon	NC	CZ LM30-2015BT	CZ LMF31-2020B		CZ LMF33-2008B
Relay output								
Controloutput	DC	200mA	200mA					
	SCR/Relay	300mA	300mA					
Output voltage drop DC/AC		(NPN PNP) 3V :3.9V AC 10V DC<3V AC<10V						
Consumption current		(NPN PNP) DC 12V 8mA 24V 15mA AC 10mA DC<15mA AC<10mA						
Standard detected object								
Repeated precision		0.5	0.5					
DC/AC		200Hz/10Hz	200Hz/10Hz					
Working environment temperature		-25°C~+65°C	-25°C~+65°C					
Insulation resistance		50MΩ	50MΩ					
Shell material		Metal	Metal					
Protection grade		IP67	IP67					
Alyemative model at home and abroad		EZE-X18ME1-M1						