



FEATURES

- Universal 85 - 264VAC or 120 - 373VDC input voltage
- Accepts AC or DC input (dual-use of same terminal)
- Operating ambient temperature range: -30°C to +70°C
- Low standby power consumption, high efficiency
- High I/O isolation test voltage up to 4000VAC
- Low ripple & noise
- Output short circuit, over-current, over-voltage protection
- Safety according to IEC/EN/UL62368, EN60335, GB4943, EN61558
- Withstand 300VAC surge input for 5s
- Over-voltage class III (designed to meet EN61558)
- Operating up to 5000m altitude

LM100-20Bxx series is one of Mornsun's enclosed AC-DC switching power supply. It features universal AC input and at the same time accepts DC input voltage, cost-effective, low no load power consumption, high efficiency and high reliability. These converters offer excellent EMC performance and meet IEC/EN61000-4, CISPR32/EN55032, IEC/EN/UL62368, EN60335, GB4943, EN61558 standards and they are widely used in areas of industrial, LED, street light control, electricity, security, telecommunications, smart home etc.

Selection Guide

Certification	Part No.*	Output Power (W)	Nominal Output Voltage and Current (Vo/Io)	Output Voltage Adjustable Range (V)	Efficiency at 230VAC (%) Typ.	Max. Capacitive Load (μF)
UL/CE/CCC/CB	LM100-20B05	90	5V/18A	4.5-5.5	86	10000
	LM100-20B12	102	12V/8.5A	10.2-13.8	87.5	6800
	LM100-20B15	105	15V/7.0A	13.5-18	87.5	3300
	LM100-20B24	108	24V/4.5A	21.6-28.8	90	2200
	LM100-20B36	100.8	36V/2.8A	32.4-39.6	90	1000
	LM100-20B48	110.4	48V/2.3A	43.2-52.8	91	470

Note: *Use suffix "C" for terminal with protective cover and suffix "Q" for conformal coating.

Input Specifications

Item	Operating Conditions		Min.	Typ.	Max.	Unit
Input Voltage Range	AC input		85	--	264	VAC
	DC input		120	--	373	VDC
Input Voltage Frequency			47	--	63	Hz
Input Current	115VAC		--	--	3	A
	230VAC		--	--	1.5	
Inrush Current	115VAC		--	35	--	
	230VAC			65	--	
Leakage Current	240VAC		<0.75mA			
Hot Plug			Unavailable			

Output Specifications

Item	Operating Conditions		Min.	Typ.	Max.	Unit
Output Voltage Accuracy	Full load range	5V	--	±2	--	%
		12V/15V/24V/36V/48V	--	±1	--	
Line Regulation	Rated load		--	±0.5	--	

Load Regulation	0% - 100% load	5V	--	±1	--	
		12V/15V/24V/36V/48V	--	±0.5	--	
Output Ripple & Noise*	20MHz bandwidth (peak-to-peak value)	5V	--	100	--	mV
		12V/15V	--	120	--	
		24V	--	150	--	
		36V/48V	--	200	--	
Temperature Coefficient			--	±0.03	--	%/°C
Minimum Load			0	--	--	%
Stand-by Power Consumption	230VAC	5V/12V/15V/24V	--	--	0.3	W
		36V/48V	--	--	0.5	
Hold-up Time	115VAC		5	10	--	ms
	230VAC		45	55	--	
Short Circuit Protection	Recovery time <5s after the short circuit disappear.		Hiccup, continuous, self-recovery			
Over-current Protection			110% - 160% Io, self-recovery			
Over-voltage Protection	5V	≤7.5VDC (Output voltage turn off, hiccup or clamp)				
	12V	≤19.2VDC (Output voltage turn off, hiccup or clamp)				
	15V	≤24VDC (Output voltage turn off, hiccup or clamp)				
	24V	≤38.4VDC (Output voltage turn off, hiccup or clamp)				
	36V	≤57.6VDC (Output voltage turn off, hiccup or clamp)				
	48V	≤60VDC (Output voltage turn off, hiccup or clamp)				
Note: *The "Tip and barrel method" is used for ripple and noise test, output parallel 47uF electrolytic capacitor and 0.1uF ceramic capacitor, please refer to Enclosed Switching Power Supply Application Notes for specific information.						

General Specifications

Item	Operating Conditions		Min.	Typ.	Max.	Unit	
Isolation	Input - ⊕	Electric strength test for 1min., leakage current <10mA	2000	--	--	VAC	
	Input - output		4000	--	--		
	Output - ⊕		1250	--	--		
Insulation Resistance	Input - ⊕	At 500VDC	100	--	--	MΩ	
	Input - output		100	--	--		
	Output - ⊕		100	--	--		
Operating Temperature			-30	--	+70	°C	
Storage Temperature			-40	--	+85		
Storage Humidity	Non-condensing		10	--	95	%RH	
Operating Humidity			20	--	90		
Switching Frequency			--	65	--	kHz	
Power Derating	Operating temperature derating	5V output	+45°C to +70°C	1.6	--	--	% / °C
		Other output	+50°C to +70°C	2.0	--	--	
	Input voltage derating	85VAC-115VAC	0.67	--	--	%/VAC	
Safety Standard			Meet IEC/EN/UL62368/EN60335/GB4943/EN61558				
Safety Certification			IEC/EN/UL62368/EN60335/GB4943/EN61558				
Safety Class			CLASS I				
MTBF	MIL-HDBK-217F@25°C		>30,000 h				

Mechanical Specifications

Case Material	Metal (AL1100, SGCC)	
Dimension	129.00 x 97.00 x 30.00mm	
Weight	350g (Typ.)	5V
	305g (Typ.)	12V/15V/24V/36V/48V
Cooling Method	Free air convection	

Electromagnetic Compatibility (EMC)

Emissions	CE	CISPR32/EN55032	CLASS B	
	RE	CISPR32/EN55032	CLASS B	
	Harmonic current	IEC/EN61000-3-2	CLASS A	
Immunity	ESD	IEC/EN 61000-4-2	Contact ±6KV/Air ±8KV	Perf. Criteria A
	RS	IEC/EN 61000-4-3	10V/m	perf. Criteria A
	EFT	IEC/EN 61000-4-4	±2KV	perf. Criteria A
	Surge	IEC/EN 61000-4-5	line to line ±2KV/line to ground ±4KV	perf. Criteria A
	CS	IEC/EN61000-4-6	10 Vr.m.s	perf. Criteria A
	Voltage dip, short interruption and voltage variation	IEC/EN61000-4-11	0%, 70%	perf. Criteria B

Product Characteristic Curve

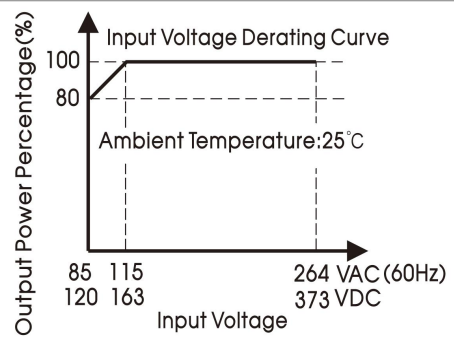
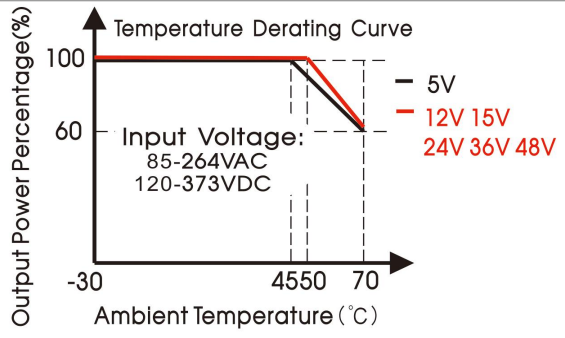

Note: 1. With an AC input voltage between 85-115VAC and a DC input between 120-163VDC the output power must be derated as per the temperature derating curves;
 2. This product is suitable for applications using natural air cooling; for applications in closed environment please consult factory or one of our FAE.

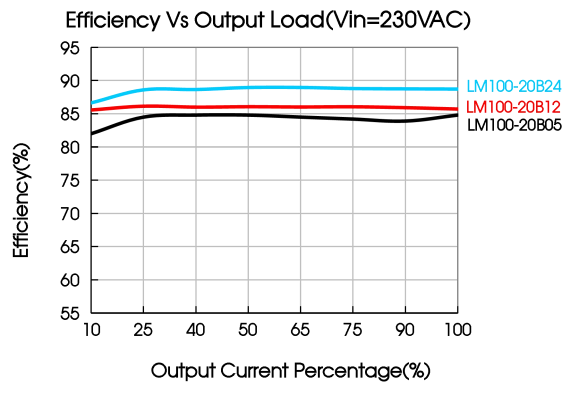
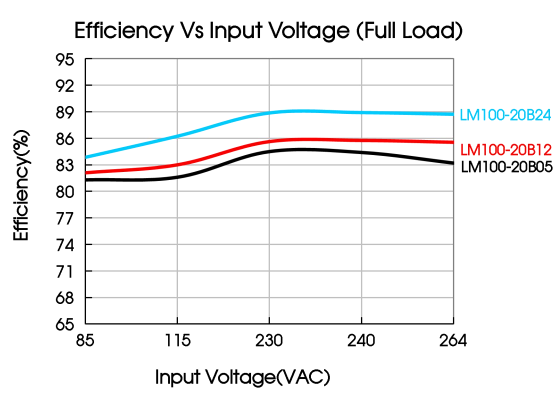

Dimensions and Recommended Layout

LM100-20Bxx、LM100-20Bxx-Q Series

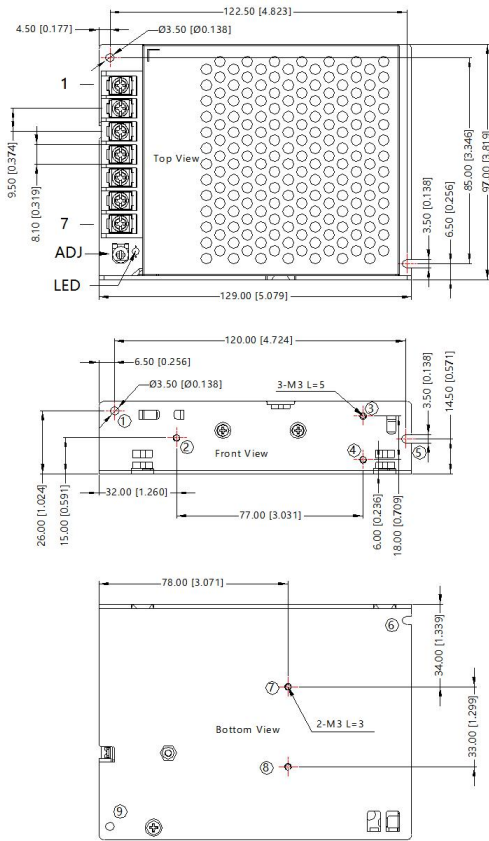

THIRD ANGLE PROJECTION

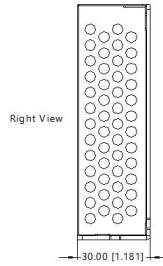

Pin-Out	
Pin	Function
1	AC(L)
2	AC(N)
3	⊥
4	-Vo
5	-Vo
6	+Vo
7	+Vo

①-⑨ any position must be connected to the earth (⊥)

Position	Screw Spec.	L(max)	Torque(max)
② - ④	M3	5mm	0.4N·m
⑦ - ⑧	M3	3mm	0.4N·m

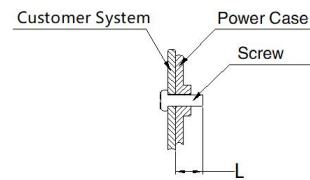

Note:
Unit: mm[inch]
Wire range: 22-12AWG
Connector tightening torque: M3.5, 0.8N·m
General tolerances: ± 1.00[± 0.039]

LM100-20Bxx-C Series

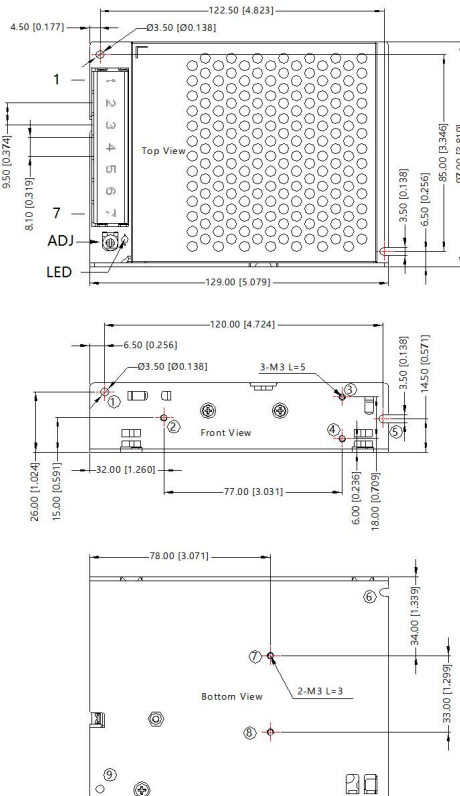

THIRD ANGLE PROJECTION

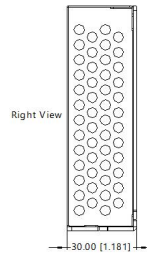

Pin-Out	
Pin	Function
1	AC(L)
2	AC(N)
3	⊥
4	-Vo
5	-Vo
6	+Vo
7	+Vo

①-⑨ any position must be connected to the earth (⊥)

Position	Screw Spec.	L(max)	Torque(max)
② - ④	M3	5mm	0.4N·m
⑦ - ⑧	M3	3mm	0.4N·m

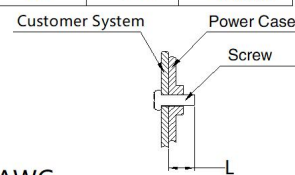

Note:
Unit: mm[inch]
Wire range: 22-12AWG
Connector tightening torque: M3.5, 0.8N·m
General tolerances: ± 1.00[± 0.039]

Note:

1. For additional information on Product Packaging please refer to www.mornsun-power.com. Packaging bag number: 58220120;
2. Unless otherwise specified, parameters in this datasheet were measured under the conditions of $T_a=25^{\circ}\text{C}$, humidity<75%RH with nominal input voltage and rated output load;
3. The ambient temperature derating of $5^{\circ}\text{C}/1000\text{m}$ is needed for operating altitude greater than 2000m;
4. All index testing methods in this datasheet are based on our company corporate standards;
5. In order to improve the efficiency at high input voltage, there will be audible noise generated, but it does not affect product performance and reliability;
6. We can provide product customization service, please contact our technicians directly for specific information;
7. Products are related to laws and regulations: see "Features" and "EMC";
8. The out case needs to be connected to the earth of system when the terminal equipment in operating;
9. Our products shall be classified according to ISO14001 and related environmental laws and regulations, and shall be handled by qualified units.
10. The power supply is considered a component which will be installed into a final equipment. All EMC tests should be confirmed with the final equipment. Please consult our FAE for EMC test operation instructions.

Mornsun Guangzhou Science & Technology Co., Ltd.

Address: No. 5, Kehui St. 1, Kehui Development Center, Science Ave., Guangzhou Science City, Huangpu District, Guangzhou, P. R. China

Tel: 86-20-38601850

Fax: 86-20-38601272

E-mail: info@mornsun.cn

www.mornsun-power.com

MORNSUN®

MORNSUN Guangzhou Science & Technology Co., Ltd.

2020.06.23-A/6

Page 5 of 5

MORNSUN Guangzhou Science & Technology Co., Ltd. reserves the copyright and right of final interpretation