

1A Bipolar Linear Regulator

DESCRIPTION

BL1117 is a series of low dropout three-terminal regulators with a dropout of 1.3V at 1A load current. BL1117 features a very low standby current 2mA compared to 5mA of competitor.

Other than a fixed version, $V_{out} = 1.2V, 1.5V, 1.8V, 2.5V, 3.3V, 5V,$ and $12V$, BL1117 has an adjustable version, which can provide an output voltage from 1.25 to 12V with only two external resistors.

BL1117 offers thermal shut down and current limit functions, to assure the stability of chip and power system. And it uses trimming technique to guarantee output voltage accuracy within $\pm 2\%$. Other output voltage accuracy can be customized on demand, such as $\pm 1\%$

BL1117 is available in SOT-223, TO-252 power package.

FEATURES

- Other than a fixed version and an adjustable version, output value can be customized on demand.
- Maximum output current is 1A
- Range of operation input voltage: Max 12V
- Standby current: 2mA (typ.)
- Line regulation: 0.1%/V (typ.)
- Load regulation: 10mV (typ.)
- Environment Temperature: $-40^{\circ}C \sim 85^{\circ}C$

APPLICATIONS

- Power Management for Computer Mother Board, Graphic Card
- BLD Monitor and BLD TV
- DVD Decode Board
- ADSL Modem
- Post Regulators for Switching Supplies

TYPICAL APPLICATION

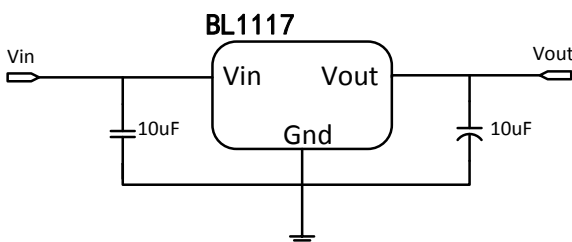

Application circuit of BL1117 fixed version

NOTE: Input capacitor ($C_{in}=10\mu F$) and Output capacitor ($C_{out}=10\mu F$) are recommended in all application circuit. Tantalum or MLCC capacitor is recommended.

TYPICAL ELECTRICAL CHARACTERISTIC

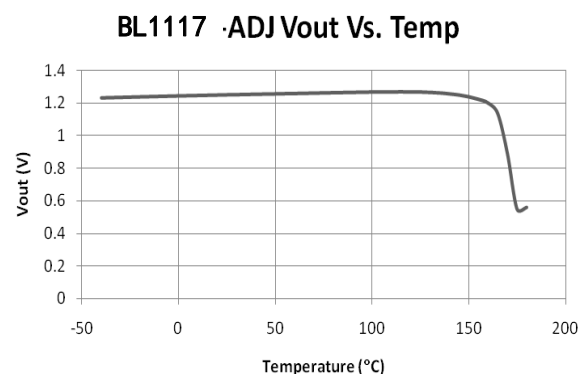

ORDERING INFORMATION

BL1117-XX X X

Package Type:

X: SOT-223

Y: TO-252

Temp. Range & Rohs Std.:

A: 85C & Pb-free Rohs Std, Output voltage accuracy within $\pm 1\%$

C: 85C & Pb-free Rohs Std, Output voltage accuracy within $\pm 2\%$

Output Voltage:

12.....1.2V

15.....1.5V

18.....1.8V

25.....2.5V

33.....3.3V

50.....5.0V

Default: Adjustable Version

PIN CONFIGURATION

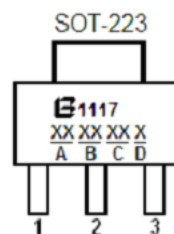

Pin Description:

Fixed Version

Pin No.	Symbol	Definition
1	GND	Ground
2	Vout	Output
3	Vin	Input

Adjustable Version

Pin No.	Symbol	Definition
1	Adj.	Adjustable
2	Vout	Output
3	Vin	Input

A: Means assembly year and weeks

Year	2010	2011	2012	2013	...
Y	0	1	2	3	...

Week	1	2	...	26	27	...	52	53
W	A	B	...	Z	\bar{A}	...	\bar{Z}	A

B: Means Manufacture LOT No.

C: Means Output Voltage Value

D: Means Temp. Range&Rohs Std

ABSOLUTE MAXIMUM RATING

Parameter		Value
Max Input Voltage		15V ^①
Max Operating Junction Temperature(Tj)+ Ambient Temperature(Ta)		150°C
Ambient Temperature(Ta)		-40°C – 85°C
Package Thermal Resistance	SOT-223	20°C / W
	TO-252	10°C / W
Storage Temperature(Ts)		-40°C - 150°C
Lead Temperature & Time		260°C, 10S

Note: Exceed these limits to damage to the device. Exposure to absolute maximum rating conditions may affect device reliability.

RECOMMENDED WORK CONDITIONS

Parameter	Value
Input Voltage Range	Max. 12V ^①
Operating Junction Temperature(Tj)	-20°C –125°C

^①Exceptional for BL1117-12V, the maximum input voltage for BL1117-12V is 20V.

ELECTRICAL CHARACTERISTICS+

T_j=25°C

Symbol	Parameter	Conditions	Min	Typ	Max	Unit
V _{ref}	Reference Voltage	BL1117-ADJ 10mA ≤ I _{out} ≤ 1A, V _{in} = 3.25V	1.225	1.25	1.275	V
V _{out}	Output Voltage	BL1117-1.2V 0 ≤ I _{out} ≤ 1A, V _{in} = 3.2V	1.176	1.2	1.224	V
		BL1117-1.5V 0 ≤ I _{out} ≤ 1A, V _{in} = 3.5V	1.47	1.5	1.53	V
		BL1117-1.8V 0 ≤ I _{out} ≤ 1A, V _{in} = 3.8V	1.764	1.8	1.836	V
		BL1117-2.5V 0 ≤ I _{out} ≤ 1A, V _{in} = 4.5V	2.45	2.5	2.55	V
		BL1117-3.3V 0 ≤ I _{out} ≤ 1A, V _{in} = 5.3V	3.234	3.3	3.366	V
		BL1117-5.0V 0 ≤ I _{out} ≤ 1A, V _{in} = 7.0V	4.9	5	5.1	V
		BL1117-12.0V 0 ≤ I _{out} ≤ 1A, V _{in} = 14V	11.76	12	12.24	V
		ΔV _{out}	Line Regulation	BL1117-1.2V I _{out} = 10mA, 2.7V ≤ V _{in} ≤ 10V		0.1
BL1117-ADJ I _{out} = 10mA, 2.75V ≤ V _{in} ≤ 12V				0.1	0.2	%/V
BL1117-1.5V I _{out} = 10mA, 3.0V ≤ V _{in} ≤ 12V				0.1	0.2	%/V
BL1117-1.8V I _{out} = 10mA, 3.3V ≤ V _{in} ≤ 12V				0.1	0.2	%/V
BL1117-2.5V I _{out} = 10mA, 4.0V ≤ V _{in} ≤ 12V				0.1	0.2	%/V
BL1117-3.3V I _{out} = 10mA, 4.8V ≤ V _{in} ≤ 12V				0.1	0.2	%/V
BL1117-5.0V I _{out} = 10mA, 6.5V ≤ V _{in} ≤ 12V				0.1	0.2	%/V
BL1117-12.0V I _{out} = 10mA, 13.5V ≤ V _{in} ≤ 20V				0.1	0.2	+%/V
ΔV _{out}	Load Regulation	BL1117-1.2V V _{in} = 2.7V, 10mA ≤ I _{out} ≤ 1A		10	30	mV
		BL1117-ADJ V _{in} = 2.75V, 10mA ≤ I _{out} ≤ 1A		10	30	mV
		BL1117-1.5V V _{in} = 3.0V, 10mA ≤ I _{out} ≤ 1A		10	30	mV
		BL1117-1.8V V _{in} = 3.3V, 10mA ≤ I _{out} ≤ 1A		10	30	mV
		BL1117-2.5V V _{in} = 4.0V, 10mA ≤ I _{out} ≤ 1A		10	30	mV
		BL1117-3.3V V _{in} = 4.8V, 10mA ≤ I _{out} ≤ 1A		10	30	mV
		BL1117-5.0V V _{in} = 6.5V, 10mA ≤ I _{out} ≤ 1A		10	30	mV
		BL1117-12.0V V _{in} = 13.5V, 10mA ≤ I _{out} ≤ 1A		10	30	mV

ELECTRICAL CHARACTERISTICS continued

+ T_j=25°C

Symbol	Parameter	Conditions	Min	Typ	Max	Unit
Vdrop	Dropout Voltage	I _{out} =100mA		1.23	1.3	V
		I _{out} =1A		1.3	1.5	V
I _{limit}	Current Limit	V _{in} -V _{out} =2V, T _j =25°C	1			A
SVR	Supply Voltage Rejection	f = 120Hz, V _{IN} - V _{OUT} = 3V + 1VPP Ripple		60		dB
I _{min}	Minimum Load Current	BL1117-ADJ	4	6	10	mA
I _q	Quiescent Current	BL1117-1.2V, V _{in} =10V	1	2	5	mA
		BL1117-1.5V, V _{in} =11V	1	2	5	mA
		BL1117-1.8V, V _{in} =12V	1	2	5	mA
		BL1117-2.5V, V _{in} =12V	1	2	5	mA
		BL1117-3.3V, V _{in} =12V	1	2	5	mA
		BL1117-5.0V, V _{in} =12V	1	2	5	mA
		BL1117-12.0V, V _{in} =20V	1	2	5	mA
I _{Adj}	Adjust Pin Current	BL1117-ADJ V _{in} =5V, 10mA ≤ I _{out} ≤ 1A	35	55	120	uA
I _{change}	I _{adj} change	BL1117-ADJ V _{in} =5V, 10mA ≤ I _{out} ≤ 1A		0.2	10	uA
ΔV/ΔT	Temperature coefficient			±100		ppm
θ _{JC}	Thermal Resistance	SOT-223		20		°C/W
		TO-252		10		
		TO-220		4.5		
θ _{JA}	Thermal Resistance Junction-to-Ambient (No air flow)	SOT-223 (No heat sink)		136		°C/W
		TO-252 (No heat sink)		92		

Note1: All test are conducted under ambient temperature 25°C and within a short period of time 20ms

Note2: Load current smaller than minimum load current of BL1117-ADJ will lead to unstable or oscillation output.

BLOCK DIAGRAM

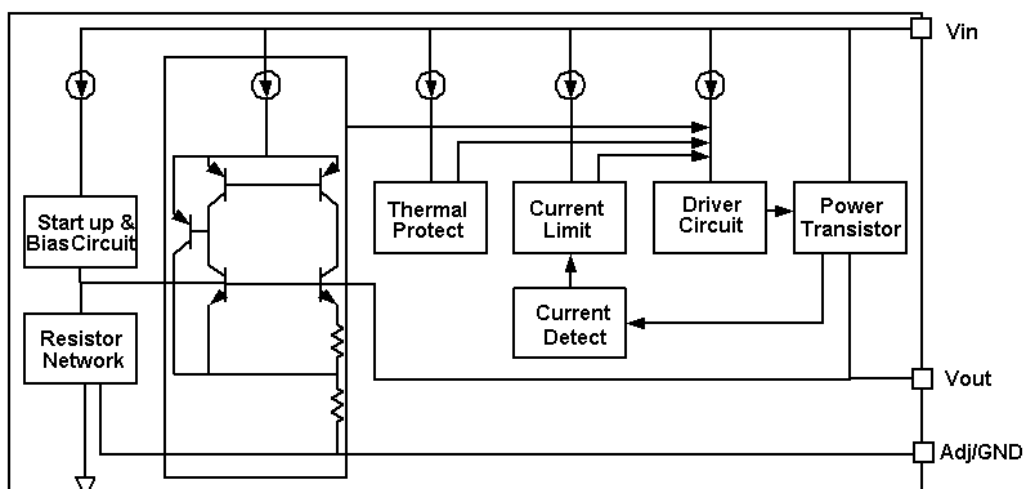

DETAILED DESCRIPTION

BL1117 is a series of low dropout voltage, three terminal regulators. Its application circuit is very simple: the fixed version only needs two capacitors and the adjustable version only needs two resistors and two capacitors to work. It is composed of some modules including start-up circuit, bias circuit, bandgap, thermal shutdown, current limit, power transistors and its driver circuit and so on.

The thermal shut down modules can assure chip and its application system working safety when the junction temperature is larger than 140°C.

The bandgap module provides stable reference voltage, whose temperature coefficient is compensated by careful design considerations. The temperature coefficient is under 100 ppm/°C. And the accuracy of output voltage is guaranteed by trimming technique.

TYPICAL APPLICATION

BL1117 has an adjustable version and six fixed versions (1.2V, 1.5V, 1.8V, 2.5V, 3.3V, 5V and 12V)

Fixed Output Voltage Version

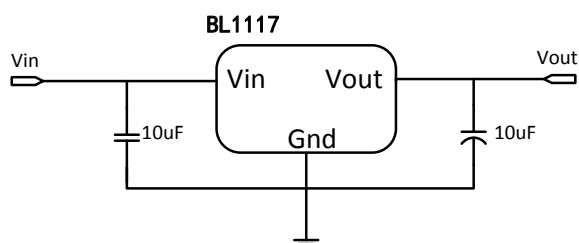

Application circuit of BL1117 fixed version

- 1) Recommend using 10µF tan capacitor or MLCC capacitor as bypass capacitor (C1) for all application circuit.
- 2) Recommend using 10µF tan capacitor MLCC capacitor to assure circuit stability.
- 3) Capacitor ESR range: 3mΩ ~ 22Ω

Adjustable Output Voltage Version

BL1117-ADJ provides a 1.25V reference voltage. Any output voltage between 1.25V~12V can be achievable by choosing two external resistors (schematic is shown below), R1 and R2

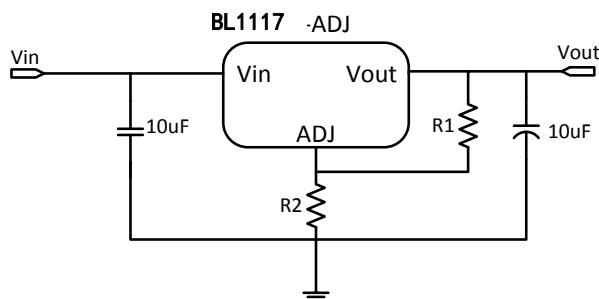

Application Circuit of BL1117-ADJ

The output voltage of adjustable version follows the equation: $V_{out}=1.25\times(1+R2/R1)+I_{Adj}\times R2$. We can ignore $+I_{Adj}$ because I_{Adj} (about 50uA) is much less than the current of R1 (about 2~10mA).

- 1) To meet the minimum load current (>10mA) requirement, R1 is recommended to be 125ohm or lower. As BL1117-ADJ can keep itself stable at load current about 2mA, R1 is not allowed to be higher than 625ohm.
- 2) Using a bypass capacitor (C_{ADJ}) between the ADJ pin and ground can improve ripple rejection. This bypass capacitor prevents ripple from being amplified as the output voltage is increased. The impedance of C_{ADJ} should be less than R1 to prevent ripple from being amplified. As R1 is normally in the range of 100Ω~500Ω, the value of C_{ADJ} should satisfy this equation: $1/(2\pi\times f_{ripple}\times C_{ADJ})<R1$.

THERMAL CONSIDERATIONS

We have to take heat dissipation into great consideration when output current or differential voltage of input and output voltage is large. Because in such cases, the power dissipation consumed by BL1117 is very large. BL1117 series uses SOT-223 package type and its thermal resistance is about 20°C/W. And the copper area of application board can affect the total thermal resistance. If copper area is 5cm*5cm (two sides), the resistance is about 30°C/W. So the total thermal resistance is about 20°C/W + 30°C/W. We can decrease total thermal resistance by increasing copper area in application board. When there is no good heat dissipation copper are in PCB, the total thermal resistance will be as high as 120°C/W, then the power dissipation of BL1117 could allow on itself is less than 1W. And furthermore, BL1117 will work at junction temperature higher than 125°C under such condition and no lifetime is guaranteed.

TYPICAL PERFORMANCE CHARACTERISTICS

$T=25^{\circ}\text{C}$ unless specified.

Line Regulation

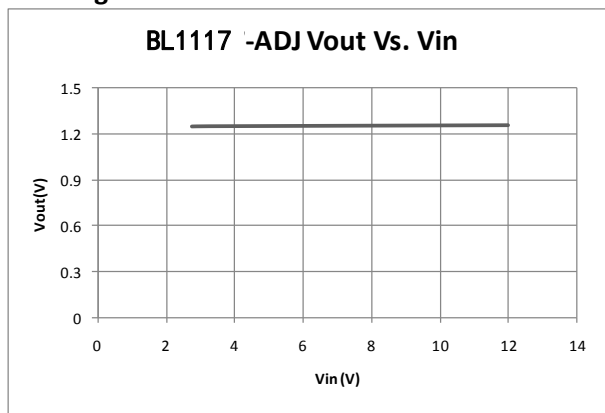

Load Regulation

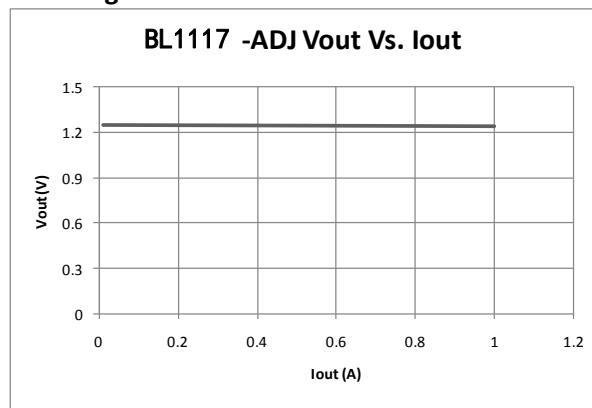

Dropout Voltage

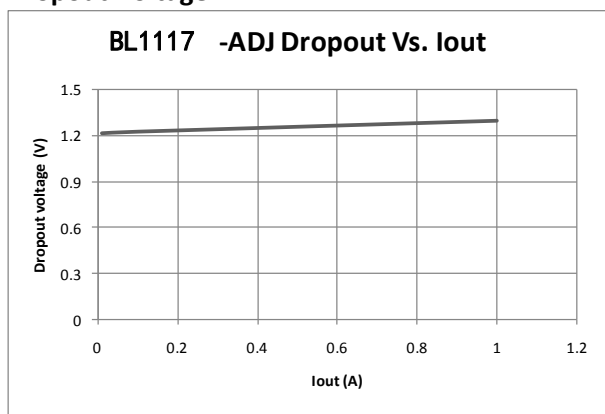

Thermal performance with OTP

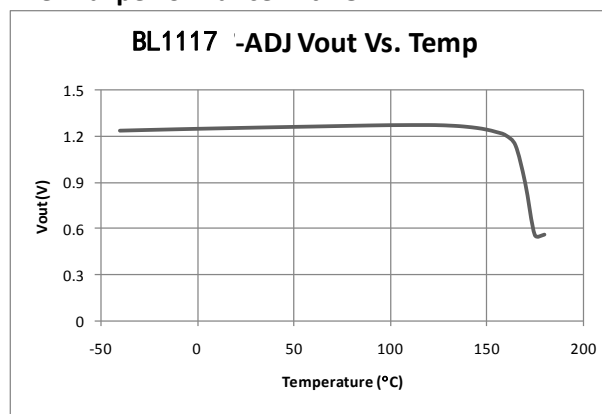

APPLICATION NOTE:

Load Transient Response

Test Condition:

$V_{IN}=5V$, $V_{OUT}=3.3V$, $C_{IN}=1\mu F$ (Ceramic), $C_{OUT}=10\mu F$ (Ceramic).

I : $I_{out}=10mA\sim 100mA$

CH2: Output Voltage (500mV/div, DC), CH4: Output Current(50mA/div)

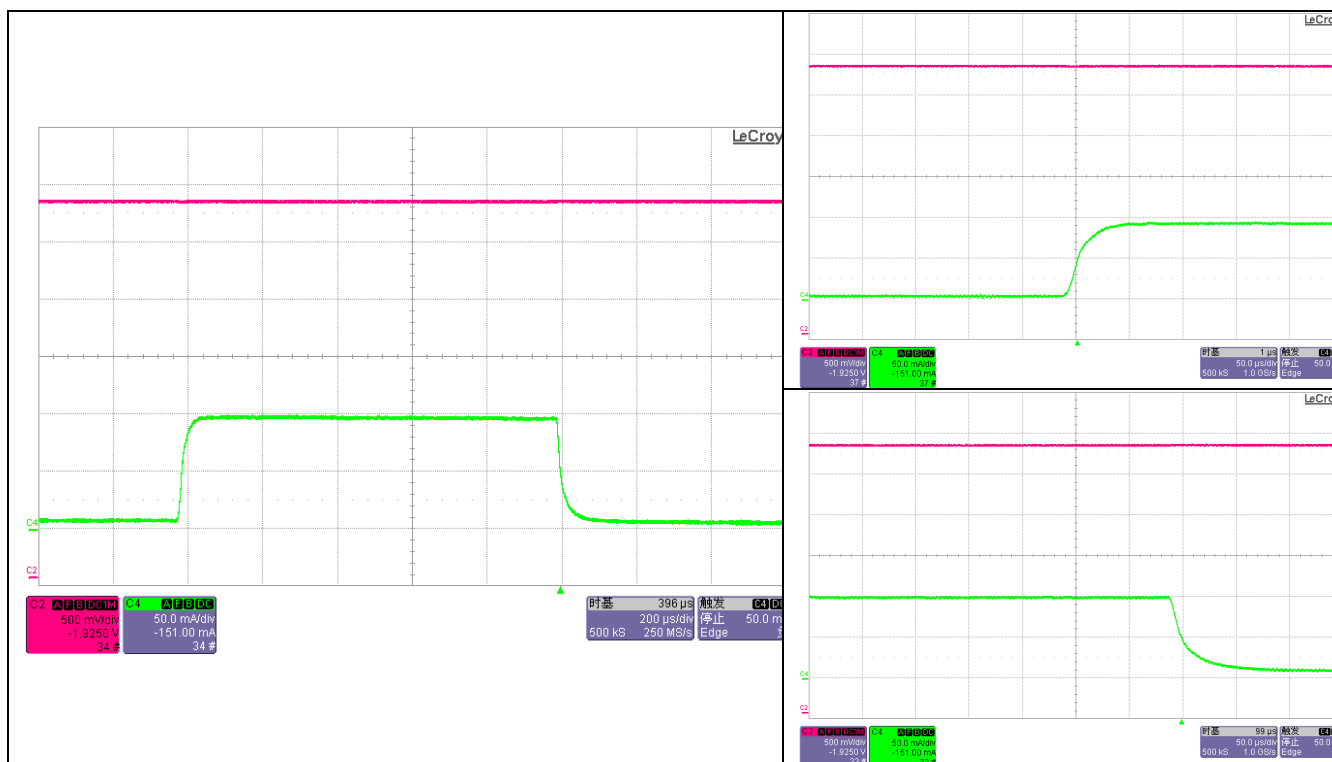

I : Iout=10mA~200mA

CH2: Output Voltage (500mV/div, DC), CH4: Output Current(50mA/div)

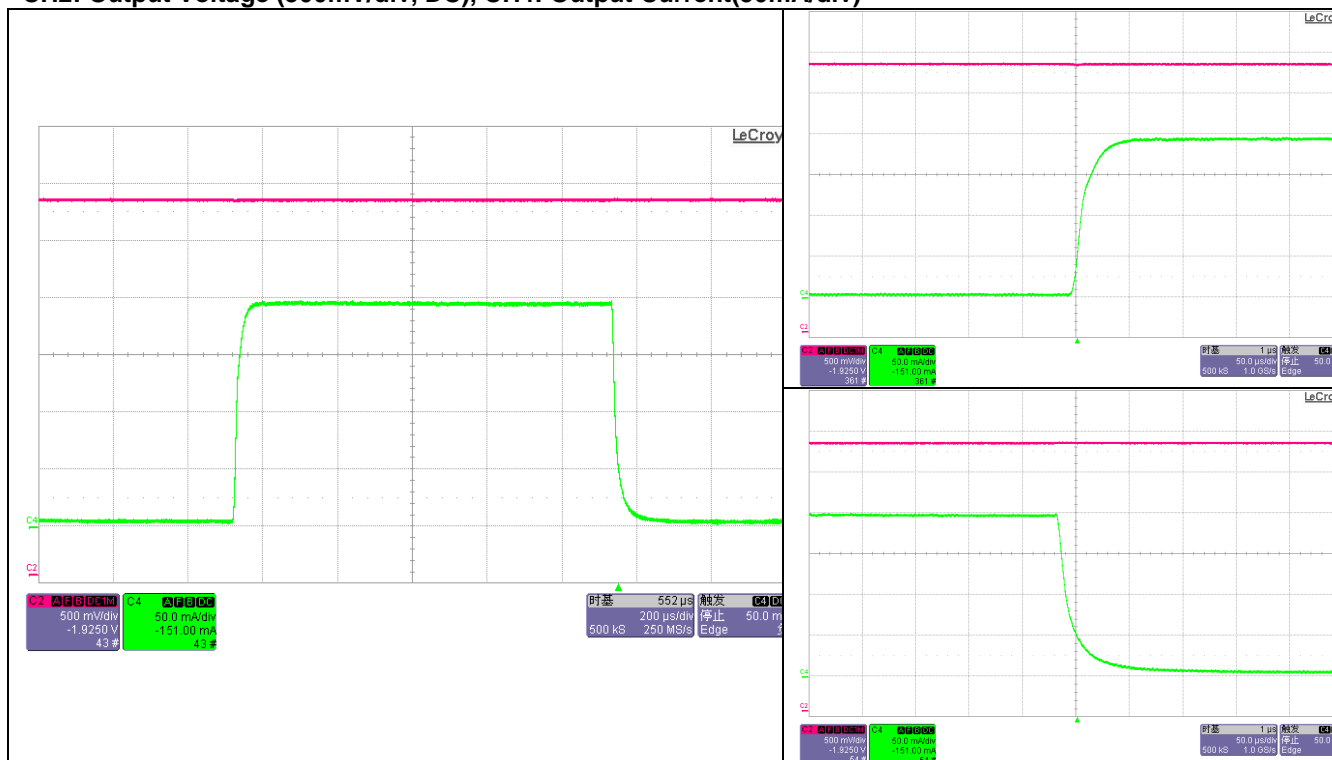

I : Iout=10mA~500mA

CH2: Output Voltage (500mV/div, DC), CH4: Output Current(200mA/div)

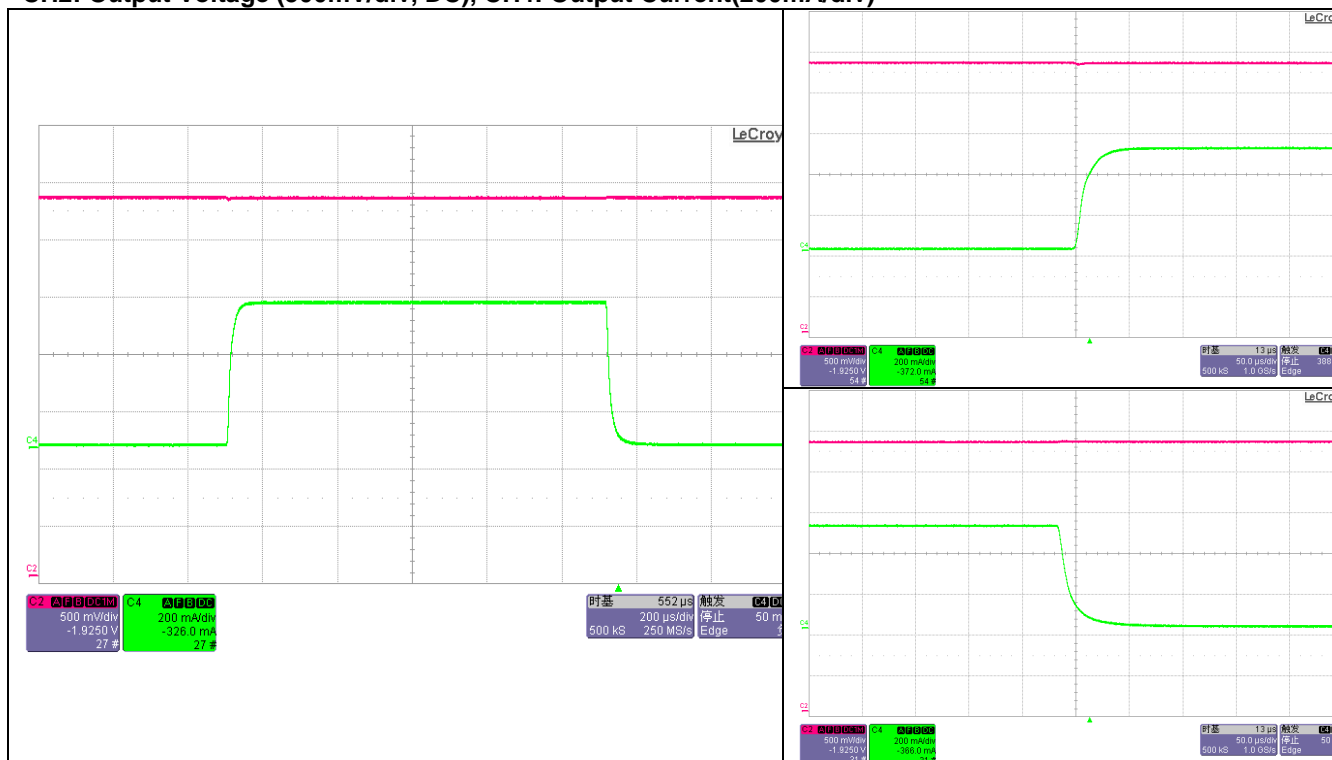

I : Iout=10mA~800mA

CH2: Output Voltage (500mV/div, DC), CH4: Output Current(200mA/div)

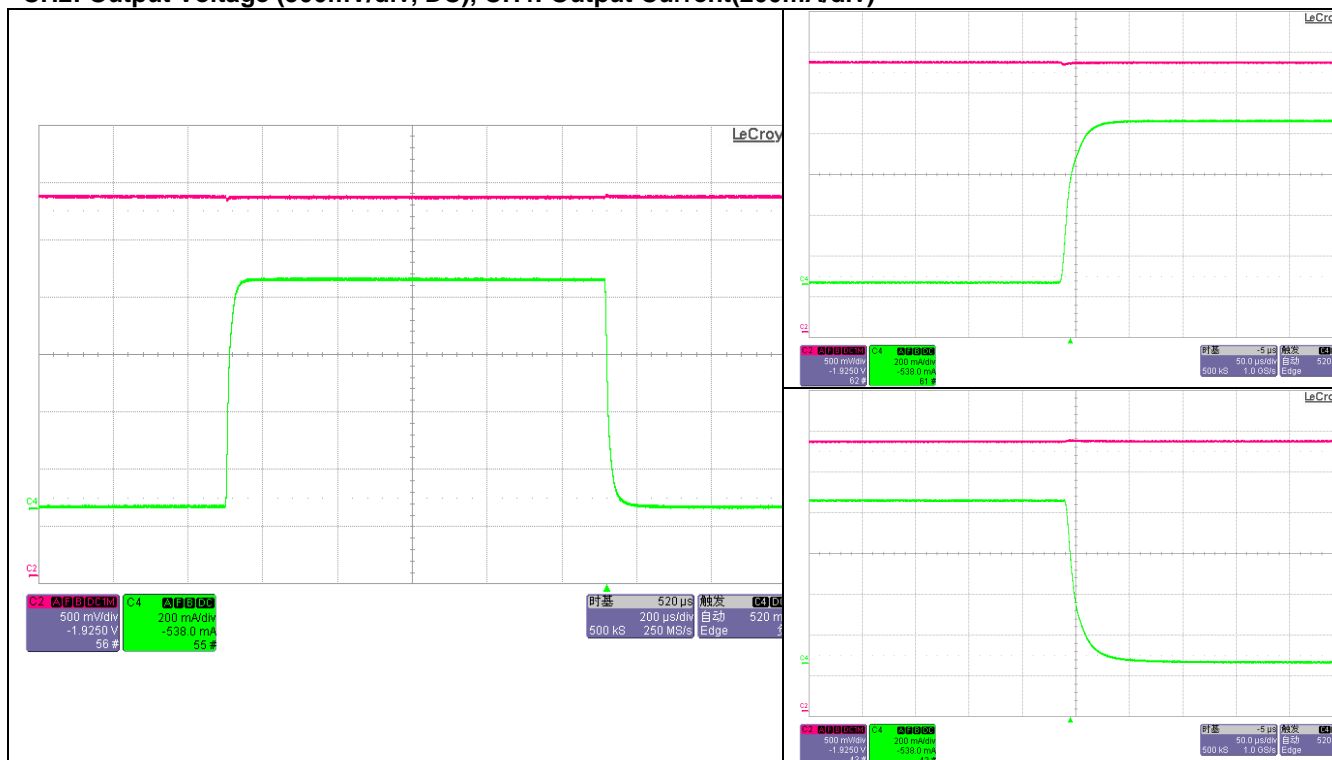

Load Transient Response

Test Condition:

V_{IN}=3.3V, V_{OUT}=ADJ, C_{IN}=1uF (Ceramic), C_{OUT}=10uF (Ceramic).

I : Iout=10mA~100mA

CH2: Output Voltage (200mV/div, DC), CH4: Output Current (50mA/div)

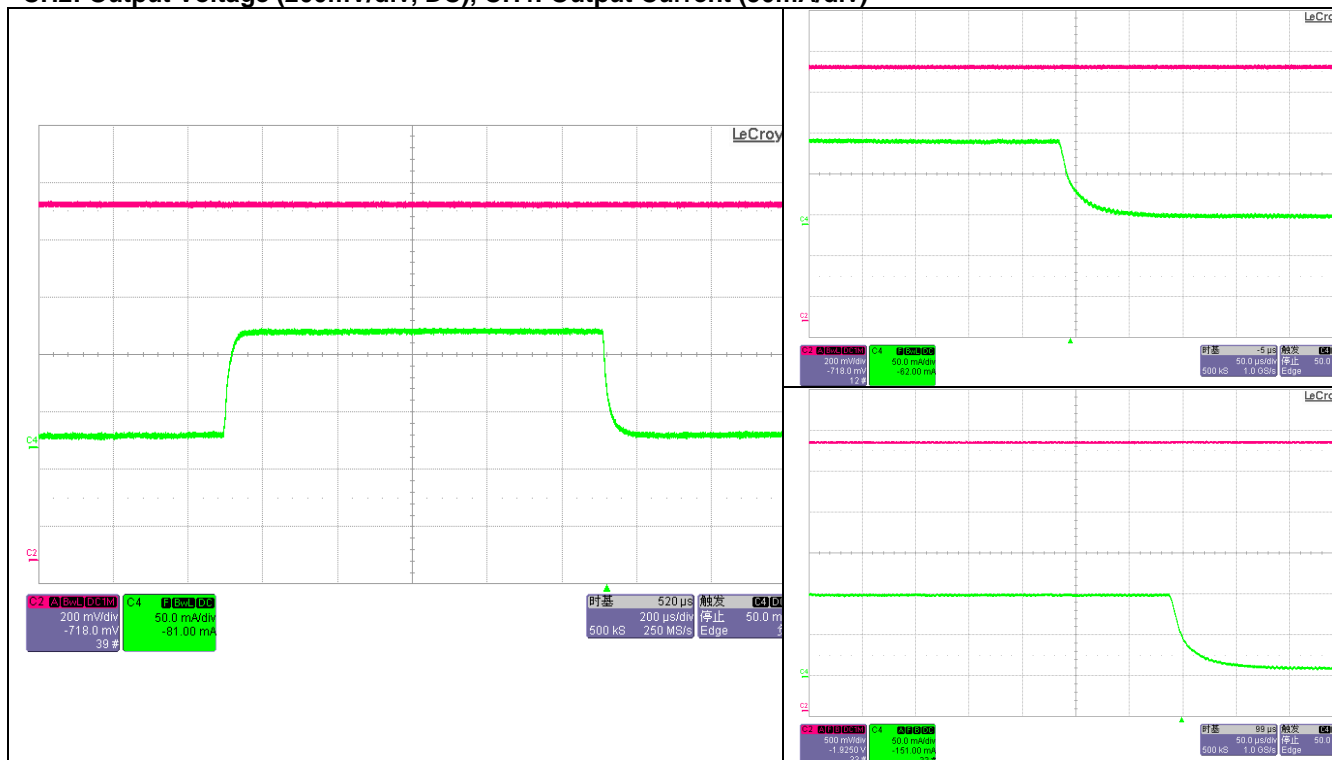

I : Iout=10mA~200mA

CH2: Output Voltage (200mV/div, DC), CH4: Output Current(50mA/div)

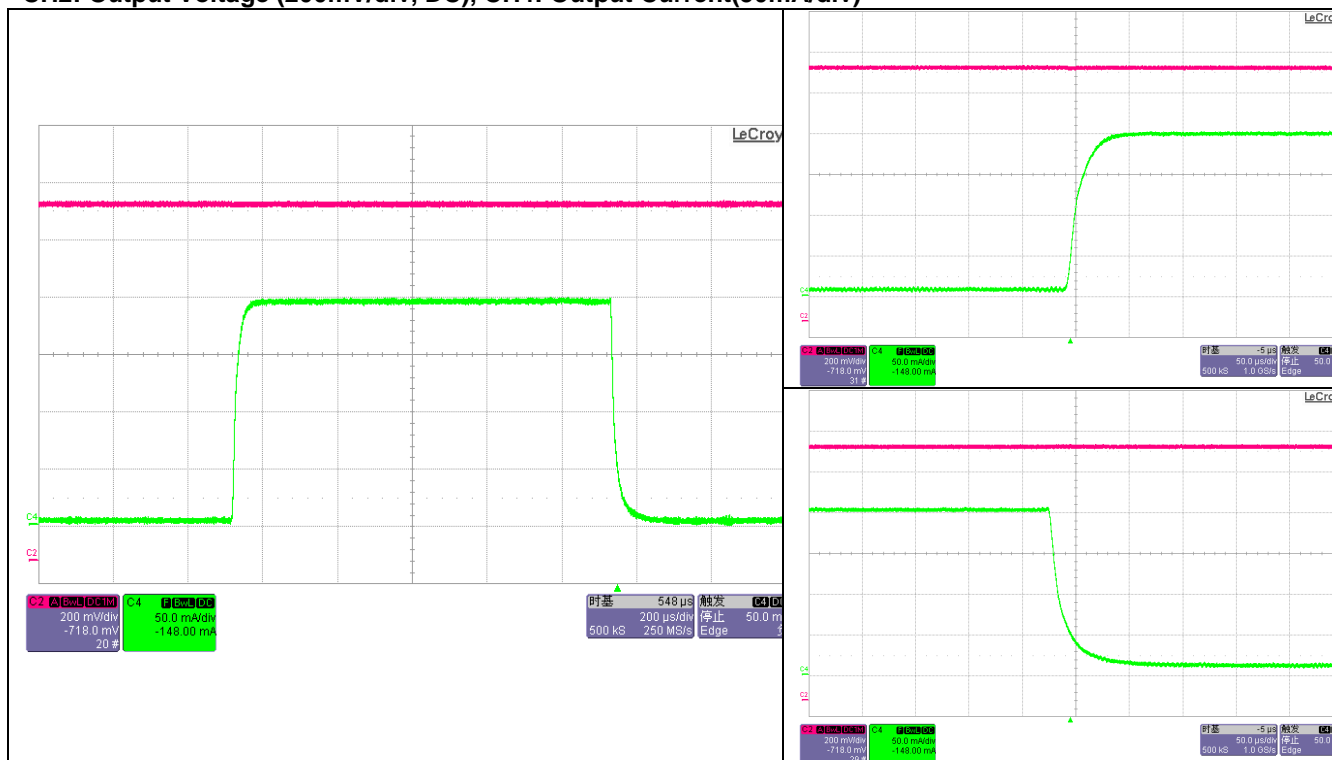

I : Iout=10mA~500mA

CH2: Output Voltage (200mV/div, DC), CH4: Output Current(200mA/div)

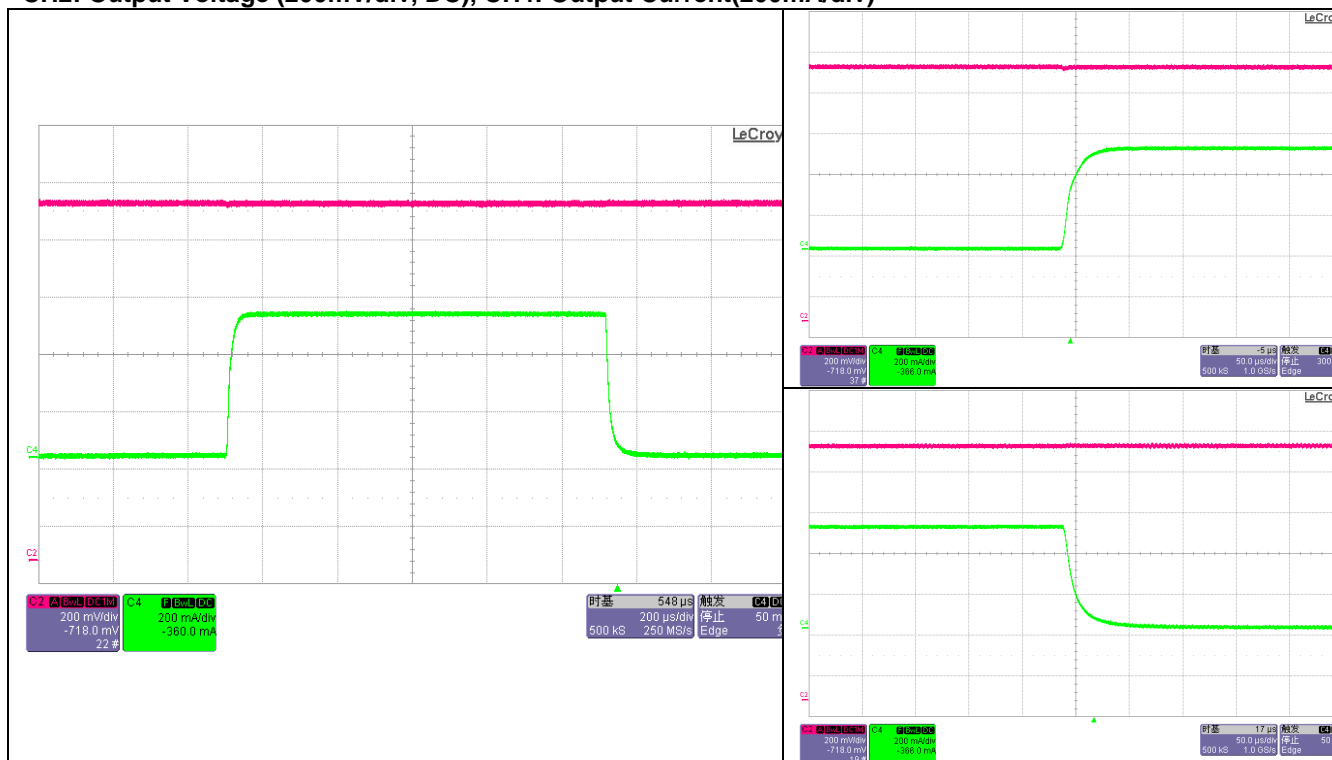

I : Iout=10mA~800mA

CH2: Output Voltage (200mV/div, DC), CH4: Output Current(200mA/div)

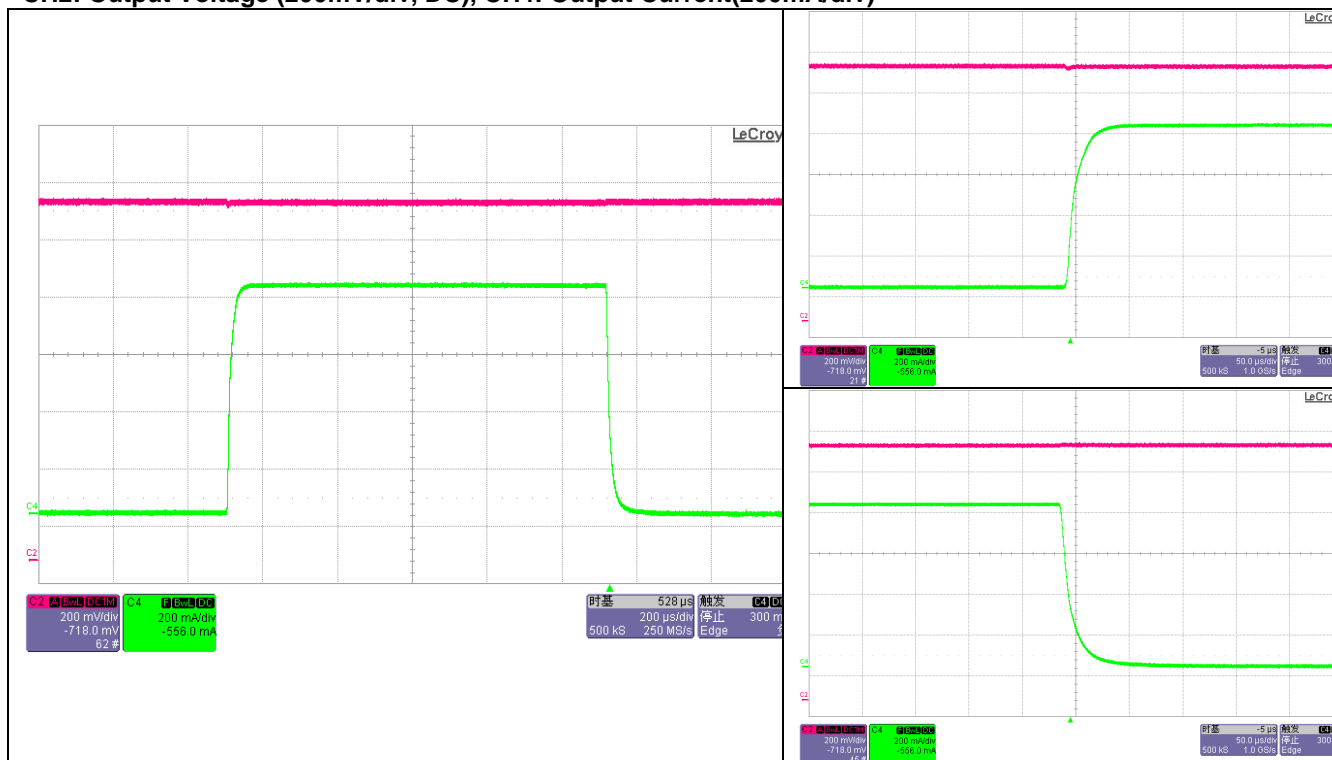

PACKAGE OUTLINE

Package	SOT-223	Devices per reel	2500	Unit	mm																																																																																								
Package specification:																																																																																													
				<table border="1"> <thead> <tr> <th></th> <th>MIN</th> <th>NOM</th> <th>MAX.</th> </tr> </thead> <tbody> <tr><td>A</td><td>1.50</td><td>1.65</td><td>1.80</td></tr> <tr><td>A1</td><td>0.02</td><td>0.06</td><td>0.10</td></tr> <tr><td>A2</td><td>1.45</td><td>1.60</td><td>1.75</td></tr> <tr><td>A3</td><td>0.80</td><td>0.90</td><td>1.00</td></tr> <tr><td>b</td><td>0.67</td><td>-</td><td>0.80</td></tr> <tr><td>b1</td><td>0.66</td><td>0.71</td><td>0.75</td></tr> <tr><td>b2</td><td>2.96</td><td>-</td><td>3.09</td></tr> <tr><td>b3</td><td>2.95</td><td>3.00</td><td>3.05</td></tr> <tr><td>c</td><td>0.30</td><td>-</td><td>0.35</td></tr> <tr><td>c1</td><td>0.29</td><td>0.30</td><td>0.31</td></tr> <tr><td>D</td><td>6.35</td><td>-</td><td>7.05</td></tr> <tr><td>D1</td><td>6.30</td><td>6.50</td><td>6.70</td></tr> <tr><td>E</td><td>6.80</td><td>7.00</td><td>7.20</td></tr> <tr><td>E1</td><td>3.40</td><td>3.50</td><td>3.60</td></tr> <tr><td>e</td><td colspan="3">2.30BSC</td></tr> <tr><td>e1</td><td colspan="3">4.60BSC</td></tr> <tr><td>L</td><td>0.80</td><td>1.00</td><td>1.20</td></tr> <tr><td>L1</td><td colspan="3">1.75REF</td></tr> <tr><td>L2</td><td colspan="3">0.25BSC</td></tr> <tr><td>θ</td><td>0°</td><td>-</td><td>8°</td></tr> <tr><td>θ 1</td><td>10°</td><td>12°</td><td>14°</td></tr> </tbody> </table>			MIN	NOM	MAX.	A	1.50	1.65	1.80	A1	0.02	0.06	0.10	A2	1.45	1.60	1.75	A3	0.80	0.90	1.00	b	0.67	-	0.80	b1	0.66	0.71	0.75	b2	2.96	-	3.09	b3	2.95	3.00	3.05	c	0.30	-	0.35	c1	0.29	0.30	0.31	D	6.35	-	7.05	D1	6.30	6.50	6.70	E	6.80	7.00	7.20	E1	3.40	3.50	3.60	e	2.30BSC			e1	4.60BSC			L	0.80	1.00	1.20	L1	1.75REF			L2	0.25BSC			θ	0°	-	8°	θ 1	10°	12°	14°
	MIN	NOM	MAX.																																																																																										
A	1.50	1.65	1.80																																																																																										
A1	0.02	0.06	0.10																																																																																										
A2	1.45	1.60	1.75																																																																																										
A3	0.80	0.90	1.00																																																																																										
b	0.67	-	0.80																																																																																										
b1	0.66	0.71	0.75																																																																																										
b2	2.96	-	3.09																																																																																										
b3	2.95	3.00	3.05																																																																																										
c	0.30	-	0.35																																																																																										
c1	0.29	0.30	0.31																																																																																										
D	6.35	-	7.05																																																																																										
D1	6.30	6.50	6.70																																																																																										
E	6.80	7.00	7.20																																																																																										
E1	3.40	3.50	3.60																																																																																										
e	2.30BSC																																																																																												
e1	4.60BSC																																																																																												
L	0.80	1.00	1.20																																																																																										
L1	1.75REF																																																																																												
L2	0.25BSC																																																																																												
θ	0°	-	8°																																																																																										
θ 1	10°	12°	14°																																																																																										

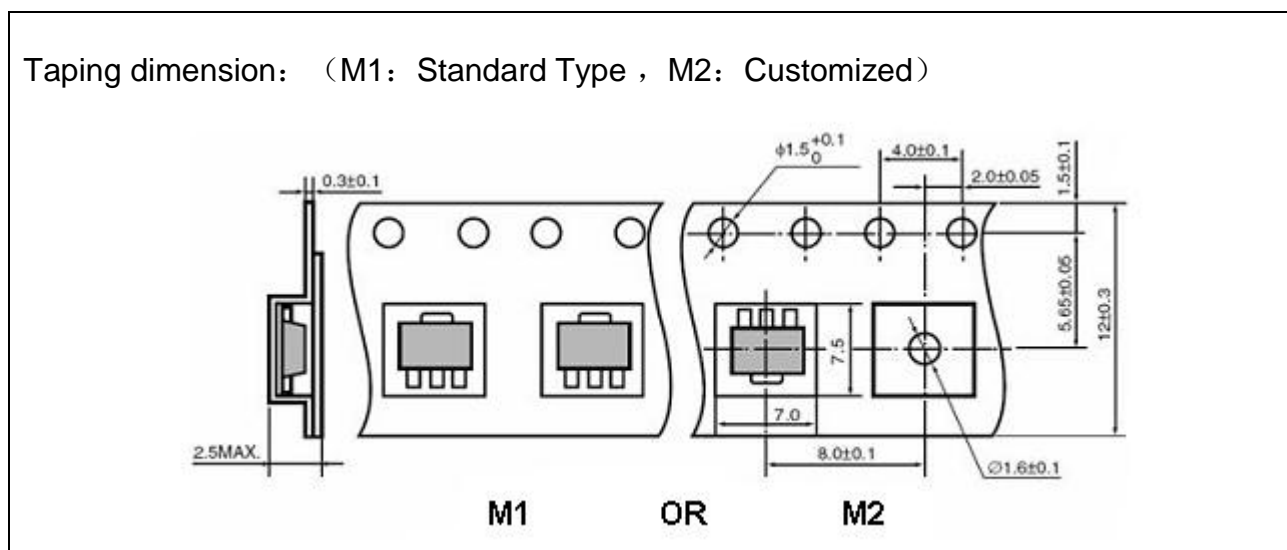

Taping reel dimension:

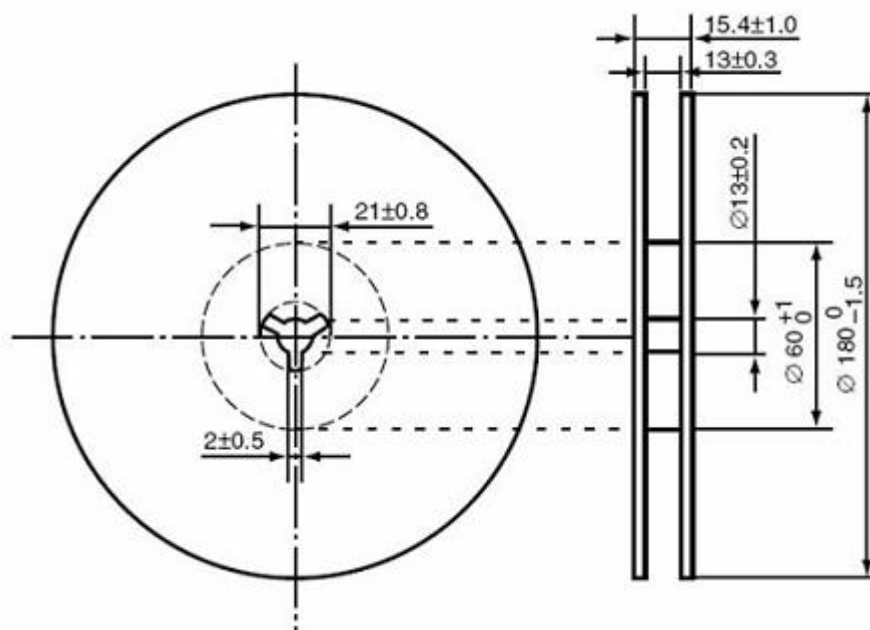

Package	TO-252	Devices per reel	2500	Unit	mm
---------	--------	------------------	------	------	----

Package specification:

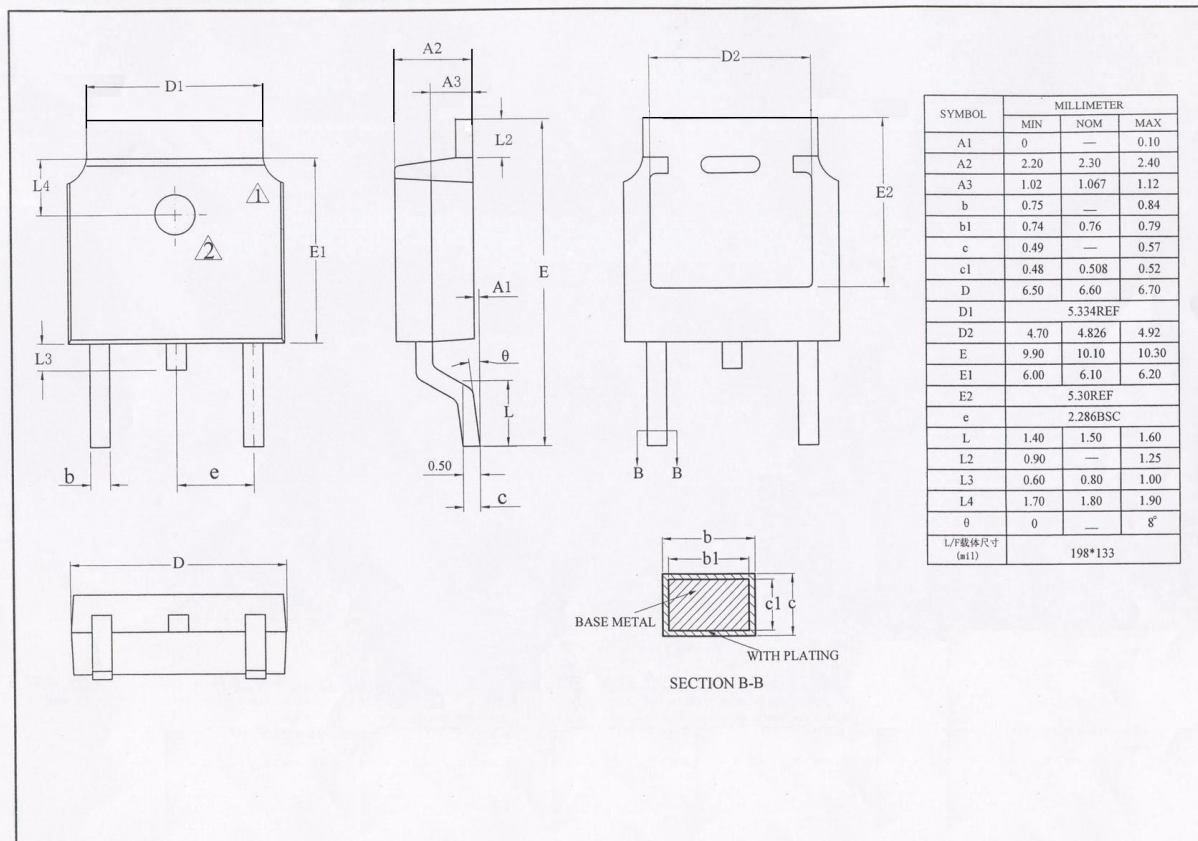

Taping dimension: (M1: Standard Type , M2: Customized)

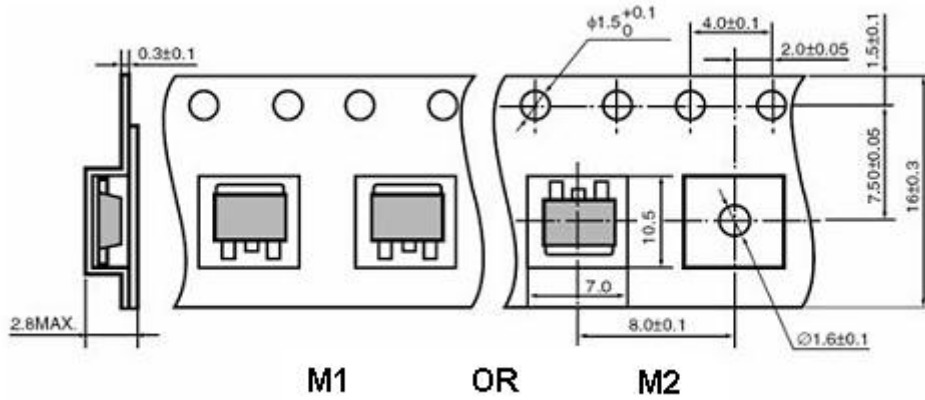

Taping reel dimension:

