

Description

The LM2575/6 series switching regulators are monolithic integrated circuits designed for use in “buck” or “buck/boost” regulator applications requiring accurate output voltages over combined variations of line, load and temperature. This unique series greatly simplifies switching power supply design. The LM2575 has a maximum output current of 1A and the LM2576 is rated for 3A.

The LM2575/6 series miniconverters include a switching regulator and compensation network all within the same package. Just add a choke, catch diode and two capacitors to obtain an efficient DC-to-DC converter. The current limit and thermal shutdown features of the LM2575/6 series fully protect the device against overstress conditions.

The LM2575/6 series offers an alternative to popular 3 terminal linear regulators by providing higher efficiency with reduced heatsink size. In many applications a heat sink will not be required.

Features

- ◆ Pin for pin replacement for National’s LM2575/6 series
- ◆ DC-to-DC buck or buck/boost converter requiring only 4 support components
- ◆ Fixed or adjustable voltages
- ◆ Preset output voltages of 3.3V, 5V and 12V
- ◆ Wide output voltage range, 1.23V to 35V
- ◆ 82% typical efficiency @ 5V out
- ◆ Wide input voltage range, 4V to 40V
- ◆ Inhibit/enable control pin
- ◆ Industrial temperature range
- ◆ TO-220 and TO-263 packages

Applications

- ◆ Micro controller power supplies
- ◆ Medical equipment
- ◆ Industrial power supplies
- ◆ Instrumentation power supplies

Typical Application Circuits

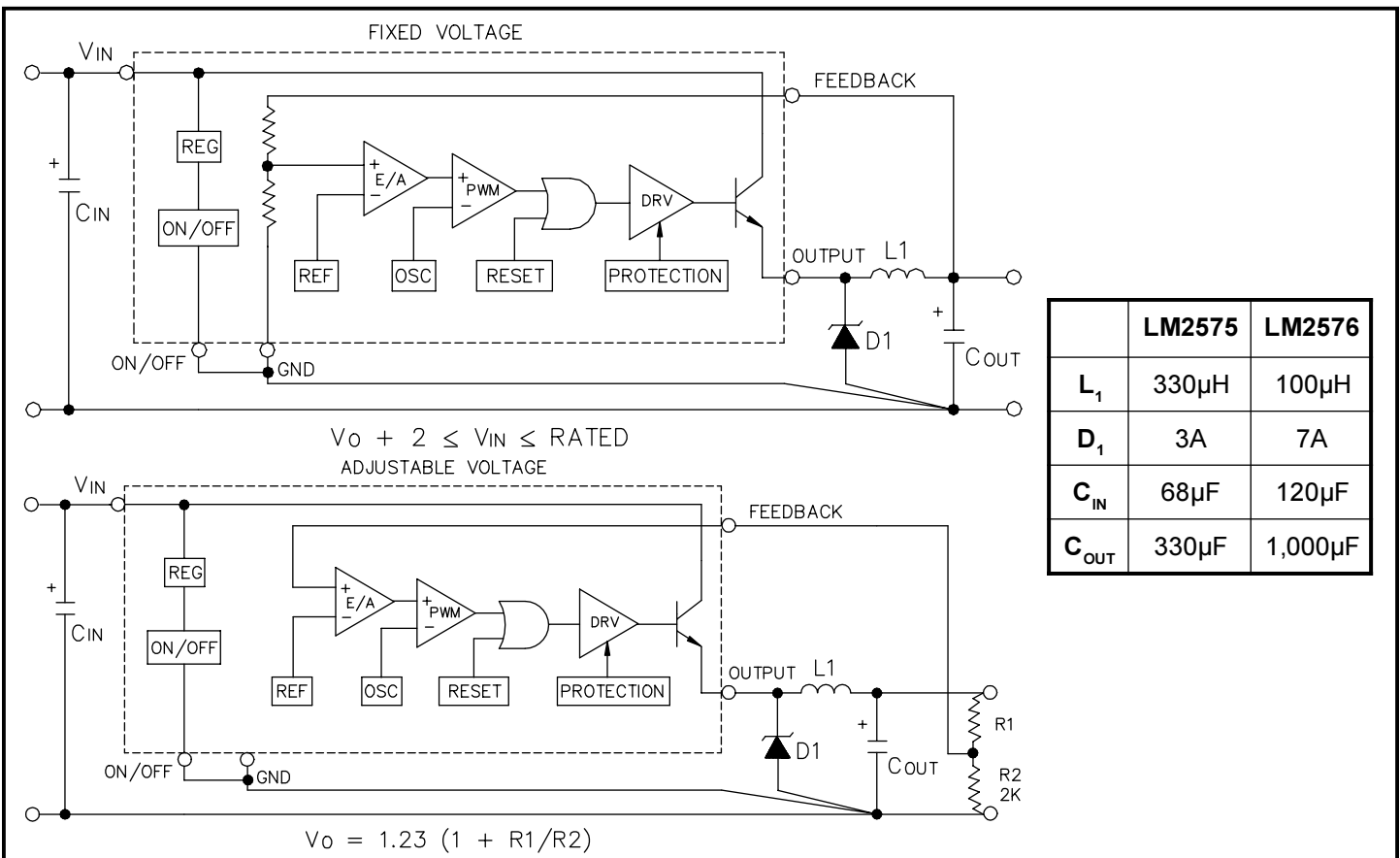

Absolute Maximum Ratings

| Parameter | Symbol | Maximum | Units |
|--|---------------|------------------------------------|-------|
| Input Voltage | V_{IN} | 45 | V |
| On/Off Pin Input Voltage | $V_{ON/OFF}$ | $-0.3 \leq V_{ON/OFF} \leq V_{IN}$ | V |
| Output Voltage to Common (Steady State) | | -1 | V |
| Power Dissipation | P_D | Internally Limited | W |
| Thermal Resistance Junction to Ambient TO-220 TO-263 | θ_{JA} | 55 60 | °C/W |
| Thermal Resistance Junction to Case TO-220 TO-263 | θ_{JC} | 2.0 2.0 | °C/W |
| Operating Junction Temperature Range | T_J | -40 to +125 | °C |
| Storage Temperature Range | T_{STG} | -65 to +150 | °C |
| Lead Temperature (Soldering) 10 Sec. | T_{LEAD} | 300 | °C |
| ESD Rating (Human Body Model) | V_{ESD} | 2 | kV |

Electrical Characteristics

Unless otherwise specified: $V_{IN} = 12V$ for 3.3V, 5V and ADJ options and 25V for 12V option; $V_{OUT} = 5V$ for ADJ option; $T_A = 25^\circ C$; V_{IN} rated = 40V; $I_O = 0.5$ to 3A (LM2576), 0.2 to 1A (LM2575). Values in **bold** apply over full operating temperature range.

| Parameter | Symbol | Test Conditions | Min | Typ | Max | Units |
|---|----------|----------------------------|--------------|-------|--------------|-------|
| Output Voltage LM2576S-3.3 | V_O | $I_O = 0.5A$ | 3.23 | 3.30 | 3.37 | V |
| | | 8V to V_{IN} Rated | 3.20 | | 3.40 | |
| | | | 3.14 | | 3.47 | |
| Output Voltage LM2576S-5.0 | V_O | $I_O = 0.5A$ | 4.90 | 5.00 | 5.10 | V |
| | | 8V to V_{IN} Rated | 4.85 | | 5.15 | |
| | | | 4.75 | | 5.25 | |
| Output Voltage LM2576-12 | V_O | $I_O = 0.5A$ | 11.76 | 12.00 | 12.24 | V |
| | | 15V to V_{IN} Rated | 11.52 | | 12.48 | |
| | | | 11.40 | | 12.60 | |
| Feedback Voltage LM2576S-ADJ, $V_O = 5V$ | V_{FB} | $I_O = 0.5A$ | 1.217 | 1.230 | 1.243 | V |
| | | 8V to V_{IN} Rated | 1.193 | | 1.267 | |
| | | | 1.180 | | 1.280 | |
| Feedback Bias Current LM2576S-ADJ | I_B | $V_{IN} = 12V, I_O = 0.5A$ | | 50 | 100 | nA |
| | | | | | 500 | |

Electrical Characteristics (Cont.)

Unless otherwise specified: $V_{IN} = 12V$ for 3.3V, 5V and ADJ options and 25V for 12V option; $V_{OUT} = 5V$ for ADJ option; $T_A = 25^\circ C$; V_{IN} rated = 40V; $I_o = 0.5$ to 3A (LM2576), 0.2 to 1A (LM2575). Values in **bold** apply over full operating temperature range.

| Parameter | Symbol | Test Conditions | Min | Typ | Max | Units |
|---|-----------|--|--|------------|--------------|-------|
| Output Voltage LM2575S-3.3 | V_o | $I_o = 0.2A$ | 3.23 | 3.30 | 3.37 | V |
| | | 8V to V_{IN} Rated | 3.20 | | 3.40 | |
| | | | 3.14 | | 3.47 | |
| Output Voltage LM2575S-5.0 | V_o | $I_o = 0.2A$ | 4.90 | 5.00 | 5.10 | V |
| | | 8V to V_{IN} Rated | 4.85 | | 5.15 | |
| | | | 4.75 | | 5.25 | |
| Output Voltage LM2575-12 | V_o | $I_o = 0.2A$ | 11.76 | 12.00 | 12.24 | V |
| | | 15V to V_{IN} Rated | 11.52 | | 12.48 | |
| | | | 11.40 | | 12.60 | |
| Feedback Voltage LM2575S-ADJ, $V_o = 5V$ | V_{FB} | $I_o = 0.2A$ | 1.217 | 1.230 | 1.243 | V |
| | | 8V to V_{IN} Rated | 1.193 | | 1.267 | |
| | | | 1.180 | | 1.280 | |
| Feedback Bias Current LM2575S-ADJ | I_B | $V_{IN} = 12V, I_o = 0.2A$ | | 50 | 100 | nA |
| | | | 500 | | | |
| Efficiency/Option 3.3V 5V 12V ADJ, $V_o = 5V$ | η | $V_{IN} = 12V, I_o = 1A$ (LM2575, 3A for LM2576) | | 77 | | % |
| | | | | 82 | | |
| | | $V_{IN} = 15V, I_o = 1A$ (LM2575, 3A for LM2576) | | 88 | | |
| | | | $V_{IN} = 12V, I_o = 1A$ (LM2575, 3A for LM2576) | | 82 | |
| Switching Frequency | f_{SX} | | 47 | 52 | 58 | kHz |
| | | | 43 | | 62 | |
| Saturation Voltage ⁽¹⁾ | V_{SAT} | LM2575, $I_o = 1A$ | | 0.9 | 1.2 | V |
| | | LM2576, $I_o = 3A$ | | 0.9 | 1.4 | |
| Max. Duty Cycle (On) ⁽³⁾ | DC | | 93 | 98 | | % |
| Peak Current LM2575 ⁽¹⁾ | I_{CL} | | 1.7 | 2.2 | 3.0 | A |
| | | | 1.3 | | 3.2 | |
| Peak Current LM2576 ⁽¹⁾ | I_{CL} | | 4.2 | 5.8 | 6.9 | A |
| | | | 3.5 | | 7.5 | |

Electrical Characteristics (Cont.)

Unless otherwise specified: $V_{IN} = 12V$ for 3.3V, 5V and ADJ options and 25V for 12V option; $V_{OUT} = 5V$ for ADJ option; $T_A = 25^\circ C$; $V_{IN\ rated} = 40V$; $I_O = 0.5$ to 3A (LM2576), 0.2 to 1A (LM2575). Values in **bold** apply over full operating temperature range.

| Parameter | Symbol | Test Conditions | Min | Typ | Max | Units |
|--|------------|--------------------------|------------|-----|------------|---------|
| Output Leakage Current ⁽²⁾ | I_L | $V_{IN} = V_{IN\ Rated}$ | | | 2 | mA |
| Output = 0V | | | | 7.5 | 30 | |
| Output = -1V | | | | | | |
| Quiescent Current ⁽²⁾ | I_Q | | | 5 | 10 | mA |
| | | | | | 12 | |
| Standby Quiescent Current (On/Off Pin = 5V) | I_{STBY} | | | 50 | | μA |
| | | | | | 500 | |
| On/Off Pin Logic Input Level | V_{IH} | | 2.2 | 1.4 | | V |
| | | | 2.4 | | | |
| | V_{IL} | | | 1.2 | 1.0 | V |
| | | | | | 0.8 | |
| On/Off Pin Input Current | I_{IH} | $V_{ON/OFF} = 5V$ (Off) | | 12 | 30 | μA |
| | I_{IL} | $V_{ON/OFF} = 0V$ (On) | | 0 | 10 | |

Notes:

- (1) Output sourcing current, resistive load, no inductor or capacitor.
- (2) Feedback = $V_O + 1.0V$.
- (3) Feedback = 0V.

Pin Configurations

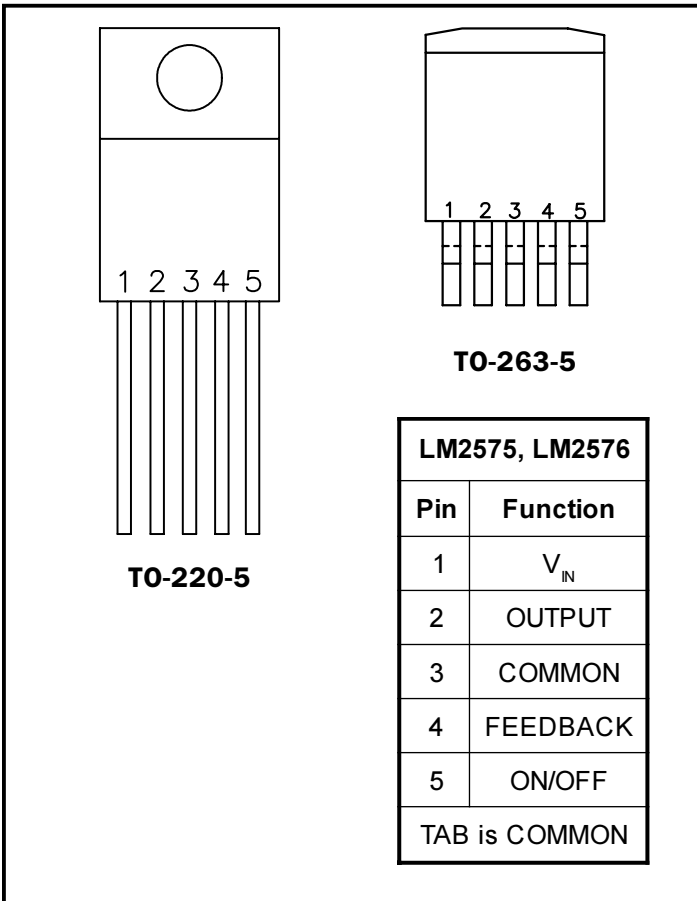

Ordering Information

(1) -XX = Voltage Option. Available voltages are 3.3V (-3.3), 5V (-5.0), 12V (-12), and ADJ (-ADJ), which is adjustable between 1.23V and 35V.

Block Diagram

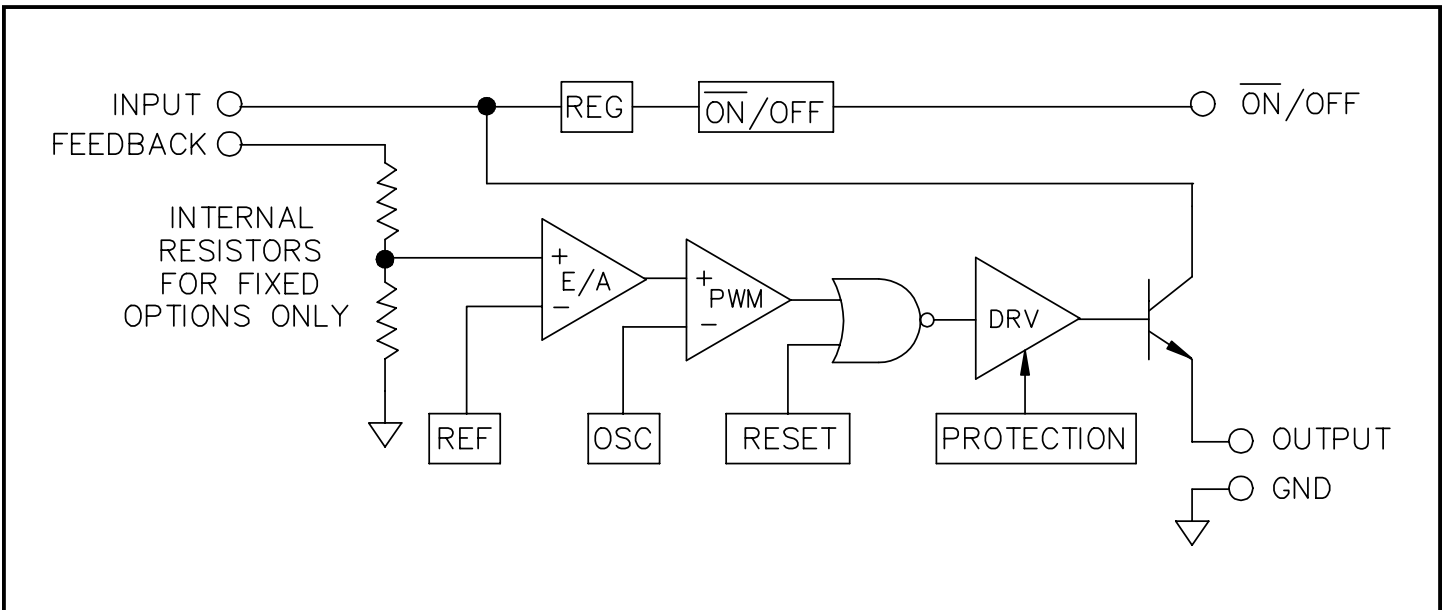

Typical Characteristics - LM2575

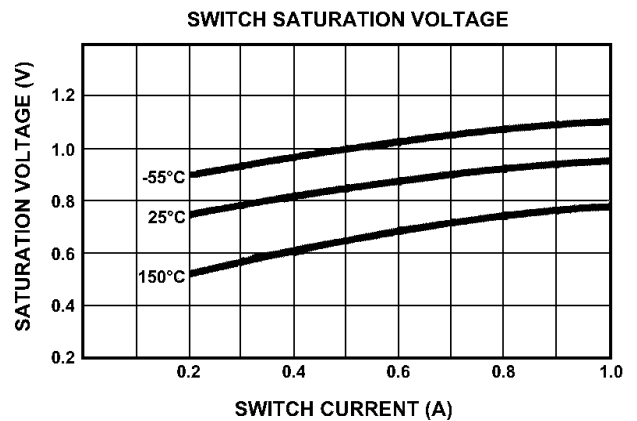
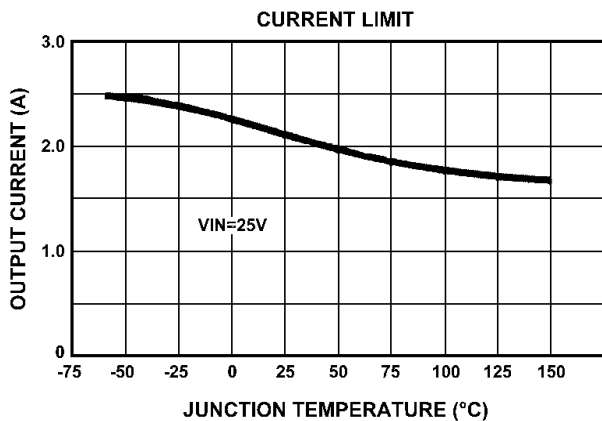
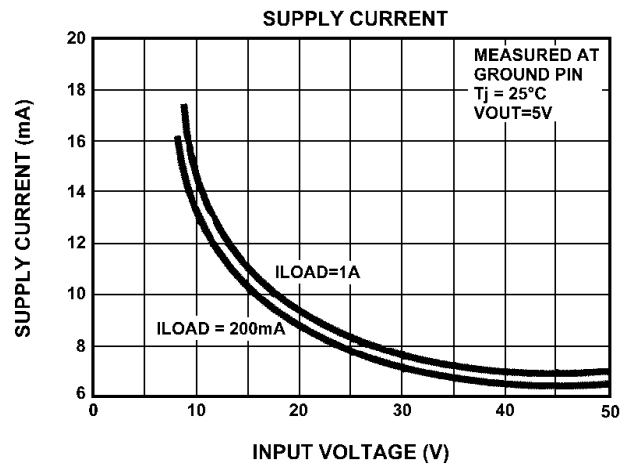
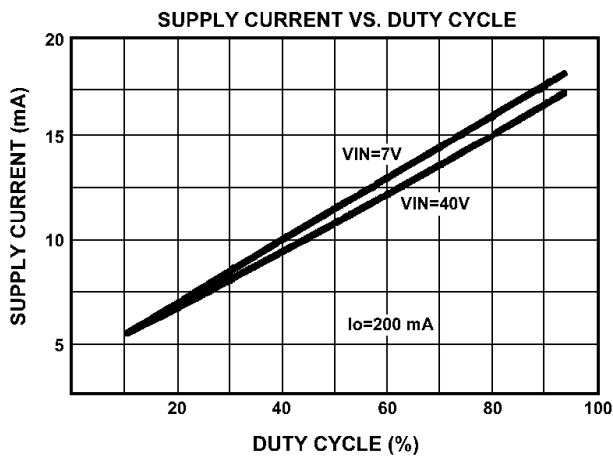
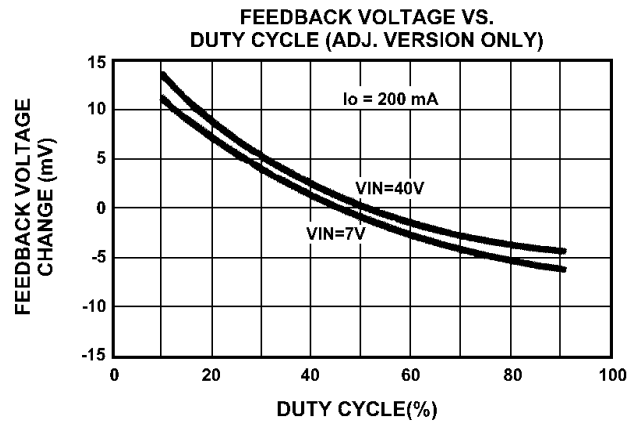
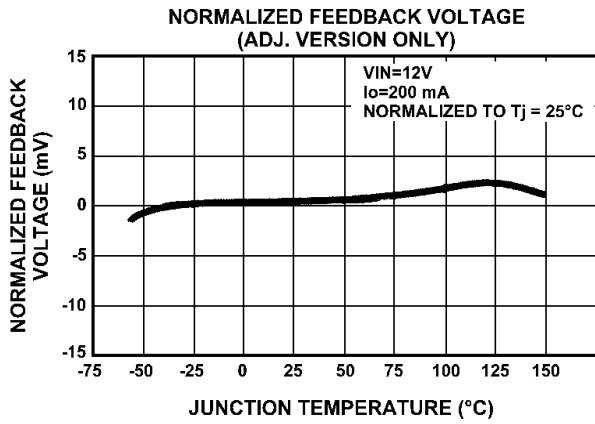

Typical Characteristics - LM2575 (Cont.)

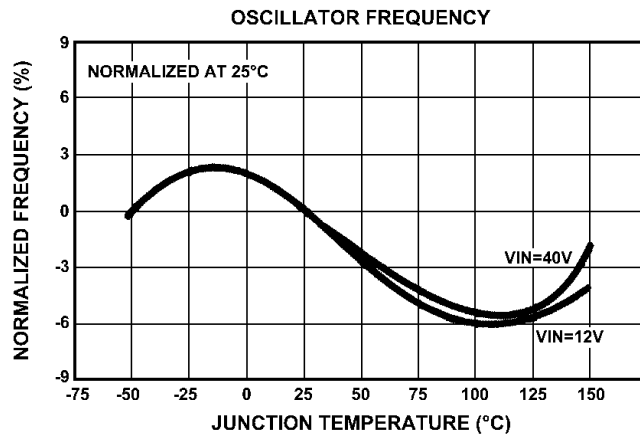
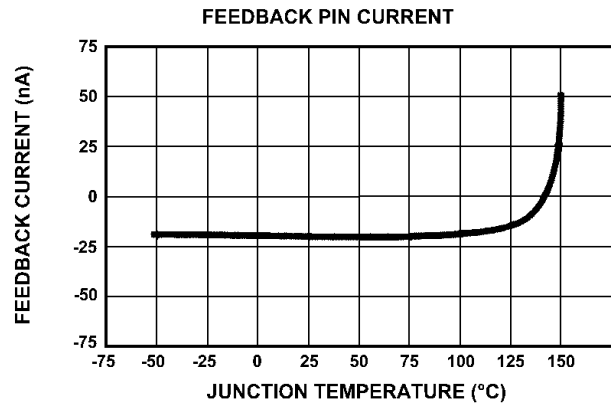
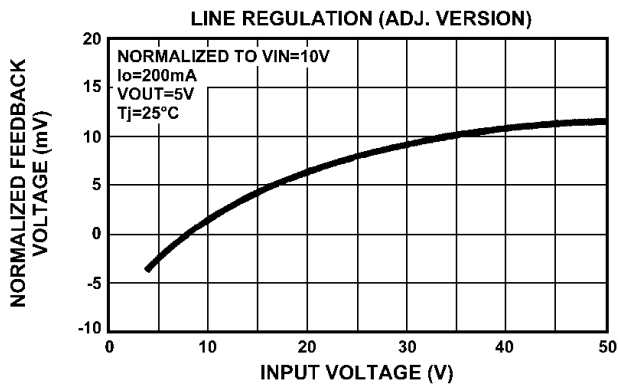
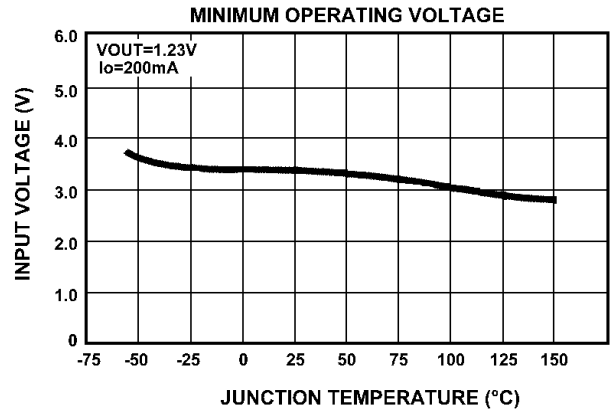
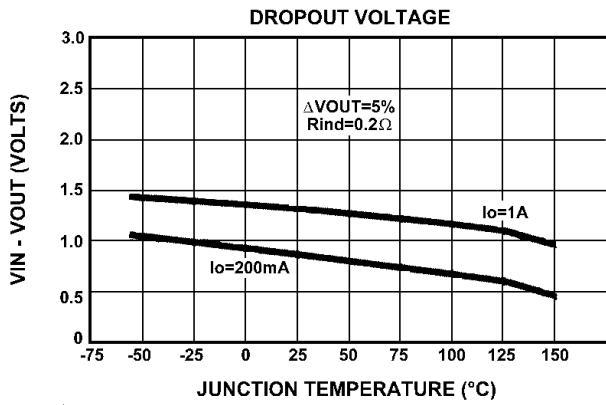

Typical Characteristics - LM2575 (Cont.)

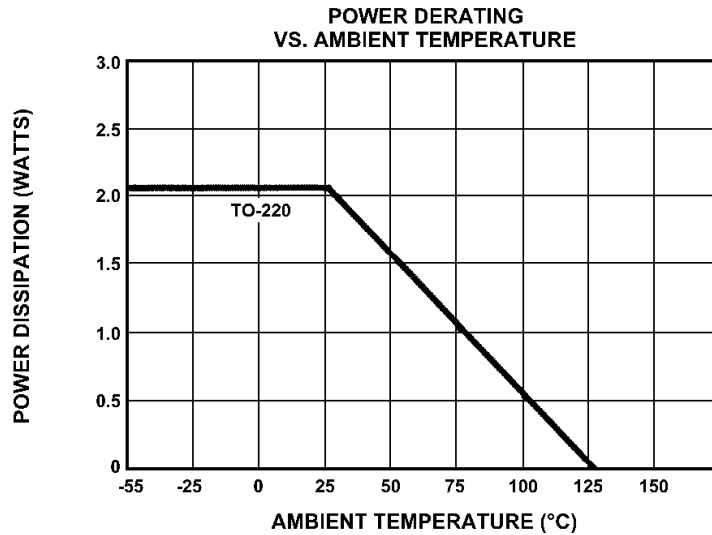
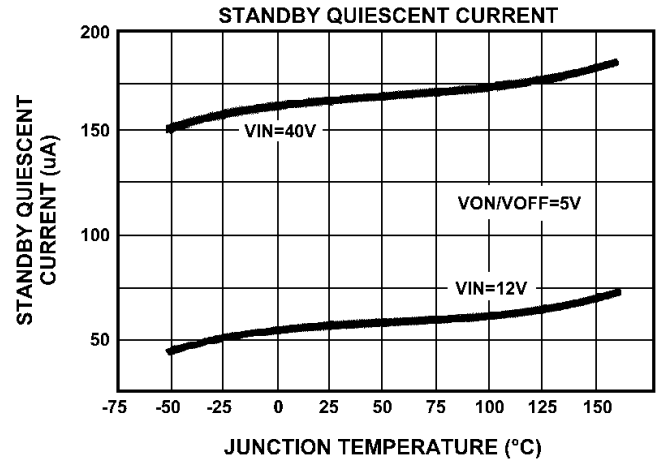
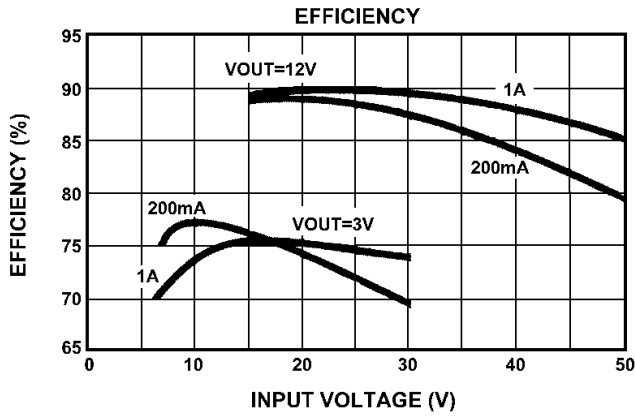

Typical Characteristics - LM2576

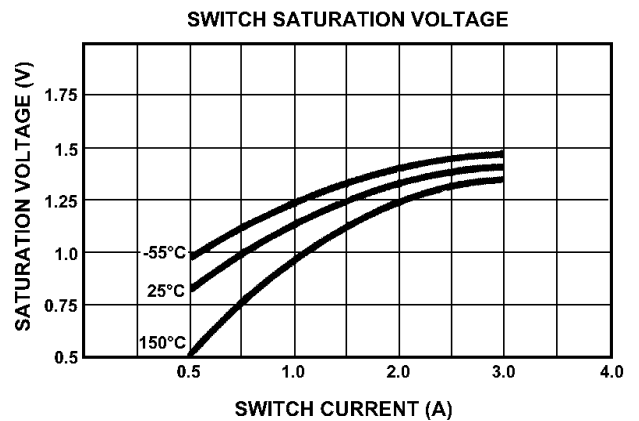
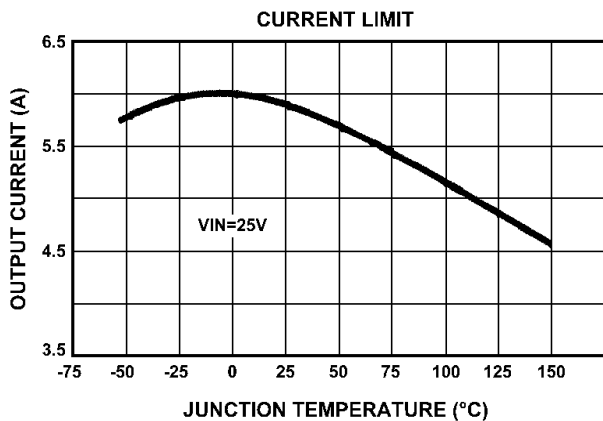
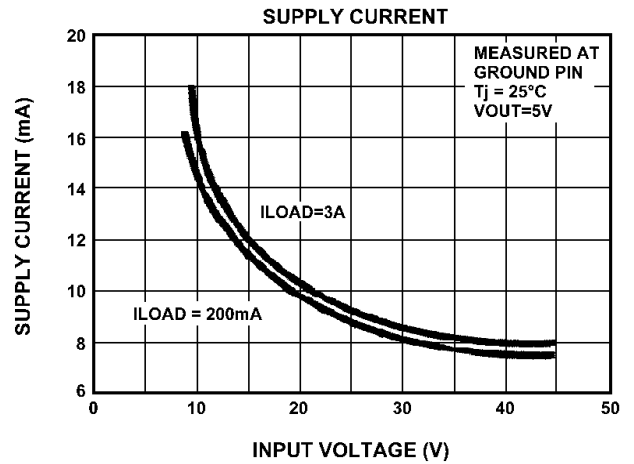
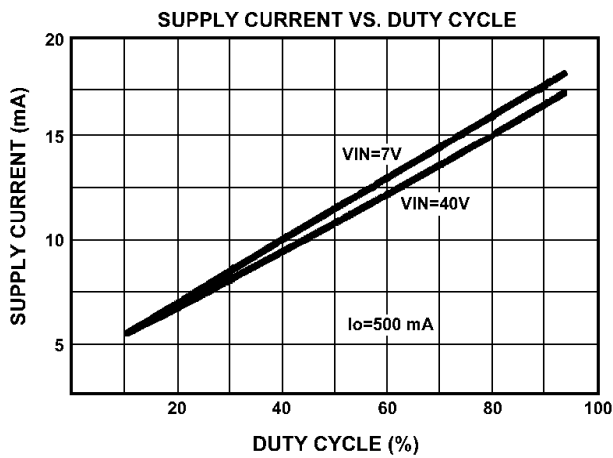
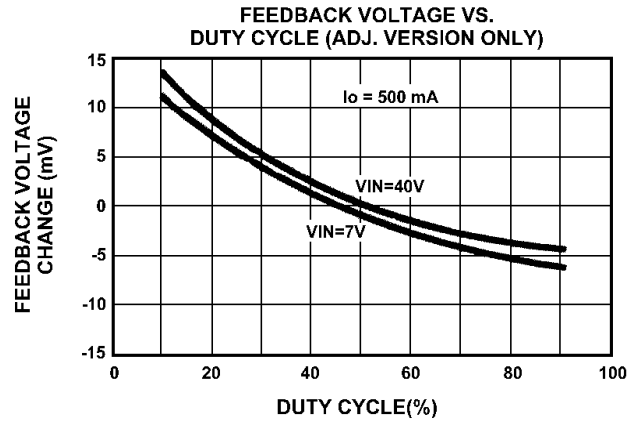
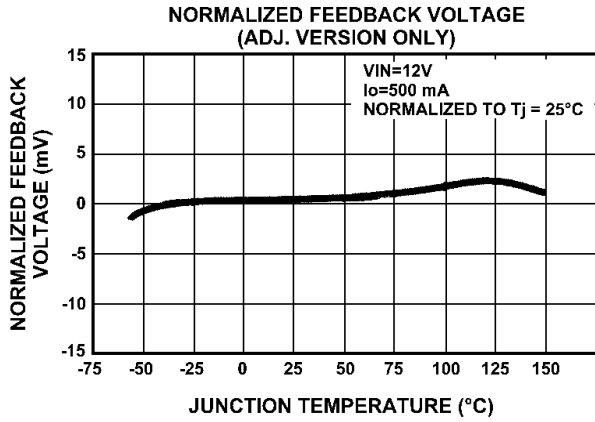

Typical Characteristics - LM2576 (Cont.)

DROPOUT VOLTAGE

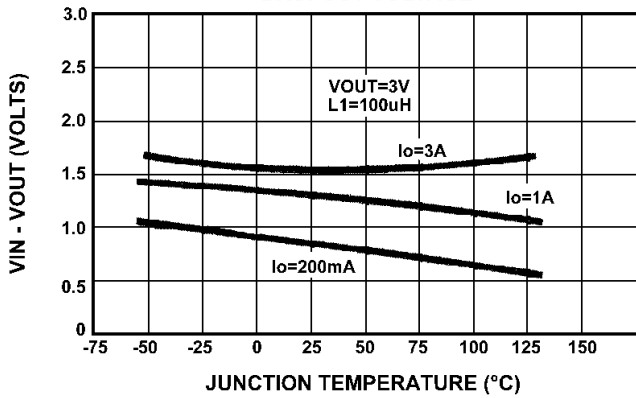

MINIMUM OPERATING VOLTAGE

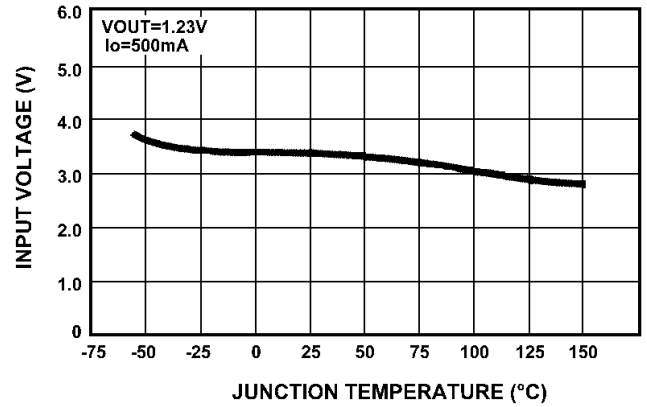

LINE REGULATION (ADJ. VERSION)

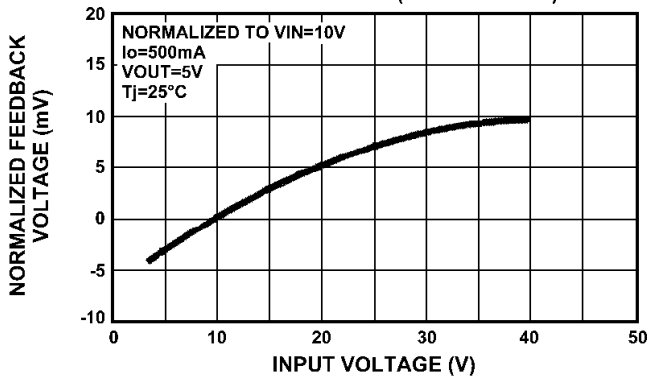

FEEDBACK PIN CURRENT

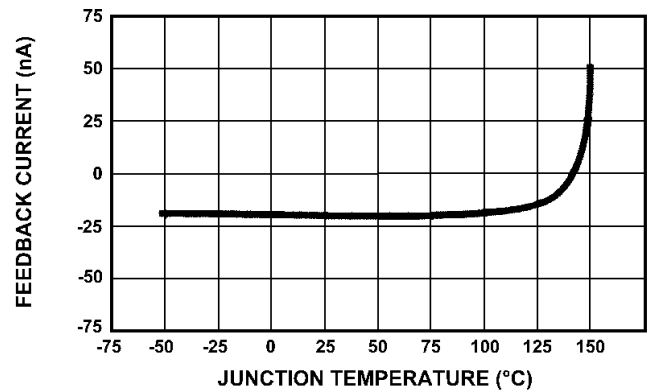

OSCILLATOR FREQUENCY

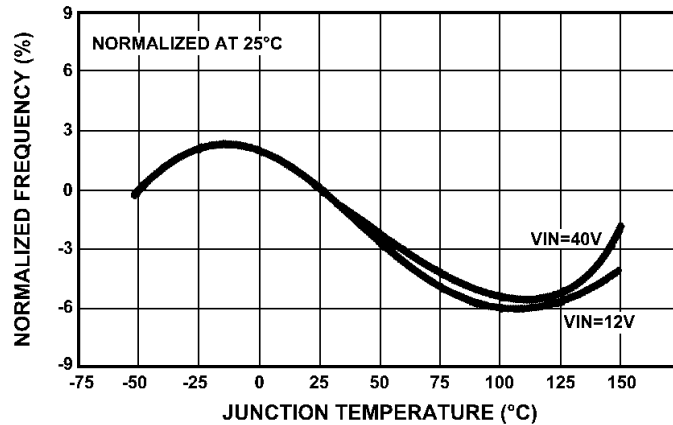

Typical Characteristics - LM2576 (Cont.)

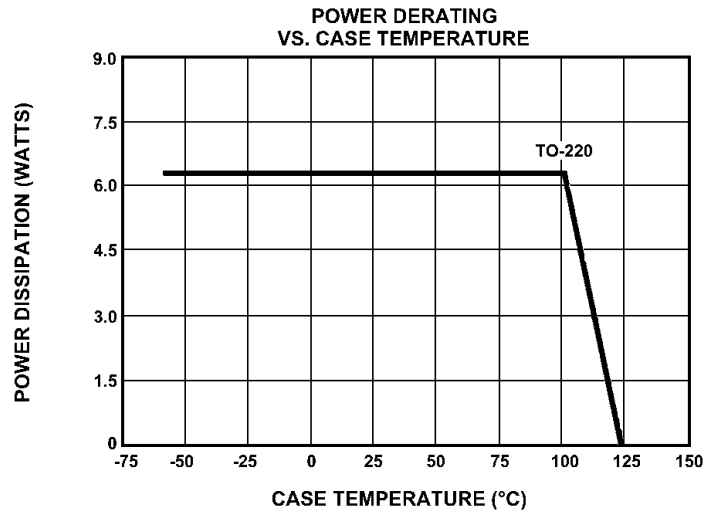
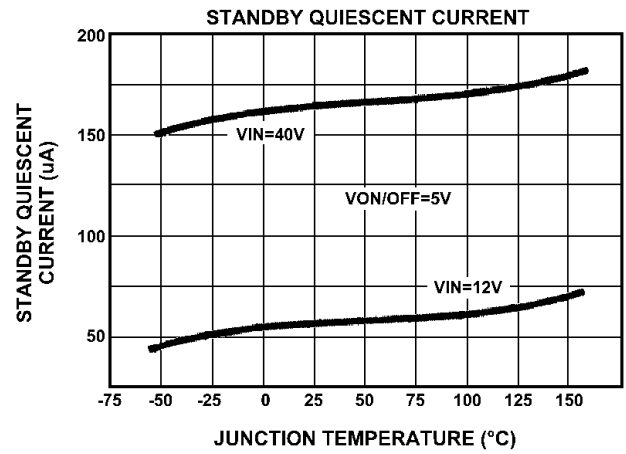
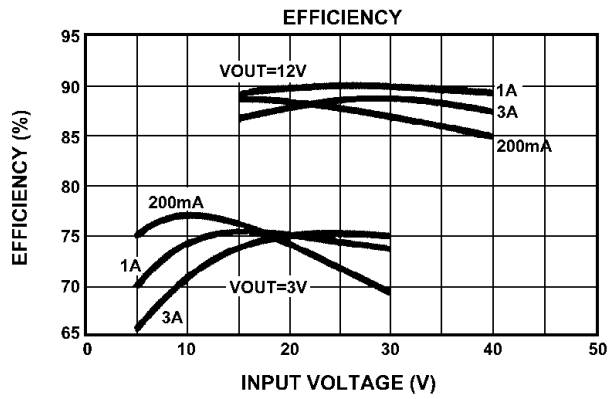

Outline Drawing - TO-220-5

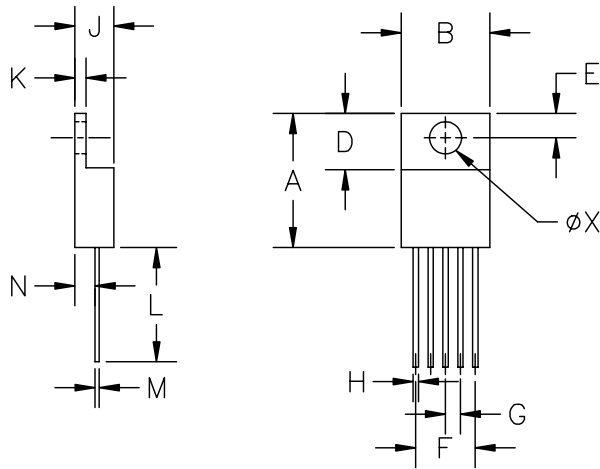

| DIM ^N | INCHES | | MM | | NOTE |
|------------------|--------|------|-------|-------|------|
| | MIN | MAX | MIN | MAX | |
| A | .560 | .650 | 14.22 | 16.51 | — |
| B | .380 | .420 | 9.65 | 10.67 | — |
| D | .230 | .260 | 5.84 | 6.60 | — |
| E | .100 | .135 | 2.54 | 3.43 | — |
| F | .263 | .273 | 6.68 | 6.94 | — |
| G | .062 | .072 | 1.57 | 1.83 | — |
| H | .025 | .040 | .63 | 1.02 | — |
| J | .140 | .190 | 3.55 | 4.83 | — |
| K | .045 | .055 | 1.14 | 1.40 | — |
| L | .540 | .560 | 13.72 | 14.22 | — |
| M | .014 | .022 | .35 | .56 | — |
| N | .080 | .120 | 2.03 | 3.05 | — |
| ϕX | .139 | .161 | 3.53 | 4.09 | — |

JEDEC TO-220

Outline Drawing - TO-263-5

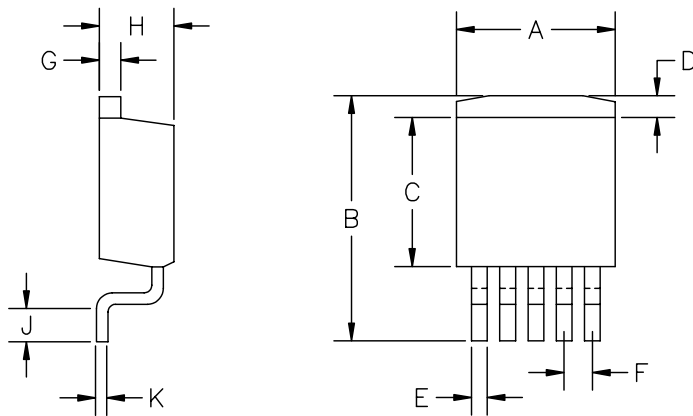

| DIM ^N | INCHES | | MM | | NOTE |
|------------------|--------|------|-------|-------|------|
| | MIN | MAX | MIN | MAX | |
| A | .380 | .405 | 9.65 | 10.29 | — |
| B | .575 | .625 | 14.60 | 15.88 | — |
| C | .325 | .380 | 8.25 | 9.66 | — |
| D | — | .055 | — | 1.40 | — |
| E | .020 | .039 | .50 | .99 | — |
| F | .060 | .072 | 1.52 | 1.83 | — |
| G | .045 | .055 | 1.14 | 1.40 | — |
| H | .160 | .190 | 4.06 | 4.83 | — |
| J | .090 | .110 | 2.28 | 2.80 | — |
| K | .018 | .029 | .457 | .736 | — |

JEDEC TO-263

Minimum Land Pattern - TO-263-5

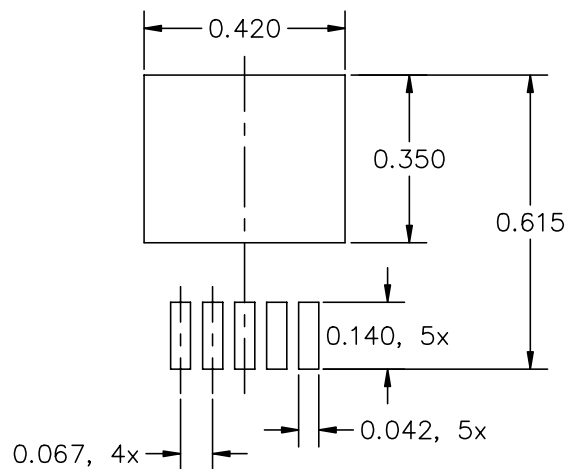

NOTE: ALL DIMENSIONS ARE IN INCHES