

# MJE350G

## Plastic Medium-Power PNP Silicon Transistor

This device is designed for use in line-operated applications such as low power, line-operated series pass and switching regulators requiring PNP capability.

### Features

- High Collector-Emitter Sustaining Voltage
- Excellent DC Current Gain
- Complement to MJE340
- These Devices are Pb-Free and are RoHS Compliant\*

### MAXIMUM RATINGS

Rating	Symbol	Value	Unit
Collector-Emitter Voltage	$V_{CEO}$	300	Vdc
Emitter-Base Voltage	$V_{EB}$	3.0	Vdc
Collector Current - Continuous	$I_C$	500	mAdc
Total Power Dissipation @ $T_C = 25^\circ\text{C}$ Derate above $25^\circ\text{C}$	$P_D$	20 0.16	W mW/ $^\circ\text{C}$
Operating and Storage Junction Temperature Range	$T_J, T_{stg}$	-65 to +150	$^\circ\text{C}$

Stresses exceeding those listed in the Maximum Ratings table may damage the device. If any of these limits are exceeded, device functionality should not be assumed, damage may occur and reliability may be affected.

### THERMAL CHARACTERISTICS

Characteristic	Symbol	Max	Unit
Thermal Resistance, Junction-to-Case	$R_{\theta JC}$	6.25	$^\circ\text{C/W}$

### ELECTRICAL CHARACTERISTICS ( $T_C = 25^\circ\text{C}$ unless otherwise noted)

Characteristic	Symbol	Min	Max	Unit
----------------	--------	-----	-----	------

### OFF CHARACTERISTICS

Collector-Emitter Sustaining Voltage ( $I_C = 1.0 \text{ mAdc}, I_B = 0$ )	$V_{CEO(sus)}$	300	-	Vdc
Collector Cutoff Current ( $V_{CB} = 300 \text{ Vdc}, I_E = 0$ )	$I_{CBO}$	-	100	$\mu\text{Adc}$
Emitter Cutoff Current ( $V_{EB} = 3.0 \text{ Vdc}, I_C = 0$ )	$I_{EBO}$	-	100	$\mu\text{Adc}$

### ON CHARACTERISTICS

DC Current Gain ( $I_C = 50 \text{ mAdc}, V_{CE} = 10 \text{ Vdc}$ )	$h_{FE}$	30	240	-
---	----------	----	-----	---

Product parametric performance is indicated in the Electrical Characteristics for the listed test conditions, unless otherwise noted. Product performance may not be indicated by the Electrical Characteristics if operated under different conditions.

\*For additional information on our Pb-Free strategy and soldering details, please download the ON Semiconductor Soldering and Mounting Techniques Reference Manual, SOLDERRM/D.



**ON Semiconductor®**

[www.onsemi.com](http://www.onsemi.com)

**0.5 AMPERE  
POWER TRANSISTOR  
PNP SILICON  
300 VOLTS, 20 WATTS**

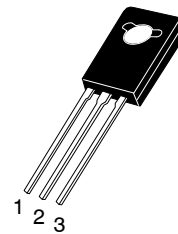
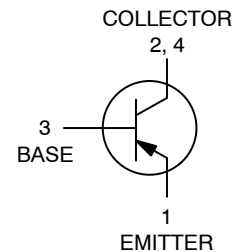

TO-225  
CASE 77-09  
STYLE 1

### MARKING DIAGRAM

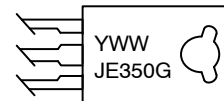

Y = Year  
WW = Work Week  
JE350 = Device Code  
G = Pb-Free Package

### ORDERING INFORMATION

Device	Package	Shipping
MJE350G	TO-225 (Pb-Free)	500 Units/Box

# MJE350G

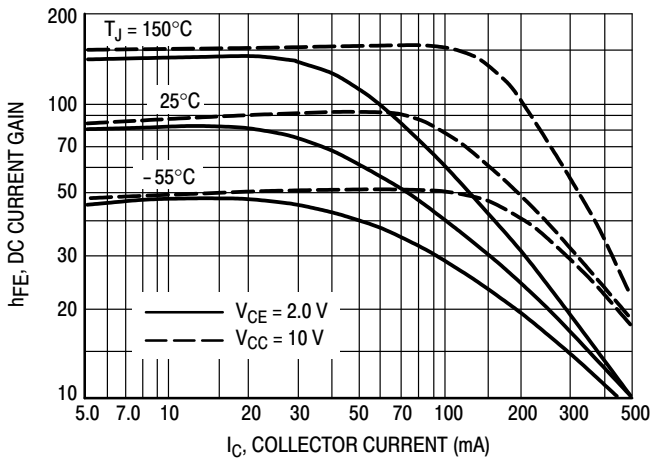

Figure 1. DC Current Gain

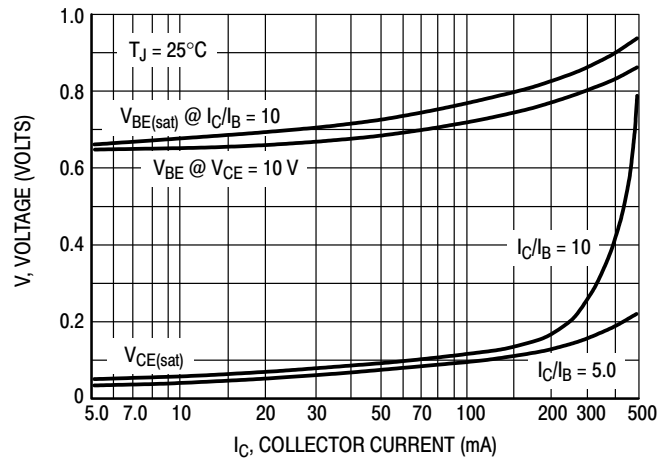

Figure 2. "On" Voltages

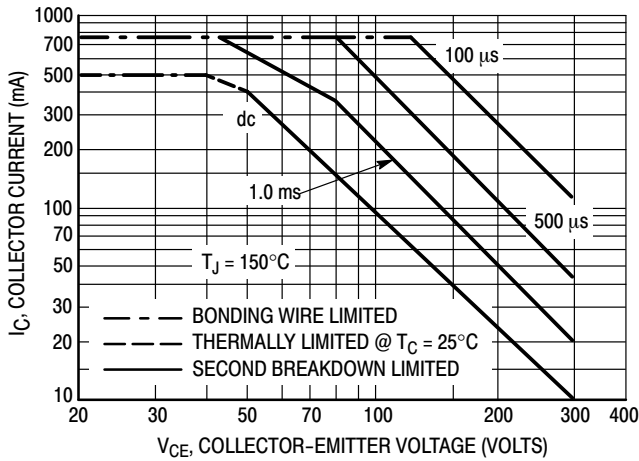

Figure 3. Active-Region Safe Operating Area

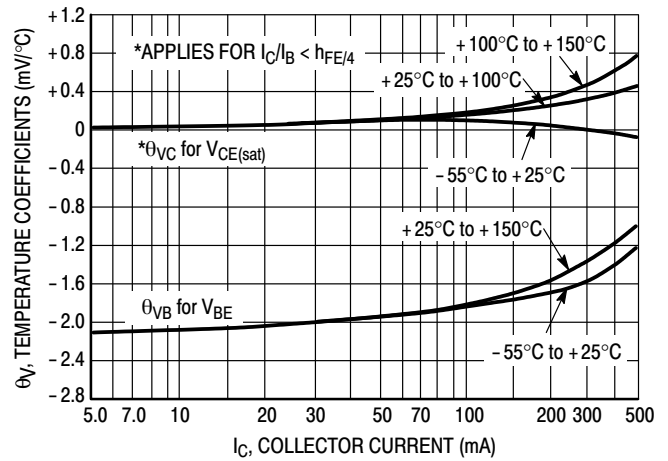

Figure 4. Temperature Coefficients

There are two limitations on the power handling ability of a transistor: average junction temperature and second breakdown. Safe operating area curves indicate  $I_C - V_{CE}$  limits of the transistor that must be observed for reliable operation; i.e., the transistor must not be subjected to greater dissipation than the curves indicate.

The data of Figure 3 is based on  $T_{J(pk)} = 150^\circ\text{C}$ ;  $T_C$  is variable depending on conditions. Second breakdown pulse limits are valid for duty cycles to 10% provided  $T_{J(pk)} \leq 150^\circ\text{C}$ . At high case temperatures, thermal limitations will reduce the power that can be handled to values less than the limitations imposed by second breakdown.

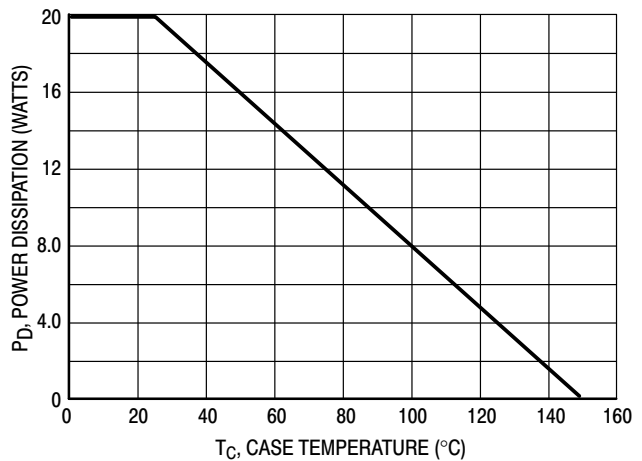
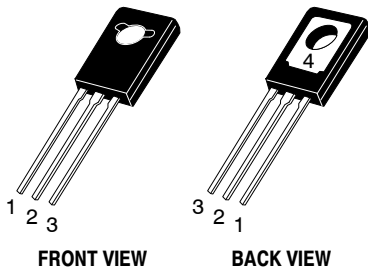

Figure 5. Power Derating

# MJE350G

## PACKAGE DIMENSIONS

TO-225  
CASE 77-09  
ISSUE AD



SCALE 1:1

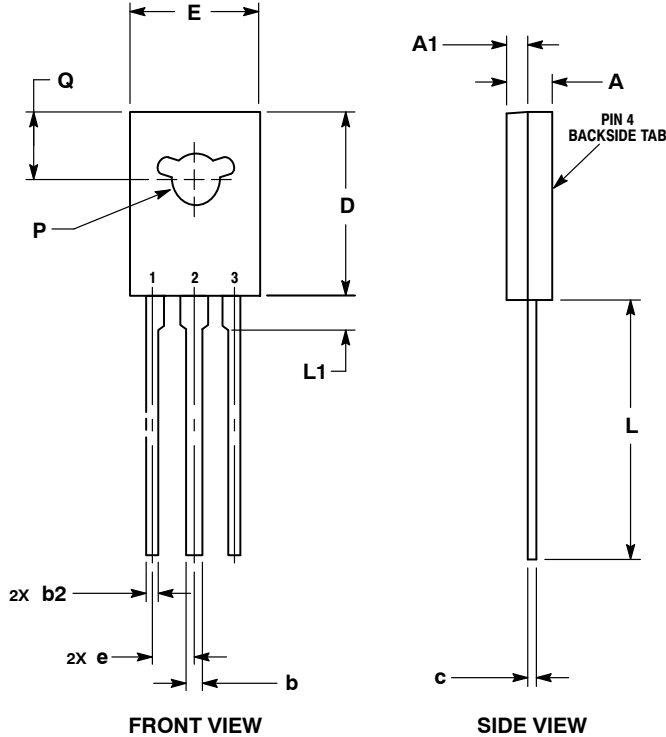

NOTES:

1. DIMENSIONING AND TOLERANCING PER ASME Y14.5M, 1994.
2. CONTROLLING DIMENSION: MILLIMETERS.
3. NUMBER AND SHAPE OF LUGS OPTIONAL.

MILLIMETERS		
DIM	MIN	MAX
A	2.40	3.00
A1	1.00	1.50
b	0.60	0.90
b2	0.51	0.88
c	0.39	0.63
D	10.60	11.10
E	7.40	7.80
e	2.04	2.54
L	14.50	16.63
L1	1.27	2.54
P	2.90	3.30
Q	3.80	4.20

STYLE 1:

- PIN 1. EMITTER
- 2., 4. COLLECTOR
3. BASE

ON Semiconductor and are trademarks of Semiconductor Components Industries, LLC dba ON Semiconductor or its subsidiaries in the United States and/or other countries. ON Semiconductor owns the rights to a number of patents, trademarks, copyrights, trade secrets, and other intellectual property. A listing of ON Semiconductor's product/patent coverage may be accessed at [www.onsemi.com/site/pdf/Patent-Marking.pdf](http://www.onsemi.com/site/pdf/Patent-Marking.pdf). ON Semiconductor reserves the right to make changes without further notice to any products herein. ON Semiconductor makes no warranty, representation or guarantee regarding the suitability of its products for any particular purpose, nor does ON Semiconductor assume any liability arising out of the application or use of any product or circuit, and specifically disclaims any and all liability, including without limitation special, consequential or incidental damages. Buyer is responsible for its products and applications using ON Semiconductor products, including compliance with all laws, regulations and safety requirements or standards, regardless of any support or applications information provided by ON Semiconductor. "Typical" parameters which may be provided in ON Semiconductor data sheets and/or specifications can and do vary in different applications and actual performance may vary over time. All operating parameters, including "Typicals" must be validated for each customer application by customer's technical experts. ON Semiconductor does not convey any license under its patent rights nor the rights of others. ON Semiconductor products are not designed, intended, or authorized for use as a critical component in life support systems or any FDA Class 3 medical devices or medical devices with a same or similar classification in a foreign jurisdiction or any devices intended for implantation in the human body. Should Buyer purchase or use ON Semiconductor products for any such unintended or unauthorized application, Buyer shall indemnify and hold ON Semiconductor and its officers, employees, subsidiaries, affiliates, and distributors harmless against all claims, costs, damages, and expenses, and reasonable attorney fees arising out of, directly or indirectly, any claim of personal injury or death associated with such unintended or unauthorized use, even if such claim alleges that ON Semiconductor was negligent regarding the design or manufacture of the part. ON Semiconductor is an Equal Opportunity/Affirmative Action Employer. This literature is subject to all applicable copyright laws and is not for resale in any manner.

### PUBLICATION ORDERING INFORMATION

**LITERATURE FULFILLMENT:**

Literature Distribution Center for ON Semiconductor  
19521 E. 32nd Pkwy, Aurora, Colorado 80011 USA  
Phone: 303-675-2175 or 800-344-3860 Toll Free USA/Canada  
Fax: 303-675-2176 or 800-344-3867 Toll Free USA/Canada  
Email: [orderlit@onsemi.com](mailto:orderlit@onsemi.com)

**N. American Technical Support:** 800-282-9855 Toll Free  
USA/Canada  
**Europe, Middle East and Africa Technical Support:**  
Phone: 421 33 790 2910  
**Japan Customer Focus Center**  
Phone: 81-3-5817-1050

**ON Semiconductor Website:** [www.onsemi.com](http://www.onsemi.com)

**Order Literature:** <http://www.onsemi.com/orderlit>

For additional information, please contact your local Sales Representative