

1 Watt Audio Power Amplifier

DESCRIPTION

The EUA4890 is an audio power amplifier designed for portable communication device applications such as mobile phone applications. The EUA4890 is capable of delivering 1.0W of continuous average power to an 8Ω BTL and with less than 1% distortion (THD+N) from a 5.0V power supply, and 350mW to a 8Ω BTL load from a 3V power supply.

The EUA4890 provides high quality audio while requiring few external components and minimal power consumption. It features a low-power shutdown mode, which is achieved by driving the SHUTDOWN pin with logic low.

The EUA4890 contains circuitry to prevent from "pop and click" noise that would otherwise occur during turn-on and turn-off transitions.

For maximum flexibility, the EUA4890 provides an externally controlled gain (with resistors), as well as an externally controlled turn-on and turn-off times (with the bypass capacitor).

The EUA4890 is available in a MSOP-8 , 3mm×3mm DFN package.

FEATURES

- 2.5-5.5V operation
- 65dB PSRR at 217Hz, $V_{DD}=5V$
- 0.1μA ultra low current shutdown mode
- Improved pop & click circuitry
- No output coupling capacitors, snubber networks or bootstrap capacitors required
- Thermal shutdown protection
- Unity-gain stable
- External gain configuration capability
- BTL output can drive capacitive loads
- RoHS compliant and 100% lead(Pb)-free

APPLICATIONS

- Mobile Phones
- PDAs
- Portable electronic devices

Block Diagram

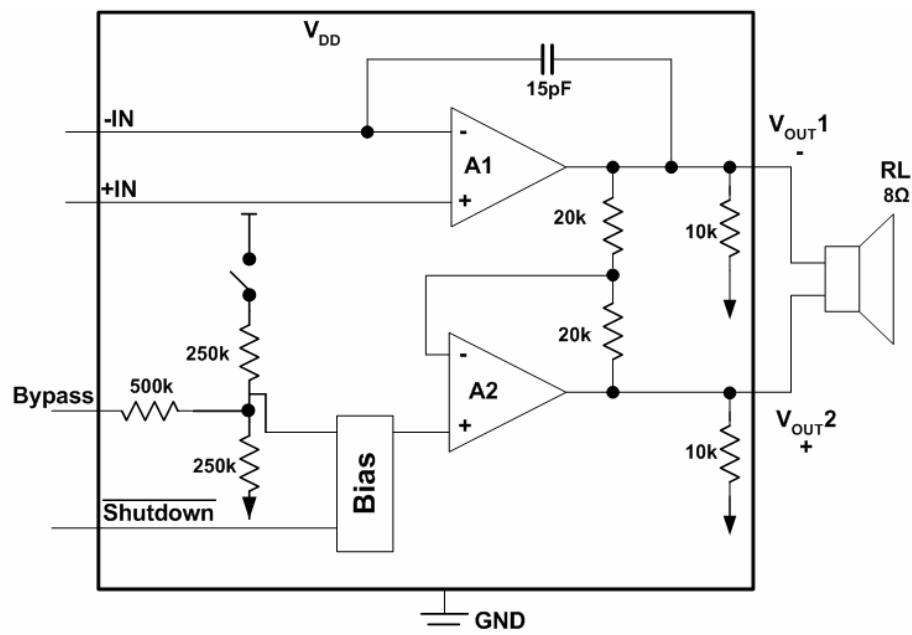

Figure1.

Typical Application Circuit

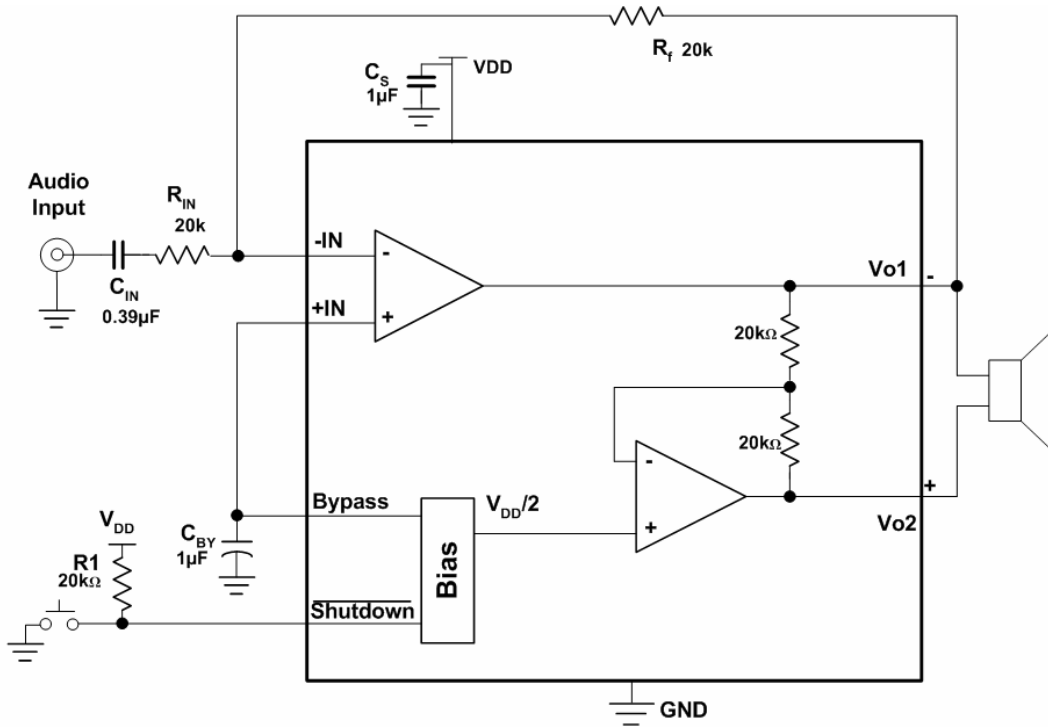

Figure2. Audio Amplifier with Single –Ended Input

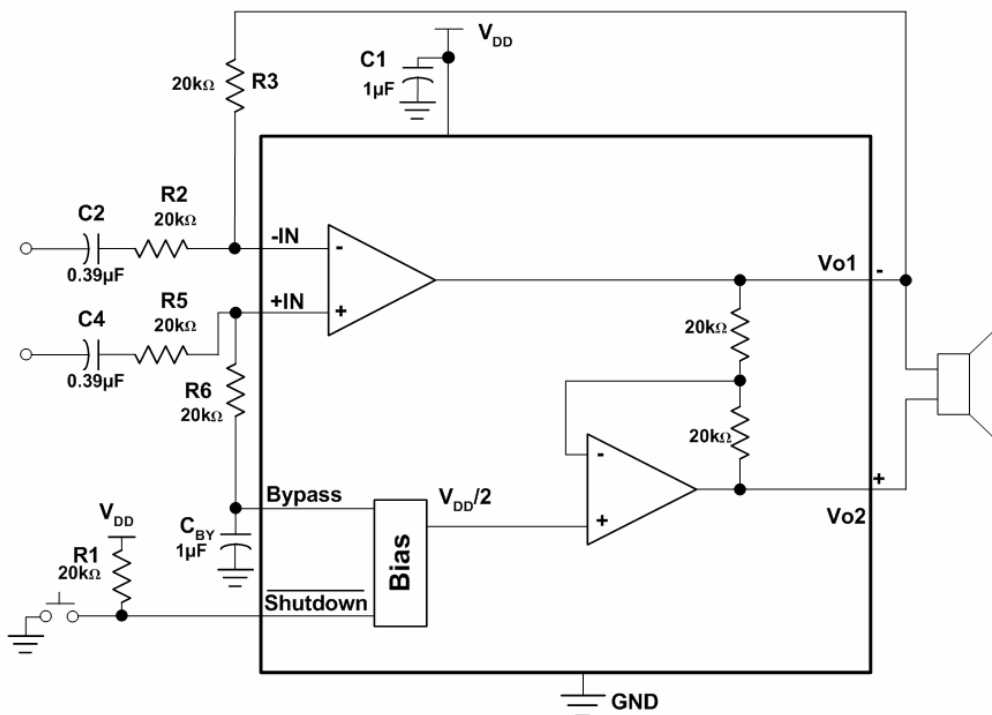

Figure3. Audio Amplifier with Differential Input

Pin Configurations

Package Type	Pin Configurations	Package Type	Pin Configurations
MSOP-8	<p>Top View</p>	DFN-8	<p>Top View</p>

Pin Description

PIN	PIN	I/O	DESCRIPTION
$\overline{\text{SHUTDOWN}}$	1	I	The device enters in shutdown mode when a low level is applied on this pin
BYPASS	2	I	Bypass capacitor pin which provides the common mode voltage
+IN	3	I	Positive input of the first amplifier, receives the common mode voltage
-IN	4	I	Negative input of the first amplifier, receives the audio input signal. Connected to the feedback resistor R_f and to the input resistor R_{in} .
V_{O1}	5	O	Negative output of the EUA4890. Connected to the load and to the feedback resistor R_f
V_{DD}	6	I	Analog V_{DD} input supply.
GND	7		Ground connection for circuitry.
V_{O2}	8	O	Positive output of the EUA4890.

Ordering Information

Order Number	Package Type	Marking	Operating Temperature range
EUA4890MIR1	MSOP-8	XXXX A4890	-40 °C to 85°C
EUA4890JIR1	DFN-8	XXXX A4890	-40 °C to 85°C

EUA4890

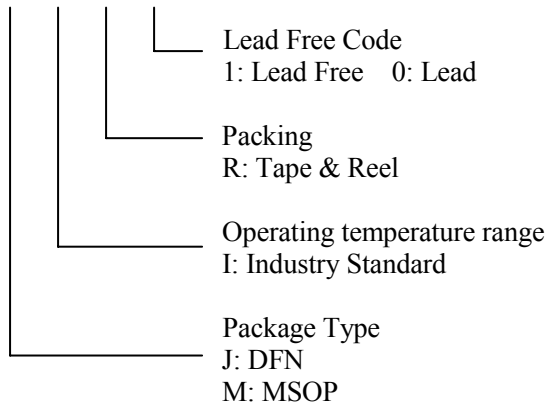

Absolute Maximum Ratings

Supply voltage, V_{DD}	-----	6V
Input voltage, V_I	-----	-0.3 V to V_{DD} +0.3V
Storage temperature rang, T_{stg}	-----	-65°C to 150°C
ESD Susceptibility	-----	2kV
Junction Temperature	-----	150°C
Thermal Resistance		
θ_{JC} (MSOP)	-----	56°C/W
θ_{JA} (MSOP)	-----	160°C/W
θ_{JA} (DFN)	-----	50°C/W

Electrical Characteristics $V_{DD} = 5V$, $T_A = 25^\circ C$

Symbol	Parameter	Conditions	EUA4890			Unit
			Min	Typ	Max.	
I_{DD}	Quiescent Power Supply Current	$V_{IN}=0V$, $I_O=0A$, No load		2.4	5	mA
		$V_{IN}=0V$, $I_O=0A$, 8 Ω load		2.5	5	mA
I_{SD}	Shutdown Current	$V_{SHUTDOWN}=0V$		0.1	2.0	μA
V_{SDIH}	Shutdown Voltage Input High		1.2			V
V_{SDIL}	Shutdown Voltage Input Low				0.4	V
V_{OS}	Output Offset Voltage			5	25	mV
$R_{OUT-GND}$	Resistor Output to GND		7.0	8.5	9.7	k Ω
P_O	Output Power (8 Ω)	THD=1%; f=1kHz		1.1		W
T_{WU}	Wake-up time			170	220	ms
T_{SD}	Thermal Shutdown Temperature		150	170		°C
THD+N	Total Harmonic Distortion + Noise	$P_O=0.4$ Wrms; f=1kHz		0.15		%
PSRR	Power Supply Rejection Ratio	Vripple=200mV sine p-p Input Terminated with 10 ohms to ground	55	65(f=217 Hz) 67(f=1kHz)		dB
T_{SDT}	Shutdown Time	8 Ω load		1.0		ms

Electrical Characteristics VDD = 3V, TA = 25°C

Symbol	Parameter	Conditions	EUA4890			Unit
			Min	Typ	Max.	
IDD	Quiescent Power Supply Current	V _{IN} =0V, I _O =0A, No load		1.8	4	mA
		V _{IN} =0V, I _O =0A, 8Ω load		1.9	4	mA
ISD	Shutdown Current	V _{SHUTDOWN} =0V		0.1	2.0	μA
VSDIH	Shutdown Voltage Input High		1.2			V
VSDIL	Shutdown Voltage Input Low				0.4	V
VOS	Output Offset Voltage			5	25	mV
ROUT-GND	Resistor Output to GND		7.0	8.5	9.7	kΩ
PO	Output Power (8Ω)	THD=1%; f=1kHz	0.28	0.35		W
TWU	Wake-up time			120	180	ms
TS	Thermal Shutdown Temperature		150	170		°C
THD+N	Total Harmonic Distortion + Noise	P _O =0.15 Wrms; f=1kHz		0.15		%
PSRR	Power Supply Rejection Ratio	V _{ripple} =200mV sine p-p Input Terminated with 10 ohms to ground	45	65(f=217 Hz) 66(f=1kHz)		dB

Electrical Characteristics VDD = 2.6V, TA = 25°C

Symbol	Parameter	Conditions	EUA4890			Unit
			Min	Typ	Max.	
IDD	Quiescent Power Supply Current	V _{IN} =0V, I _O =0A, No load		1.7		mA
ISD	Shutdown Current	V _{SHUTDOWN} =0V		0.1		μA
PO	Output Power (8Ω)	THD=1%; f=1kHz		0.25		W
	Output Power (4Ω)	THD=1%; f=1kHz		0.32		
THD+N	Total Harmonic Distortion + Noise	P _O =0.1Wrms; f=1kHz		0.15		%
PSRR	Power Supply Rejection Ratio	V _{ripple} =200mV sine p-p Input Terminated with 10 ohms to ground		55(f=217 Hz) 56(f=1kHz)		dB

Typical Operating Characteristics

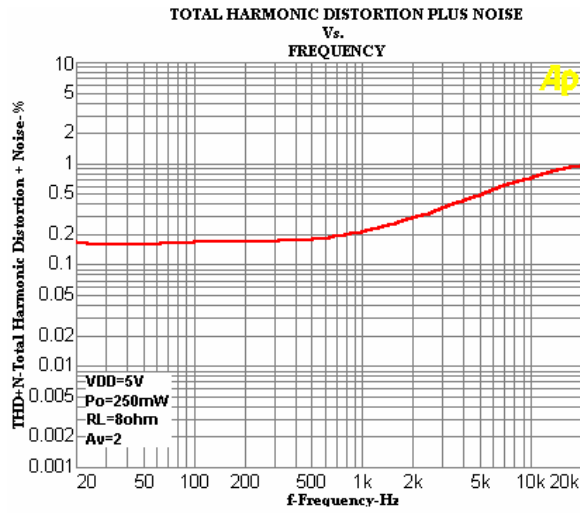

Figure3.

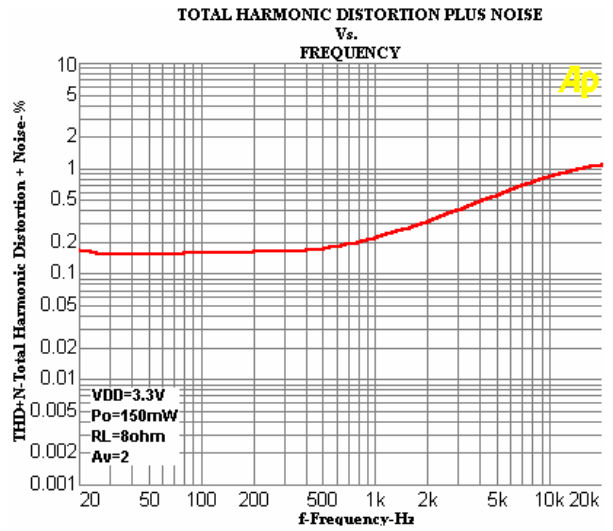

Figure4.

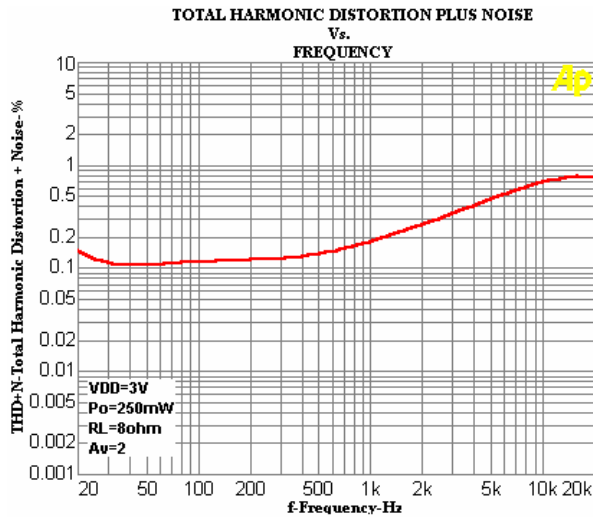

Figure5.

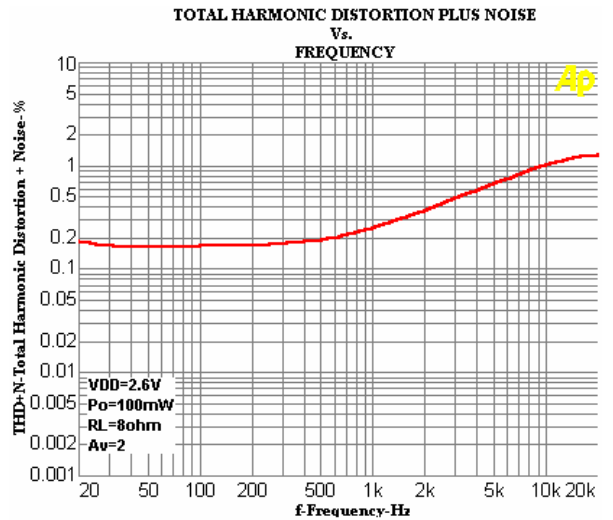

Figure6.

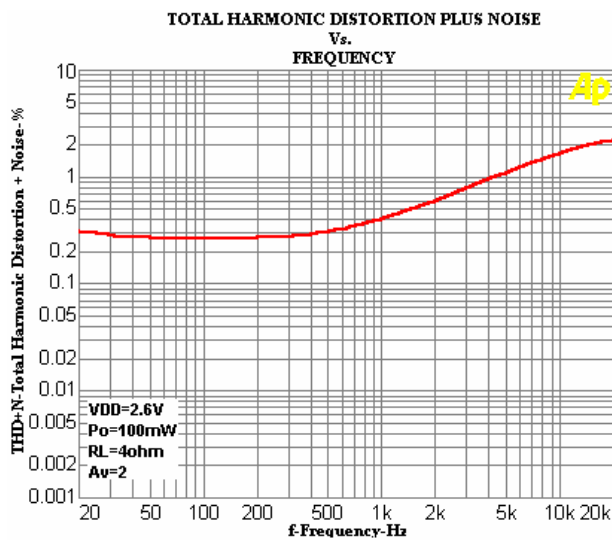

Figure7.

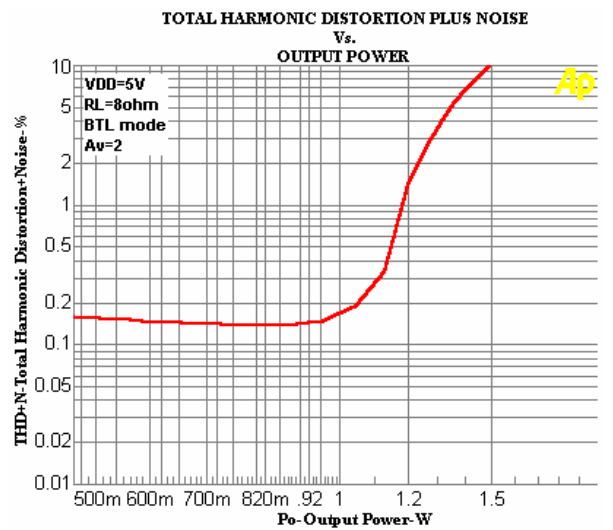

Figure8.

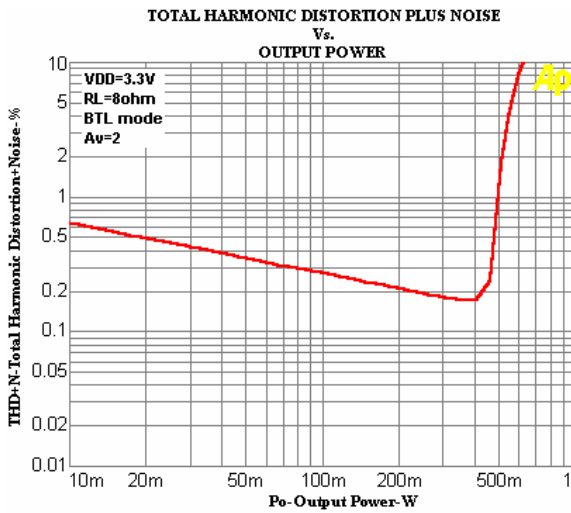

Figure9.

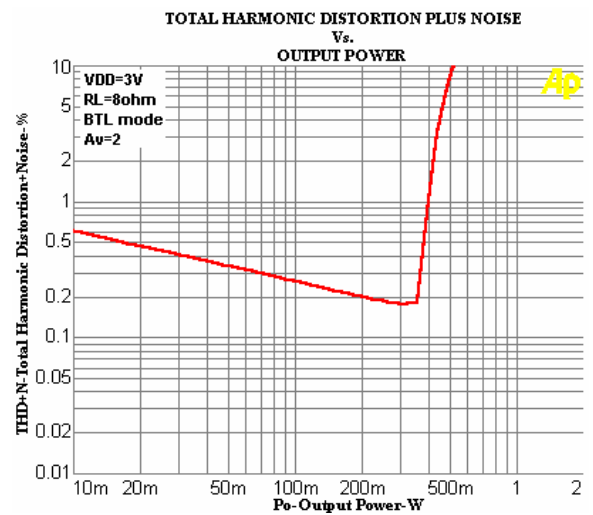

Figure10.

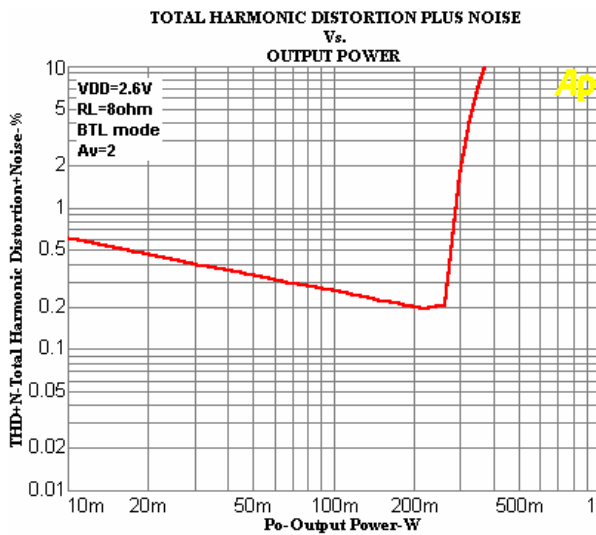

Figure11.

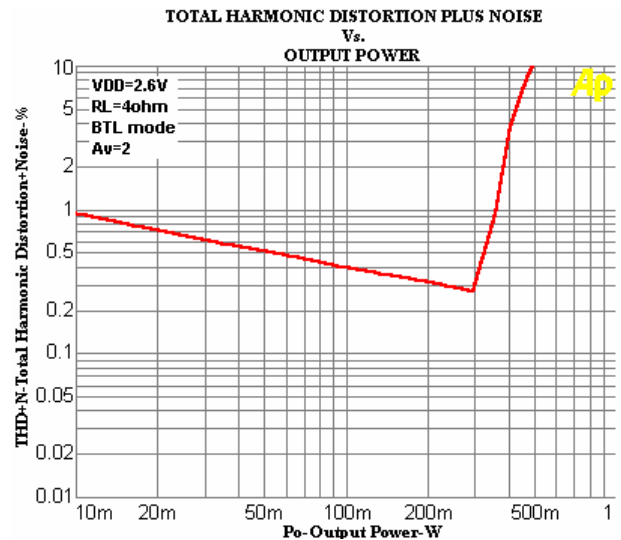

Figure12.

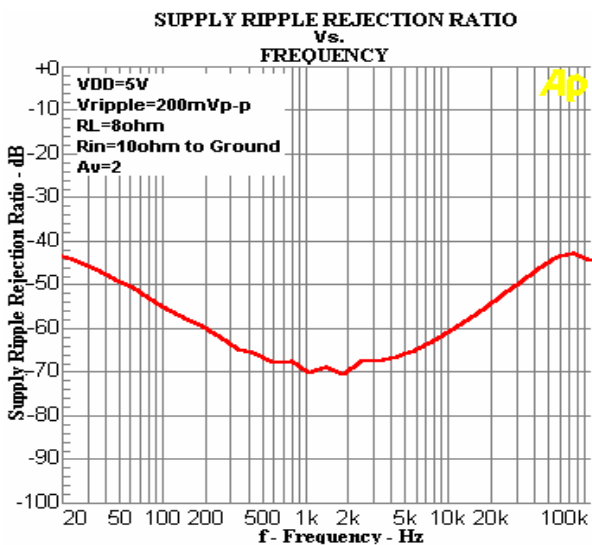

Figure13.

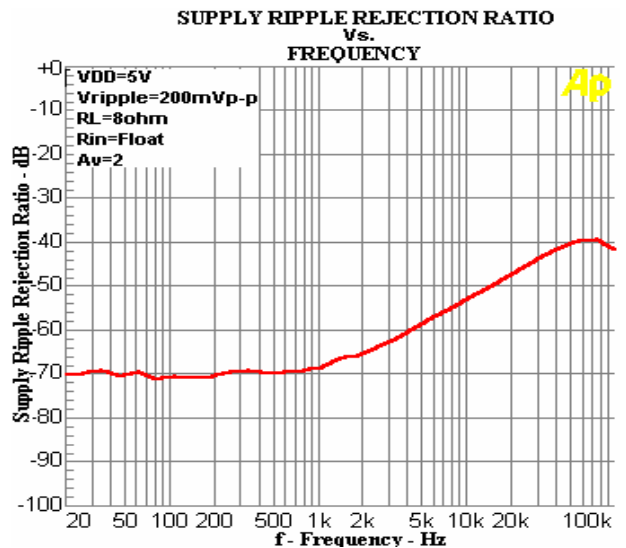

Figure14.

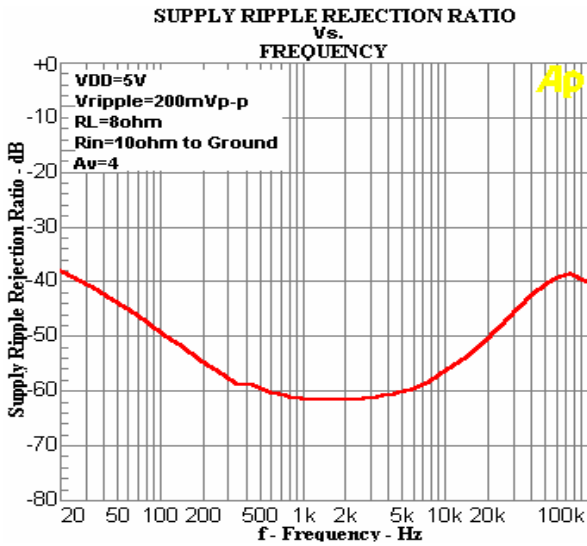

Figure15.

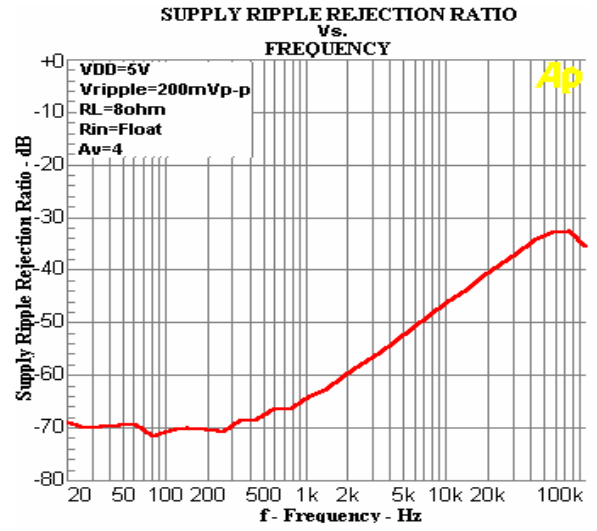

Figure16.

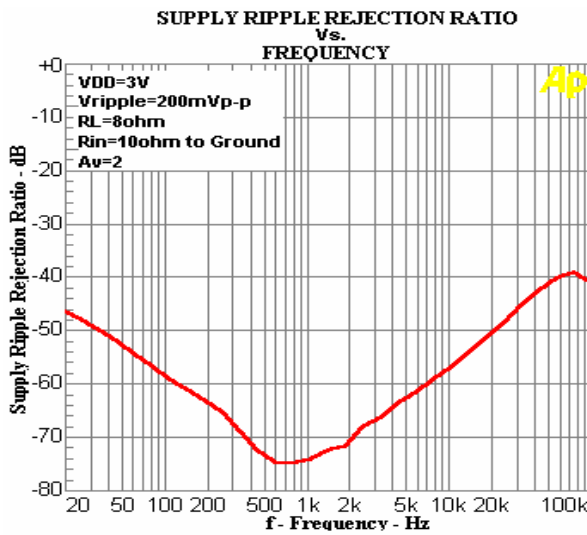

Figure17.

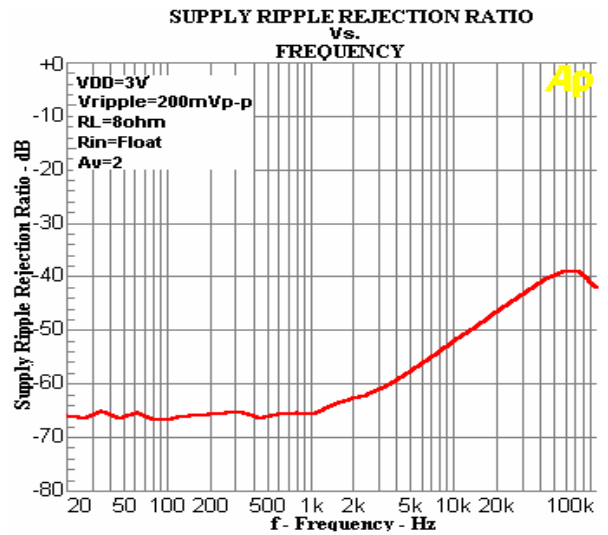

Figure18.

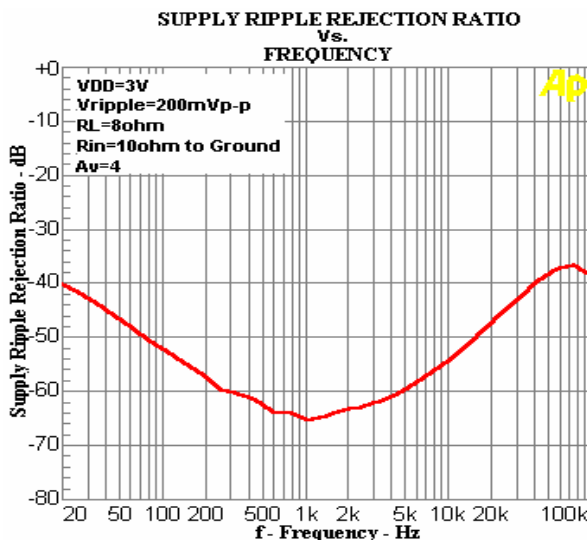

Figure19.

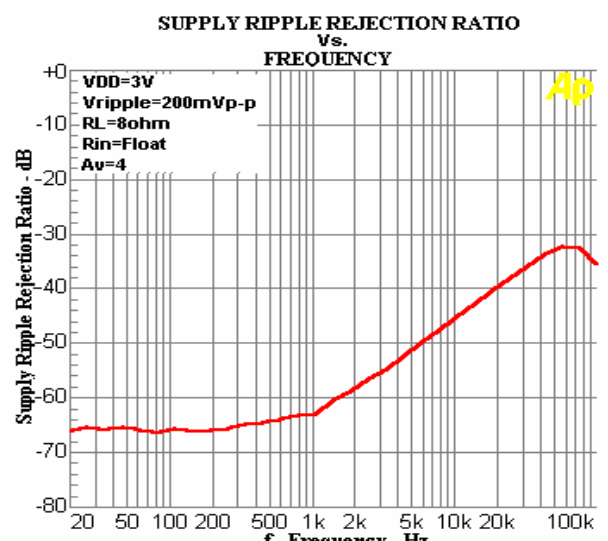

Figure20.

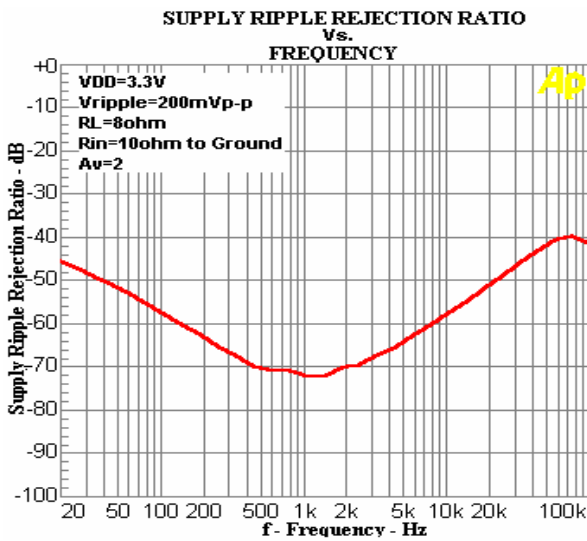

Figure21.

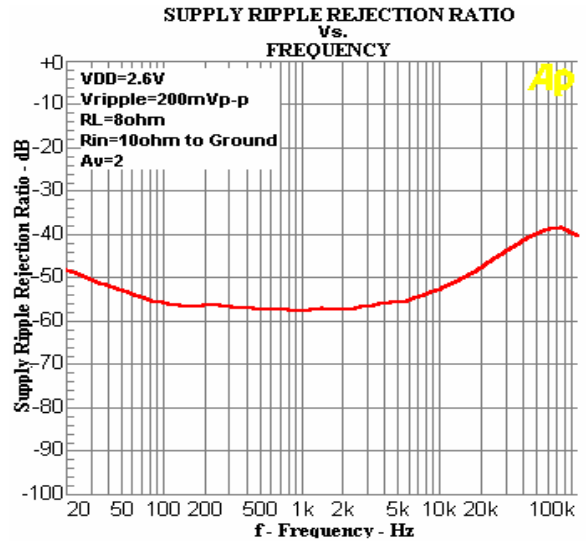

Figure22.

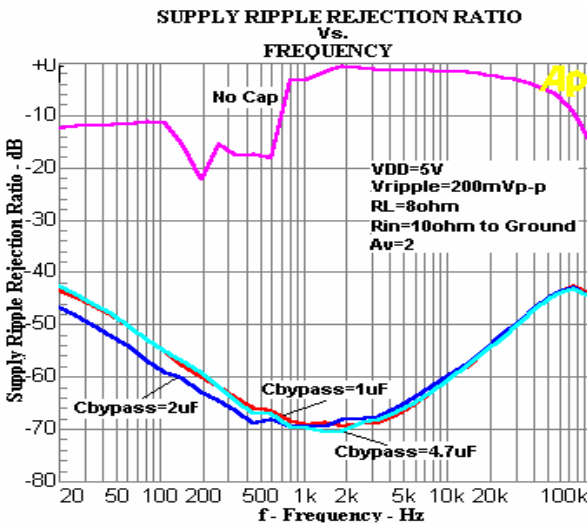

Figure23.

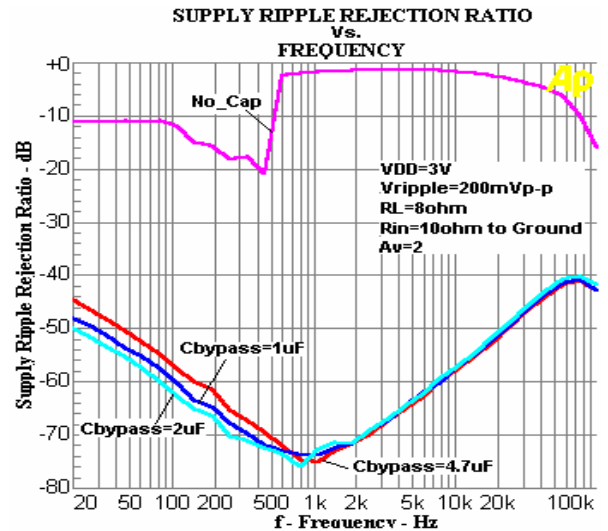

Figure24.

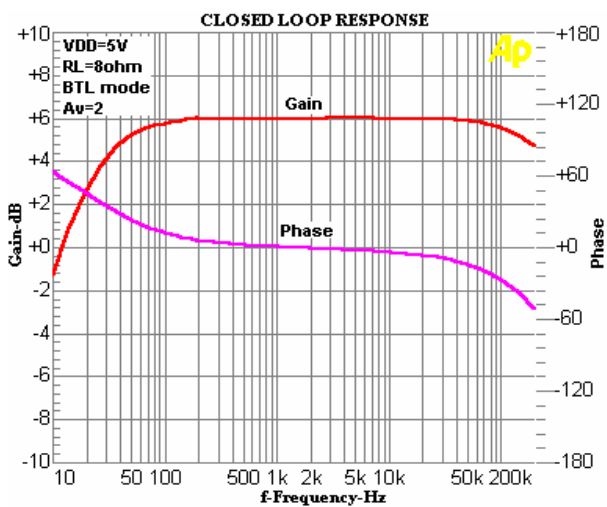

Figure25.

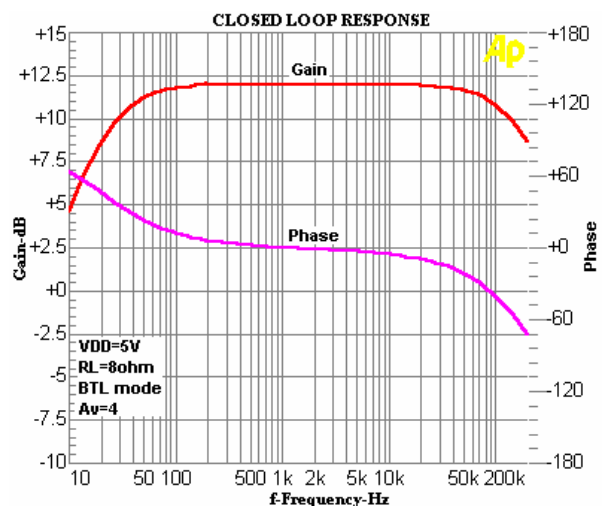

Figure26.

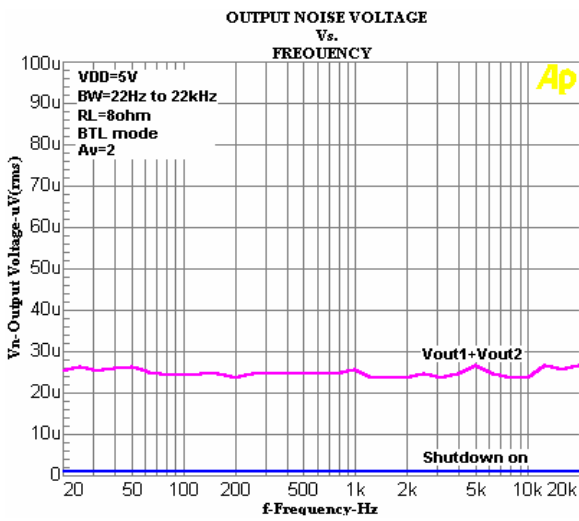

Figure27.

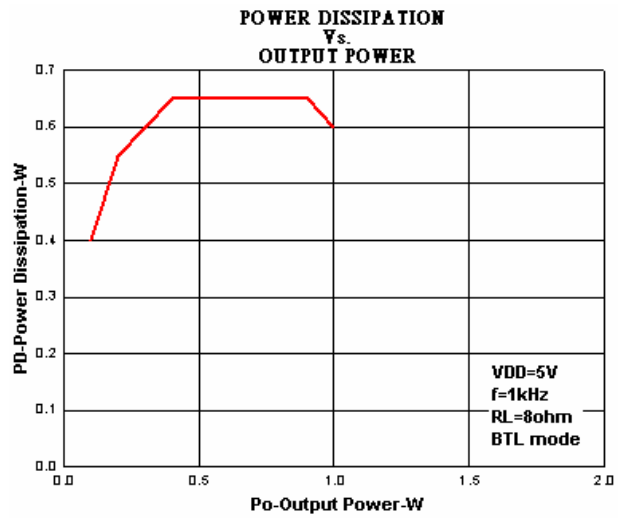

Figure28.

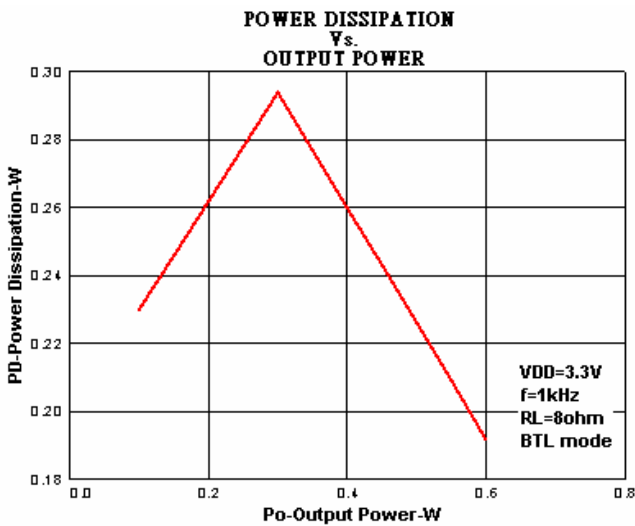

Figure29.

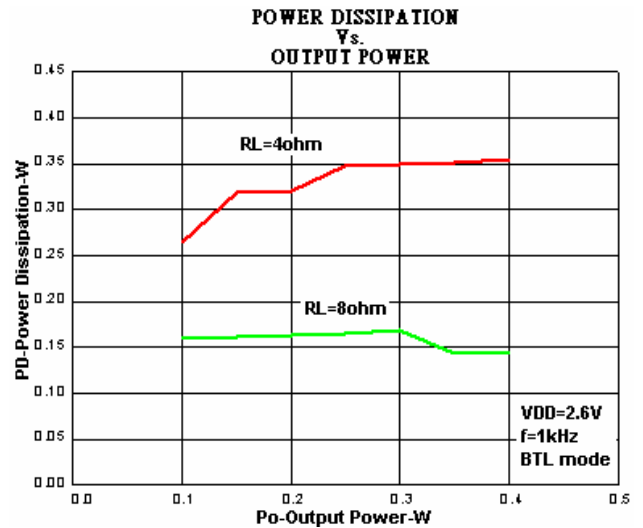

Figure30.

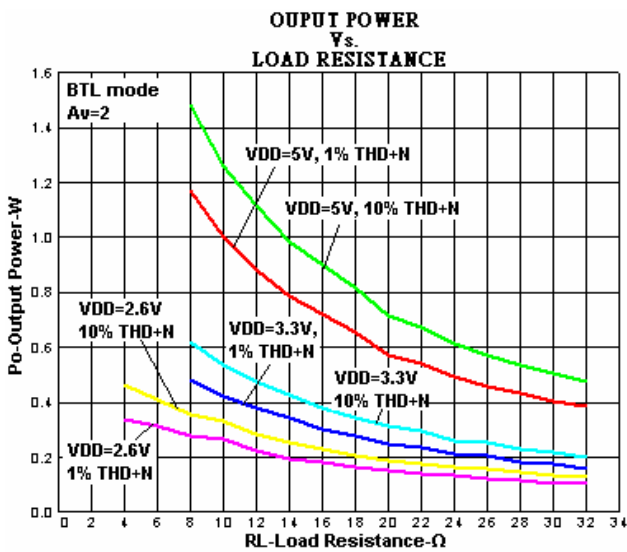

Figure31.

Application Information

Bridged Configuration Explanation

The structure of the EUA4890 is basically composed of two identical internal power amplifiers; the first one is externally configurable with gain-setting resistors R_{in} and R_f (the closed-loop gain is fixed by the ratios of these resistors) and the second is internally fixed in an inverting unity-gain configuration by two resistors of 20kΩ. So the load is driven differentially through OUTA and OUTB outputs. This configuration eliminates the need for an output coupling capacitor.

The differential-ended amplifier presents two major advantages:

- The possible output power is four times larger (the output swing is doubled) as compared to single-ended amplifier under the same conditions.
- Output pins (OUTA and OUTB) are biased at the same potential $V_{DD}/2$, this eliminates the need for an output coupling capacitor required with a single-ended amplifier configuration.

The differential closed loop-gain of the amplifier is

$$\text{given by } A_{vd} = 2 \times \frac{R_f}{R_{in}} = \frac{V_{orms}}{V_{inrms}}$$

Power Dissipation

Power dissipation is a major concern when designing a successful amplifier, whether the amplifier is bridged or single-ended. A direct consequence of the increased power delivered to the load by a bridge amplifier is an increase in internal power dissipation. Since the EUA4890 has two operational amplifiers in one package, the maximum internal power dissipation is 4 times that of a single-ended amplifier. The maximum power dissipation for a given application can be derived from the power dissipation graphs of from equation 1.

$$P_{D_{MAX}} = 4 * (V_{DD})^2 / (2\pi^2 R_L) \text{ -----(1)}$$

It is critical that the maximum junction temperature $T_{J_{MAX}}$ of 150°C is not exceeded. $T_{J_{MAX}}$ can be determine from the power derating curves by using $P_{D_{MAX}}$ and the PC board foil area. By adding additional copper foil, the thermal resistance of the application can be reduced, resulting in higher $P_{D_{MAX}}$. Additional copper foil can be added to any of the leads connected to the EUA4890. If $T_{J_{MAX}}$ still exceeds 150°C, then additional changes must be made. These changes can include reduced supply voltage, higher load impedance, or reduced ambient temperature. Internal power dissipation is a function of output power.

Proper Selection of External Components

The EUA4890 is unity-gain stable and requires no external components besides gain-setting resistors, and input coupling capacitor and proper bypassing capacitor in the typical application.

Gain-Setting Resistor Selection (R_{in} and R_f)

R_{in} and R_f set the closed-loop gain of the amplifier.

In order to optimize device and system performance, the EUA4890 should be used in low gain configurations.

The low gain configuration minimizes THD + noise values and maximizes the signal to noise ratio, and the amplifier can still be used without running into the bandwidth limitations. Low gain configurations require large input signals to obtain a given output power. Input signals equal to or greater than 1Vrms are available from sources such as audio codecs.

A closed loop gain in the range from 2 to 5 is recommended to optimize overall system performance.

An input resistor (R_{in}) value of 20kΩ is realistic in most of applications, and does not require the use of a too large capacitor C_{in} .

Input Capacitor Selection (C_{in})

The input coupling capacitor blocks the DC voltage at the amplifier input terminal. This capacitor creates a high-pass filter with R_{in} , the cut-off frequency is given by

$$f_c = \frac{1}{2 * \pi * R_{in} * C_{in}}$$

The size of the capacitor must be large enough to couple in low frequencies without severe attenuation. However a large input coupling capacitor requires more time to reach its quiescent DC voltage ($V_{DD}/2$) and can increase the turn-on pops.

An input capacitor value between 0.1μ and 0.39μF performs well in many applications (with $R_{in}=22k\Omega$).

Bypass Capacitor Selection (C_{by})

The bypass capacitor C_{by} provides half-supply filtering and determines how fast the EUA4890 turns on.

This capacitor is critical component to minimize the turn-on pop. A 1.0μF bypass capacitor value ($C_{in} < 0.39\mu F$) should produce clickless and popless shutdown transitions. The amplifier is still functional with a 0.1μF capacitor value but is more susceptible to pop and click noise. Thus, a 1.0μF bypassing capacitor is recommended.

Power Supply Bypassing (C_s)

As with any amplifier, proper supply bypassing is critical for low noise performance and high power supply rejection. The capacitor location on both the bypass and power supply pins should be as close to the device is possible.

Packaging Information

MSOP-8

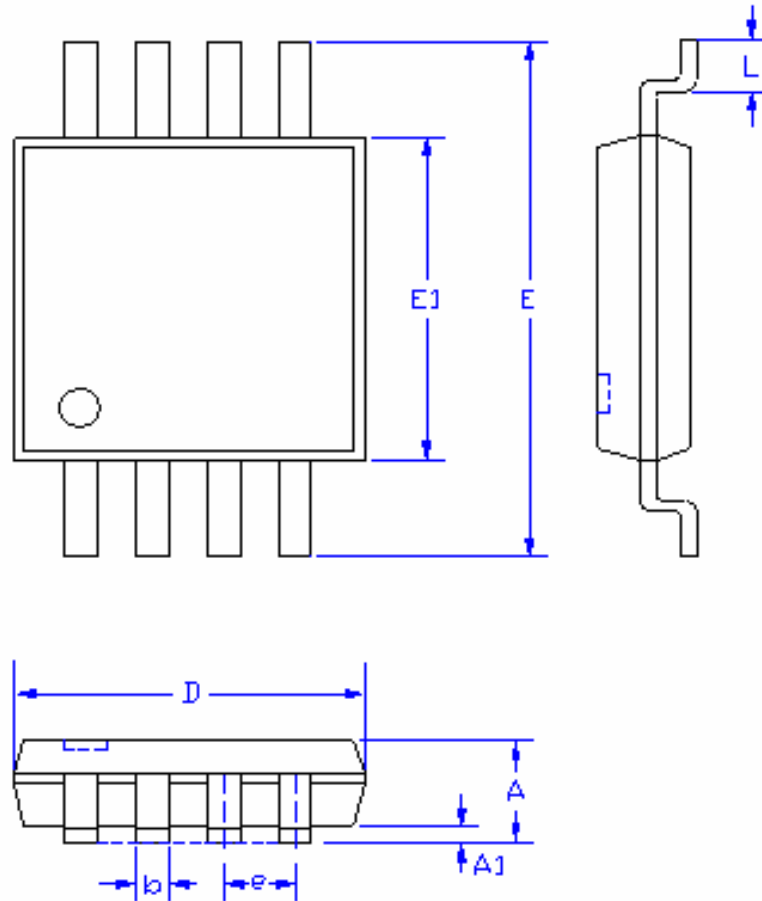

SYMBOLS	MILLIMETERS		INCHES	
	MIN.	MAX.	MIN.	MAX.
A	-	1.10	-	0.043
A1	0.00	0.15	0.000	0.006
D	3.00		0.118	
E1	3.00		0.118	
E	4.70	5.10	0.185	0.201
L	0.40	0.80	0.016	0.031
b	0.22	0.38	0.008	0.015
e	0.65		0.026	

DFN-8

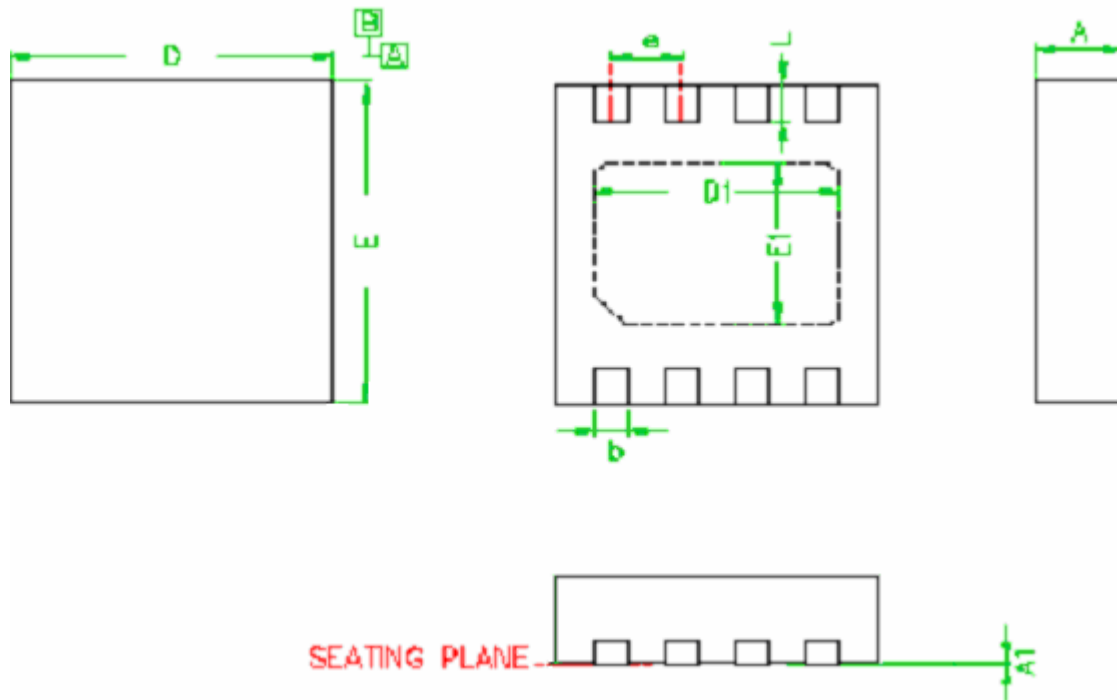

SYMBOLS	MILLIMETERS		INCHES	
	MIN.	MAX.	MIN.	MAX.
A	0.70	0.90	0.028	0.035
A1	0.00	0.05	0.000	0.002
b	0.20	0.40	0.008	0.016
D	2.85	3.15	0.112	0.124
D1	2.30		0.090	
E	2.85	3.15	0.112	0.124
E1	1.50		0.059	
e	0.65		0.026	
L	0.25	0.45	0.010	0.018