

Data sheet | Item number: 2002-1303

3-conductor through terminal block; 2.5 mm²; suitable for Ex e II applications; side and center marking; for DIN-rail 35 x 15 and 35 x 7.5; Push-in CAGE CLAMP®; 2,50 mm²; red

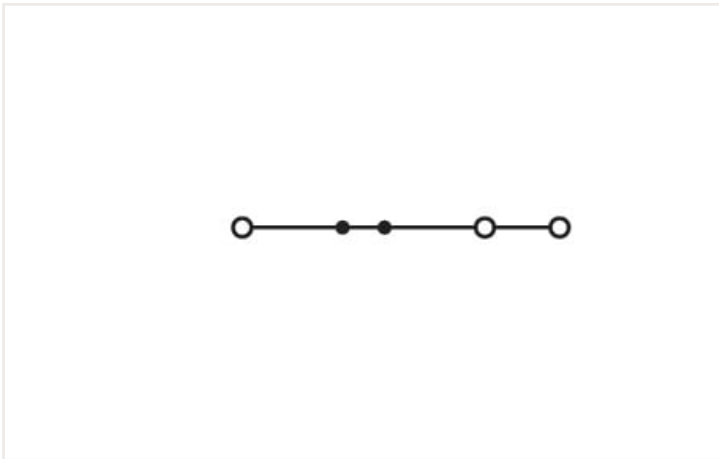

<https://www.wago.com/2002-1303>

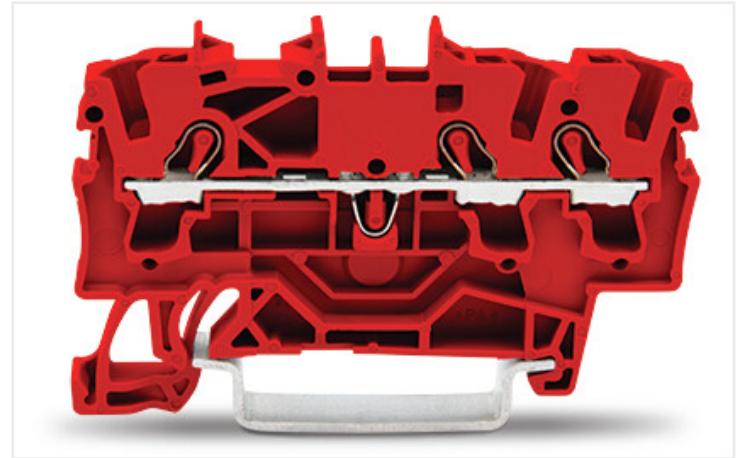
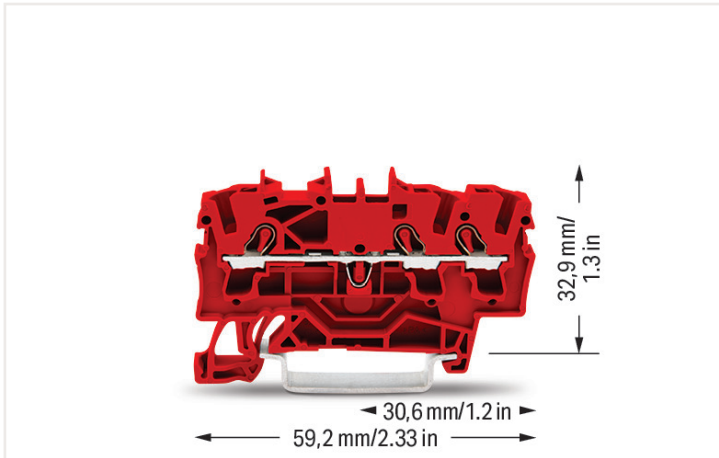

Electrical data

Ratings per IEC/EN

| | |
|-------------------------------|--|
| Ratings per | IEC/EN 60947-7-1 |
| Nominal voltage (III/3) | 800 V |
| Rated impulse voltage (III/3) | 8 kV |
| Rated current | 24 A |
| Rated current 2 | 32 A |
| Legend (ratings) | (III / 3) Δ Overvoltage category III / Pollution degree 3 |

Ratings per UL

| | |
|--------------------------------|---------|
| Approvals per | UL 1059 |
| Rated voltage UL (Use Group B) | 600 V |
| Rated current UL (Use Group B) | 20 A |
| Rated voltage UL (Use Group C) | 600 V |
| Rated current UL (Use Group C) | 20 A |

Ratings per CSA

| | |
|---------------------------------|-----------------|
| Approvals per | CSA 22.2 No 158 |
| Rated voltage CSA (Use Group B) | 600 V |
| Rated current CSA (Use Group B) | 20 A |
| Rated voltage CSA (Use Group C) | 600 V |
| Rated current CSA (Use Group C) | 20 A |

Ex information

| | |
|-------------------------------------|---|
| Reference hazardous areas | See installation notes in section "Knowledge" and Downloads – Documentation – Additional Information: Technical Section; Technical explanations |
| Ratings per | ATEX: PTB 03 ATEX 1162 U / IECEx: PTB 03.0004U (Ex eb IIC Gb) |
| Rated voltage EN (Ex e II) | 550 V |
| Rated current (Ex e II) | 22 A |
| Rated current (Ex e II) with jumper | 20 A |

Power loss

| | |
|--|------------------|
| Power loss, per pole (potential) | 0.7661 W |
| Rated current I_N for specified power loss | 24 A |
| Resistance value for specified, current-dependent power loss | 0.00133 Ω |

Connection data

| | |
|-----------------------------------|---|
| Total number of connection points | 2 |
| Total number of potentials | 1 |
| Number of levels | 1 |
| Number of jumper slots | 2 |

Connection 1

| | |
|--|---|
| Connection technology | Push-in CAGE CLAMP® |
| Actuation type | Operating tool |
| Connectable conductor materials | Copper |
| Nominal cross-section | 2.5 mm ² |
| Solid conductor | 0.25 ... 4 mm ² / 22 ... 12 AWG |
| Solid conductor; push-in termination | 0.75 ... 4 mm ² / 18 ... 12 AWG |
| Fine-stranded conductor | 0.25 ... 4 mm ² / 22 ... 12 AWG |
| Fine-stranded conductor; with insulated ferrule | 0.25 ... 2.5 mm ² / 22 ... 14 AWG |
| Fine-stranded conductor; with ferrule; push-in termination | 1 ... 2.5 mm ² / 18 ... 14 AWG |
| Note (conductor cross-section) | Depending on the conductor characteristic, a conductor with a smaller cross-section can also be inserted via push-in termination. |
| Strip length | 10 ... 12 mm / 0.39 ... 0.47 inches |
| Wiring direction | Front-entry wiring |

Physical data

| | |
|-----------------------------------|------------------------|
| Width | 5.2 mm / 0.205 inches |
| Height | 59.2 mm / 2.33 inches |
| Depth from upper-edge of DIN-rail | 32.9 mm / 1.295 inches |

Mechanical data

| | |
|---------------|---------------------|
| Mounting type | DIN-35 rail |
| Marking level | Center/side marking |

Material data

| | |
|-----------------------------|--|
| Note (material data) | Information on material data can be found here |
| Color | red |
| Material group | I |
| Insulation material | Polyamide (PA66) |
| Flammability class per UL94 | V0 |
| Fire load | 0.125 MJ |
| Weight | 6.2 g |

Environmental requirements

| | |
|----------------------------------|-----------------|
| Processing temperature | -35 ... +85 °C |
| Continuous operating temperature | -60 ... +105 °C |

Commercial data

| | |
|-------------------------------------|---------------|
| Product Group | 22 (TOPJOB S) |
| eCl@ss 10.0 | 27-14-11-20 |
| eCl@ss 9.0 | 27-14-11-20 |
| ETIM 8.0 | EC000897 |
| ETIM 7.0 | EC000897 |
| PU (SPU) | 100 Stück |
| Packaging type | Box |
| Country of origin VKOrg Germany | DE |
| GTIN | 4044918081498 |
| Customs tariff number VKOrg Germany | 85369010000 |

Approvals and certificates

Ex-Approvals



| Approval | Standard | Certificate name |
|--|----------------|---|
| AEx Underwriters Laboratories Inc. | UL 60079 | E185892 (AEx eb IIC resp. Ex eb IIC) |
| ATEX Physikalisch Technische Bundesanstalt (PTB) | EN 60079 | PTB 03 ATEX 1162 U (II2G Ex eb IIC Gb, IM2 Ex eb IMb) |
| CCCEX CQST/CNEx | CNCA-C23-01 | 2020312313000238 |
| EAC Brjansker Zertifizierungs- stelle | TP TC 012/2011 | RU C-DE.AM02. B.00127/19 (Ex e IIC Gb U) |
| IECEX Physikalisch Technische Bundesanstalt | IEC 60079 | IECEX PTB 03.0004U (Ex eb IIC Gb or Ex eb I Mb) |

Country specific Approvals



| Approval | Standard | Certificate name |
|---------------------------------|---------------|------------------|
| CCA DEKRA Certification B.V. | EN 60947 | 71-120369 |
| CCA DEKRA Certification B.V. | EN 60947 | NTR NL 7892 |
| CCA DEKRA Certification B.V. | C22.2 No. 158 | 1536069 |

Ship Approvals



| Approval | Standard | Certificate name |
|---|----------|------------------|
| ABS American Bureau of Ship- ping | EN 60947 | 20-HG1941090-PDA |
| BV Bureau Veritas S.A. | EN 60947 | 38586/B0 BV |
| DNV GL Det Norske Veritas, Ger- manischer Lloyd | - | TAE00001V2 |
| LR Lloyds Register | EN 60947 | 91/20112 (E9) |

UL-Approvals



| Approval | Standard | Certificate name |
|---|----------|------------------|
| UL Underwriters Laboratories Inc. | UL 1059 | E45172 |

Downloads

Environmental Product Compliance

| | |
|--|-------------------|
| Compliance Search | |
| Environmental Product Compliance 2002-1303 | ↓ |

Documentation

| | | |
|-------------------------------|-------------------|-------------------|
| Additional Information | | |
| Technical Section | pdf 2142.18 KB | ↓ |

| | | | |
|-----------------|------------|------------------|-------------------|
| Bid Text | | | |
| 2002-1303 | 29.04.2019 | xml 4.14 KB | ↓ |
| 2002-1303 | 23.04.2019 | docx 15.00 KB | ↓ |

CAD/CAE-Data

| | |
|---------------------------|-------------------|
| CAD data | |
| 2D/3D Models 2002-1303 | ↓ |

| | |
|--------------------------------|-------------------|
| CAE data | |
| EPLAN Data Portal 2002-1303 | ↓ |
| WSCAD Universe 2002-1303 | ↓ |
| ZUKEN Portal 2002-1303 | ↓ |

1 Compatible products

1.1 Required accessories

1.1.1 End plate

1.1.1.1 End plate



Item no.: 2002-1391
End and intermediate plate; 0.8 mm thick; gray

Item no.: 2002-1392
End and intermediate plate; 0.8 mm thick; orange

1.2 Optional accessories

1.2.1 DIN-rail

1.2.1.1 Mounting accessories



Item no.: 210-196
Aluminum carrier rail; 35 x 8.2 mm; 1.6 mm thick; 2 m long; unslotted; similar to EN 60715; silver-colored

Item no.: 210-198
Copper carrier rail; 35 x 15 mm; 2.3 mm thick; 2 m long; unslotted; according to EN 60715; copper-colored

Item no.: 210-508
Steel carrier rail; 35 x 15 mm; 1.5 mm thick; 2 m long; slotted; galvanized; similar to EN 60715; silver-colored

Item no.: 210-197
Steel carrier rail; 35 x 15 mm; 1.5 mm thick; 2 m long; slotted; similar to EN 60715; silver-colored

1.2.1.1 Mounting accessories



Item no.: 210-506

Steel carrier rail; 35 x 15 mm; 1.5 mm thick; 2 m long; unslotted; galvanized; similar to EN 60715; silver-colored



Item no.: 210-114

Steel carrier rail; 35 x 15 mm; 1.5 mm thick; 2 m long; unslotted; similar to EN 60715; silver-colored



Item no.: 210-118

Steel carrier rail; 35 x 15 mm; 2.3 mm thick; 2 m long; unslotted; according to EN 60715; silver-colored



Item no.: 210-115

Steel carrier rail; 35 x 7.5 mm; 1 mm thick; 2 m long; slotted; according to EN 60715; Hole width 18 mm; silver-colored

1.2.2 End plate

1.2.2.1 End plate



Item no.: 209-191

Separator for Ex e/Ex i applications; 3 mm thick; 120 mm wide; orange



Item no.: 2002-1393

Separator plate; 2 mm thick; oversized; gray



Item no.: 2002-1394

Separator plate; 2 mm thick; oversized; orange

1.2.3 Ferrule

1.2.3.1 Ferrule



Item no.: 216-241

Ferrule; Sleeve for 0.5 mm² / 20 AWG; insulated; electro-tin plated; electrolytic copper; gastight crimped; acc. to DIN 46228, Part 4/09.90; white



Item no.: 216-242

Ferrule; Sleeve for 0.75 mm² / 18 AWG; insulated; electro-tin plated; electrolytic copper; gastight crimped; acc. to DIN 46228, Part 4/09.90; gray



Item no.: 216-262

Ferrule; Sleeve for 0.75 mm² / 18 AWG; insulated; electro-tin plated; electrolytic copper; gastight crimped; acc. to DIN 46228, Part 4/09.90; gray



Item no.: 216-243

Ferrule; Sleeve for 1 mm² / AWG 18; insulated; electro-tin plated; electrolytic copper; gastight crimped; acc. to DIN 46228, Part 4/09.90; red



Item no.: 216-263

Ferrule; Sleeve for 1 mm² / AWG 18; insulated; electro-tin plated; electrolytic copper; gastight crimped; acc. to DIN 46228, Part 4/09.90; red



Item no.: 216-244

Ferrule; Sleeve for 1.5 mm² / AWG 16; insulated; electro-tin plated; electrolytic copper; gastight crimped; acc. to DIN 46228, Part 4/09.90; black



Item no.: 216-264

Ferrule; Sleeve for 1.5 mm² / AWG 16; insulated; electro-tin plated; electrolytic copper; gastight crimped; acc. to DIN 46228, Part 4/09.90; black



Item no.: 216-246

Ferrule; Sleeve for 2.5 mm² / AWG 14; insulated; electro-tin plated; electrolytic copper; gastight crimped; acc. to DIN 46228, Part 4/09.90; blue



Item no.: 216-266

Ferrule; Sleeve for 2.5 mm² / AWG 14; insulated; electro-tin plated; electrolytic copper; gastight crimped; acc. to DIN 46228, Part 4/09.90; blue

1.2.4 Installation

1.2.4.1 Mounting accessories



Item no.: 709-169

Cover carrier; Type 3; gray



Item no.: 709-156

Cover; Type 3; suitable for cover carrier, type 3; 1 m long; transparent

1.2.5 Insulation stop

1.2.5.1 Insulation stop



Item no.: 2002-171
Insulation stop; 0.25 - 0.5 mm²; 5 pieces/
strip; light gray

Item no.: 2002-172
Insulation stop; 0.75 - 1 mm²; 5 pieces/
strip; dark gray

1.2.6 Jumper

1.2.6.1 Jumper



Item no.: 2002-400
Continuous jumper; 2-way; insulated; light
gray

Item no.: 2002-423/000-006
Continuous jumper; from 1 to 3; insulated;
blue

Item no.: 2002-423
Continuous jumper; from 1 to 3; insulated;
light gray

Item no.: 2002-423/000-005
Continuous jumper; from 1 to 3; insulated;
red



Item no.: 2002-406/020-000
Delta jumper; insulated; light gray

Item no.: 2002-410/000-006
Jumper; 10-way; insulated; blue

Item no.: 2002-410
Jumper; 10-way; insulated; light gray

Item no.: 2002-410/000-005
Jumper; 10-way; insulated; red



Item no.: 2002-402/000-006
Jumper; 2-way; insulated; blue

Item no.: 2002-402
Jumper; 2-way; insulated; light gray

Item no.: 2002-402/000-005
Jumper; 2-way; insulated; red

Item no.: 2002-403/000-006
Jumper; 3-way; insulated; blue



Item no.: 2002-403
Jumper; 3-way; insulated; light gray

Item no.: 2002-403/000-005
Jumper; 3-way; insulated; red

Item no.: 2002-404/000-006
Jumper; 4-way; insulated; blue

Item no.: 2002-404
Jumper; 4-way; insulated; light gray



Item no.: 2002-404/000-005
Jumper; 4-way; insulated; red

Item no.: 2002-405/000-006
Jumper; 5-way; insulated; blue

Item no.: 2002-405
Jumper; 5-way; insulated; light gray

Item no.: 2002-405/000-005
Jumper; 5-way; insulated; red



Item no.: 2002-406/000-006
Jumper; 6-way; insulated; blue

Item no.: 2002-406
Jumper; 6-way; insulated; light gray

Item no.: 2002-406/000-005
Jumper; 6-way; insulated; red

Item no.: 2002-407/000-006
Jumper; 7-way; insulated; blue



Item no.: 2002-407
Jumper; 7-way; insulated; light gray

Item no.: 2002-407/000-005
Jumper; 7-way; insulated; red

Item no.: 2002-408/000-006
Jumper; 8-way; insulated; blue

Item no.: 2002-408
Jumper; 8-way; insulated; light gray



Item no.: 2002-408/000-005
Jumper; 8-way; insulated; red

Item no.: 2002-409/000-006
Jumper; 9-way; insulated; blue

Item no.: 2002-409
Jumper; 9-way; insulated; light gray

Item no.: 2002-409/000-005
Jumper; 9-way; insulated; red



Item no.: 2002-440
Jumper; from 1 to 10; insulated; light gray

Item no.: 2002-433
Jumper; from 1 to 3; insulated; light gray

Item no.: 2002-434
Jumper; from 1 to 4; insulated; light gray

Item no.: 2002-435
Jumper; from 1 to 5; insulated; light gray



Item no.: 2002-436
Jumper; from 1 to 6; insulated; light gray

Item no.: 2002-437
Jumper; from 1 to 7; insulated; light gray

Item no.: 2002-438
Jumper; from 1 to 8; insulated; light gray

Item no.: 2002-439
Jumper; from 1 to 9; insulated; light gray



Item no.: 2002-480
Staggered jumper; 10-way; insulated; light
gray

Item no.: 2002-481
Staggered jumper; 11-way; insulated;
light gray

Item no.: 2002-482
Staggered jumper; 12-way; insulated;
light gray

Item no.: 2002-473/011-000
Staggered jumper; 2-way; from 1 to 3; in-
sulated; light gray



Item no.: 2002-472
Staggered jumper; 2-way; insulated; light
gray

Item no.: 2002-473
Staggered jumper; 3-way; insulated; light
gray

Item no.: 2002-475/011-000
Staggered jumper; 3-way; insulated; light
gray

Item no.: 2002-474
Staggered jumper; 4-way; insulated; light
gray

1.2.6.1 Jumper



Item no.: 2002-475
Staggered jumper; 5-way; insulated; light gray



Item no.: 2002-476
Staggered jumper; 6-way; insulated; light gray



Item no.: 2002-477
Staggered jumper; 7-way; insulated; light gray



Item no.: 2002-478
Staggered jumper; 8-way; insulated; light gray



Item no.: 2002-479
Staggered jumper; 9-way; insulated; light gray



Item no.: 2002-477/011-000
Staggered jumper; insulated; light gray



Item no.: 2002-479/011-000
Staggered jumper; insulated; light gray



Item no.: 2002-481/011-000
Staggered jumper; insulated; light gray



Item no.: 2002-405/011-000
Star point jumper; 3-way; insulated; light gray



Item no.: 2006-499
Step-down jumper; from 2006/2004 to 2004/2002/2001 series; insulated; light gray



Item no.: 2016-499
Step-down jumper; from 2016/2010 to 2010/2006/2004/2002 series; insulated; light gray



Item no.: 210-103
Wire comming chain; insulated; black



Item no.: 210-123
Wire comming chain; insulated; blue

1.2.7 Marking

1.2.7.1 Group marker carrier



Item no.: 2009-191
Group marker carrier; gray



Item no.: 2009-192
Group marker carrier; gray



Item no.: 2009-193
Group marker carrier; gray

1.2.7.2 Marker



Item no.: 2009-145/000-006
Mini-WSB Inline; for Smart Printer; 1700 pieces on roll; stretchable 5 - 5.2 mm; plain; snap-on type; blue



Item no.: 2009-145/000-007
Mini-WSB Inline; for Smart Printer; 1700 pieces on roll; stretchable 5 - 5.2 mm; plain; snap-on type; gray



Item no.: 2009-145/000-023
Mini-WSB Inline; for Smart Printer; 1700 pieces on roll; stretchable 5 - 5.2 mm; plain; snap-on type; green



Item no.: 2009-145/000-012
Mini-WSB Inline; for Smart Printer; 1700 pieces on roll; stretchable 5 - 5.2 mm; plain; snap-on type; orange



Item no.: 2009-145/000-005
Mini-WSB Inline; for Smart Printer; 1700 pieces on roll; stretchable 5 - 5.2 mm; plain; snap-on type; red



Item no.: 2009-145/000-024
Mini-WSB Inline; for Smart Printer; 1700 pieces on roll; stretchable 5 - 5.2 mm; plain; snap-on type; violet



Item no.: 2009-145
Mini-WSB Inline; for Smart Printer; 1700 pieces on roll; stretchable 5 - 5.2 mm; plain; snap-on type; white



Item no.: 2009-145/000-002
Mini-WSB Inline; for Smart Printer; 1700 pieces on roll; stretchable 5 - 5.2 mm; plain; snap-on type; yellow



Item no.: 248-501/000-006
Mini-WSB marking card; as card; not stretchable; plain; snap-on type; blue



Item no.: 248-501/000-007
Mini-WSB marking card; as card; not stretchable; plain; snap-on type; gray



Item no.: 248-501/000-023
Mini-WSB marking card; as card; not stretchable; plain; snap-on type; green



Item no.: 248-501/000-017
Mini-WSB marking card; as card; not stretchable; plain; snap-on type; light green



Item no.: 248-501/000-012
Mini-WSB marking card; as card; not stretchable; plain; snap-on type; orange



Item no.: 248-501/000-005
Mini-WSB marking card; as card; not stretchable; plain; snap-on type; red



Item no.: 248-501/000-024
Mini-WSB marking card; as card; not stretchable; plain; snap-on type; violet



Item no.: 248-501
Mini-WSB marking card; as card; not stretchable; plain; snap-on type; white



Item no.: 248-501/000-002
Mini-WSB marking card; as card; not stretchable; plain; snap-on type; yellow



Item no.: 793-5501/000-006
WMB marking card; as card; for terminal block width 5 - 17.5 mm; stretchable 5 - 5.2 mm; plain; snap-on type; blue



Item no.: 793-5501/000-014
WMB marking card; as card; for terminal block width 5 - 17.5 mm; stretchable 5 - 5.2 mm; plain; snap-on type; brown



Item no.: 793-5501/000-007
WMB marking card; as card; for terminal block width 5 - 17.5 mm; stretchable 5 - 5.2 mm; plain; snap-on type; gray



Item no.: 793-5501/000-023
WMB marking card; as card; for terminal block width 5 - 17.5 mm; stretchable 5 - 5.2 mm; plain; snap-on type; green



Item no.: 793-5501/000-017
WMB marking card; as card; for terminal block width 5 - 17.5 mm; stretchable 5 - 5.2 mm; plain; snap-on type; light green



Item no.: 793-5501/000-012
WMB marking card; as card; for terminal block width 5 - 17.5 mm; stretchable 5 - 5.2 mm; plain; snap-on type; orange



Item no.: 793-5501/000-005
WMB marking card; as card; for terminal block width 5 - 17.5 mm; stretchable 5 - 5.2 mm; plain; snap-on type; red

1.2.7.2 Marker



Item no.: 793-5501/000-024

WMB marking card; as card; for terminal block width 5 - 17.5 mm; stretchable 5 - 5.2 mm; plain; snap-on type; violet

Item no.: 793-5501

WMB marking card; as card; for terminal block width 5 - 17.5 mm; stretchable 5 - 5.2 mm; plain; snap-on type; white

Item no.: 793-5501/000-002

WMB marking card; as card; for terminal block width 5 - 17.5 mm; stretchable 5 - 5.2 mm; plain; snap-on type; yellow

Item no.: 793-501/000-006

WMB marking card; as card; not stretchable; plain; snap-on type; blue



Item no.: 793-501/000-007

WMB marking card; as card; not stretchable; plain; snap-on type; gray

Item no.: 793-501/000-023

WMB marking card; as card; not stretchable; plain; snap-on type; green

Item no.: 793-501/000-017

WMB marking card; as card; not stretchable; plain; snap-on type; light green

Item no.: 793-501/000-012

WMB marking card; as card; not stretchable; plain; snap-on type; orange



Item no.: 793-501/000-005

WMB marking card; as card; not stretchable; plain; snap-on type; red

Item no.: 793-501/000-024

WMB marking card; as card; not stretchable; plain; snap-on type; violet

Item no.: 793-501

WMB marking card; as card; not stretchable; plain; snap-on type; white

Item no.: 793-501/000-002

WMB marking card; as card; not stretchable; plain; snap-on type; yellow



Item no.: 2009-115/000-006

WMB-Inline; for Smart Printer; 1500 pieces on roll; stretchable 5 - 5.2 mm; plain; snap-on type; blue

Item no.: 2009-115/000-007

WMB-Inline; for Smart Printer; 1500 pieces on roll; stretchable 5 - 5.2 mm; plain; snap-on type; gray

Item no.: 2009-115/000-023

WMB-Inline; for Smart Printer; 1500 pieces on roll; stretchable 5 - 5.2 mm; plain; snap-on type; green

Item no.: 2009-115/000-017

WMB-Inline; for Smart Printer; 1500 pieces on roll; stretchable 5 - 5.2 mm; plain; snap-on type; light green



Item no.: 2009-115/000-012

WMB-Inline; for Smart Printer; 1500 pieces on roll; stretchable 5 - 5.2 mm; plain; snap-on type; orange

Item no.: 2009-115/000-005

WMB-Inline; for Smart Printer; 1500 pieces on roll; stretchable 5 - 5.2 mm; plain; snap-on type; red

Item no.: 2009-115/000-024

WMB-Inline; for Smart Printer; 1500 pieces on roll; stretchable 5 - 5.2 mm; plain; snap-on type; violet

Item no.: 2009-115

WMB-Inline; for Smart Printer; 1500 pieces on roll; stretchable 5 - 5.2 mm; plain; snap-on type; white



Item no.: 2009-115/000-002

WMB-Inline; for Smart Printer; 1500 pieces on roll; stretchable 5 - 5.2 mm; plain; snap-on type; yellow

1.2.7.3 Marker carrier



Item no.: 2002-161

Adaptor; gray

Item no.: 2009-198

Adaptor; gray

1.2.7.4 Marking strip



Item no.: 2009-110

Marking strips; for Smart Printer; on reel; not stretchable; plain; snap-on type; white

1.2.8 Plug

1.2.8.1 Diode plug



Item no.: 2002-880/1000-411

Component plug; 2-pole; with diode 1N4007; 10.4 mm wide; Operating temperature 85°C max.; gray

1.2.8.2 Empty component plug housing



Item no.: [2002-880](#)

Empty component plug housing; 10.4 mm wide; 2-pole; Type 4; gray

1.2.8.3 LED plug



Item no.: [2002-880/1000-541](#)

Component plug; 2-pole; LED (red); 10.4 mm wide; Operating temperature 85°C max.; gray



Item no.: [2002-880/1000-836](#)

Component plug; 2-pole; LED (red); 10.4 mm wide; Operating temperature 85°C max.; gray



Item no.: [2002-880/1000-542](#)

Component plug; 2-pole; LED (red); 10.4 mm wide; Operating temperature 85°C max.; multicoloured

1.2.9 Protective warning marker

1.2.9.1 Cover



Item no.: [2002-115](#)

Protective warning marker; for 5 terminal blocks; with high-voltage symbol, black; yellow

1.2.10 Push-in type wire jumper

1.2.10.1 Jumper



Item no.: [2009-414](#)

Push-in type wire jumper; 1.5 mm²; insulated; 110 mm long; black



Item no.: [2009-414/000-005](#)

Push-in type wire jumper; 1.5 mm²; insulated; 110 mm long; black



Item no.: [2009-416](#)

Push-in type wire jumper; 1.5 mm²; insulated; 250 mm long; black



Item no.: [2009-414/000-006](#)

Push-in type wire jumper; insulated; 110 mm long; black



Item no.: [2009-412](#)

Push-in type wire jumper; insulated; 60 mm long; black

1.2.11 Test and measurement

1.2.11.1 Testing accessories



Item no.: [2002-560](#)

Modular TOPJOB®S connector; modular; for jumper contact slot; 10-pole; 2,50 mm²; gray



Item no.: [2002-511](#)

Modular TOPJOB®S connector; modular; for jumper contact slot; 1-pole; 2,50 mm²; gray



Item no.: [2002-552](#)

Modular TOPJOB®S connector; modular; for jumper contact slot; 2-pole; 2,50 mm²; gray



Item no.: [2002-553](#)

Modular TOPJOB®S connector; modular; for jumper contact slot; 3-pole; 2,50 mm²; gray



Item no.: [2002-554](#)

Modular TOPJOB®S connector; modular; for jumper contact slot; 4-pole; 2,50 mm²; gray



Item no.: [2002-555](#)

Modular TOPJOB®S connector; modular; for jumper contact slot; 5-pole; 2,50 mm²; gray



Item no.: [2002-556](#)

Modular TOPJOB®S connector; modular; for jumper contact slot; 6-pole; 2,50 mm²; gray



Item no.: [2002-557](#)

Modular TOPJOB®S connector; modular; for jumper contact slot; 7-pole; 2,50 mm²; gray



Item no.: [2002-558](#)

Modular TOPJOB®S connector; modular; for jumper contact slot; 8-pole; 2,50 mm²; gray



Item no.: [2002-559](#)

Modular TOPJOB®S connector; modular; for jumper contact slot; 9-pole; 2,50 mm²; gray



Item no.: [2002-549](#)

Spacer module; modular; e.g., for bridging commoned terminal blocks; gray



Item no.: [2009-174](#)

Test plug adapter; for 4 mm Ø test plugs; for testing TOPJOB®S rail-mounted terminal blocks; gray

1.2.11.1 Testing accessories



Item no.: 2009-182

Testing tap; for max. 2.5 mm²; tool-free connection for individual test wires 0.08 - 2.5 mm; gray

Item no.: 2002-649

TOPJOB®S L-type spacer module; modular; e.g., for bridging commoned terminal blocks; gray

Item no.: 2002-611

TOPJOB®S L-type test plug module; modular; 1-pole; 2,50 mm²; gray

1.2.12 Tool

1.2.12.1 Operating tool



Item no.: 210-658

Operating tool; Blade: 3.5 x 0.5 mm; with a partially insulated shaft; angled; short; multicoloured



Item no.: 210-720

Operating tool; Blade: 3.5 x 0.5 mm; with a partially insulated shaft; multicoloured

Installation notes

Conductor termination



All conductor types at a glance

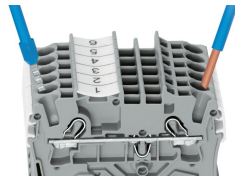

Push-in termination of solid and ferruled conductors

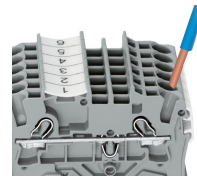

Inserting a conductor via push-in termination:
Solid conductors with cross-sections from either one size above, or up to two sizes below, the rated cross-section can be simply pushed in – no tools needed.

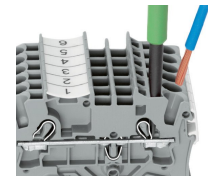

Inserting a conductor via operating tool:
Connecting fine-stranded conductors without ferrules, or small cross-sectional conductors that cannot be pushed in, is performed similarly to the original CAGE CLAMP® – just use an operating tool.
Advantage:
To open the clamp, the operating tool is inserted vertically. The conductor entry is less than 15 degrees for easier wiring.

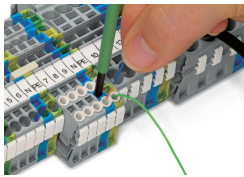

Conductor termination – insulation stop

Commoning

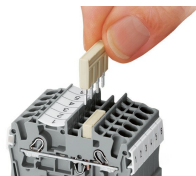

Insert push-in type jumper bar and push down until it hits backstop.

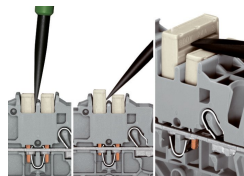

Removing a push-in type jumper bar:
Insert the operating tool between the jumper and partition wall of the dual jumper slots, then lift up the jumper.
Place the operating tool in the center of jumpers for up to five contacts (see above), or alternately on both sides for jumpers with more than five contacts.

Commoning

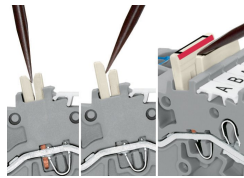
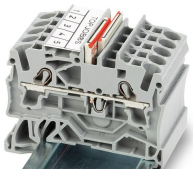

Orient the staggered jumpers' red stripes on the inside. Insert the staggered jumper and push down until it hits the backstop.

Removing a staggered jumper: Insert the operating tool between the staggered jumpers, then lift up the jumper.

Commoning

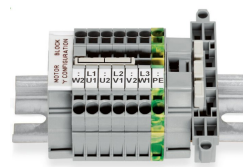
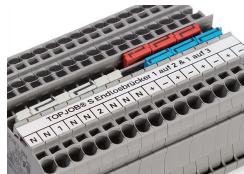

Continuous jumpers (2002 Series) readily connect an endless number of terminal blocks to each other via single jumper slot. Use the second jumper slot for additional commoning or testing.

The 1-to-3 adjacent jumper for continuous commoning enables every other terminal block to be commoned. For example, positive and negative potentials can be accommodated alongside each other.

This star point jumper has been specially developed to create a "star point" and is used on motor terminal boards equipped with Rail-Mount Terminal Blocks TOP-JOB® S.

This delta jumper has been specially developed to create a delta configuration and is used on motor terminal boards equipped with rail-mount terminal blocks TOPJOB® S.

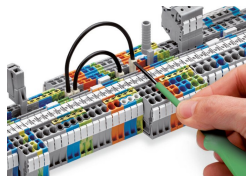

Push down the wire jumper until fully inserted. Lift the jumper with an operating tool for rewiring.

Commoning

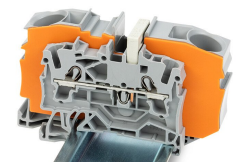
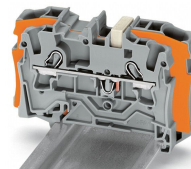
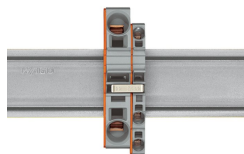
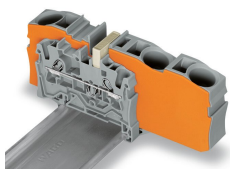

Step-down jumpers common terminal blocks of different sizes, without losing a conductor clamping point. This can be beneficial on long conductor runs where voltage drop can be a problem. A large conductor can be easily connected to smaller conductors at the distribution point. Commoning may be made in either direction using the special thin end plate to cover the open side. Additional through terminal blocks having a smaller cross-section may be commoned using push-in type jumper bars.

Using step-down jumpers, an end plate must be inserted between the terminal blocks to be commoned.

Step-down jumper (2006-499) commons 6/4 mm² (10/12 AWG) terminal blocks (2006/2004 Series) with 4/2.5/1.5 mm² (AWG 12/14/16) terminal blocks (2004/2002/2001 Series).

Step-down jumper (2016-499) commons 16/10 mm² (16/8 AWG) terminal blocks (2016/2010 Series) with 10/6/4/2.5 mm² (8/10/12/14 AWG) terminal blocks (2010/2006/2004/2002 Series).

Commoning

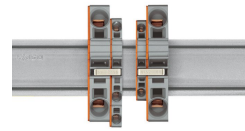
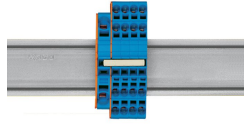
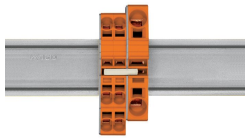

Stepping down via push-in type jumper bar:
Commoning via open terminal side with end plate allows jumpering over two cross-section sizes for 16 mm² (6 AWG) and 10 mm² (8 AWG) and one cross-section size for 6/4/2.5 mm² (10/12/14 AWG). An example: from 16 mm² (6 AWG) to 6 mm² (10 AWG) (see illustration above) or from 10 mm² (8 AWG) to 4 mm² (12 AWG).

Stepping down via push-in type jumper bar:
Commoning via closed terminal side with end plate allows jumpering over two cross-section sizes, e.g., from 16 mm² (6 AWG) to 6 mm² (10 AWG) or from 6 mm² (10 AWG) to 2.5 mm² (14 AWG) (see illustration above).

Note:
The total current of the outgoing circuits must not exceed the nominal current of the step-down jumper/push-in type jumper bar.

Testing

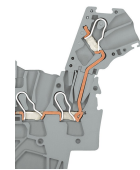
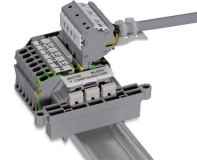
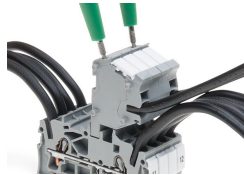

The modular TOPJOB® S connectors also connect conductors of the same size as the terminal blocks being used.

TOPJOB® S Connectors with a 2 mm Ø test socket for testing voltage via 2-pole voltage tester

Rail-mount terminal block assembly for electric motor wiring

L-type test plug module – cross-sectional view of contacts



Test plug adapter (2009-174, CAT I) for 4 mm Ø plugs – compatible with 2000 to 2016 Series

Testing tap (2009-182) for tool-free connection of test cables up to 2.5 mm² (12 AWG) – compatible with 2000 to 2016 Series

Marking

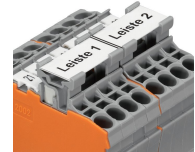
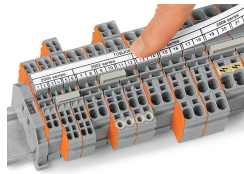
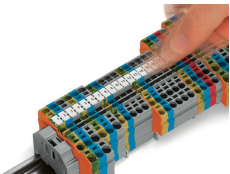

Snapping WMB Inline markers into marker slots.

TOPJOB® S 2009-193 Group Marker Carrier (equipped with a marking strip) for all 2001 to 2016 Series TOPJOB® S Rail-Mount Terminal Blocks
Do not use on an end plate!

Using marker carriers for marking strips (2002-161) in jumper slots.

Ex application

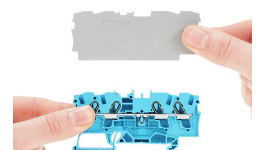
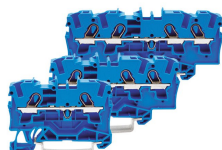
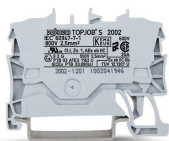

Through terminal blocks with a blue insulated housing are suitable for Ex i applications.

All through and ground conductor terminal blocks are suitable for Ex e II applications.

Separator plate for Ex e/Ex i applications
An end plate must be applied to the terminal block located directly behind an Ex e/Ex i separator plate.

Ex application

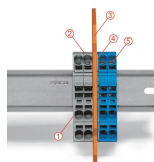
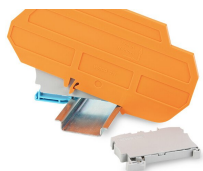

Ex e II/Ex i terminal strip

Note:

The movable feet of terminal blocks and separator plates must face the same direction.

A separator plate is located between the Ex e II and Ex i terminal strip.

End plate

Ex e II terminal blocks

Separator plate for Ex e/Ex i applications

End plate

Ex i terminal blocks

According to EN 50020, a minimum distance of 50 mm must be kept between live parts of Ex e and Ex i circuits. The use of Ex e/Ex i separators is a space-saving solution when Ex e and Ex i terminal blocks are mounted on a common DIN-rail.