

Material :

- (a) Housing : PA66(UL94V-0)
- (b) Terminal : Brass , Tin Plated
- (c) Screws : Steel , Ni Plated

Electrical :

- | | | |
|------------------------------|----------------|--------------------|
| | UL | IEC |
| 1.Rated Voltage : | 300V | 250V |
| 2.Rated Current : | 15A | 24A |
| 3.Torque Value : | M3 , 4.43Lb.in | M3 , 0.5N.m |
| 4.Wire Range : | 22-14AWG | 2.5mm ² |
| 5.Stripping Length : | 7-8mm | |
| 6.Withstanding Voltage : | AC1600V/1Min. | |
| 7.Operating Temperature : | -40°C~+105°C | |
| 8.RoHS Compliance | | |
| 9.Safty Approval : | cULus | |
| 10.Undimensioned Tolerances: | | |

Pitch Range In mm			Nominal Dimension Range In mm						— / — / —	
≤6	6 ~ 10	10 ~ 24	≤30	30 ~ 60	60 ~ 100	100 ~ 150	>150	0.05/10	∠	
±0.10	±0.15	±0.25	±0.20	±0.30	±0.50	±0.70	±1.00	±0.1°		

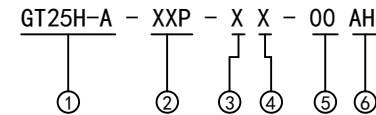
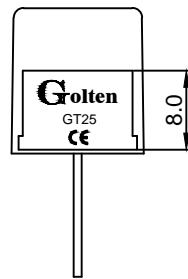
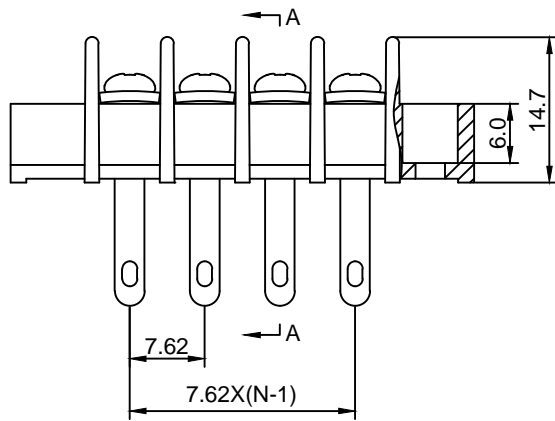
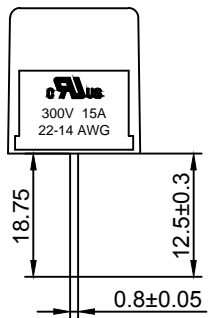

- ① Series No.
- ② Poles
02 02Contacts
03 03Contacts
...
24 24Contacts
- ③ 1 Single Pitch
2 Double Pitch
- ④ Color: 1 Grey
2 Blue
3 Black(Standard For AH)
4 Green
5 Orange
6 Red
7 Transparent
8 Yellow
9 White
- ⑤ Customer Request : 00--Standard
- ⑥ AH--Standard(PA66)

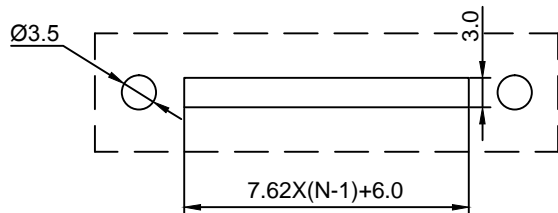
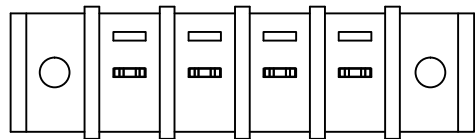
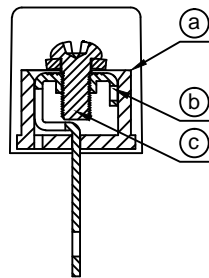

DETACHED LISTS	Grolten 宁波冠泰电子有限公司 NINGBO GOLTEN ELECTRONICS CO., LTD.							
	APPD: MA_7/16/16'	PART NO. GT25H-A-XXP-XX-00AH						
	CHKD: Yu_7/15/16'							
	DRFT: Chen_7/14/16'							
 THIRD ANGLE PROJECTION		<table border="1"> <tr> <td>REV</td> <td>1</td> </tr> <tr> <td>SHEET</td> <td>1/1</td> </tr> <tr> <td>SCALE</td> <td>1/1</td> </tr> </table>	REV	1	SHEET	1/1	SCALE	1/1
REV	1							
SHEET	1/1							
SCALE	1/1							
 DO NOT SCALE DRAWING								