

M公制螺纹/Metric Thread

序号 No.	产品名称 Part code	产品料号 Part NO.	螺纹规格AG Thread size	扳手尺寸SW Wrench size	卡口范围PC Clamping range	螺纹外径AG Thread diameter	螺纹长度GL Thread length	重量/Weight g
1	WNA-M12(D3-6.5)	1021070111001	M12*1.5	14	3-6.5	12	5.8	13
2	WNA-M14(D3-6.5)	1021070121001	M14*1.5	14	3-6.5	14	5.8	11.8
3	WNA-M16(D4-8)	1021070131001	M16*1.5	17	4-8	16	6.7	24
4	WNA-M16(D5-10)	1021070131002	M16*1.5	20	5-10	16	6	22
5	WNA-M18(D5-10)	1021070141001	M18*1.5	20	5-10	18	7	20.7
6	WNA-M20(D6-12)	1021070151001	M20*1.5	22	6-12	20	7.8	26.4
7	WNA-M20(D6-14)	1021070151002	M20*1.5	24	8-14	20	7.8	29.6
8	WNA-M22(D6-14)	1021070161001	M22*1.5	24	8-14	22	7.3	29
9	WNA-M25(D9-16)	1021070181002	M25*1.5	27	9-16	25	7.7	40.4
10	WNA-M25(D13-18)	1021070181001	M25*1.5	30	13-18	25	7.5	48.2
11	WNA-M25(D15-21)	1021070181003	M25*1.5	35	15-21	25	8	73
12	WNA-M32(D15-22)	1021070191002	M32*1.5	35	15-22	32	8.5	72.3
13	WNA-M32(D18-20)	1021070191003	M32*1.5	35	18-20	32	8.5	73.8
14	WNA-M32(D18-25)	1021070191001	M32*1.5	40	18-25	32	8	95.85
15	WNA-M40(D18-25)	1021070201002	M40*1.5	45	18-25	40	12	150
16	WNA-M40(D22-32)	1021070201001	M40*1.5	50	22-32	40	12	161
17	WNA-M50(D22-32)	1021070461002	M50*1.5	57	22-32	50	12	234.7
18	WNA-M50(D31-38)	1021070461001	M50*1.5	57	31-38	50	12	210.8
19	WNA-M63(D37-44)	1021070481001	M63*1.5	65	37-44	63	12	322.4

PG制螺纹/PG Thread

序号 No.	产品名称 Part code	产品料号 Part NO.	螺纹规格AG Thread size	扳手尺寸SW Wrench size	卡口范围PC Clamping range	螺纹外径AG Thread diameter	螺纹长度GL Thread length	重量/Weight g
1	WNA-PG7(D3-6.5)	1021070011001	PG7	14	3-6.5	12.5	5.8	11
2	WNA-PG9(D4-8)	1021070021001	PG9	17	4-8	15.2	6.7	16.43
3	WNA-PG11(D5-10)	1021070031001	PG11	20	5-10	18.6	7	22.4
4	WNA-PG13.5(D6-12)	1021070041001	PG13.5	22	6-12	20.4	7.8	27
5	WNA-PG16(D8-14)	1021070051001	PG16	24	8-14	22.5	7.3	28.27
6	WNA-PG16(D13-18)	1021070051002	PG16	30	13-18	22.5	8	28
7	WNA-PG21(D13-18)	1021070061001	PG21	30	13-18	28.3	8	49.75
8	WNA-PG29(D18-25)	1021070071001	PG29	40	18-25	37	9	91.8
9	WNA-PG36(D22-32)	1021070081001	PG36	50	22-32	47	12	165
10	WNA-PG42(D31-38)	1021070091001	PG42	57	31-38	54	12	242
11	WNA-PG48(D37-44)	1021070101001	PG48	65	37-44	59.3	12	302

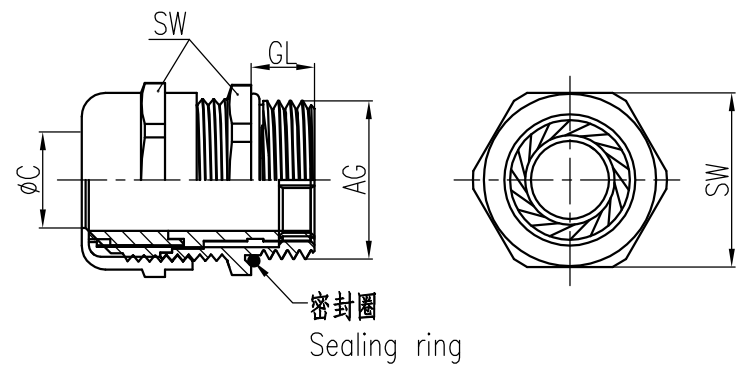
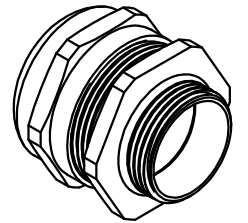

技术参数:
 - 材料:
 · 主体: 黄铜镀镍
 · 密封元件: 尼龙6和丁腈橡胶
 - 温度范围: -40℃-100℃, 短时间可以达到120℃
 - 防护等级: IP68 (在使用O型圈的情况下)

Technical specification:
 - Material:
 · Body: nickel-plated brass
 · Sealing: PA and NBR
 - Temperature range: -40℃-100℃, short-term 120℃
 - Degree of protection: IP68(with O-sealing)

						表面处理 Finish		-		图号 Drawing No.		-	
						材料 Material		-		产品代号 Part Code		WNA-XX	
标记 Mark		处数 Number		变更描述/Description		签名 Signature		日期 Date		产品料号 Part No.		-	
绘图 Drawn		姓名/Name		日期/Date		姓名/Name		日期/Date		比例 Scale		版本 REV.	
审核 Checked		BQ LUO		18.10.2010		-		-		重量 Weight		数量 Qty.	
工艺 Process		-		-		批准 Approved		YY LIN		18.10.2010		-	
										All Dimensions in mm Original Size DIN A 4		厦门唯恩电气有限公司 XIAMEN WAIN ELECTRICAL CO.LTD	