

SPRING & BUTTON CONTACTS

- Economical and reliable contacts are ideal for molded cases with self contained battery compartments
- "Solder tab" design for either wire lead or PC mounting
- Unique spring contacts adjust to variations in battery lengths
- Reliable spring contacts assure low contact resistance and a dependable connection
- Space saving, economical, excellent mechanical construction

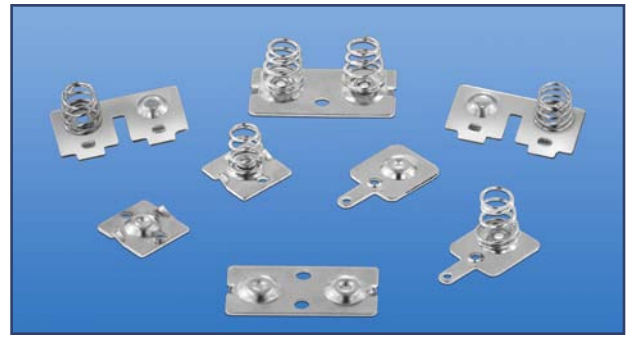

Refer to page 35 for Battery Contact Layout & Mounting Details

MATERIAL:

Plate: .020 (.51) Steel, Nickel Plate **Spring:** Spring Steel, Nickel Plate

BATTERY CONTACTS FOR MOLDED CASES

"AAA" - "AAAA" - "N" - "12V"

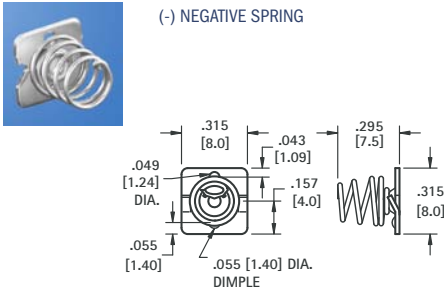

CAT. NO. 5203

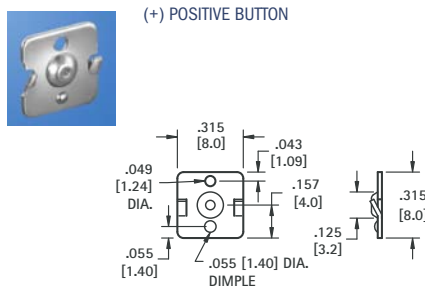

CAT. NO. 5225

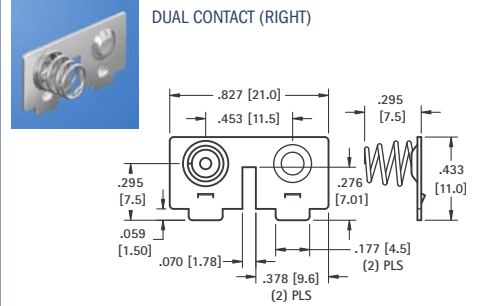

CAT. NO. 5213

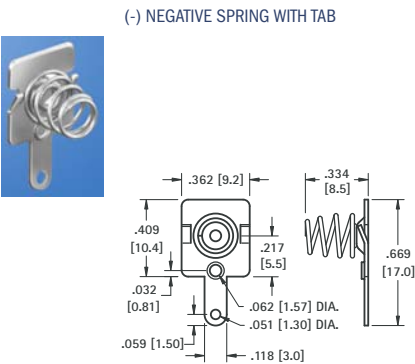

CAT. NO. 5204

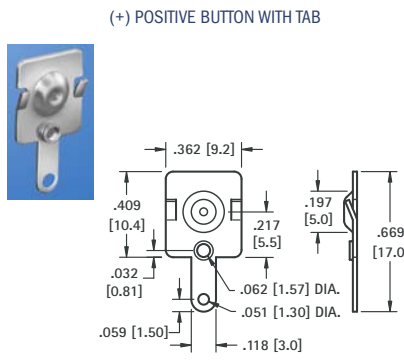

CAT. NO. 5226

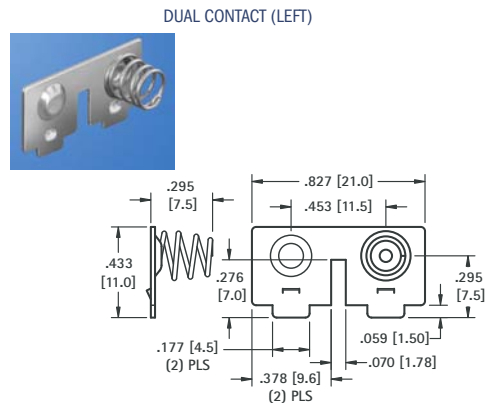

CAT. NO. 5214

"AA" - "CR2" - "A"

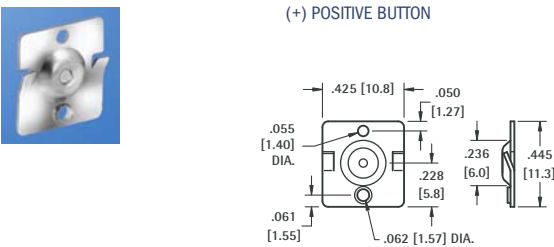

CAT. NO. 5224

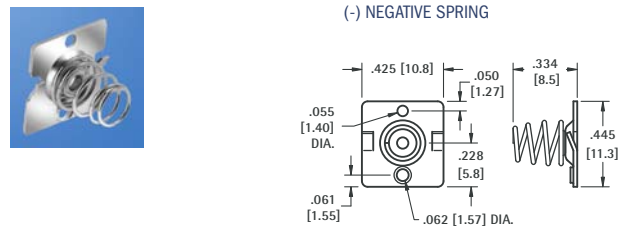

CAT. NO. 5202

"AA"

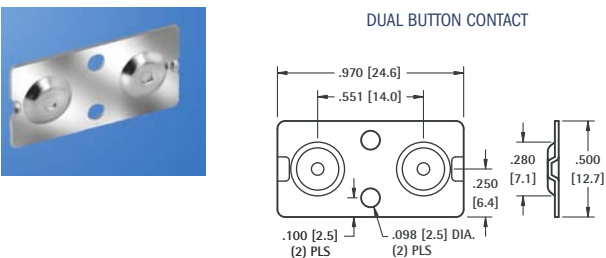

CAT. NO. 5227

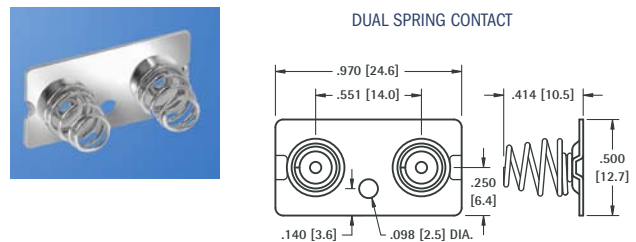

CAT. NO. 5228