

1206 Serie



Performance Specification

Model	V _{max} (Vdc)	I _{max} (A)	I _{hold} @25°C (A)	I _{trip} @25°C (A)	P _d Max. (W)	Maximum Time To Trip		Resistance	
						Current (A)	Time (Sec)	R _{i,min} (Ω)	R _{1,max} (Ω)
BpS06-050-60	60.0	100	0.05	0.15	0.4	0.3	1.50	3.600	50.000
BpS06-100-60	60.0	100	0.10	0.25	0.4	0.5	1.00	1.600	15.000
BpS06-250-16	16.0	100	0.25	0.50	0.6	8.0	0.08	0.350	2.500
BpS06-350-06	6.0	100	0.35	0.75	0.6	8.0	0.10	0.250	1.300
BpS06-500-06	6.0	100	0.50	1.00	0.6	8.0	0.10	0.150	0.700
BpS06-500-13	6.0	100	0.50	1.00	0.6	8.0	0.10	0.150	0.700
BpS06-750-06	6.0	100	0.75	1.50	0.6	8.0	0.20	0.090	0.500
BpS06A01.00-06	6.0	100	1.00	1.80	0.6	8.0	0.30	0.055	0.270
BpS06A01.50-06	6.0	100	1.50	3.00	0.8	8.0	1.00	0.040	0.130
BpS06A02.00-06	6.0	100	2.00	3.50	0.6	8.0	1.50	0.018	0.080

I_{hold} = Hold Current. Maximum current device will not trip in 25°C still air.

I_{trip} = Trip Current. Minimum current at which the device will always trip in 25°C still air.

V_{max} = Maximum operating voltage device can withstand without damage at rated current (I_{max}).

I_{max} = Maximum fault current device can withstand without damage at rated voltage (V_{max}).

P_d = Maximum power dissipation when device is in the tripped state in 25°C still air environment at rated voltage.

R_{imin/max} = Minimum/Maximum device resistance prior to tripping at 25°C.

R_{1,max} = Maximum device resistance is measured one hour post reflow.

CAUTION : Operation beyond the specified ratings may result in damage and possible arcing and flame.

Environmental Specifications

Test	Conditions	Resistance change
Passive aging	+85°C, 1000 hrs.	±5% typical
Humidity aging	+85°C, 85% R.H. , 168 hours	±5% typical
Thermal shock	+85°C to -40°C, 20 times	±33% typical
Resistance to solvent	MIL-STD-202, Method 215	No change
Vibration	MIL-STD-202, Method 201	No change
Ambient operating conditions :	- 40 °C to 85 °C	
Maximum surface temperature of the device in the tripped state is 125 °C		

AGENCY APPROVALS :



U.L approved

I_{hold} versus temperature

Model	Maximum ambient operating temperature (T _{mao}) vs. hold current (I _{hold})								
	-40°C	-20°C	0°C	25°C	40°C	50°C	60°C	70°C	85°C
BpS06-100-60	0.145	0.33	0.115	0.1	0.085	0.075	0.07	0.06	0.055
BpS06-250-16	0.37	0.33	0.29	0.25	0.22	0.20	0.17	0.15	0.12
BpS06-350-06	0.50	0.45	0.40	0.35	0.30	0.27	0.24	0.21	0.15
BpS06-500-06	0.71	0.64	0.57	0.50	0.42	0.39	0.35	0.31	0.25
BpS06-750-06	1.14	1.01	0.88	0.75	0.65	0.59	0.54	0.49	0.41
BpS06A01.00-06	1.45	1.31	1.15	1.00	0.84	0.77	0.69	0.61	0.48
BpS06A01.50-06	2.18	1.94	1.72	1.50	1.28	1.17	1.06	0.96	0.77
BpS06A02.00-06	2.88	2.63	2.34	2.00	1.74	1.58	1.42	1.17	0.93

1206 Serie

Construction and Dimension (Unit:mm)

Model	A		B		C		D	E
	Min.	Max.	Min.	Max.	Min.	Max.	Min.	Min.
BpS06-050-60	3.00	3.50	1.50	1.80	0.60	1.10	0.15	0.10
BpS06-100-60	3.00	3.50	1.50	1.80	0.60	1.10	0.15	0.10
BpS06-250-16	3.00	3.50	1.50	1.80	0.27	0.65	0.15	0.10
BpS06-350-06	3.00	3.50	1.50	1.80	0.27	0.65	0.15	0.10
BpS06-500-06	3.00	3.50	1.50	1.80	0.27	0.65	0.15	0.10
BpS06-750-06	3.00	3.50	1.50	1.80	0.27	0.65	0.15	0.10
BpS06A01.00-06	3.00	3.50	1.50	1.80	0.50	1.25	0.15	0.10
BpS06A01.50-06	3.00	3.50	1.50	1.80	0.75	1.80	0.15	0.10
BpS06A02.00-06	3.00	3.50	1.50	1.80	0.50	1.20	0.15	0.10

Dimensions & Marking

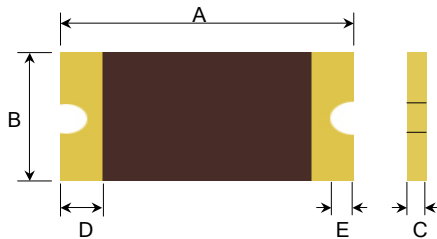

Recommended pad layout (mm)

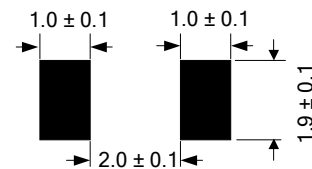

Termination pad characteristics

Terminal pad materials: Tin-Plated Nickle-Copper or Gold-Plated Nickle-Copper

Terminal pad solderability: Meets EIA specification RS186-9E and ANSI/J-STD-002 Category 3.

Rework

Use standard industry practices, the removal device must be replaced with a fresh one.

Thermal derating curve

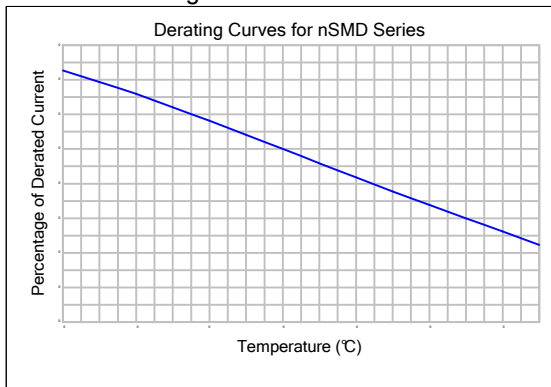

Typical time-to-trip at 25°C

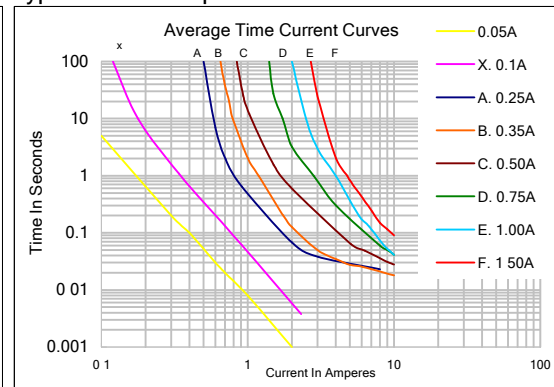

WARNING:

- Use PPTC beyond the maximum ratings or improper use may result in device damage and possible electrical arcing and flame.
- PPTC are intended for protection against occasional over current or over temperature fault conditions and should not be used when repeated fault conditions or prolonged trip events are anticipated.
- Device performance can be impacted negatively if devices are handled in a manner inconsistent with recommended electronic, thermal, and mechanical procedures for electronic components.
- Use PPTC with a large inductance in circuit will generate a circuit voltage (L di/dt) above the rated voltage of the PPTC.
- Avoid impact PPTC device its thermal expansion like placed under pressure or installed in limited space.
- Contamination of the PPTC material with certain silicon based oils or some aggressive solvents can adversely impact the performance of the devices. PPTC SMD can be cleaned by standard methods.
- Requests that customers comply with our recommended solder pad layouts and recommended reflow profile. Improper board layouts or reflow profile

1206 Serie

Recommended solder reflow conditions

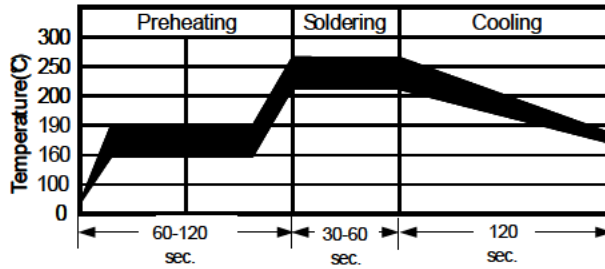

Recommended reflow methods: IR, vapor phase oven, hot air oven.

Devices are not designed to be wave soldered to the bottom side of the board.

Recommended maximum paste thickness is 0.25 mm (0.010 inch).

Devices can be cleaned using standard method and solvents. Note: If reflow temperatures exceed the recommended profile, devices may not meet the performance requirements.

Tape and reel specifications (mm)

Governing Specifications	EA481-1
W	8.15 ± 0.3
P ₀	4.0 ± 0.10
P ₁	4.0 ± 0.10
P ₂	2.0 ± 0.05
A ₀	1.95 ± 0.10
B ₀	3.45 ± 0.10
B _{1,max.}	4.35
D ₀	1.5 + 0.1, -0
F	3.5 ± 0.05
E ₁	1.75 ± 0.10
E _{2,min.}	6.25
T _{max.}	0.6
T _{1,max.}	0.1
K ₀	1.04 ± 0.1
Leader min.	390
Trailer min.	160
Reel Dimensions	
A max.	178
N min.	60
W ₁	9 ± 0.5
W ₂	12.6 ± 0.5

EIA Tape Component Dimensions

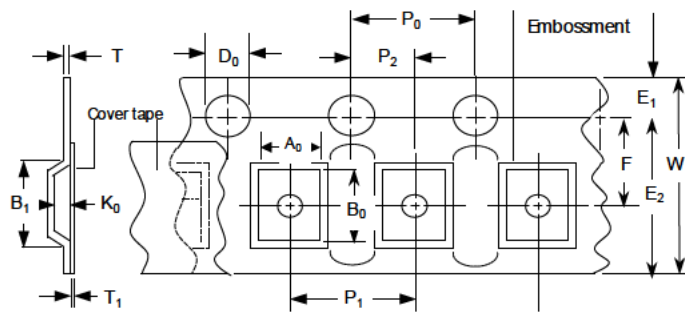

EIA Reel Dimensions

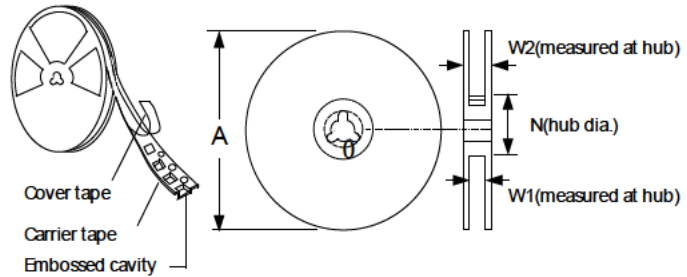

Storage and handling

Storage conditions 40°C max, 70% RH.

Devices may not meet specified performance if storage conditions are exceeded.