

PHOTOELECTRIC SWITCH

PHOTOELECTRIC SWITCH

Method of anti mutual-interference and cautions

The unstable action resulted from the entrance light from another sensor while the photoelectric sensor is approaching the equipment is called mutual interference.

- Mutual cross installation of optic projector and photoreceptor
- When using reflection type in parallel, the mutual spacing should be kept at over 1.4 times detection distance.
- When using correlation type in parallel, the mutual spacing should be kept at over 0.4 times detection distance.
- The mains voltage should be within the range of operating mains voltage.
- The following installation occasions will result in error action, take note of.
 - ① Dusty occasion
 - ② The occasion with corrosive gas
 - ③ The occasion directly spattered with water, oil and agent, etc
 - ④ Outdoor or the occasion directly shine by hard light like, sunlight

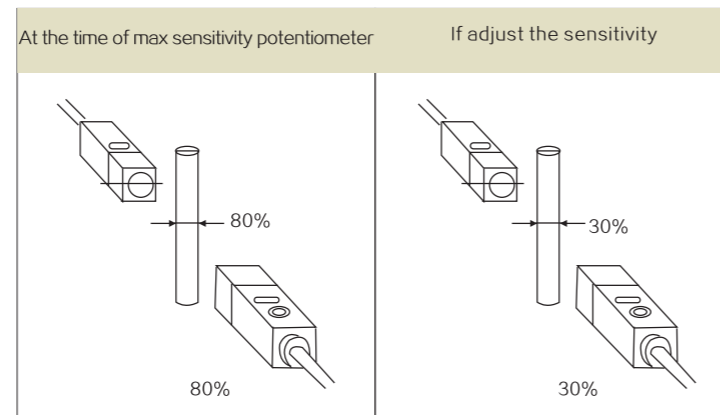



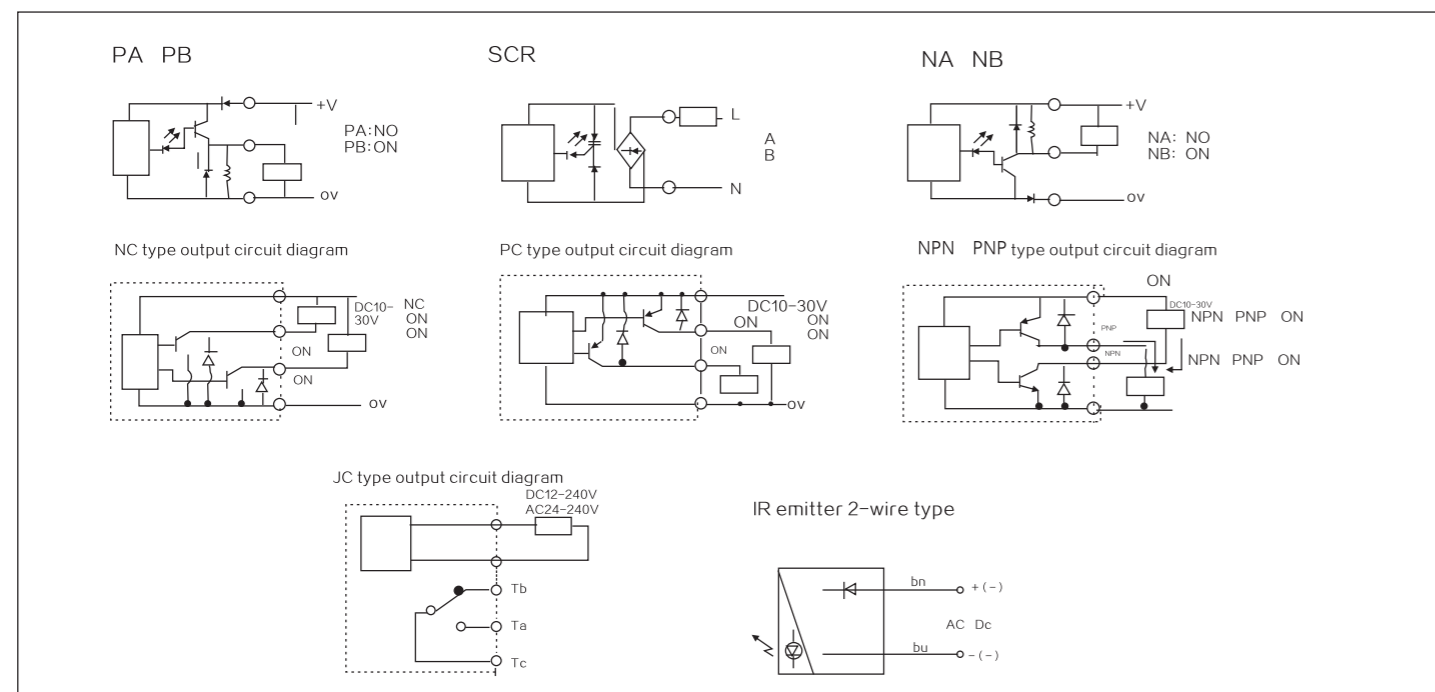

Output return diagram of photoelectric switch





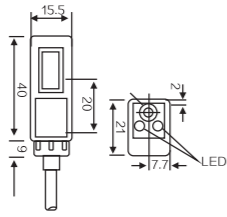
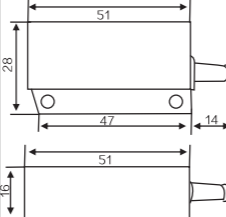
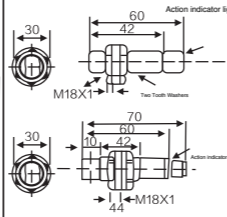
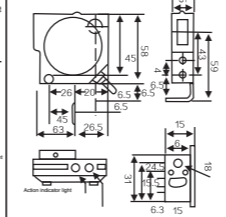

Structural category		Photoelectric switch					
Outward appearance code		G12	G13	G14	G15		
Outward appearance illustration							
Overall dimensions							
Diffuse Type	10-30 VDC	NPN	Detection distance	7cm	10cm	10cm	10cm
			NO	CZ G12-3A07NA	CZ G13-3A10NA	CZ G14-3A10NA	CZ G15-3A10NA
			NC	CZ G12-3A07NB	CZ G13-3A10NB	CZ G14-3A10NB	CZ G15-3A10NB
		NO+NC	CZ G12-3A07NC	CZ G13-3A10NC	CZ G14-3A10NC	CZ G15-3A10NC	
		PNP	NO	CZ G12-3A07PA	CZ G13-3A07PA	CZ G14-3A07PA	CZ G15-3A07PA
			NC	CZ G12-3A07PB	CZ G13-3A07PB	CZ G14-3A07PB	CZ G15-3A07PB
	NO+NC		CZ G12-3A07PC	CZ G13-3A07PC	CZ G14-3A07PC	CZ G15-3A07PC	
	90-250 AVC	SCR Controlable silicon	NO				
			NC				
	Relay output						
Retroreflective	10-30 VDC	NPN	Detection distance	1m	1m	1m	1m
			NO	CZ G12-3B1NA	CZ G13-3B1NA	CZ G14-3B1NA	CZ G15-3B1NA
			NC	CZ G12-3B1NB	CZ G13-3B1NB	CZ G14-3B1NB	CZ G15-3B1NB
		NO+NC	CZ G12-3B1NC	CZ G13-3B1NC	CZ G14-3B1NC	CZ G15-3B1NC	
		PNP	NO	CZ G12-3B1PA	CZ G13-3B1PA	CZ G14-3B1PA	CZ G15-3B1PA
			NC	CZ G12-3B1PB	CZ G13-3B1PB	CZ G14-3B1PB	CZ G15-3B1PB
	NO+NC		CZ G12-3B1PC	CZ G13-3B1PC	CZ G14-3B1PC	CZ G15-3B1PC	
	90-250 AVC	SCR Controlable silicon	NO				
			NC				
	Relay output						
Trough beam	10-30 VDC	NPN	Detection distance	3m	3m	3m	3m
			NO	CZ G12-3C3NA	CZ G13-3C3NA	CZ G14-3C3NA	CZ G15-3C3NA
			NC	CZ G12-3C3NB	CZ G13-3C3NB	CZ G14-3C3NB	CZ G15-3C3NB
		NO+NC	CZ G12-3C3NC	CZ G13-3C3NC	CZ G14-3C3NC	CZ G15-3C3NC	
		正逻辑 PNP	NO	CZ G12-3C3PA	CZ G13-3C3PA	CZ G14-3C3PA	CZ G15-3C3PA
			NC	CZ G12-3C3PB	CZ G13-3C3PB	CZ G14-3C3PB	CZ G15-3C3PB
	NO+NC		CZ G12-3C3PC	CZ G13-3C3PC	CZ G14-3C3PC	CZ G15-3C3PC	
	90-250 AVC	SCR Controlable silicon	NO				
			NC				
	Relay output						
DC/SCR/ Control output		DC:200mA					
DC/AC Consumption current		DC<15mA					
DC/AC Response time		Dc<2ms					
Directional angle		3° - 10°					
Detected object		transparent or opaque body					
Working environment temperature		-25°C ~ +55°C					
Intensity of illumination of working environment		10000LX Sunlight under 10000LX 3000LX incandescent lamp under 3000LX					
Shell material		Metal	Metal	Plastic	Plastic, Metal		
Protection grade		IP54	IP54	IP54	IP54		

PHOTOELECTRIC SWITCH

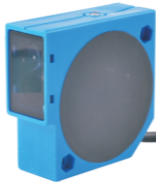

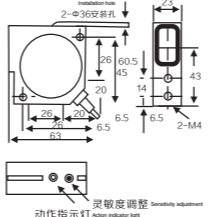
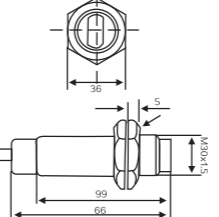
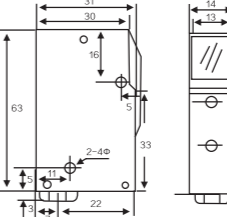
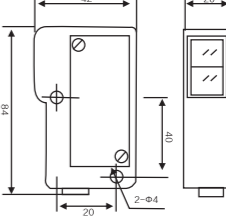
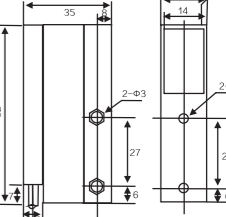

PHOTOELECTRIC SWITCH





Structural category		Photoelectric switch					
Outward appearance code		G16	G17	G18	G23		
Outward appearance illustration							
Overall dimensions							
Diffuse Type	10-30 VDC	NPN	Detection distance	10cm	30cm	10cm-30cm	10cm-50cm
			NO	CZ G16-3A10NA	CZ G17-3A30NA	CZ G18-3A10NA	CZ G23-3A10NA
			NC	CZ G16-3A10NB	CZ G17-3A30NB	CZ G18-3A10NB	CZ G23-3A10NB
		NO+NC	CZ G16-3A10NC	CZ G17-3A30NC	CZ G18-3A10NC	CZ G23-3A10NC	
		PNP	NO	CZ G16-3A10PA	CZ G17-3A30PA	CZ G18-3A10PA	CZ G23-3A10PA
			NC	CZ G16-3A10PB	CZ G17-3A30PB	CZ G18-3A10PB	CZ G23-3A10PB
	NO+NC		CZ G16-3A10PC	CZ G17-3A30PC	CZ G18-3A10PC	CZ G23-3A10PC	
	90-250 VAC	SCR Controlable silicon	NO			CZ G18-2A10LA	
			NC			CZ G18-2A10LB	
	Relay output						
Retroreflective	10-30 VDC	NPN	Detection distance	1m	2m	2m	2m
			NO	CZ G16-3B1NA	CZ G17-3B2NA	CZ G18-3B2NA	CZ G23-3B2NA
			NC	CZ G16-3B1NB	CZ G17-3B2NB	CZ G18-3B2NB	CZ G23-3B2NB
		NO+NC	CZ G16-3B1NC	CZ G17-3B2NC	CZ G18-3B2NC	CZ G23-3B2NC	
		PNP	NO	CZ G16-3B1PA	CZ G17-3B2PA	CZ G18-3B2PA	CZ G23-3B2PA
			NC	CZ G16-3B1PB	CZ G17-3B2PB	CZ G18-3B2PB	CZ G23-3B2PB
	NO+NC		CZ G16-3B1PC	CZ G17-3B2PC	CZ G18-3B2PC	CZ G23-3B2PC	
	90-250 VAC	SCR Controlable silicon	NO			CZ G18-2B2LA	
			NC			CZ G18-2B2LB	
	Relay output						
Trough beam	10-30 VDC	NPN	Detection distance	5m	3m	5m	5m
			NO	CZ G16-3C5NA	CZ G17-3C3NA	CZ G18-3C5NA	CZ G23-3C5NA
			NC	CZ G16-3C5NB	CZ G17-3C3NB	CZ G18-3C5NB	CZ G23-3C5NB
		NO+NC	CZ G16-3C5NC	CZ G17-3C3NC	CZ G18-3C5NC	CZ G23-3C5NC	
		PNP	NO	CZ G16-3C5PA	CZ G17-3C3PA	CZ G18-3C5PA	CZ G23-3C5PA
			NC	CZ G16-3C5PB	CZ G17-3C3PB	CZ G18-3C5PB	CZ G23-3C5PB
	NO+NC		CZ G16-3C5PC	CZ G17-3C3PC	CZ G18-3C5PC	CZ G23-3C5PC	
	90-250 VAC	SCR Controlable silicon	NO			CZ G18-2C5LA	
			NC			CZ G18-2C5LB	
	Relay output						
DC/SCR/ Control output		DC:200mA、AC:300mA					
DC/AC Consumption current		DC<15mA、AC:<10mA					
DC/AC Response time		Dc<2ms、AC<2ms					
Directional angle		3° -10°					
Detected object		transparent or opaque body					
Working environment temperature		-25℃~+55℃					
Intensity of illumination of working environment		10000LX Sunlight under 10000LX 3000LX incandescent lamp under 3000LX					
Shell material			Plastic	Plastic	Metal		
Protection grade		IP54	IP54	IP54	IP54		

Structural category		Photoelectric switch						
Outward appearance code		G24	G30	G33	G35	G36		
Outward appearance illustration								
Overall dimensions								
Diffuse Type	10-30 VDC	NPN	Detection distance	50cm	20-100cm	50cm	50cm	20cm
			NO	CZ G24-3A50NA	CZ G30-3A70NA	CZ G33-3A10NA	CZ G35-3A50NA	CZ G36-3A20NA
			NC	CZ G24-3A50NB	CZ G30-3A70NB	CZ G33-3A10NB	CZ G35-3A50NB	CZ G36-3A20NB
		NO+NC	CZ G24-3A50NC	CZ G30-3A70NC	CZ G33-3A10NC	CZ G35-3A50NC	CZ G36-3A20NC	
		PNP	NO	CZ G24-3A50PA	CZ G30-3A70PA	CZ G33-3A10PA	CZ G35-3A50PA	CZ G36-3A20PA
			NC	CZ G24-3A50PB	CZ G30-3A70PB	CZ G33-3A10PB	CZ G35-3A50PB	CZ G36-3A20PB
	NO+NC		CZ G24-3A50PC	CZ G30-3A70PC	CZ G33-3A10PC	CZ G35-3A50PC	CZ G36-3A20PC	
	90-250 VAC	SCR Controlable silicon	NO		CZ G30-2A70LA		CZ G35-2A50LA	
			NC		CZ G30-2A70LB		CZ G35-2A50LB	
	Relay output			CZ G30-2A70LC		CZ G35-2A50JC		
Retroreflective	10-30 VDC	NPN	Detection distance	4m	3m	1m	3m	2m
			NO	CZ G24-3B4NA	CZ G30-3B3NA	CZ G33-3B1NA	CZ G35-3B3NA	CZ G36-3B2NA
			NC	CZ G24-3B4NB	CZ G30-3B3NB	CZ G33-3B1NB	CZ G35-3B3NB	CZ G36-3B2NB
		NO+NC	CZ G24-3B4NC	CZ G30-3B3NC	CZ G33-3B1NC	CZ G35-3B3NC	CZ G36-3B2NC	
		PNP	NO	CZ G24-3B4PA	CZ G30-3B3PA	CZ G33-3B1PA	CZ G35-3B3PA	CZ G36-3B2PA
			NC	CZ G24-3B4PB	CZ G30-3B3PB	CZ G33-3B1PB	CZ G35-3B3PB	CZ G36-3B2PB
	NO+NC		CZ G24-3B4PC	CZ G30-3B3PC	CZ G33-3B1PC	CZ G35-3B3PC	CZ G36-3B2PC	
	90-250 VAC	SCR Controlable silicon	NO		CZ G30-2B3LA		CZ G35-2B3LA	
			NC		CZ G30-2B3LB		CZ G35-2B3LB	
	Relay output			CZ G30-2B3JC		CZ G35-2B3JC		
Trough beam	10-30 VDC	NPN	Detection distance	5m	10m	3m	5m	5m
			NO	CZ G24-3C5NA	CZ G30-3C101NA	CZ G33-3C3NA	CZ G35-3C5NA	CZ G36-3C5NA
			NC	CZ G24-3C5NB	CZ G30-3C101NB	CZ G33-3C3NB	CZ G35-3C5NB	CZ G36-3C5NB
		NO+NC	CZ G24-3C5NC	CZ G30-3C101NC	CZ G33-3C3NC	CZ G35-3C5NC	CZ G36-3C5NC	
		PNP	NO	CZ G24-3C5PA	CZ G30-3C101PA	CZ G33-3C3PA	CZ G35-3C5PA	CZ G36-3C5PA
			NC	CZ G24-3C5PB	CZ G30-3C101PB	CZ G33-3C3PB	CZ G35-3C5PB	CZ G36-3C5PB
	NO+NC		CZ G24-3C5PC	CZ G30-3C101PC	CZ G33-3C3PC	CZ G35-3C5PC	CZ G36-3C5PC	
	90-250 VAC	SCR Controlable silicon	NO		CZ G30-2C101LA		CZ G35-2C5LA	
			NC		CZ G30-2C101LB		CZ G35-2C5LB	
	Relay output			CZ G30-2C101JC		CZ G35-2C5JC		
DC/SCR/ Control output		DC:200mA、AC:300mA						
DC/AC Consumption current		DC<15mA、AC:<10mA						
DC/AC Response time		Dc<2ms、AC<20ms						
Directional angle		3° -10°						
Detected object		transparent or opaque body						
Working environment temperature		-25℃~+55℃						
Intensity of illumination of working environment		10000LX Sunlight under 10000LX 3000LX incandescent lamp under 3000LX						
Shell material		Plastic	Plastic	Plastic	Metal	Metal		
Protection grade		IP54	IP66	IP54	IP54	IP54		

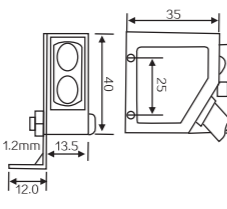
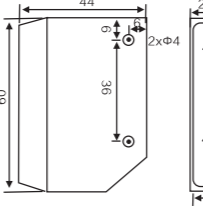
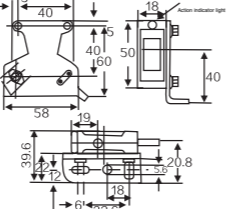
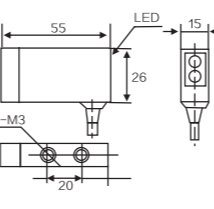
PHOTOELECTRIC SWITCH

PHOTOELECTRIC SWITCH

Structural category		Photoelectric switch					
Outward appearance code		G40	G44	G50	G54		
Outward appearance illustration							
Overall dimensions							
Diffuse Type	10-30 VDC	NPN	Detection distance	10cm-30cm	30cm	30cm 50cm	20cm
			NO	CZ G40-3A10NA	CZ G44-3A30NA	CZ G50-3A30NA	CZ G54-3A20NA
			NC	CZ G40-3A10NB	CZ G44-3A30NB	CZ G50-3A30NB	CZ G54-3A20NB
		NO+NC	CZ G40-3A10NC	CZ G44-3A30NC	CZ G50-3A30NC	CZ G54-3A20NC	
		PNP	NO	CZ G40-3A10PA	CZ G44-3A30PA	CZ G50-3A30PA	CZ G54-3A20PA
			NC	CZ G40-3A10PB	CZ G44-3A30PB	CZ G50-3A30PB	CZ G54-3A20PB
	NO+NC		CZ G40-3A10PC	CZ G44-3A30PC	CZ G50-3A30PC	CZ G54-3A20PC	
	90-250 VAC	SCR Controlable silicon	NO				
			NC				
	Relay output				G50-2A30JC		
Retroreflective	10-30 VDC	NPN	Detection distance	3m	3m	4m	2m
			NO	CZ G40-3B3NA	CZ G44-3B30NA	CZ G50-3B4NA	CZ G54-3B2NA
			NC	CZ G40-3B3NB	CZ G44-3B30NB	CZ G50-3B4NB	CZ G54-3B2NB
		NO+NC	CZ G40-3B3NC	CZ G44-3B30NC	CZ G50-3B4NC	CZ G54-3B2NC	
		PNP	NO	CZ G40-3B3PA	CZ G44-3B30PA	CZ G50-3B4PA	CZ G54-3B2PA
			NC	CZ G40-3B3PB	CZ G44-3B30PB	CZ G50-3B4PB	CZ G54-3B2PB
	NO+NC		CZ G40-3B3PC	CZ G44-3B30PC	CZ G50-3B4PC	CZ G54-3B2PC	
	90-250 VAC	SCR Controlable silicon	NO				
			NC				
	Relay output				G50-2B4JC		
Trough beam	10-30 VDC	NPN	Detection distance	4m	5m	5m	5m
			NO	CZ G40-4C4NA	CZ G44-3C5NA	CZ G50-3C5NA	
			NC	CZ G40-4C4NB	CZ G44-3C5NB	CZ G50-3C5NB	CZ G54-3C5NA
		NO+NC	CZ G40-4C4NC	CZ G44-3C5NC	CZ G50-3C5NC	CZ G54-3C5NB	
		PNP	NO	CZ G40-4C4PA	CZ G44-3C5PA	CZ G50-3C5PA	CZ G54-3C5NC
			NC	CZ G40-4C4PB	CZ G44-3C5PB	CZ G50-3C5PB	CZ G54-3C5PA
	NO+NC		CZ G40-4C4PC	CZ G44-3C5PC	CZ G50-3C5PC	CZ G54-3C5PB	
	90-250 VAC	SCR Controlable silicon	NO			CZ G50-2C5LA	CZ G54-3C5PC
			NC				
	Relay output				CZ G50-2C5JC		
DC/SCR/ Control output		DC:200mA AC:300mA relay:2A					
DC/AC Consumption current		DC<15mA AC:<10mA					
DC/AC Response time		Dc<2ms AC<20ms					
Directional angle		3° -10°					
Detected object		transparent or opaque body					
Working environment temperature		-25°C ~ -55°C					
Intensity of illumination of working environment		10000LX	Sunlight under 10000LX	3000LX	incandescent lamp under 3000LX		
Shell material		Metal	Metal	Plastic	Plastic		
Protection grade		IP50	IP54	IP54	IP54		

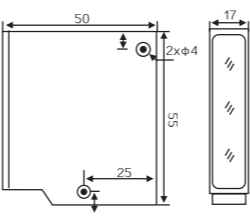
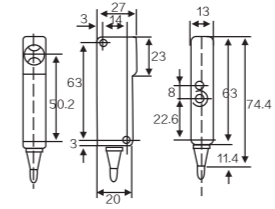
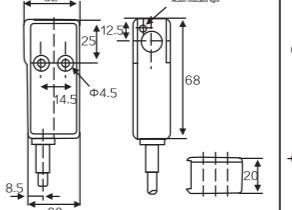
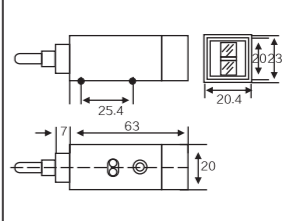
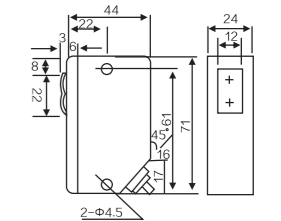
Structural category		Photoelectric switch					
Outward appearance code		G55	G64	G68	G70	G71	
Outward appearance illustration							
Overall dimensions							
Diffuse Type	10-30 VDC	NPN	Detection distance	20cm	10cm	30cm	20-100cm
			NO	CZ G55-3A20NA	CZ G64-3A10NA	CZ G68-3A30NA	CZ G70-3A20NA
			NC	CZ G55-3A20NB	CZ G64-3A10NB	CZ G68-3A30NB	CZ G70-3A20NB
		NO+NC	CZ G55-3A20NC	CZ G64-3A10NC	CZ G68-3A30NC	CZ G70-3A20NC	
		PNP	NO	CZ G55-3A20PA	CZ G64-3A10PA	CZ G68-3A30PA	CZ G70-3A20PA
			NC	CZ G55-3A20PB	CZ G64-3A10PB	CZ G68-3A30PB	CZ G70-3A20PB
	NO+NC		CZ G55-3A20PC	CZ G64-3A10PC	CZ G68-3A30PC	CZ G70-3A20PC	
	90-250 VAC	SCR Controlable silicon	NO				
			NC				
	Relay output						
Retroreflective	10-30 VDC	NPN	Detection distance	2m	1.5m-2m	2m	2m
			NO	CZ G55-3B2NA	CZ G64-3B2NA	CZ G68-3B2NA	CZ G70-3B2NA
			NC	CZ G55-3B2NB	CZ G64-3B2NB	CZ G68-3B2NB	CZ G70-3B2NB
		NO+NC	CZ G55-3B2NC	CZ G64-3B2NC	CZ G68-3B2NC	CZ G70-3B2NC	
		PNP	NO	CZ G55-3B2PA	CZ G64-3B2PA	CZ G68-3B2PA	CZ G70-3B2PA
			NC	CZ G55-3B2PB	CZ G64-3B2PB	CZ G68-3B2PB	CZ G70-3B2PB
	NO+NC		CZ G55-3B2PC	CZ G64-3B2PC	CZ G68-3B2PC	CZ G70-3B2PC	
	90-250 VAC	SCR Controlable silicon	NO				
			NC				
	Relay output						
Trough beam	10-30 VDC	NPN	Detection distance	4m	3m	5m	5m
			NO	CZ G55-3C4NA	CZ G64-3C3NA	CZ G68-3C5NA	CZ G70-3C5NA
			NC	CZ G55-3C4NB	CZ G64-3C3NB	CZ G68-3C5NB	CZ G70-3C5NB
		NO+NC	CZ G55-3C4NC	CZ G64-3C3NC	CZ G68-3C5NC	CZ G70-3C5NC	
		PNP	NO	CZ G55-3C4PA	CZ G64-3C3PA	CZ G68-3C5PA	CZ G70-3C5PA
			NC	CZ G55-3C4PB	CZ G64-3C3PB	CZ G68-3C5PB	CZ G70-3C5PB
	NO+NC		CZ G55-3C4PC	CZ G64-3C3PC	CZ G68-3C5PC	CZ G70-3C5PC	
	90-250 VAC	SCR Controlable silicon	NO				
			NC				
	Relay output						
DC/SCR/ Control output		DC:200mA AC:300mA					
DC/AC Consumption current		DC<15mA AC:<10mA					
DC/AC Response time		Dc<2ms AC<20ms					
Directional angle		3° -10°					
Detected object		transparent or opaque body					
Working environment temperature		-25°C ~ +55°C					
Intensity of illumination of working environment		10000LX	Sunlight under 10000LX	3000LX	incandescent lamp under 3000LX		
Shell material		Metal	Plastic	Plastic	Plastic		
Protection grade		IP54	IP66	IP54	IP54		

PHOTOELECTRIC SWITCH



PHOTOELECTRIC SWITCH



Structural category		Photoelectric switch						
Outward appearance code		G72	G180	G75	G76			
Outward appearance illustration								
Overall dimensions								
Diffuse Type	10-30 VDC	NPN	Detection distance	40cm	10cm	80cm	1m	
			NO	CZ G72-3A40NA	CZ G180-3A10NA	CZ G75-3A80NA	CZ G76-3A1NA	
			NC	CZ G72-3A40NB	CZ G180-3A10NB	CZ G75-3A80NB	CZ G76-3A1NB	
		NO+NC	CZ G72-3A40NC	CZ G180-3A10NC	CZ G75-3A80NC	CZ G76-3A1NC		
		PNP	NO	CZ G72-3A40PA	CZ G180-3A10PA	CZ G75-3A80PA	CZ G76-3A1PA	
			NC	CZ G72-3A40PB	CZ G180-3A10PB	CZ G75-3A80PB	CZ G76-3A1PB	
	NO+NC		CZ G72-3A40PC	CZ G180-3A10PC	CZ G75-3A80PC	CZ G76-3A1PC		
	90-250 VAC	SCR Controltable silicon	NO	CZ G180-2A10LA	CZ G75-2A80LA	CZ G76-2A1LA		
			NC	CZ G180-2A10LB	CZ G75-2A80LB	CZ G76-2A1LB		
			Relay output		CZ G75-2A80JC	CZ G76-2A1JC		
	Retroreflective	10-30 VDC	NPN	Detection distance	3m	2m	3m	5m
				NO	CZ G72-3B3NA	CZ G180-3B2NA	CZ G75-3B3NA	CZ G76-3B5NA
NC				CZ G72-3B3NB	CZ G180-3B2NB	CZ G75-3B3NB	CZ G76-3B5NB	
NO+NC			CZ G72-3B3NC	CZ G180-3B2NC	CZ G75-3B3NC	CZ G76-3B5NC		
PNP			NO	CZ G72-3B3PA	CZ G180-3B2PA	CZ G75-3B3PA	CZ G76-3B5PA	
			NC	CZ G72-3B3PB	CZ G180-3B2PB	CZ G75-3B3PB	CZ G76-3B5PB	
		NO+NC	CZ G72-3B3PC	CZ G180-3B2PC	CZ G75-3B3PC	CZ G76-3B5PC		
90-250 VAC		SCR Controltable silicon	NO	CZ G180-2B2LA	CZ G75-2B3LA	CZ G76-2B5LA		
			NC	CZ G180-2B2LB	CZ G75-2B3LB	CZ G76-2B5LB		
			Relay output		CZ G75-2B3JC	CZ G76-2B5JC		
Trough beam		10-30 VDC	NPN	Detection distance	5m	5m	8m	10m-50m
				NO	CZ G72-3C5NA	CZ G180-3C5NA	CZ G75-3C8NA	CZ G76-3C101NA
	NC			CZ G72-3C5NB	CZ G180-3C5NB	CZ G75-3C8NB	CZ G76-3C101NB	
	NO+NC		CZ G72-3C5NC	CZ G180-3C5NC	CZ G75-3C8NC	CZ G76-3C101NC		
	PNP		NO	CZ G72-3C5PA	CZ G180-3C5PA	CZ G75-3C8PA	CZ G76-3C101PA	
			NC	CZ G72-3C5PB	CZ G180-3C5PB	CZ G75-3C8PB	CZ G76-3C101PB	
		NO+NC	CZ G72-3C5PC	CZ G180-3C5PC	CZ G75-3C8PC	CZ G76-3C101PC		
	90-250 VAC	SCR Controltable silicon	NO	CZ G180-2C5LA	CZ G75-2C8LA	CZ G76-2C101LA		
			NC	CZ G180-2C5LB	CZ G75-2C8LB	CZ G76-2C101LB		
			Relay output		CZ G75-2C8JC	CZ G76-2C101JC		
	DC/SCR/ Control output		DC:200mA AC:300mA relay:2A					
	DC/AC Consumption current		DC<15mA AC:<10mA					
DC/AC Response time		Dc<2ms AC<20ms						
Directional angle		3° -10°						
Detected object		transparent or opaque body						
Working environment temperature		-25°C ~ +55°C						
Intensity of illumination of working environment		10000LX Sunlight under 10000LX 3000LX incandescent lamp under 3000LX						
Shell material		Metal Plastic Metal Plastic						
Protection grade		IP54 IP66 IP54 IP54						

Structural category		光电开关 Photoelectric switch						
Outward appearance code		G77	G78	G80	G85	GEN		
Outward appearance illustration								
Overall dimensions								
Diffuse Type	10-30 VDC	NPN	Detection distance	30cm	40cm	80cm	1m	
			NO	CZ G77-3A30NA	CZ G78-3A40NA	CZ G80-3A80NA	CZ G85-3A1NA	
			NC	CZ G77-3A30NB	CZ G78-3A40NB	CZ G80-3A80NB	CZ G85-3A1NB	
		PNP	NO	CZ G77-3A30NC	CZ G78-3A40NC	CZ G80-3A80NC	CZ G85-3A1NC	
			NC	CZ G77-3A30PA	CZ G78-3A40PA	CZ G80-3A80PA	CZ G85-3A1PA	
			NO+NC	CZ G77-3A30PB	CZ G78-3A40PB	CZ G80-3A80PB	CZ G85-3A1PB	
	90-250 VAC	SCR Controltable silicon	NO	CZ G77-3A30PC	CZ G78-3A40PC	CZ G80-3A80PC	CZ G85-3A1PC	
			NC	CZ G77-2A30LA	CZ G78-2A40LA	CZ G80-2A80LA	CZ G85-2A1LA	
			Relay output		CZ G78-2A40LB	CZ G80-2A80LB	CZ G85-2A1LB	
	Retroreflective	10-30 VDC	NPN	Detection distance	3m	2m	3m	5m
				NO	CZ G77-3B3NA	CZ G78-3B2NA	CZ G80-3B3NA	CZ G85-3B5NA
				NC	CZ G77-3B3NB	CZ G78-3B2NB	CZ G80-3B3NB	CZ G85-3B5NB
NO+NC			CZ G77-3B3NC	CZ G78-3B2NC	CZ G80-3B3NC	CZ G85-3B5NC		
PNP			NO	CZ G77-3B3PA	CZ G78-3B2PA	CZ G80-3B3PA	CZ G85-3B5PA	
			NC	CZ G77-3B3PB	CZ G78-3B2PB	CZ G80-3B3PB	CZ G85-3B5PB	
		NO+NC	CZ G77-3B3PC	CZ G78-3B2PC	CZ G80-3B3PC	CZ G85-3B5PC		
90-250 VAC		SCR Controltable silicon	NO	CZ G77-2B3LA	CZ G78-2B2LA	CZ G80-2B3LA	CZ G85-2B5LA	
			NC	CZ G77-2B3LB	CZ G78-2B2LB	CZ G80-2B3LB	CZ G85-2B5LB	
			Relay output		CZ G78-2B2LB	CZ G80-2B3JC	CZ G85-2B5JC	
Trough beam		10-30 VDC	NPN	Detection distance	5m	5m	5m	10m
				NO	CZ G77-3C5NA	CZ G78-3C5NA	CZ G80-3C5NA	CZ G85-3C101NA
	NC			CZ G77-3C5NB	CZ G78-3C5NB	CZ G80-3C5NB	CZ G85-3C101NB	
	PNP		NO	CZ G77-3C5NC	CZ G78-3C5NC	CZ G80-3C5NC	CZ G85-3C101NC	
			NC	CZ G77-3C5PA	CZ G78-3C5PA	CZ G80-3C5PA	CZ G85-3C101PA	
			NO+NC	CZ G77-3C5PB	CZ G78-3C5PB	CZ G80-3C5PB	CZ G85-3C101PB	
	90-250 VAC	SCR Controltable silicon	NO	CZ G77-3C5PC	CZ G78-3C5PC	CZ G80-3C5PC	CZ G85-3C101PC	
			NC	CZ G77-2C5LA	CZ G78-2C5LA	CZ G80-2C5LA	CZ G85-2C101LA	
			Relay output		CZ G78-2C5LB	CZ G80-2C5LB	CZ G85-2C101LB	
	DC/SCR/ Control output		DC:200mA AC:300mA					
	DC/AC Consumption current		DC<15mA AC:<10mA					
	DC/AC Response time		DC<2ms AC<20ms					
Directional angle		3° -10°						
Detected object		transparent or opaque body						
Working environment temperature		-25°C ~ +55°C						
Intensity of illumination of working environment		10000LX Sunlight under 10000LX 3000LX incandescent lamp under 3000LX						
Shell material		Plastic Plastic Plastic Metal Plastic						
Protection grade		IP54 IP54 IP54 IP54 IP54						

PHOTOELECTRIC SWITCH

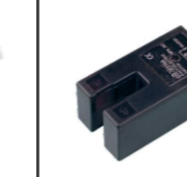
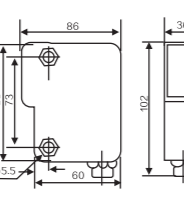
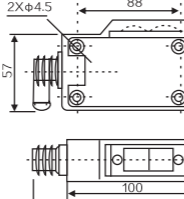
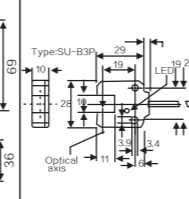
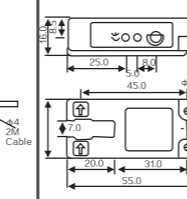
PHOTOELECTRIC SWITCH

Structural category		Photoelectric switch					
Outward appearance code		G100	G139	G51	G56		
Outward appearance illustration							
Overall dimensions							
Diffuse Type	10-30 VDC	NPN	Detection distance	1m	1m		
			NO	CZ G100-3A1NA	CZ G139-3A1NA		
			NC	CZ G100-3A1NB	CZ G139-3A1NB		
		NO+NC	CZ G100-3A1NC	CZ G139-3A1NC			
		PNP	NO	CZ G100-3A1PA	CZ G139-3A1PA		
			NC	CZ G100-3A1PB	CZ G139-3A1PB		
	NO+NC		CZ G100-3A1PC	CZ G139-3A1PC			
	90-250 VAC	SCR Controlable silicon	NO	CZ G100-2A1LA	CZ G139-2A1LA		
			NC	CZ G100-2A1LB	CZ G139-2A1LB		
		Relay output	CZ G100-2A1JC	CZ G139-2A1JC			
	Retroreflective	10-30 VDC	NPN	Detection distance	5m	5m	
				NO	CZ G100-3B5NA	CZ G139-3B5NA	
NC				CZ G100-3B5NB	CZ G139-3B5NB		
NO+NC			CZ G100-3B5NC	CZ G139-3B5NC			
PNP			NO	CZ G100-3B5PA	CZ G139-3B5PA		
			NC	CZ G100-3B5PB	CZ G139-3B5PB		
		NO+NC	CZ G100-3B5PC	CZ G139-3B5PC			
90-250 VAC		SCR Controlable silicon	NO	CZ G100-2B5LA	CZ G139-2B5LA		
			NC	CZ G100-2B5LB	CZ G139-2B5LB		
		Relay output	CZ G100-2B5JC	CZ G139-2B5JC			
Through beam		10-30 VDC	NPN	Detection distance	10m	10m	1cm
				NO	CZ G100-3C101NA	CZ G139-3C101NA	CZ G51-3E01NA
	NC			CZ G100-3C101NB	CZ G139-3C101NB	CZ G51-3E01NB	
	NO+NC		CZ G100-3C101NC	CZ G139-3C101NC	CZ G51-3E01NC		
	PNP		NO	CZ G100-3C101PA	CZ G139-3C101PA	CZ G51-3E01PA	
			NC	CZ G100-3C101PB	CZ G139-3C101PB	CZ G51-3E01PB	
		NO+NC	CZ G100-3C101PC	CZ G139-3C101PC	CZ G51-3E01PC		
	90-250 VAC	SCR Controlable silicon	NO	CZ G100-2C101LA	CZ G139-2C101LA		
			NC	CZ G100-2C101LB	CZ G139-2C101LB		
		Relay output	CZ G100-2C101JC	CZ G139-2C101JC			
	DC/SCR/ Control output		DC:200mA, AC:300mA relay:2A				
	DC/AC Consumption current		DC<15mA, AC:<10mA				
DC/AC Response time		DC<2mS, AC<20ms					
Directional angle		3° -10°					
Detected object		transparent or opaque body					
Working environment temperature		-25°C ~+55°C					
Intensity of illumination of working environment		10000LX	Sunlight under 10000LX	3000LX	incandescent lamp under 3000LX		
Shell material		Metal	Aluminum/plastic	Plastic	Plastic		
Protection grade		IP54	IP54	IP54	IP54		

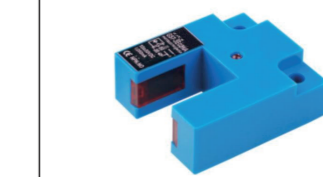
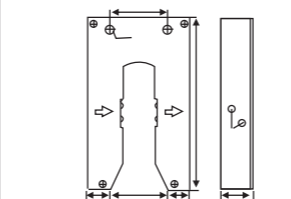
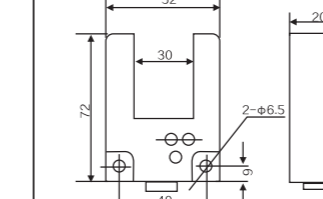
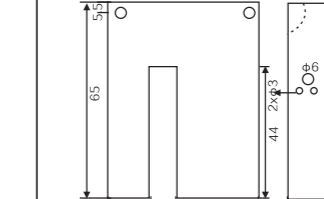
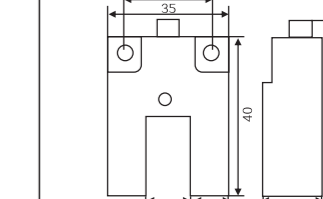
Structural category		Photoelectric switch					
Outward appearance code		G115	G63	G65	G57		
Outward appearance illustration							
Overall dimensions							
Diffuse Type	10-30 VDC	NPN	Detection distance	25mm	3cm	1cm	
			NO	CZ G115-3E25NA	CZ G63-3E03NA	CZ G65-3E01NA	
			NC	CZ G115-3E25NB	CZ G63-3E03NB	CZ G65-3E01NB	
		NO+NC	CZ G115-3E25NC	CZ G63-3E03NC	CZ G65-3E01NC		
		PNP	NO	CZ G115-3E25PA	CZ G63-3E03PA	CZ G65-3E01PA	
			NC	CZ G115-3E25PB	CZ G63-3E03PB	CZ G65-3E01PB	
	NO+NC		CZ G115-3E25PC	CZ G63-3E03PC	CZ G65-3E01PC		
	90-250 VAC	SCR Controlable silicon	NO				
			NC				
		Relay output					
	Retroreflective	10-30 VDC	NPN	Detection distance	25mm	3cm	1cm
				NO	CZ G115-3E25NA	CZ G63-3E03NA	CZ G65-3E01NA
NC				CZ G115-3E25NB	CZ G63-3E03NB	CZ G65-3E01NB	
NO+NC			CZ G115-3E25NC	CZ G63-3E03NC	CZ G65-3E01NC		
PNP			NO	CZ G115-3E25PA	CZ G63-3E03PA	CZ G65-3E01PA	
			NC	CZ G115-3E25PB	CZ G63-3E03PB	CZ G65-3E01PB	
		NO+NC	CZ G115-3E25PC	CZ G63-3E03PC	CZ G65-3E01PC		
90-250 VAC		SCR Controlable silicon	NO				
			NC				
		Relay output					
DC/SCR/ Control output		DC:200mA AC:300mA					
DC/AC Consumption current		DC<15mA AC:<10mA					
DC/AC Response time		DC<2mS AC<20mS					
Directional angle		3° ~-10°					
Detected object		transparent or opaque body					
Working environment temperature		-25°C ~+55°C					
Intensity of illumination of working environment		10000LX	Sunlight under 10000LX	3000LX	incandescent lamp under 3000LX		
Shell material		Metal	Metal Plastic	Plastic	Plastic		
Protection grade		IP64	IP54				