

# PROXIMITY SWITCH

Structural category      Cylinder type      Connector type

Outward Appearance code      CZ LM8-□□T /LM8-□□T3      CZ LM12-□T /LM12-□T3      CZ LM18-□T

Outward appearance illustration



Overall dimensions

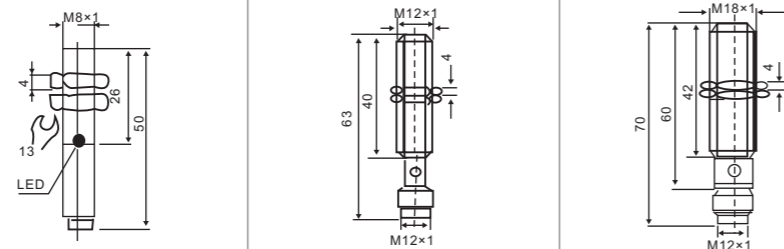

|                                     |                 | DETECTION DISTANCE  |                  |                  |                 |                 |                |
|-------------------------------------|-----------------|---|------------------|------------------|-----------------|-----------------|----------------|
|                                     |                 | 1mm   | 2mm              | 5mm              |                 |                 |                |
| Flush                               | DC 10-30 VDC    | NPN   | NO               | CZ LM8-3001NAT   | CZ LM12-3002NAT | CZ LM18-3005NAT |                |
|                                     |                 |   | NC               | CZ LM8-3001NBT   | CZ LM12-3002NBT | CZ LM18-3005NBT |                |
|                                     |                 |   | NO+NC            |                  | CZ LM12-3002NCT | CZ LM18-3005NCT |                |
|                                     |                 | PNP   | NO               | CZ LM8-3001PAT   | CZ LM12-3002PAT | CZ LM18-3005PAT |                |
|                                     |                 |   | NC               | CZ LM8-3001PBT   | CZ LM12-3002PBT | CZ LM18-3005PBT |                |
|                                     |                 |   | NO+NC            |                  | CZ LM12-3002PCT | CZ LM18-3005PCT |                |
|                                     | two wire system | NO  | CZ LM8-3001LAT   | CZ LM12-3002LAT  | CZ LM18-3005LAT |                 |                |
|                                     |                 | NC  | CZ LM8-3001LBT   | CZ LM12-3002LBT  | CZ LM18-3005LBT |                 |                |
|                                     | AC 90-250 VAC   | Control-lable silicon                                     | SCR              | NO               | CZ LM12-2002AT  | CZ LM18-2005AT  |                |
|                                     |                 |   | NC               |                  | CZ LM12-2002BT  | CZ LM18-2005BT  |                |
| NO+NC                               |                 |   |                  |                  |                 |                 |                |
| Relay output                        |                 |   |                  |                  |                 |                 |                |
|                                     |                 | DETECTION DISTANCE  |                  |                  |                 |                 |                |
|                                     |                 | 2mm   | 4mm              | 8mm              |                 |                 |                |
| Non-Flush                           | DC 10-30 VDC    | NPN   | NO               | CZ LM8-3002NAT   | CZ LM12-3004NAT | CZ LM18-3008NAT |                |
|                                     |                 |   | NC               | CZ LM8-3002NBT   | CZ LM12-3004NBT | CZ LM18-3008NBT |                |
|                                     |                 |   | NO+NC            |                  | CZ LM12-3004NCT | CZ LM18-3008NCT |                |
|                                     |                 | PNP   | NO               | CZ LM8-3002PAT   | CZ LM12-3004PAT | CZ LM18-3008PAT |                |
|                                     |                 |   | NC               | CZ LM8-3002PBT   | CZ LM12-3004PBT | CZ LM18-3008PBT |                |
|                                     |                 |   | NO+NC            |                  | CZ LM12-3004PCT | CZ LM18-3008PCT |                |
|                                     | two wire system | NO  | CZ LM8-3002LAT   | CZ LM12-3004LAT  | CZ LM18-3008LAT |                 |                |
|                                     |                 | NC  | CZ LM8-3002LBT   | CZ LM12-3004LBT  | CZ LM18-3008LBT |                 |                |
|                                     | AC 90-250 VAC   | Control-lable silicon                                     | SCR              | NO               | CZ LM8-2002AT   | CZ LM12-2004AT  | CZ LM18-2008AT |
|                                     |                 |   | NC               |                  | CZ LM12-2004BT  | CZ LM18-2008BT  |                |
| NO+NC                               |                 |   |                  |                  |                 |                 |                |
| Relay output                        |                 |   |                  |                  |                 |                 |                |
| Controloutput                       | DC              | 150mA   | 200mA            | 300mA            |                 |                 |                |
|                                     | SCR/Relay       |   |                  |                  |                 |                 |                |
| Output voltage drop DC/AC           |                 | (NPN PNP) 3V : 3.9V AC 10V DC < 3V AC < 10V               |                  |                  |                 |                 |                |
| Consumption current                 |                 | (NPN PNP) DC 12V 8mA 24V 15mA AC 10mA DC < 15mA AC < 10mA |                  |                  |                 |                 |                |
| Standard detected object            |                 | 8×8×1(A3 iron)  | 12×12×1(A3 iron) | 18×18×1(A3 iron) |                 |                 |                |
| Repeated precision                  |                 | 0.01  | 0.01             | 0.02             |                 |                 |                |
| DC/AC                               |                 | 500Hz/10Hz  | 400Hz/10Hz       | 200Hz/10Hz       |                 |                 |                |
| Working environment temperature     |                 | -25°C~+70°C   | -25°C~+70°C      | -25°C~+70°C      |                 |                 |                |
| Insulation resistance               |                 | 50MΩ  | 50MΩ             | 50MΩ             |                 |                 |                |
| Shell material                      |                 | Metal   | Metal            | Metal            |                 |                 |                |
| Protection grade                    |                 | IP67  | IP67             | IP67             |                 |                 |                |
| Alyemative model at home and abroad |                 | E2E-X1R5-M1   | E2E-X2E1-M1      | E2E-X5E5-M1      |                 |                 |                |

# PROXIMITY SWITCH

Structural category      Cylinder type

Outward Appearance code      CZ LM4/LM5      CZ LM6      CZ LM06      CZ LM8

Outward appearance illustration





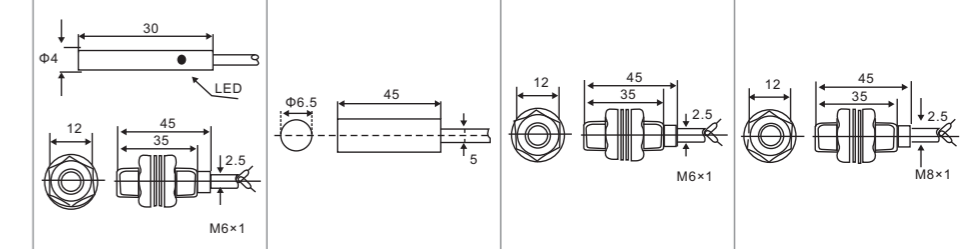

Overall dimensions





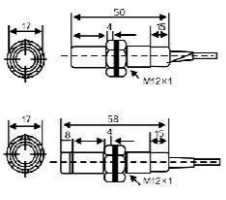
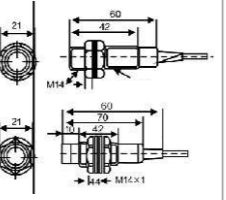
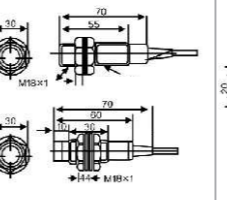
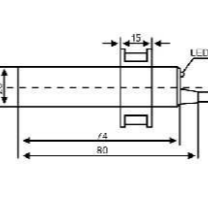

|                                     |                 | DETECTION DISTANCE  |                 |                              |                |                |               |
|-------------------------------------|-----------------|---|-----------------|------------------------------|----------------|----------------|---------------|
|                                     |                 | 0.8mm/1mm   | 1mm             | 1mm                          | 1mm            | 1mm            |               |
| Flush                               | DC 10-30 VDC    | NPN   | NO              | CZ LM4-300.8NA/CZ LM5-3001NA | CZ LM6-3001NA  | CZ LM06-3001NA | CZ LM8-3001NA |
|                                     |                 |   | NC              |                              | CZ LM6-3001NB  |                | CZ LM8-3001NB |
|                                     |                 |   | NO+NC           |                              |                |                | CZ LM8-3001NC |
|                                     |                 | PNP   | NO              | CZ LM4-300.8PA/CZ LM5-3001PA | CZ LM6-3001PA  | CZ LM06-3001PA | CZ LM8-3001PA |
|                                     |                 |   | NC              |                              | CZ LM6-3001PB  |                | CZ LM8-3001PB |
|                                     |                 |   | NO+NC           |                              |                |                | CZ LM8-3001PC |
|                                     | two wire system | NO  |                 | CZ LM6-3001LA                |                | CZ LM8-3001LA  |               |
|                                     |                 | NC  |                 | CZ LM6-3001LB                |                | CZ LM8-2001LB  |               |
|                                     | AC 90-250 VAC   | Control-lable silicon                                     | SCR             | NO                           | CZ LM6-2001A   |                | CZ LM8-2001A  |
|                                     |                 |   | NC              |                              | CZ LM6-2001B   |                | CZ LM8-2001B  |
| NO+NC                               |                 |   |                 |                              |                |                |               |
| Relay output                        |                 |   |                 |                              |                |                |               |
|                                     |                 | DETECTION DISTANCE  |                 | 1.5mm                        | 2mm            |                |               |
| Non-Flush                           | DC 10-30 VDC    | NPN   | NO              |                              | CZ LM6-3002NA  |                | CZ LM8-3002NA |
|                                     |                 |   | NC              |                              | CZ LM6-3002NB  |                | CZ LM8-3002NB |
|                                     |                 |   | NO+NC           |                              |                |                |               |
|                                     |                 | PNP   | NO              |                              | CZ LM6-3002PA  |                | CZ LM8-3002PA |
|                                     |                 |   | NC              |                              | CZ LM6-3002PB  |                | CZ LM8-3002PB |
|                                     |                 |   | NO+NC           |                              |                |                |               |
|                                     | two wire system | NO  |                 | CZ LM6-3002LA                |                | CZ LM8-3002LA  |               |
|                                     |                 | NC  |                 | CZ LM6-3002LB                |                | CZ LM8-3002LB  |               |
|                                     | AC 90-250 VAC   | Control-lable silicon                                     | SCR             | NO                           | CZ LM6-2002A   |                | CZ LM8-2002A  |
|                                     |                 |   | NC              |                              | CZ LM6-2002B   |                | CZ LM8-2002B  |
| NO+NC                               |                 |   |                 |                              |                |                |               |
| Relay output                        |                 |   |                 |                              |                |                |               |
| Controloutput                       | DC              | 200mA   | 200mA           | 200mA                        | 200mA          |                |               |
|                                     | SCR/Relay       |   |                 |                              |                |                |               |
| Output voltage drop DC/AC           |                 | (NPN PNP) 3V : 3.9V AC 10V DC < 3V AC < 10V               |                 |                              |                |                |               |
| Consumption current                 |                 | (NPN PNP) DC 12V 8mA 24V 15mA AC 10mA DC < 15mA AC < 10mA |                 |                              |                |                |               |
| Standard detected object            |                 | 6×6×1(A3 iron)  | 8×8×1(A3 iron)  | 8×8×1(A3 iron)               | 8×8×1(A3 iron) | 8×8×1(A3 iron) |               |
| Repeated precision                  |                 | 0.01  | 0.01            | 0.01                         | 0.01           | 0.01           |               |
| DC/AC                               |                 | 500Hz   | 500Hz           | 500Hz                        | 500Hz          | 500Hz/25Hz     |               |
| Working environment temperature     |                 | -25°C~+70°C   | -25°C~+75°C     | -25°C~+70°C                  | -25°C~+70°C    | -25°C~+75°C    |               |
| Insulation resistance               |                 | 50MΩ  | ≥30MΩ           | 50MΩ                         | 50MΩ           | ≥50MΩ          |               |
| Shell material                      |                 | Metal   | Stainless steel | Metal                        | Metal          | Metal          |               |
| Protection grade                    |                 | IP67  | IP67            | IP67                         | IP67           | IP67           |               |
| Alyemative model at home and abroad |                 |   |                 |                              |                | E2E-X1R5□□     |               |

# PROXIMITY SWITCH

| Structural category                 |                    | Cylinder type   |   |  |   |                |                |
|-------------------------------------|--------------------|---|---|--|---|----------------|----------------|
| Outward Appearance code             |                    | CZ LM12   | CZ LM14   | CZ LM18  | CZ LM20   |                |                |
| Outward appearance illustration     |                    |  |  |  |  |                |                |
| Overall dimensions                  |                    |  |  |  |  |                |                |
| Flush                               | DETECTION DISTANCE |   | 2mm   | 3mm  | 5mm   |                |                |
|                                     | DC 10-30 VDC       | NPN   | NO  | CZ LM12-3002NA   | CZ LM14-3003NA  | CZ LM18-3005NA |                |
|                                     |                    |   | NC  | CZ LM12-3002NB   | CZ LM14-3003NB  | CZ LM18-3005NB |                |
|                                     |                    |   | NO+NC   | CZ LM12-3002NC   | CZ LM14-3003NC  | CZ LM18-3005NC |                |
|                                     |                    | PNP   | NO  | CZ LM12-3002PA   | CZ LM14-3003PA  | CZ LM18-3005PA |                |
|                                     |                    |   | NC  | CZ LM12-3002PB   | CZ LM14-3003PB  | CZ LM18-3005PB |                |
|                                     |                    |   | NO+NC   | CZ LM12-3002PC   | CZ LM14-3003PC  | CZ LM18-3005PC |                |
|                                     | two wire system    | NO  | CZ LM12-3002LA  | CZ LM14-3003LA   | CZ LM18-3005LA  |                |                |
|                                     |                    | NC  | CZ LM12-2002LB  | CZ LM14-2003LB   | CZ LM18-3005LB  |                |                |
|                                     | AC 90-250 VAC      | Control-lable silicon   | NO  | CZ LM12-2002A  | CZ LM14-2003A   | CZ LM18-2005A  |                |
| NC                                  |                    |   | CZ LM12-2002B   | CZ LM14-2003B  | CZ LM18-2005B   |                |                |
| NO+NC                               |                    |   |   |  | CZ LM18-2005C   |                |                |
| Relay output                        |                    |   |   |  |   |                |                |
| Non-Flush                           | DETECTION DISTANCE |   | 4mm   | 5mm  | 8mm   | 10mm           |                |
|                                     | DC 10-30 VDC       | NPN   | NO  | CZ LM12-3004NA   | CZ LM14-3005NA  | CZ LM18-3008NA | CZ LM20-3010NA |
|                                     |                    |   | NC  | CZ LM12-3004NB   | CZ LM14-3005NB  | CZ LM18-3008NB | CZ LM20-3010NB |
|                                     |                    |   | NO+NC   | CZ LM12-3004NC   | CZ LM14-3005NC  | CZ LM18-3008NC | CZ LM20-3010NC |
|                                     |                    | PNP   | NO  | CZ LM12-3004PA   | CZ LM14-3005PA  | CZ LM18-3008PA | CZ LM20-3010PA |
|                                     |                    |   | NC  | CZ LM12-3004PB   | CZ LM14-3005PB  | CZ LM18-3008PB | CZ LM20-3010PB |
|                                     |                    |   | NO+NC   | CZ LM12-3004PC   | CZ LM14-3005PC  | CZ LM18-3008PC | CZ LM20-3010PC |
|                                     | two wire system    | NO  | CZ LM12-3004LA  | CZ LM14-3005LA   | CZ LM18-3008LA  | CZ LM20-3010LA |                |
|                                     |                    | NC  | CZ LM12-3004LB  | CZ LM14-3005LB   | CZ LM18-2008LB  | CZ LM20-3010LB |                |
|                                     | AC 90-250 VAC      | Control-lable silicon   | NO  | CZ LM12-2004A  | CZ LM14-2005A   | CZ LM18-2008A  | CZ LM20-2010A  |
| NC                                  |                    |   | CZ LM12-2004B   | CZ LM14-2005B  | CZ LM18-2008B   | CZ LM20-2010B  |                |
| NO+NC                               |                    |   |   |  | CZ LM18-2008C   | CZ LM20-2010C  |                |
| Relay output                        |                    |   |   |  |   |                |                |
| Controloutput                       | DC                 | 200mA   | 200mA   | 200mA  | 200mA   |                |                |
|                                     | SCR/Relay          | 300mA   | 300mA   | 300mA  | 300mA/1A  |                |                |
| Output voltage drop DC/AC           |                    | (NPN PNP) 3V :3.9V AC 10V DC<3V AC < 10V  |   |  |   |                |                |
| Consumption current                 |                    | (NPN PNP) DC 12V 8mA 24V 15mA AC 10mA DC<15mA AC<10mA                             |   |  |   |                |                |
| Standard detected object            |                    | 15×15×1(A3 iron)  | 15×15×1(A3 iron)  | 18×18×1(A3 iron)   | 20×20×1(A3 iron)  |                |                |
| Repeated precision                  |                    | 0.01  | 0.02  | 0.02   | 0.05  |                |                |
| DC/AC                               |                    | 400Hz/25Hz  | 300Hz/25Hz  | 200Hz/25Hz   | 200Hz/25Hz  |                |                |
| Working environment temperature     |                    | -25°C~+75°C   | -25°C~+75°C   | -25°C~+75°C  | -25°C~+75°C   |                |                |
| Insulation resistance               |                    | ≥50MΩ   | ≥50MΩ   | 50MΩ   | 50MΩ  |                |                |
| Shell material                      |                    | Metal   | Metal   | Metal  | ABS Resin   |                |                |
| Protection grade                    |                    | IP67  | IP67  | IP67   | IP67  |                |                |
| Alyemative model at home and abroad |                    | E2E-X5□□  | LJ14A3-□□   | LJ18A3-8-□□  |   |                |                |

# PROXIMITY SWITCH

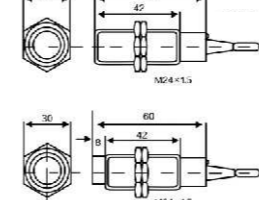
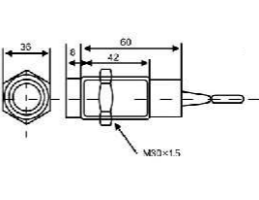
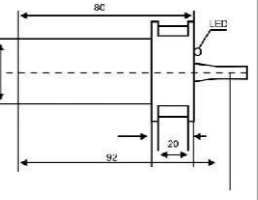
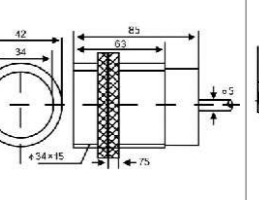
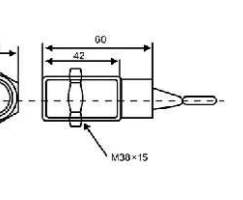
| Structural category                 |                    | Cylinder type   |   |   |   |   |                |                |
|-------------------------------------|--------------------|---|---|---|---|---|----------------|----------------|
| Outward Appearance code             |                    | CZ LM24   | CZ LM30   | CZ LM34   | CZ LM35   | CZ LM38   |                |                |
| Outward appearance illustration     |                    |  |  |  |  |  |                |                |
| Overall dimensions                  |                    |  |  |  |  |  |                |                |
| Flush                               | DETECTION DISTANCE |   | 8mm   | 10mm  |   | 12mm  |                |                |
|                                     | DC 10-30 VDC       | NPN   | NO  | CZ LM24-3008NA  | CZ LM30-3010NA  |   | CZ LM38-3012NA |                |
|                                     |                    |   | NC  | CZ LM24-3008NB  | CZ LM30-3010NB  |   | CZ LM38-3012NB |                |
|                                     |                    |   | NO+NC   | CZ LM24-3008NC  | CZ LM30-3010NC  |   | CZ LM38-3012NC |                |
|                                     |                    | PNP   | NO  | CZ LM24-3008PA  | CZ LM30-3010PA  |   | CZ LM38-3012PA |                |
|                                     |                    |   | NC  | CZ LM24-3008PB  | CZ LM30-3010PB  |   | CZ LM38-3012PB |                |
|                                     |                    |   | NO+NC   | CZ LM24-3008PC  | CZ LM30-3010PC  |   | CZ LM38-3012PC |                |
|                                     | two wire system    | NO  | CZ LM24-3008LA  | CZ LM30-3010LA  |   | CZ LM38-3012LA  |                |                |
|                                     |                    | NC  | CZ LM24-3008LB  | CZ LM30-3010LB  |   | CZ LM38-3012LB  |                |                |
|                                     | AC 90-250 VAC      | Control-lable silicon   | NO  | CZ LM24-2008A   | CZ LM30-2010A   |   | CZ LM38-2012A  |                |
| NC                                  |                    |   | CZ LM24-2008B   | CZ LM30-2010B   |   | CZ LM38-2012B   |                |                |
| NO+NC                               |                    |   | CZ LM24-2008C   | CZ LM30-2010C   |   | CZ LM38-2012C   |                |                |
| Relay output                        |                    |   | CZ LM30-2010JC  |   |   |   |                |                |
| Non-Flush                           | DETECTION DISTANCE |   | 10mm  | 15mm  | 17mm  | 17mm  | 18mm           |                |
|                                     | DC 10-30 VDC       | NPN   | NO  | CZ LM24-3010NA  | CZ LM30-3015NA  | CZ LM34-3017NA  | CZ LM35-3017NA | CZ LM38-3018NA |
|                                     |                    |   | NC  | CZ LM24-3010NB  | CZ LM30-3015NB  | CZ LM34-3017NB  | CZ LM35-3017NB | CZ LM38-3018NB |
|                                     |                    |   | NO+NC   | CZ LM24-3010NC  | CZ LM30-3015NC  | CZ LM34-3017NC  | CZ LM35-3017NC | CZ LM38-3018NC |
|                                     |                    | PNP   | NO  | CZ LM24-3010PA  | CZ LM30-3015PA  | CZ LM34-3017PA  | CZ LM35-3017PA | CZ LM38-3018PA |
|                                     |                    |   | NC  | CZ LM24-3010PB  | CZ LM30-3015PB  | CZ LM34-3017PB  | CZ LM35-3017PB | CZ LM38-3018PB |
|                                     |                    |   | NO+NC   | CZ LM24-3010PC  | CZ LM30-3015PC  | CZ LM34-3017PC  | CZ LM35-3017PC | CZ LM38-3018PC |
|                                     | two wire system    | NO  | CZ LM24-3010LA  | CZ LM30-3015LA  | CZ LM34-3017LA  | CZ LM35-3017LA  | CZ LM38-3018LA |                |
|                                     |                    | NC  | CZ LM24-3010LB  | CZ LM30-3015LB  | CZ LM34-3017LB  | CZ LM35-3017LB  | LCZ M38-3018LB |                |
|                                     | AC 90-250 VAC      | Control-lable silicon   | NO  | CZ LM24-2010A   | CZ LM30-2015A   | CZ LM34-2017A   | CZ LM35-2017A  | CZ LM38-2018A  |
| NC                                  |                    |   | CZ LM24-2010B   | CZ LM30-2015B   | CZ LM34-2017B   | CZ LM35-2017B   | CZ LM38-2018B  |                |
| NO+NC                               |                    |   | CZ LM24-2010C   | CZ LM30-2015C   | CZ LM34-2017C   | CZ LM35-2017C   | CZ LM38-2018C  |                |
| Relay output                        |                    |   | CZ LM30-2015JC  | CZ LM34-2017JC  | CZ LM35-2017JC  | CZ LM38-2018JC  |                |                |
| Controloutput                       | DC                 | 200mA   | 200mA   | 200mA   | 200mA   | 200mA   |                |                |
|                                     | SCR/Relay          | 300mA   | 300mA/1A  |   |   |   |                |                |
| Output voltage drop DC/AC           |                    | (NPN PNP) 3V :3.9V AC 10V DC<3V AC < 10V  |   |   |   |   |                |                |
| Consumption current                 |                    | (NPN PNP) DC 12V 8mA 24V 15mA AC 10mA DC<15mA AC<10mA                               |   |   |   |   |                |                |
| Standard detected object            |                    | 24×24×1(A3 iron)  | 30×30×1(A3 iron)  | 34×34×1(A3 iron)  | 40×40×1(A3 iron)  | 40×40×1(A3 iron)  |                |                |
| Repeated precision                  |                    | 0.05  | 0.05  |   | 0.1   |   |                |                |
| DC/AC                               |                    | 200Hz/25Hz  | 200Hz/25Hz  |   | 100Hz/15Hz  |   |                |                |
| Working environment temperature     |                    | -25°C~+75°C   | -25°C~+75°C   |   | -25°C~+75°C   |   |                |                |
| Insulation resistance               |                    | 50MΩ  | 50MΩ  |   | 50MΩ  |   |                |                |
| Shell material                      |                    | Metal   | Metal   | ABS Resin   | ABS Resin   | ABS Resin   |                |                |
| Protection grade                    |                    | IP67  | IP67  |   | IP67  |   |                |                |
| Alyemative model at home and abroad |                    | LJ24A3-10-□□  | E2E-X18M□   |   |   | LJ38A4-18-□□  |                |                |

# PROXIMITY SWITCH

Structural category: Cylinder type

Outward Appearance code: CZ LM39, CZ LM40, CZ LM480, CZ LM36

Outward appearance illustration



Overall dimensions

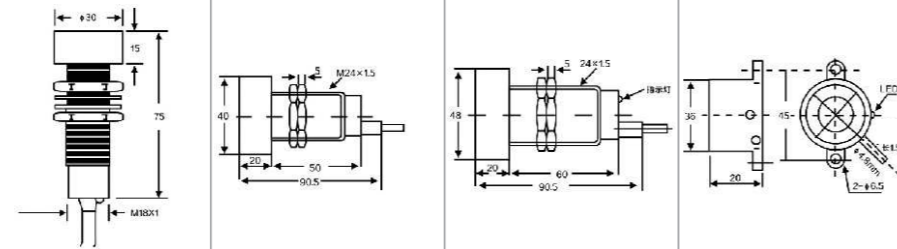

|                                     |               | DETECTION DISTANCE                                    |                  |                  |                  |                 |                |
|-------------------------------------|---------------|---|------------------|------------------|------------------|-----------------|----------------|
| Flush                               | DC 10-30 VDC  | NPN   | NO               |                  |                  |                 |                |
|                                     |               |   | NC               |                  |                  |                 |                |
|                                     |               |   | NO+NC            |                  |                  |                 |                |
|                                     |               | PNP   | NO               |                  |                  |                 |                |
|                                     |               |   | NC               |                  |                  |                 |                |
|                                     |               |   | NO+NC            |                  |                  |                 |                |
|                                     | AC 90-250 VAC | two wire system                                       | NO               |                  |                  |                 |                |
|                                     |               |   | NC               |                  |                  |                 |                |
|                                     |               | SCR   | NO               |                  |                  |                 |                |
|                                     |               | Control-lable silicon                                 | NC               |                  |                  |                 |                |
| Relay output                        |               |   |                  |                  |                  |                 |                |
|                                     |               | DETECTION DISTANCE                                    |                  |                  |                  |                 |                |
| Non-Flush                           | DC 10-30 VDC  | NPN   | NO               | CZ LM39-3015NA   | CZ LM40-3020NA   | CZ LM480-3025NA | CZ LM36-3015NA |
|                                     |               |   | NC               | CZ LM39-3015NB   | CZ LM40-3020NB   | CZ LM480-3025NB | CZ LM36-3015NB |
|                                     |               |   | NO+NC            | CZ LM39-3015NC   | CZ LM40-3020NC   | CZ LM480-3025NC | CZ LM36-3015NC |
|                                     |               | PNP   | NO               | CZ LM39-3015PA   | CZ LM40-3002PA   | CZ LM480-3025PA | CZ LM36-3015PA |
|                                     |               |   | NC               | CZ LM39-3015PB   | CZ LM40-3002PB   | CZ LM480-3025PB | CZ LM36-3015PB |
|                                     |               |   | NO+NC            | CZ LM39-3015PC   | CZ LM40-3020PC   | CZ LM480-3025PC | CZ LM36-3015PC |
|                                     | AC 90-250 VAC | two wire system                                       | NO               | CZ LM39-3015LA   | CZ LM40-3002LA   | CZ LM480-3025LA | CZ LM36-3015LA |
|                                     |               |   | NC               | CZ LM39-3015LB   | CZ LM40-3002LB   | CZ LM480-3025LB | CZ LM36-2015LB |
|                                     |               | SCR   | NO               | CZ LM39-2015A    | CZ LM40-2002A    | CZ LM480-2025A  | CZ LM36-2015A  |
|                                     |               | Control-lable silicon                                 | NC               | CZ LM39-2015B    | CZ LM40-2020B    | CZ LM480-2025B  | CZ LM36-2015B  |
| Relay output                        |               |   |                  | CZ LM40-2020JC   |                  |                 |                |
| Controloutput                       | DC            |   | 200mA            | 200mA            | 200mA            | 200mA           |                |
|                                     | SCR/Relay     |   | 300mA/1A         | 300mA/1A         |                  | 300mA           |                |
| Output voltage drop DC/AC           |               | (NPN PNP) 3V :3.9V AC 10V DC<3V AC<10V                |                  |                  |                  |                 |                |
| Consumption current                 |               | (NPN PNP) DC 12V 8mA 24V 15mA AC 10mA DC<15mA AC<10mA |                  |                  |                  |                 |                |
| Standard detected object            |               | 45×45×1(A3 iron)                                      | 45×45×1(A3 iron) | 50×50×1(A3 iron) | 45×45×1(A3 iron) |                 |                |
| Repeated precision                  |               |   | 0.1              |                  | 0.05             |                 |                |
| DC/AC                               |               |   | 100Hz/25Hz       |                  | 200Hz/10Hz       |                 |                |
| Working environment temperature     |               | -25°C~+75°C   |                  |                  |                  |                 |                |
| Insulation resistance               |               | 50MΩ  |                  |                  |                  |                 |                |
| Shell material                      |               | Metal   | Metal            | Metal            | ABS Resin        |                 |                |
| Protection grade                    |               | IP67  |                  |                  |                  |                 |                |
| Alyemative model at home and abroad |               | SC-□□   | SC-□□            | SFE-□□           |                  |                 |                |

# PROXIMITY SWITCH

Plane installation type: CZ LM42, CZ LM48, CZ LM55

Angular column type: CZ LMF1, CZ LMF2

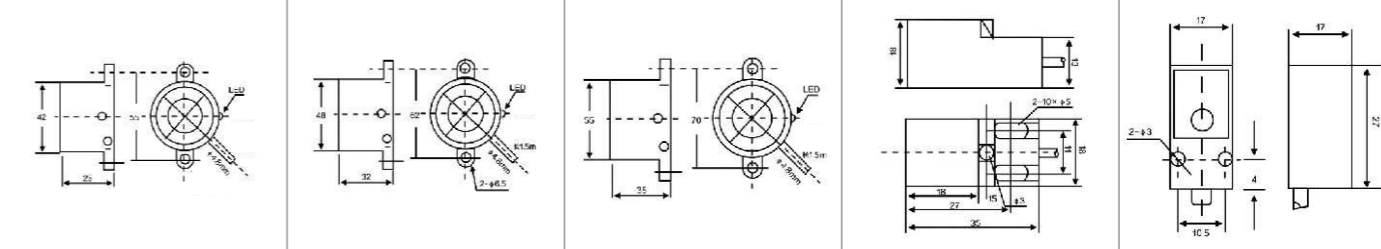

|              |               | DETECTION DISTANCE    |       |                | 5mm            |                | 5mm           |               |
|--------------|---------------|-----------------------|-------|----------------|----------------|----------------|---------------|---------------|
| Flush        | DC 10-30 VDC  | NPN                   | NO    |                |                |                |               |               |
|              |               |                       | NC    |                |                |                |               |               |
|              |               |                       | NO+NC |                |                |                |               |               |
|              |               | PNP                   | NO    |                |                |                |               |               |
|              |               |                       | NC    |                |                |                |               |               |
|              |               |                       | NO+NC |                |                |                |               |               |
|              | AC 90-250 VAC | two wire system       | NO    |                |                |                |               |               |
|              |               |                       | NC    |                |                |                |               |               |
|              |               | SCR                   | NO    |                |                |                |               |               |
|              |               | Control-lable silicon | NC    |                |                |                |               |               |
| Relay output |               |                       |       |                |                |                |               |               |
|              |               | DETECTION DISTANCE    |       |                | 5mm            |                | 5mm           |               |
| Non-Flush    | DC 10-30 VDC  | NPN                   | NO    | CZ LM42-3020NA | CZ LM48-3020NA | CZ LM55-3025NA |               |               |
|              |               |                       | NC    | CZ LM42-3020NB | CZ LM48-3020NB | CZ LM55-3025NB |               |               |
|              |               |                       | NO+NC | CZ LM42-3020NC | CZ LM48-3020NC | CZ LM55-3025NC |               |               |
|              |               | PNP                   | NO    | CZ LM42-3020PA | CZ LM48-3020PA | CZ LM55-3025PA |               |               |
|              |               |                       | NC    | CZ LM42-3020PB | CZ LM48-3020PB | CZ LM55-3025PB |               |               |
|              |               |                       | NO+NC | CZ LM42-3020PC | CZ LM48-3020PC | CZ LM55-3025PC |               |               |
|              | AC 90-250 VAC | two wire system       | NO    | CZ LM42-3020LA | CZ LM48-3020LA | CZ LM55-3025LA |               |               |
|              |               |                       | NC    | CZ LM42-2020LB | CZ LM48-2020LB | CZ LM55-2025LB |               |               |
|              |               | SCR                   | NO    | CZ LM42-2020A  | CZ LM48-2020A  | CZ LM55-2025A  | CZ LMF1-2005A | CZ LMF2-2005A |
|              |               | Control-lable silicon | NC    | CZ LM42-2020B  | CZ LM48-2020B  | CZ LM55-2025B  | CZ LMF1-2005B | CZ LMF2-2005B |
| Relay output |               |                       |       |                |                |                |               |               |
|              |               | DETECTION DISTANCE    |       |                | 5mm            |                | 5mm           |               |
| Flush        | DC 10-30 VDC  | NPN                   | NO    |                |                |                |               |               |
|              |               |                       | NC    |                |                |                |               |               |
|              |               |                       | NO+NC |                |                |                |               |               |
|              |               | PNP                   | NO    |                |                |                |               |               |
|              |               |                       | NC    |                |                |                |               |               |
|              |               |                       | NO+NC |                |                |                |               |               |
|              | AC 90-250 VAC | two wire system       | NO    |                |                |                |               |               |
|              |               |                       | NC    |                |                |                |               |               |
|              |               | SCR                   | NO    |                |                |                |               |               |
|              |               | Control-lable silicon | NC    |                |                |                |               |               |
| Relay output |               |                       |       |                |                |                |               |               |
|              |               | DETECTION DISTANCE    |       |                | 5mm            |                | 5mm           |               |
| Non-Flush    | DC 10-30 VDC  | NPN                   | NO    | CZ LM42-3020NA | CZ LM48-3020NA | CZ LM55-3025NA |               |               |
|              |               |                       | NC    | CZ LM42-3020NB | CZ LM48-3020NB | CZ LM55-3025NB |               |               |
|              |               |                       | NO+NC | CZ LM42-3020NC | CZ LM48-3020NC | CZ LM55-3025NC |               |               |
|              |               | PNP                   | NO    | CZ LM42-3020PA | CZ LM48-3020PA | CZ LM55-3025PA |               |               |
|              |               |                       | NC    | CZ LM42-3020PB | CZ LM48-3020PB | CZ LM55-3025PB |               |               |
|              |               |                       | NO+NC | CZ LM42-3020PC | CZ LM48-3020PC | CZ LM55-3025PC |               |               |
|              | AC 90-250 VAC | two wire system       | NO    | CZ LM42-3020LA | CZ LM48-3020LA | CZ LM55-3025LA |               |               |
|              |               |                       | NC    | CZ LM42-2020LB | CZ LM48-2020LB | CZ LM55-2025LB |               |               |
|              |               | SCR                   | NO    | CZ LM42-2020A  | CZ LM48-2020A  | CZ LM55-2025A  | CZ LMF1-2005A | CZ LMF2-2005A |
|              |               | Control-lable silicon | NC    | CZ LM42-2020B  | CZ LM48-2020B  | CZ LM55-2025B  | CZ LMF1-2005B | CZ LMF2-2005B |
| Relay output |               |                       |       |                |                |                |               |               |
|              |               | DETECTION DISTANCE    |       |                | 5mm            |                | 5mm           |               |
| Flush        | DC 10-30 VDC  | NPN                   | NO    |                |                |                |               |               |
|              |               |                       | NC    |                |                |                |               |               |
|              |               |                       | NO+NC |                |                |                |               |               |
|              |               | PNP                   | NO    |                |                |                |               |               |
|              |               |                       | NC    |                |                |                |               |               |
|              |               |                       | NO+NC |                |                |                |               |               |
|              | AC 90-250 VAC | two wire system       | NO    |                |                |                |               |               |
|              |               |                       | NC    |                |                |                |               |               |
|              |               | SCR                   | NO    |                |                |                |               |               |
|              |               | Control-lable silicon | NC    |                |                |                |               |               |
| Relay output |               |                       |       |                |                |                |               |               |
|              |               | DETECTION DISTANCE    |       |                | 5mm            |                | 5mm           |               |
| Non-Flush    | DC 10-30 VDC  | NPN                   | NO    | CZ LM42-3020NA | CZ LM48-3020NA | CZ LM55-3025NA |               |               |
|              |               |                       | NC    | CZ LM42-3020NB | CZ LM48-3020NB | CZ LM55-3025NB |               |               |
|              |               |                       | NO+NC | CZ LM42-3020NC | CZ LM48-3020NC | CZ LM55-3025NC |               |               |
|              |               | PNP                   | NO    | CZ LM42-3020PA | CZ LM48-3020PA | CZ LM55-3025PA |               |               |
|              |               |                       | NC    | CZ LM42-3020PB | CZ LM48-3020PB | CZ LM55-3025PB |               |               |
|              |               |                       | NO+NC | CZ LM42-3020PC | CZ LM48-3020PC | CZ LM55-3025PC |               |               |
|              | AC 90-250 VAC | two wire system       | NO    | CZ LM42-3020LA | CZ LM48-3020LA | CZ LM55-3025LA |               |               |
|              |               |                       | NC    | CZ LM42-2020LB | CZ LM48-2020LB | CZ LM55-2025LB |               |               |
|              |               | SCR                   | NO    | CZ LM42-2020A  | CZ LM48-2020A  | CZ LM55-2025A  | CZ LMF1-2005A | CZ LMF2-2005A |
|              |               | Control-lable silicon | NC    | CZ LM42-2020B  | CZ LM48-2020B  | CZ LM55-2025B  | CZ LMF1-2005B | CZ LMF2-2005B |
| Relay output |               |                       |       |                |                |                |               |               |
|              |               | DETECTION DISTANCE    |       |                | 5mm            |                | 5mm           |               |
| Flush        | DC 10-30 VDC  | NPN                   | NO    |                |                |                |               |               |
|              |               |                       | NC    |                |                |                |               |               |
|              |               |                       | NO+NC |                |                |                |               |               |
|              |               | PNP                   | NO    |                |                |                |               |               |
|              |               |                       | NC    |                |                |                |               |               |
|              |               |                       | NO+NC |                |                |                |               |               |
|              | AC 90-250 VAC | two wire system       | NO    |                |                |                |               |               |
|              |               |                       | NC    |                |                |                |               |               |
|              |               | SCR                   | NO    |                |                |                |               |               |
|              |               | Control-lable silicon | NC    |                |                |                |               |               |
| Relay output |               |                       |       |                |                |                |               |               |
|              |               | DETECTION DISTANCE    |       |                | 5mm            |                | 5mm           |               |
| Non-Flush    | DC 10-30 VDC  | NPN                   | NO    | CZ LM42-3020NA | CZ LM48-3020NA | CZ LM55-3025NA |               |               |
|              |               |                       | NC    | CZ LM42-3020NB | CZ LM48-3020NB | CZ LM55-3025NB |               |               |
|              |               |                       | NO+NC | CZ LM42-3020NC | CZ LM48-3020NC | CZ LM55-3025NC |               |               |
|              |               | PNP                   | NO    | CZ LM42-3020PA | CZ LM48-3020PA | CZ LM55-3025PA |               |               |
|              |               |                       | NC    | CZ LM42-3020PB | CZ LM48-3020PB | CZ LM55-3025PB |               |               |
|              |               |                       | NO+NC | CZ LM42-3020PC | CZ LM48-3020PC | CZ LM55-3025PC |               |               |
|              | AC 90-250 VAC | two wire system       | NO    | CZ LM42-3020LA | CZ LM48-3020LA | CZ LM55-3025LA |               |               |
|              |               |                       | NC    | CZ LM42-2020LB | CZ LM48-2020LB | CZ LM55-2025LB |               |               |
|              |               | SCR                   | NO    | CZ LM42-2020A  | CZ LM48-2020A  | CZ LM55-2025A  | CZ LMF1-2005A | CZ LMF2-2005A |
|              |               | Control-lable silicon | NC    | CZ LM42-2020B  | CZ LM48-2020B  | CZ LM55-2025B  | CZ LMF1-2005B | CZ LMF2-2005B |
| Relay output |               |                       |       |                |                |                |               |               |
|              |               | DETECTION DISTANCE    |       |                | 5mm            |                | 5mm           |               |
| Flush        | DC 10-30 VDC  | NPN                   | NO    |                |                |                |               |               |
|              |               |                       | NC    |                |                |                |               |               |
|              |               |                       | NO+NC |                |                |                |               |               |
|              |               | PNP                   | NO    |                |                |                |               |               |
|              |               |                       | NC    |                |                |                |               |               |
|              |               |                       | NO+NC |                |                |                |               |               |
|              | AC 90-250 VAC | two wire system       | NO    |                |                |                |               |               |
|              |               |                       | NC    |                |                |                |               |               |
|              |               | SCR                   | NO    |                |                |                |               |               |
|              |               | Control-lable silicon | NC    |                |                |                |               |               |
| Relay output |               |                       |       |                |                |                |               |               |
|              |               | DETECTION DISTANCE    |       |                | 5mm            |                | 5mm           |               |
| Non-Flush    | DC 10-30 VDC  | NPN                   | NO    | CZ LM42-3020NA | CZ LM48-3020NA | CZ LM55-3025NA |               |               |
|              |               |                       | NC    | CZ LM42-3020NB | CZ LM48-3020NB | CZ LM55-3025NB |               |               |
|              |               |                       | NO+NC | CZ LM42-3020NC | CZ LM48-3020NC | CZ LM55-3025NC |               |               |
|              |               | PNP                   | NO    | CZ LM42-3020PA | CZ LM48-3020PA | CZ LM55-3025PA |               |               |
|              |               |                       | NC    | CZ LM42-3020PB | CZ LM48-3020PB | CZ LM55-3025PB |               |               |
|              |               |                       | NO+NC | CZ LM42-3020PC | CZ LM48-3020PC | CZ LM55-3025PC |               |               |
|              | AC 90-250 VAC | two wire system       | NO    | CZ LM42-3020LA | CZ LM48-3020LA | CZ LM55-3025LA |               |               |
|              |               |                       | NC    | CZ LM42-2020LB | CZ LM48-2020LB | CZ LM55-2025LB |               |               |
|              |               | SCR                   | NO    | CZ LM42-2020A  | CZ LM48-2020A  | CZ LM55-2025A  | CZ LMF1-2005A | CZ LMF2-2005A |
|              |               | Control-lable silicon | NC    | CZ LM42-2020B  | CZ LM48-2020B  | CZ LM55-2025B  | CZ LMF1-2005B | CZ LMF2-2005B |
| Relay output |               |                       |       |                |                |                |               |               |
|              |               | DETECTION DISTANCE    |       |                | 5mm            |                | 5mm           |               |
| Flush        | DC 10-30 VDC  | NPN                   | NO    |                |                |                |               |               |
|              |               |                       | NC    |                |                |                |               |               |
|              |               |                       | NO+NC |                |                |                |               |               |
|              |               | PNP                   | NO    |                |                |                |               |               |
|              |               |                       | NC    |                |                |                |               |               |
|              |               |                       | NO+NC |                |                |                |               |               |
|              | AC 90-250 VAC | two wire system       | NO    |                |                |                |               |               |
|              |               |                       | NC    |                |                |                |               |               |
|              |               | SCR                   | NO    |                |                |                |               |               |
|              |               | Control-lable silicon | NC    |                |                |                |               |               |
| Relay output |               |                       |       |                |                |                |               |               |
|              |               | DETECTION DISTANCE    |       |                | 5mm            |                | 5mm           |               |
| Non-Flush    | DC 10-30 VDC  | NPN                   | NO    | CZ LM42-3020NA | CZ LM48-3020NA | CZ LM55-3025NA |               |               |
|              |               |                       | NC    | CZ LM42-3020NB | CZ LM48-3020NB | CZ LM55-3025NB |               |               |
|              |               |                       | NO+NC | CZ LM42-3020NC | CZ LM48-3020NC | CZ LM55-3025NC |               |               |
|              |               | PNP                   | NO    | CZ LM42-3020PA | CZ LM48-3020PA | CZ LM55-3025PA |               |               |
|              |               |                       | NC    | CZ LM42-3020PB | CZ LM48-3020PB | CZ LM55-3025PB |               |               |
|              |               |                       | NO+NC | CZ LM42-3020PC | CZ LM48-3020PC | CZ LM55-3025PC |               |               |
|              | AC 90-250 VAC | two wire system       | NO    | CZ LM42-3020LA | CZ LM48-3020LA | CZ LM55-3025LA |               |               |
|              |               |                       | NC    | CZ LM42-2020LB | CZ LM48-2020LB | CZ LM55-2025LB |               |               |
|              |               | SCR                   | NO    | CZ LM42-2020A  | CZ LM48-2020A  | CZ LM55-2025A  | CZ LMF1-2005A | CZ LMF2-2005A |
|              |               | Control-lable silicon | NC    | CZ LM42-2020B  | CZ LM48-2020B  | CZ LM55-2025B  | CZ LMF1-2005B | CZ LMF2-2005B |
| Relay output |               |                       |       |                |                |                |               |               |
|              |               | DETECTION DISTANCE    |       |                | 5mm            |                | 5mm           |               |
| Flush        | DC 10-30 VDC  | NPN                   | NO    |                |                |                |               |               |
|              |               |                       | NC    |                |                |                |               |               |

# PROXIMITY SWITCH

Structural category Angular column type

Outward Appearance code CZ LMF3 CZ LMF4 CZ LMF5 CZ LMF6

Outward appearance illustration

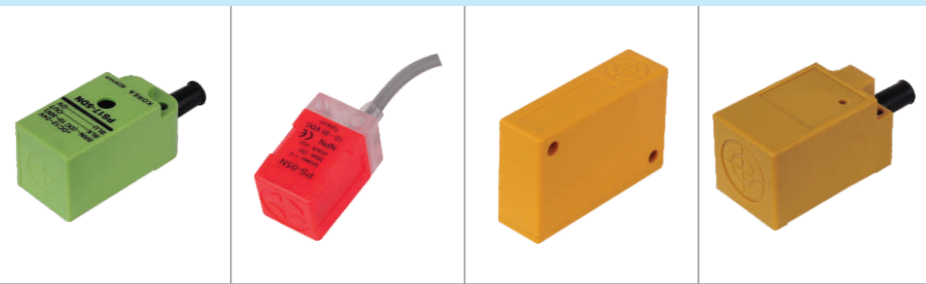

Overall dimensions

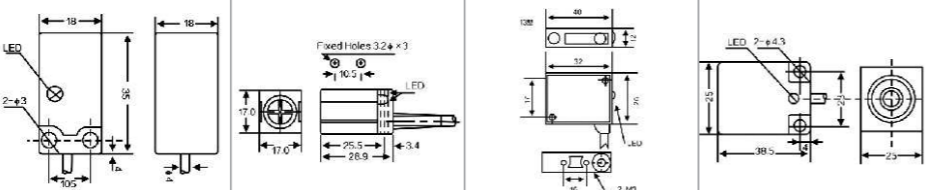

|                                     |               | DETECTION DISTANCE                                      |                  | 5mm              | 5mm              | 2mm            | 8mm            |
|-------------------------------------|---------------|---|------------------|------------------|------------------|----------------|----------------|
| Flush                               | DC 10-30 VDC  | NPN   | NO               | CZ LMF3-3005NA   | CZ LMF4-3005NA   | CZ LMF5-3002NA | CZ LMF6-3008NA |
|                                     |               |   | NC               | CZ LMF3-3005NB   | CZ LMF4-3005NB   | CZ LMF5-3002NB | CZ LMF6-3008NB |
|                                     |               |   | NO+NC            | CZ LMF4-3005NC   | CZ LMF5-3002NC   | CZ LMF6-3008NC |                |
|                                     |               | PNP   | NO               | CZ LMF3-3005PA   | CZ LMF4-3005PA   | CZ LMF5-3002PA | CZ LMF6-3008PA |
|                                     |               |   | NC               | CZ LMF3-3005PB   | CZ LMF4-3005PB   | CZ LMF5-3002PB | CZ LMF6-3008PB |
|                                     |               |   | NO+NC            | CZ LMF4-3005PC   | CZ LMF5-3002PC   | CZ LMF6-3008PC |                |
|                                     | AC 90-250 VAC | two wire system   | NO               | CZ LMF3-3005LA   | CZ LMF4-3005LA   | CZ LMF5-3002LA | CZ LMF6-3008LA |
|                                     |               |   | NC               | CZ LMF3-3005LB   | CZ LMF4-3005LB   | CZ LMF5-3002LB | CZ LMF6-3008LB |
|                                     |               | SCR   | NO               |                  |                  |                | CZ LMF6-2008A  |
|                                     |               |   | NC               |                  |                  |                | CZ LMF6-2008B  |
| Relay output                        |               |   |                  |                  |                  |                |                |
| Non-Flush                           | DC 10-30 VDC  | NPN   | NO               |                  |                  | CZ LMF5-3004NA | CZ LMF6-3010NA |
|                                     |               |   | NC               |                  |                  | CZ LMF5-3004NB | CZ LMF6-3010NB |
|                                     |               |   | NO+NC            |                  |                  | CZ LMF5-3004NC | CZ LMF6-3010NC |
|                                     |               | PNP   | NO               |                  |                  | CZ LMF5-3004PA | CZ LMF6-3010PA |
|                                     |               |   | NC               |                  |                  | CZ LMF5-3004PB | CZ LMF6-3010PB |
|                                     |               |   | NO+NC            |                  |                  | CZ LMF5-3004PC | CZ LMF6-3010PC |
|                                     | AC 90-250 VAC | two wire system   | NO               |                  |                  | CZ LMF5-3004LA | CZ LMF6-3010LA |
|                                     |               |   | NC               |                  |                  | CZ LMF5-3004LB | CZ LMF6-3010LB |
|                                     |               | SCR   | NO               | CZ LMF3-2005A    |                  |                | CZ LMF6-2010A  |
|                                     |               |   | NC               | CZ LMF3-2005B    |                  |                | CZ LMF6-2010B  |
| Relay output                        |               |   |                  |                  |                  |                |                |
| Control output                      | DC            |   | 200mA            | 200mA            | 200mA            | 200mA          |                |
|                                     | SCR/Relay     |   |                  | 300mA/1A         |                  | 300mA          |                |
| Output voltage drop DC/AC           |               | NPN PNP) 3V :3.9V AC 10V DC <3V AC <10V                 |                  |                  |                  |                |                |
| Consumption current                 |               | (NPN PNP) DC 12V 8mA 24V 15mA AC 10mA DC <15mA AC <10mA |                  |                  |                  |                |                |
| Standard detected object            |               | 20×20×1(A3 iron)  | 20×20×1(A3 iron) | 15×15×1(A3 iron) | 30×30×1(A3 iron) |                |                |
| Repeated precision                  |               | 0.02  | 0.03             | 0.03             | 0.05             |                |                |
| DC/AC                               |               | 400Hz/25Hz  | 300Hz            | 400Hz            | 200Hz/10Hz       |                |                |
| Working environment temperature     |               | -25°C~+75°C   | -25°C~+75°C      |                  | -25°C~+75°C      |                |                |
| Insulation resistance               |               | 50MΩ  | 50MΩ             |                  | 50MΩ             |                |                |
| Shell material                      |               | ABS Resin   | ABS Resin        | ABS Resin        | ABS Resin        |                |                |
| Protection grade                    |               | IP67  | IP67             |                  | IP67             |                |                |
| Alyemative model at home and abroad |               | PS17-5PN  | PS05-N PS05-P    |                  | TL-N5ME□□        |                |                |

# PROXIMITY SWITCH



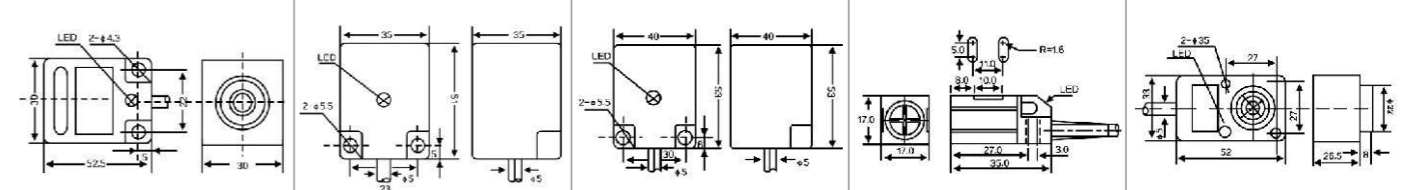

Angular column type

CZ LMF7 CZ LMF8 CZ LMF10 CZ LMF11 CZ LMF12





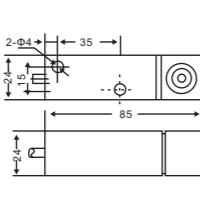
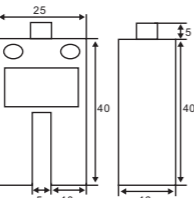
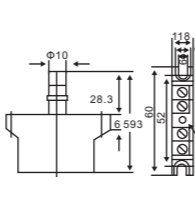
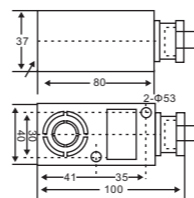

|                                     |               | DETECTION DISTANCE                                      |                  | 10mm             | 10mm             | 15mm             | 5mm             |                 |  |                 |
|-------------------------------------|---------------|---|------------------|------------------|------------------|------------------|-----------------|-----------------|--|-----------------|
| Flush                               | DC 10-30 VDC  | NPN   | NO               | CZ LMF7-3010NA   | CZ LMF8-3010NA   | CZ LMF10-3015NA  | CZ LMF11-3005NA |                 |  |                 |
|                                     |               |   | NC               | CZ LMF7-3010NB   | CZ LMF8-3010NB   | CZ LMF10-3015NB  | CZ LMF11-3005NB |                 |  |                 |
|                                     |               |   | NO+NC            | CZ LMF8-3010NC   | CZ LMF10-3015NC  | CZ LMF11-3005NC  |                 |                 |  |                 |
|                                     |               | PNP   | NO               | CZ LMF7-3010PA   | CZ LMF8-3010PA   | CZ LMF10-3015PA  | CZ LMF11-3005PA |                 |  |                 |
|                                     |               |   | NC               | CZ LMF7-3010PB   | CZ LMF8-3010PB   | CZ LMF10-3015PB  | CZ LMF11-3005PB |                 |  |                 |
|                                     |               |   | NO+NC            | CZ LMF8-3010PC   | CZ LMF10-3015PC  | CZ LMF11-3005PC  |                 |                 |  |                 |
|                                     | AC 90-250 VAC | two wire system   | NO               | CZ LMF7-3010LA   | CZ LMF8-3010LA   | CZ LMF10-3015LA  | CZ LMF11-3005LA |                 |  |                 |
|                                     |               |   | NC               | CZ LMF7-3010LB   | CZ LMF8-3010LB   | CZ LMF10-3015LB  | CZ LMF11-3005LB |                 |  |                 |
|                                     |               | SCR   | NO               |                  |                  | CZ LMF10-2015A   |                 |                 |  |                 |
|                                     |               |   | NC               |                  |                  | CZ LMF10-2015B   |                 |                 |  |                 |
| Relay output                        |               |   |                  |                  |                  |                  |                 |                 |  |                 |
| Non-Flush                           | DC 10-30 VDC  | NPN   | NO               |                  |                  | CZ LMF7-3015NA   | CZ LMF8-3015NA  | CZ LMF10-3020NA |  | CZ LMF12-3008NA |
|                                     |               |   | NC               |                  |                  | CZ LMF7-3015NB   | CZ LMF8-3015NB  | CZ LMF10-3020NB |  | CZ LMF12-3008NB |
|                                     |               |   | NO+NC            |                  |                  | CZ LMF7-3015NC   | CZ LMF8-3015NC  | CZ LMF10-3020NC |  | CZ LMF12-3008NC |
|                                     |               | PNP   | NO               |                  |                  | CZ LMF7-3015PA   | CZ LMF8-3015PA  | CZ LMF10-3020PA |  | CZ LMF12-3008PA |
|                                     |               |   | NC               |                  |                  | CZ LMF7-3015PB   | CZ LMF8-3015PB  | CZ LMF10-3020PB |  | CZ LMF12-3008PB |
|                                     |               |   | NO+NC            |                  |                  | CZ LMF7-3015PC   | CZ LMF8-3015PC  | CZ LMF10-3020PC |  | CZ LMF12-3008PC |
|                                     | AC 90-250 VAC | two wire system   | NO               |                  |                  | CZ LMF7-3015LA   | CZ LMF8-3015LA  | CZ LMF10-3020LA |  | CZ LMF12-3008LA |
|                                     |               |   | NC               |                  |                  | CZ LMF7-3015LB   | CZ LMF8-3015LB  | CZ LMF10-3020LB |  | CZ LMF12-3008LB |
|                                     |               | SCR   | NO               |                  |                  | CZ LMF7-2015A    | CZ LMF8-2015A   | CZ LMF10-2020A  |  | CZ LMF12-2008A  |
|                                     |               |   | NC               |                  |                  | CZ LMF7-2015B    | CZ LMF8-2015B   | CZ LMF10-2020B  |  | CZ LMF12-2008B  |
| Relay output                        |               |   |                  |                  |                  |                  |                 |                 |  |                 |
| Control output                      | DC            |   | 200mA            | 200mA            | 200mA            | 200mA            | 200mA           |                 |  |                 |
|                                     | SCR/Relay     |   |                  | 300mA            |                  | 500mA            |                 | 500mA           |  |                 |
| Output voltage drop DC/AC           |               | (NPN PNP) 3V :3.9V AC 10V DC <3V AC <10V                |                  |                  |                  |                  |                 |                 |  |                 |
| Consumption current                 |               | (NPN PNP) DC 12V 8mA 24V 15mA AC 10mA DC <15mA AC <10mA |                  |                  |                  |                  |                 |                 |  |                 |
| Standard detected object            |               | 35×35×1(A3 iron)  | 40×40×1(A3 iron) | 45×45×1(A3 iron) | 20×20×1(A3 iron) | 25×25×1(A3 iron) |                 |                 |  |                 |
| Repeated precision                  |               | 0.05  | 0.05             | 0.05             | 0.05             | 0.04             |                 |                 |  |                 |
| DC/AC                               |               | 200Hz/15Hz  | 200Hz/15Hz       | 100Hz/15Hz       | 500Hz            | 200Hz/15Hz       |                 |                 |  |                 |
| Working environment temperature     |               | -25°C~+75°C   | -25°C~+75°C      | -25°C~+70°C      | -25°C~+70°C      | -25°C~+70°C      |                 |                 |  |                 |
| Insulation resistance               |               | 50MΩ  | 50MΩ             | 50MΩ             | 50MΩ             | 50MΩ             |                 |                 |  |                 |
| Shell material                      |               | ABS Resin   | ABS Resin        | ABS Resin        | ABS Resin        | ABS Resin        |                 |                 |  |                 |
| Protection grade                    |               | IP67  | IP67             | IP67             | IP67             | IP67             |                 |                 |  |                 |
| Alyemative model at home and abroad |               | TL-N10M   |                  | TL-N20M□         | PL-05N PL-05P    | LJ1A-24          |                 |                 |  |                 |



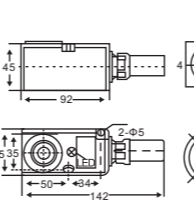
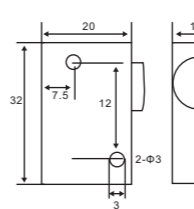
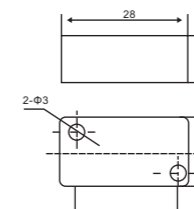
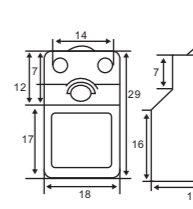
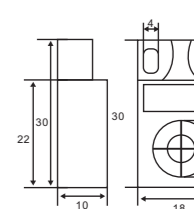

# PROXIMITY SWITCH

| Structural category                 |                 | Angular column type   |   |  |   |                 |                 |
|-------------------------------------|-----------------|---|---|--|---|-----------------|-----------------|
| Outward Appearance code             |                 | CZ LMF13  | CZ LMF14  | CZ LMF15   | CZ LMF16  |                 |                 |
| Outward appearance illustration     |                 |  |  |  |  |                 |                 |
| Overall dimensions                  |                 |  |  |  |  |                 |                 |
| DETECTION DISTANCE                  |                 | 2mm   |   |  |   |                 |                 |
| Flush                               | DC 10-30 VDC    | NPN   | NO  |  | CZ LMF15-3002NA   |                 |                 |
|                                     |                 |   | NC  |  | CZ LMF15-3002NB   |                 |                 |
|                                     |                 |   | NO+NC   |  | CZ LMF15-3002NC   |                 |                 |
|                                     |                 | PNP   | NO  |  | CZ LMF15-3002PA   |                 |                 |
|                                     |                 |   | NC  |  | CZ LMF15-3002PB   |                 |                 |
|                                     |                 |   | NO+NC   |  | CZ LMF15-3002PC   |                 |                 |
|                                     | two wire system | NO  |   | CZ LMF15-3002LA  |   |                 |                 |
|                                     |                 | NC  |   | CZ LMF15-3002LB  |   |                 |                 |
|                                     | AC 90-250 VAC   | SCR   | NO  |  | CZ LMF15-2002A  |                 |                 |
|                                     |                 | Control-silicon   | NC  |  | CZ LMF15-2002B  |                 |                 |
| Relay output                        |                 |   |   |  |   |                 |                 |
| DETECTION DISTANCE                  |                 | 8mm   | 5mm   | 4mm  | 15mm  |                 |                 |
| Non-Flush                           | DC 10-30 VDC    | NPN   | NO  | CZ LMF13-3008NA  | CZ LMF14-3005NA   | CZ LMF15-3004NA | CZ LMF16-3015NA |
|                                     |                 |   | NC  | CZ LMF13-3008NB  | CZ LMF14-3005NB   | CZ LMF15-3004NB | CZ LMF16-3015NB |
|                                     |                 |   | NO+NC   | CZ LMF13-3008NC  | CZ LMF14-3005NC   | CZ LMF15-3004NC | CZ LMF16-3015NC |
|                                     |                 | PNP   | NO  | CZ LMF13-3008PA  | CZ LMF14-3005PA   | CZ LMF15-3004PA | CZ LMF16-3015PA |
|                                     |                 |   | NC  | CZ LMF13-3008PB  | CZ LMF14-3005PB   | CZ LMF15-3004PB | CZ LMF16-3015PB |
|                                     |                 |   | NO+NC   | CZ LMF13-3008PC  | CZ LMF14-3005PC   | CZ LMF15-3004PC | CZ LMF16-3015PC |
|                                     | two wire system | NO  | CZ LMF13-3008LA   | CZ LMF14-3005LA  | CZ LMF15-3004LA   | CZ LMF16-3015LA |                 |
|                                     |                 | NC  | CZ LMF13-3008LB   | CZ LMF14-3005LB  | CZ LMF15-3004LB   | CZ LMF16-3015LB |                 |
|                                     | AC 90-250 VAC   | SCR   | NO  | CZ LMF13-2008A   | CZ LMF14-2005A  | CZ LMF15-2004A  | CZ LMF16-2015A  |
|                                     |                 | Control-silicon   | NC  | CZ LMF13-2008B   | CZ LMF14-2005B  | CZ LMF15-2004B  | CZ LMF16-2015B  |
| Relay output                        |                 |   |   |  | CZ LMF16-2015C  |                 |                 |
| Controloutput                       | DC              | 200mA   | 200mA   | 200mA  | 200mA   |                 |                 |
|                                     | SCR/Relay       | 300mA/1A  |   |  |   |                 |                 |
| Output voltage drop DC/AC           |                 | (NPN PNP) 3V以下、二线型:3.9V以下、交流AC 10V以下 DC<3V、 AC<10V                                |   |  |   |                 |                 |
| Consumption current                 |                 | 直流(NPN PNP)型DC 12V时8mA、24V时15mA、交流AC 10mA以下 DC<15mA、AC<10mA                       |   |  |   |                 |                 |
| Standard detected object            |                 | 25×25×1(A3铁iron)  | 18×18×1(A3铁iron)  | 15×15×1(A3铁iron)   | 45×45×1(A3铁iron)  |                 |                 |
| Repeated precision                  |                 | 0.04  | 0.05  | 0.02   | 0.05  |                 |                 |
| DC/AC                               |                 | 200Hz/15Hz  | 500Hz/10Hz  |  | 100Hz/Hz  |                 |                 |
| Working environment temperature     |                 | -25°C~+70°C   |   |  |   |                 |                 |
| Insulation resistance               |                 | 50MΩ  |   |  |   |                 |                 |
| Shell material                      |                 | ABS树脂 Resin   | ABS塑料 Plastil   |  |   |                 |                 |
| Protection grade                    |                 | IP67  | IP67  |  |   |                 |                 |
| Alyemative model at home and abroad |                 | LJD-□□  |   | ST-F-□   | LJ2-□□/□□□  |                 |                 |



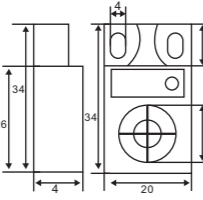
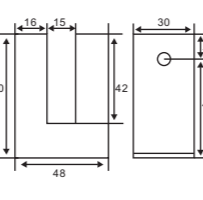
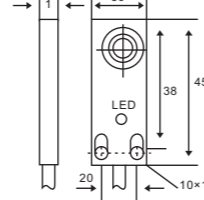
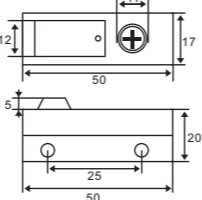

# PROXIMITY SWITCH

| Angular column type             |                 | Plane installation type   |   |   |   |   |                 |                 |
|---------------------------------|-----------------|---|---|---|---|---|-----------------|-----------------|
| Outward Appearance code         |                 | CZ LMF17  | CZ LMF21  | CZ LMF22  | CZ LMF23  | CZ LMF24  |                 |                 |
| Outward appearance illustration |                 |  |  |  |  |  |                 |                 |
| Overall dimensions              |                 |  |  |  |  |  |                 |                 |
| DETECTION DISTANCE              |                 | 4mm   | 2mm   | 4mm   | 4mm   | 4mm   |                 |                 |
| Flush                           | DC 10-30 VDC    | NPN   | NO  |   | CZ LMF22-3002NA   |   |                 |                 |
|                                 |                 |   | NC  |   | CZ LMF22-3002NB   |   |                 |                 |
|                                 |                 |   | NO+NC   |   |   |   |                 |                 |
|                                 |                 | PNP   | NO  |   | CZ LMF22-3002PA   |   |                 |                 |
|                                 |                 |   | NC  |   | CZ LMF22-3002PB   |   |                 |                 |
|                                 |                 |   | NO+NC   |   |   |   |                 |                 |
|                                 | two wire system | NO  |   | CZ LMF22-3002LA   |   |   |                 |                 |
|                                 |                 | NC  |   | CZ LMF22-3002LB   |   |   |                 |                 |
|                                 | AC 90-250 VAC   | SCR   | NO  |   |   |   |                 |                 |
|                                 |                 | Control-silicon   | NC  |   |   |   |                 |                 |
| Relay output                    |                 |   |   |   |   |   |                 |                 |
| DETECTION DISTANCE              |                 | 20mm  | 4mm   | 4mm   | 5mm   | 5mm   |                 |                 |
| Non-Flush                       | DC 10-30 VDC    | NPN   | NO  | CZ LMF17-3020NA   | CZ LMF21-3004NA   | CZ LMF22-3004NA   | CZ LMF23-3005NA | CZ LMF24-3005NA |
|                                 |                 |   | NC  | CZ LMF17-3020NB   | CZ LMF21-3004NB   | CZ LMF22-3004NB   | CZ LMF23-3005NB | CZ LMF24-3005NB |
|                                 |                 |   | NO+NC   | CZ LMF17-3020NC   | CZ LMF21-3004NC   | CZ LMF22-3004NC   | CZ LMF23-3005NC | CZ LMF24-3005NC |
|                                 |                 | PNP   | NO  | CZ LMF17-3020PA   | CZ LMF21-3004PA   | CZ LMF22-3004PA   | CZ LMF23-3005PA | CZ LMF24-3005PA |
|                                 |                 |   | NC  | CZ LMF17-3020PB   | CZ LMF21-3004PB   | CZ LMF22-3004PB   | CZ LMF23-3005PB | CZ LMF24-3005PB |
|                                 |                 |   | NO+NC   | CZ LMF17-3020PC   | CZ LMF21-3004PC   | CZ LMF22-3004PC   | CZ LMF23-3005PC | CZ LMF24-3005PC |
|                                 | two wire system | NO  | CZ LMF17-3020LA   | CZ LMF21-3004LA   | CZ LMF22-3004LA   | CZ LMF23-3005LA   | CZ LMF24-3005LA |                 |
|                                 |                 | NC  | CZ LMF17-3020LB   | CZ LMF21-3004LB   | CZ LMF22-3004LB   | CZ LMF23-3005LB   | CZ LMF24-3005LB |                 |
|                                 | AC 90-250 VAC   | SCR   | NO  | CZ LMF17-2020A  |   |   |                 |                 |
|                                 |                 | Control-silicon   | NC  | CZ LMF17-2020B  |   |   |                 |                 |
| Relay output                    |                 | CZ LMF17-2020C  |   |   |   |   |                 |                 |
| Controloutput                   |                 | 200mA   | 200mA   | 200mA   | 200mA   | 200mA   |                 |                 |
| Output voltage drop DC/AC       |                 | (NPN PNP) 3V :3.9V AC 10V DC<3V AC <10V   |   |   |   |   |                 |                 |
| Consumption current             |                 | (NPN PNP) DC 12V 8mA 24V 15mA AC 10mA DC<15mA AC<10mA                               |   |   |   |   |                 |                 |
| Standard detected object        |                 | 50×50×1(A3 iron)  | 12×12×1(A3 iron)  | 15×15×1(A3 iron)  | 20×20×1(A3 iron)  | 12×12×1(A3 iron)  |                 |                 |
| Repeated precision              |                 | 0.2   | 0.01  | 0.05  | 0.05  | 0.05  |                 |                 |
| DC/AC                           |                 | 200Hz/15Hz  | 500Hz/5Hz   | 300Hz   | 500Hz   | 500Hz/5Hz   |                 |                 |
| Working environment temperature |                 | -25°C~+70°C   |   |   |   |   |                 |                 |
| Insulation resistance           |                 | ≥50MΩ   | 50MΩ  | ≥50MΩ   | 50MΩ  | 50MΩ  |                 |                 |
| Shell material                  |                 | ABS Resin   |   | ABS Resin   | ABS Plastil   | ABS Plastil   |                 |                 |
| Protection grade                |                 | IP67  | IP67  | IP67  | IP67  | IP67  |                 |                 |

# PROXIMITY SWITCH

| Structural category                 |                 | Plane installation type   |   | Angular column type  |   |                 |                 |                |
|-------------------------------------|-----------------|---|---|--|---|-----------------|-----------------|----------------|
| Outward Appearance code             |                 | CZ LMF25  | CZ LMF27  | CZ LMF29   | CZ LMF30  |                 |                 |                |
| Outward appearance illustration     |                 |  |  |  |  |                 |                 |                |
| Overall dimensions                  |                 |  |  |  |  |                 |                 |                |
| DETECTION DISTANCE                  |                 | 5mm   |   |  |   |                 |                 |                |
| Flush                               | DC 10-30 VDC    | NPN   | NO  |  | CZ LMF29-3005NA   |                 |                 |                |
|                                     |                 |   | NC  |  | CZ LMF29-3005NB   |                 |                 |                |
|                                     |                 |   | NO+NC   |  | CZ LMF29-3005NC   |                 |                 |                |
|                                     |                 | PNP   | NO  |  | CZ LMF29-3005PA   |                 |                 |                |
|                                     |                 |   | NC  |  | CZ LMF29-3005PB   |                 |                 |                |
|                                     |                 |   | NO+NC   |  | CZ LMF29-3005PC   |                 |                 |                |
|                                     | two wire system | NO  |   | CZ LMF29-3005LA  |   |                 |                 |                |
|                                     | NC              |   |   |  |   |                 |                 |                |
|                                     | AC 90-250 VAC   | SCR   | NO  |  | CZ LMF29-2005A  |                 |                 |                |
|                                     |                 | Control-silicon   | NC  |  | CZ LMF29-2005B  |                 |                 |                |
| NO+NC                               |                 |   |   |  |   |                 |                 |                |
| Relay output                        |                 |   |   |  |   |                 |                 |                |
| DETECTION DISTANCE                  |                 | 5mm   | 15mm  | 8mm  | 4mm   |                 |                 |                |
| Non-Flush                           | DC 10-30 VDC    | NPN   | NO  | CZ LMF25-3005NA  | CZ LMF27-3015NA   | CZ LMF29-3008NA | CZ LMF30-3004NA |                |
|                                     |                 |   | NC  | CZ LMF25-3005NB  | CZ LMF27-3015NB   | CZ LMF29-3008NB | CZ LMF30-3004NB |                |
|                                     |                 |   | NO+NC   | CZ LMF25-3005NC  | CZ LMF27-3015NC   | CZ LMF29-3008NC | CZ LMF30-3004NC |                |
|                                     |                 | PNP   | NO  | CZ LMF25-3005PA  | CZ LMF27-3015PA   | CZ LMF29-3008PA | CZ LMF30-3004PA |                |
|                                     |                 |   | NC  | CZ LMF25-3005PB  | CZ LMF27-3015PB   | CZ LMF29-3008PB | CZ LMF30-3004PB |                |
|                                     |                 |   | NO+NC   | CZ LMF25-3005PC  | CZ LMF27-3015PC   | CZ LMF29-3008PC | CZ LMF30-3004PC |                |
|                                     |                 | two wire system   | NO  | CZ LMF25-3005LA  | CZ LMF27-3015LA   | CZ LMF29-3008LA | CZ LMF30-3004LA |                |
|                                     |                 | NC  | CZ LMF25-3005LB   |  | CZ LMF29-3008LB   |                 |                 |                |
|                                     |                 | AC 90-250 VAC   | SCR   | NO   | CZ LMF25-2005A  | CZ LMF27-2015A  | CZ LMF29-2008A  | CZ LMF30-2004A |
|                                     |                 |   | Control-silicon   | NC   | CZ LMF25-2005B  | CZ LMF27-2015B  | CZ LMF29-2008B  | CZ LMF30-2004B |
|                                     | NO+NC           |   |   |  |   |                 |                 |                |
|                                     | Relay output    |   |   |  |   |                 |                 |                |
|                                     | Control output  | DC  | 200mA   | 200mA  | 200mA   | 200mA           |                 |                |
|                                     |                 | SCR/Relay   | 500mA   | 300mA  | 300mA   | 300mA           |                 |                |
| Output voltage drop DC/AC           |                 | (NPN PNP) 3V :3.9V AC 10V DC<3V AC < 10V  |   |  |   |                 |                 |                |
| Consumption current                 |                 | (NPN PNP) DC 12V 8mA 24V 15mA AC 10mA DC<15mA AC<10mA                             |   |  |   |                 |                 |                |
| Standard detected object            |                 | 18×18×1(A3 iron)  | 30×30×1(A3 iron)  | 25×25×1(A3 iron)   | 15×15×1(A3 iron)  |                 |                 |                |
| Repeated precision                  |                 | 0.05  | 0.05  | 0.05   | 0.05  |                 |                 |                |
| DC/AC                               |                 | 500Hz/10Hz  | 300Hz/10Hz  | 300Hz  | 300Hz/10Hz  |                 |                 |                |
| Working environment temperature     |                 | -25°C~+70°C   | -25°C~+70°C   | -25°C~+70°C  | -25°C~+70°C   |                 |                 |                |
| Insulation resistance               |                 | 50MΩ  | 50MΩ  | 50MΩ   | 50MΩ  |                 |                 |                |
| Shell material                      |                 | ABS Plastil   |   | ABS Resin  |   |                 |                 |                |
| Protection grade                    |                 | IP67  | IP67  | IP67   | IP67  |                 |                 |                |
| Alyemative model at home and abroad |                 |   |   |  |   |                 |                 |                |

# PROXIMITY SWITCH

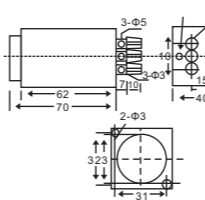
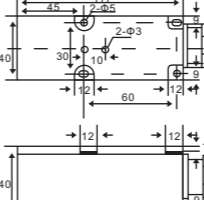
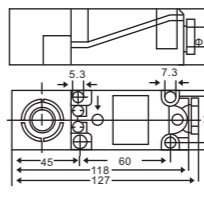
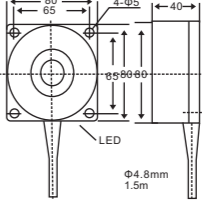
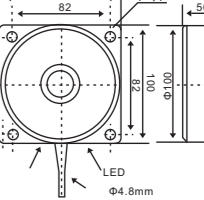
| Angular column type                 |                 | Plane installation type   |   |   |   |   |                 |                 |                |
|-------------------------------------|-----------------|---|---|---|---|---|-----------------|-----------------|----------------|
| Outward Appearance code             |                 | CZ LMF35  | CZ LMF36  | CZ LMF37  | CZ LMF38  | CZ LMF39  |                 |                 |                |
| Outward appearance illustration     |                 |  |  |  |  |  |                 |                 |                |
| Overall dimensions                  |                 |  |  |  |  |  |                 |                 |                |
| DETECTION DISTANCE                  |                 | 15mm  |   |   |   |   |                 |                 |                |
| Flush                               | DC 10-30 VDC    | NPN   | NO  |   | CZ LMF37-3015NA   |   |                 |                 |                |
|                                     |                 |   | NC  |   | CZ LMF37-3015NB   |   |                 |                 |                |
|                                     |                 |   | NO+NC   |   | CZ LMF37-3015NC   |   |                 |                 |                |
|                                     |                 | PNP   | NO  |   | CZ LMF37-3015PA   |   |                 |                 |                |
|                                     |                 |   | NC  |   | CZ LMF37-3015PB   |   |                 |                 |                |
|                                     |                 |   | NO+NC   |   | CZ LMF37-3015PC   |   |                 |                 |                |
|                                     | two wire system | NO  |   | CZ LMF37-3015LA   |   |   |                 |                 |                |
|                                     | NC              |   |   |   |   |   |                 |                 |                |
|                                     | AC 90-250 VAC   | SCR   | NO  |   | CZ LMF37-2015A  |   |                 |                 |                |
|                                     |                 | Control-silicon   | NC  |   | CZ LMF37-2015B  |   |                 |                 |                |
| NO+NC                               |                 |   |   |   | CZ LMF37-2015C  |   |                 |                 |                |
| Relay output                        |                 |   |   |   |   |   |                 |                 |                |
| DETECTION DISTANCE                  |                 | 15mm  | 1-20mm  | 20mm  | 1-40mm  | 1-50mm  |                 |                 |                |
| Non-Flush                           | DC 10-30 VDC    | NPN   | NO  | CZ LMF35-3015NA   | CZ LMF36-3020NA   | CZ LMF37-3020NA   | CZ LMF38-3040NA | CZ LMF39-3050NA |                |
|                                     |                 |   | NC  | CZ LMF35-3015NB   | CZ LMF36-3020NB   | CZ LMF37-3020NB   | CZ LMF38-3040NB | CZ LMF39-3050NB |                |
|                                     |                 |   | NO+NC   | CZ LMF35-3015NC   | CZ LMF36-3020NC   | CZ LMF37-3020NC   | CZ LMF38-3040NC | CZ LMF39-3050NC |                |
|                                     |                 | PNP   | NO  | CZ LMF35-3015PA   | CZ LMF36-3020PA   | CZ LMF37-3020PA   | CZ LMF38-3040PA | CZ LMF39-3050PA |                |
|                                     |                 |   | NC  | CZ LMF35-3015PB   | CZ LMF36-3020PB   | CZ LMF37-3020PB   | CZ LMF38-3040PB | CZ LMF39-3050PB |                |
|                                     |                 |   | NO+NC   | CZ LMF35-3015PC   | CZ LMF36-3020PC   | CZ LMF37-3020PC   | CZ LMF38-3040PC | CZ LMF39-3050PC |                |
|                                     |                 | two wire system   | NO  | CZ LMF35-3015LA   | CZ LMF36-3020LA   | CZ LMF37-3020LA   | CZ LMF38-3040LA | CZ LMF39-3050LA |                |
|                                     |                 | NC  | CZ LMF35-3015LB   | CZ LMF36-3020LB   | CZ LMF37-3020LB   | CZ LMF38-3040LB   | CZ LMF39-3050LB |                 |                |
|                                     |                 | AC 90-250 VAC   | SCR   | NO  | CZ LMF35-2015A  | CZ LMF36-2020A  | CZ LMF37-2020A  | CZ LMF38-2040A  | CZ LMF39-2050A |
|                                     |                 |   | Control-silicon   | NC  | CZ LMF35-2015B  | CZ LMF36-2020B  | CZ LMF37-2020B  | CZ LMF38-2040B  | CZ LMF39-2050B |
|                                     | NO+NC           |   |   |   |   |   |                 |                 |                |
|                                     | Relay output    |   |   |   |   |   |                 |                 |                |
|                                     | Control output  | DC  | 200mA   | 200mA   | 200mA   | 200mA   | 200mA           |                 |                |
|                                     |                 | SCR/Relay   | 500mA   | 300mA/2A  | 300mA/2A  | 300mA/2A  | 300mA/2A        |                 |                |
| Output voltage drop DC/AC           |                 | (NPN PNP) 3V :3.9V AC 10V DC<3V AC < 10V  |   |   |   |   |                 |                 |                |
| Consumption current                 |                 | (NPN PNP) DC 12V 8mA 24V 15mA AC 10mA DC<15mA AC<10mA                               |   |   |   |   |                 |                 |                |
| Standard detected object            |                 | 40×40×1(A3 iron)  | 50×50×1(A3 iron)  | 50×50×1(A3 iron)  | 100×100×1(A3 iron)  | 120×120×1(A3 iron)  |                 |                 |                |
| Repeated precision                  |                 | 0.05  | 0.2   | 0.2   | 0.5   | 0.5   |                 |                 |                |
| DC/AC                               |                 | 200Hz/15Hz  | 500Hz/15Hz  | 200Hz/15Hz  | 50Hz/10Hz   | 50Hz/10Hz   |                 |                 |                |
| Working environment temperature     |                 | -25°C~+70°C   | -25°C~+70°C   | -25°C~+70°C   | -25°C~+75°C   | -25°C~+75°C   |                 |                 |                |
| Insulation resistance               |                 | ≥50MΩ   | 50MΩ  | ≥50MΩ   | 50MΩ  | 50MΩ  |                 |                 |                |
| Shell material                      |                 | ABS Resin   | ABS Resin   | ABS Resin   |   |   |                 |                 |                |
| Protection grade                    |                 | IP67  | IP67  | IP67  | IP67  | IP67  |                 |                 |                |
| Alyemative model at home and abroad |                 | JDK-2正負   |   | HY-A20□   | TCD-2040□   | TCD-2050□   |                 |                 |                |

# PROXIMITY SWITCH

Structural category Plane installation type

Outward Appearance code CZ LMF40 CZ LMF41 CZ LMF42 CZ LMF43

Outward appearance illustration

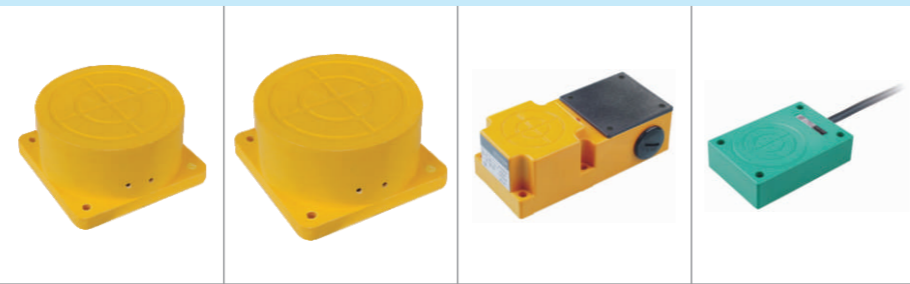

Overall dimensions

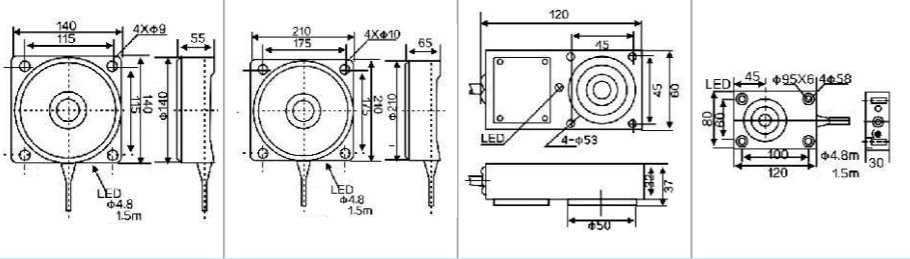

|                                     |                           | DETECTION DISTANCE    |   |                  |                    |                 |                 |
|-------------------------------------|---------------------------|-----------------------|---|------------------|--------------------|-----------------|-----------------|
| Flush                               | DC 10-30 VDC              | NPN                   | NO  |                  |                    |                 |                 |
|                                     |                           |                       | NC  |                  |                    |                 |                 |
|                                     |                           |                       | NO+NC   |                  |                    |                 |                 |
|                                     |                           | PNP                   | NO  |                  |                    |                 |                 |
|                                     |                           |                       | NC  |                  |                    |                 |                 |
|                                     | two wire system           | NO                    |   |                  |                    |                 |                 |
|                                     |                           | NC                    |   |                  |                    |                 |                 |
|                                     | AC 90-250 VAC             | SCR                   | NO  |                  |                    |                 |                 |
|                                     |                           | Control-lable silicon | NC  |                  |                    |                 |                 |
|                                     |                           |                       | NO+NC   |                  |                    |                 |                 |
| Relay output                        |                           |                       |   |                  |                    |                 |                 |
|                                     |                           | DETECTION DISTANCE    |   |                  |                    |                 |                 |
| Non-Flush                           | DC 10-30 VDC              | NPN                   | NO  | CZ LMF40-3080NA  | CZ LMF41-30120NA   | CZ LMF42-3025NA | CZ LMF43-3040NA |
|                                     |                           |                       | NC  | CZ LMF40-3080NB  | CZ LMF41-30120NB   | CZ LMF42-3025NB | CZ LMF43-3040NB |
|                                     |                           |                       | NO+NC   | CZ LMF40-3080NC  | CZ LMF41-30120NC   | CZ LMF42-3025NC | CZ LMF43-3040NC |
|                                     |                           | PNP                   | NO  | CZ LMF40-3080PA  | CZ LMF41-30120PA   | CZ LMF42-3025PA | CZ LMF43-3040PA |
|                                     |                           |                       | NC  | CZ LMF40-3080PB  | CZ LMF41-30120PB   | CZ LMF42-3025PB | CZ LMF43-3040PB |
|                                     | two wire system           | NO+NC                 | CZ LMF40-3080PC                                       | CZ LMF41-30120PC | CZ LMF42-3025PC    | CZ LMF43-3040PC |                 |
|                                     |                           | NO                    | CZ LMF40-3080LA                                       | CZ LMF41-30120LA | CZ LMF42-3025LA    | CZ LMF43-3040LA |                 |
|                                     | AC 90-250 VAC             | SCR                   | NO  | CZ LMF40-3080LB  | CZ LMF41-30120LB   | CZ LMF42-3025LB | CZ LMF43-3040LB |
|                                     |                           | Control-lable silicon | NC  | CZ LMF40-2080A   | CZ LMF41-20120A    | CZ LMF42-2025A  | CZ LMF43-2040A  |
|                                     |                           |                       | NO+NC   | CZ LMF40-2080B   | CZ LMF41-20120B    | CZ LMF42-2025B  | CZ LMF43-2040B  |
|                                     | Relay output              |                       |   | CZ LMF40-2080C   | CZ LMF41-20120C    | CZ LMF42-2025C  | CZ LMF43-2040C  |
|                                     | Control output            | DC                    |   | 200mA            | 200mA              | 200mA           | 200mA           |
|                                     |                           | SCR/ Relay            |   | 300mA/3A         | 300mA/5A           | 300mA/2A        | 300mA/2A        |
|                                     | Output voltage drop DC/AC |                       | (NPN PNP) 3V :3.9V AC 10V DC<3V AC <10V               |                  |                    |                 |                 |
|                                     | Consumption current       |                       | (NPN PNP) DC 12V 8mA 24V 15mA AC 10mA DC<15mA AC<10mA |                  |                    |                 |                 |
| Standard detected object            |                           | 160×160×1(A3 iron)    | 250×250×1(A3 iron)                                    | 80×80×1(A3 iron) | 100×100×1(A3 iron) |                 |                 |
| Repeated precision                  |                           | 0.5                   | 0.5   | 0.05             | 0.05               |                 |                 |
| DC/AC                               |                           | 10Hz/5Hz              | 10Hz/5Hz  | 50Hz/10Hz        | 30Hz/10Hz          |                 |                 |
| Working environment temperature     |                           | -25°C~+75°C           | -25°C~+75°C   | -25°C~+70°C      | -25°C~+70°C        |                 |                 |
| Insulation resistance               |                           | 50MΩ                  | 50MΩ  | 50MΩ             | 50MΩ               |                 |                 |
| Shell material                      |                           |                       |   | ABS Resin        | ABS Resin          |                 |                 |
| Protection grade                    |                           | IP67                  | IP67  | IP65             | IP65               |                 |                 |
| Alyemative model at home and abroad |                           | TCB-2080□             | TCC-2120□   |                  |                    |                 |                 |

# PROXIMITY SWITCH

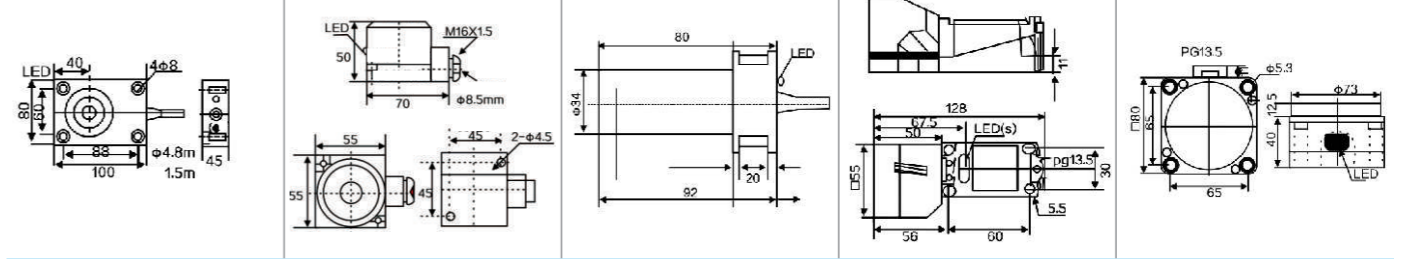

Plane installation type

CZ LMF45 CZ LMF55 CZ LMF340 CZ LMF370 CZ LMF380



|                                     |                           | DETECTION DISTANCE    |   |                  |                  |                  |                  |                  |
|-------------------------------------|---------------------------|-----------------------|---|------------------|------------------|------------------|------------------|------------------|
| Flush                               | DC 10-30 VDC              | NPN                   | NO  |                  |                  |                  |                  |                  |
|                                     |                           |                       | NC  |                  |                  |                  |                  |                  |
|                                     |                           |                       | NO+NC   |                  |                  |                  |                  |                  |
|                                     |                           | PNP                   | NO  |                  |                  |                  |                  |                  |
|                                     |                           |                       | NC  |                  |                  |                  |                  |                  |
|                                     | two wire system           | NO                    |   |                  |                  |                  |                  |                  |
|                                     |                           | NC                    |   |                  |                  |                  |                  |                  |
|                                     | AC 90-250 VAC             | SCR                   | NO  |                  |                  |                  |                  |                  |
|                                     |                           | Control-lable silicon | NC  |                  |                  |                  |                  |                  |
|                                     |                           |                       | NO+NC   |                  |                  |                  |                  |                  |
| Relay output                        |                           |                       |   |                  |                  |                  |                  |                  |
|                                     |                           | DETECTION DISTANCE    |   |                  |                  |                  |                  |                  |
| Non-Flush                           | DC 10-30 VDC              | NPN                   | NO  | CZ LMF45-3050NA  | CZ LMF55-3025NA  | CZ LMF340-3020NA | CZ LMF370-3040NA | CZ LMF380-3040NA |
|                                     |                           |                       | NC  | CZ LMF45-3050NB  | CZ LMF55-3025NB  | CZ LMF340-3020NB | CZ LMF370-3040NB | CZ LMF380-3040NB |
|                                     |                           |                       | NO+NC   | CZ LMF45-3050NC  | CZ LMF55-3025NC  | CZ LMF340-3020NC | CZ LMF370-3040NC | CZ LMF380-3040NC |
|                                     |                           | PNP                   | NO  | CZ LMF45-3050PA  | CZ LMF55-3025PA  | CZ LMF340-3020PA | CZ LMF370-3040PA | CZ LMF380-3040PA |
|                                     |                           |                       | NC  | CZ LMF45-3050PB  | CZ LMF55-3025PB  | CZ LMF340-3020PB | CZ LMF370-3040PB | CZ LMF380-3040PB |
|                                     | two wire system           | NO+NC                 | CZ LMF45-3050PC                                       | CZ LMF55-3025PC  | CZ LMF340-3020PC | CZ LMF370-3040PC | CZ LMF380-3040PC |                  |
|                                     |                           | NO                    | CZ LMF45-3050LA                                       | CZ LMF55-3025LA  | CZ LMF340-3020LA | CZ LMF370-3040LA | CZ LMF380-3040LA |                  |
|                                     | AC 90-250 VAC             | SCR                   | NO  | CZ LMF45-3050LB  | CZ LMF55-3025LB  | CZ LMF340-3020LB | CZ LMF370-3040LB | CZ LMF380-3040LB |
|                                     |                           | Control-lable silicon | NC  | CZ LMF45-2050A   | CZ LMF55-2025A   | CZ LMF340-2020A  | CZ LMF370-2040A  | CZ LMF380-2040A  |
|                                     |                           |                       | NO+NC   | CZ LMF45-2050B   | CZ LMF55-2025B   | CZ LMF340-2020B  | CZ LMF370-2040B  | CZ LMF380-2040B  |
|                                     | Relay output              |                       |   | CZ LMF45-2050C   | CZ LMF55-2025C   | CZ LMF340-2020C  | CZ LMF370-2040C  | CZ LMF380-2040C  |
|                                     | Control output            | DC                    |   | 200mA            | 200mA            | 200mA            | 200mA            | 200mA            |
|                                     |                           | SCR/ Relay            |   | 500mA            | 300mA/2A         | 300mA            | 500mA            | 500mA            |
|                                     | Output voltage drop DC/AC |                       | (NPN PNP) 3V :3.9V AC 10V DC<3V AC <10V               |                  |                  |                  |                  |                  |
|                                     | Consumption current       |                       | (NPN PNP) DC 12V 8mA 24V 15mA AC 10mA DC<15mA AC<10mA |                  |                  |                  |                  |                  |
| Standard detected object            |                           | 80×80×1(A3 iron)      | 70×70×1(A3 iron)                                      | 35×35×1(A3 iron) | 55×55×1(A3 iron) | 50×50×1(A3 iron) |                  |                  |
| Repeated precision                  |                           | 0.5                   | 0.2   | 0.05             | 0.5              | 0.05             |                  |                  |
| DC/AC                               |                           | 200Hz/5Hz             | 200Hz/10Hz  | 300Hz/10Hz       | 200Hz/10Hz       | 500Hz/10Hz       |                  |                  |
| Working environment temperature     |                           | -25°C~+70°C           | -25°C~+70°C   | -25°C~+70°C      | -25°C~+70°C      | -25°C~+70°C      |                  |                  |
| Insulation resistance               |                           | 50MΩ                  | 50MΩ  | 50MΩ             | 50MΩ             | 50MΩ             |                  |                  |
| Shell material                      |                           | Plastil               | ABS Resin   |                  | Plastil          | ABC Plastil      |                  |                  |
| Protection grade                    |                           | IP67                  | IP67  | IP67             | IP67             | IP67             |                  |                  |
| Alyemative model at home and abroad |                           |                       | HE-/HD-   |                  |                  | NJ40P-FP-A2-P1   |                  |                  |

# STRAIGHT CONNECTOR SWITCH

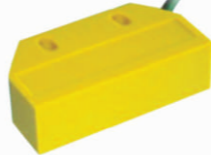
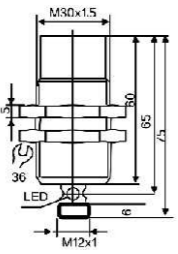
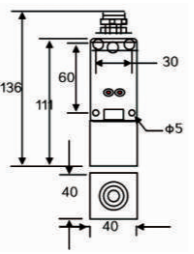
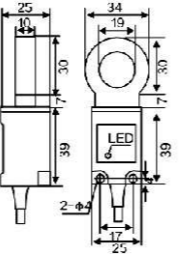
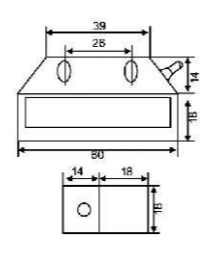
| Structural category                 |                 | Connector type  |   |  |   |                 |                 |                |
|-------------------------------------|-----------------|---|---|--|---|-----------------|-----------------|----------------|
| Outward Appearance code             |                 | CZ LM30-□T/LM30-□T3   | CZ LMF31  | CZ LMF32   | CZ LMF33  |                 |                 |                |
| Outward appearance illustration     |                 |  |  |  |  |                 |                 |                |
| Overall dimensions                  |                 |  |  |  |  |                 |                 |                |
| DETECTION DISTANCE                  |                 | 10mm  | 15mm  | 20mm   | 5mm   |                 |                 |                |
| Flush                               | DC 6-36 VDC     | NPN   | NO  | CZ LM30-3010NAT  | CZ LMF31-3015NA   | CZ LMF32-3020NA | CZ LMF33-3005NA |                |
|                                     |                 |   | NC  | CZ LM30-3010NBT  | CZ LMF31-3015NB   | CZ LMF32-3020NB | CZ LMF33-3005NB |                |
|                                     |                 |   | NO+NC   | CZ LM30-3010NCT  | CZ LMF31-3015NC   | CZ LMF32-3020NC | CZ LMF33-3005NC |                |
|                                     |                 | PNP   | NO  | CZ LM30-3010PAT  | CZ LMF31-3015PA   | CZ LMF32-3020PA | CZ LMF33-3005PA |                |
|                                     |                 |   | NC  | CZ LM30-3010PBT  | CZ LMF31-3015PB   | CZ LMF32-3020PB | CZ LMF33-3005PB |                |
|                                     | two wire system | NO+NC   | CZ LM30-3010PCT   | CZ LMF31-3015PC  | CZ LMF32-3020PC   | CZ LMF33-3005PC |                 |                |
|                                     |                 | NO  | CZ LM30-3010LAT   | CZ LMF31-3015LA  | CZ LMF32-3020LA   | CZ LMF33-3005LA |                 |                |
|                                     |                 | NC  | CZ LM30-3010LBT   | CZ LMF31-3015LB  | CZ LMF32-3020LB   | CZ LMF33-3005LB |                 |                |
|                                     |                 | AC 90-250 VAC   | SCR   | NO   | CZ LM30-2010AT  | CZ LMF31-2015A  | CZ LMF32-2020A  | CZ LMF33-2005A |
|                                     |                 |   | Control-silicon   | NC   | CZ LM30-2010BT  | CZ LMF31-2015B  | CZ LMF32-2020B  | CZ LMF33-2005B |
| Relay output                        |                 |   |   |  |   |                 |                 |                |
| DETECTION DISTANCE                  |                 | 15mm  | 20mm  |  | 8mm   |                 |                 |                |
| Non-Flush                           | DC 10-30 VDC    | NPN   | NO  | CZ LM30-3015NAT  | CZ LMF31-3020NA   |                 | CZ LMF33-3008NA |                |
|                                     |                 |   | NC  | CZ LM30-3015NBT  | CZ LMF31-3020NB   |                 | CZ LMF33-3008NB |                |
|                                     |                 |   | NO+NC   | CZ LM30-3015NCT  | CZ LMF31-3020NC   |                 | CZ LMF33-3008NC |                |
|                                     |                 | PNP   | NO  | CZ LM30-3015PAT  | CZ LMF31-3020PA   |                 | CZ LMF33-3008PA |                |
|                                     |                 |   | NC  | CZ LM30-3015PBT  | CZ LMF31-3020PB   |                 | CZ LMF33-3008PB |                |
|                                     | two wire system | NO+NC   | CZ LM30-3015PCT   | CZ LMF31-3020PC  |   | CZ LMF33-3008PC |                 |                |
|                                     |                 | NO  | CZ LM30-3015LAT   | CZ LMF31-3020LA  |   | CZ LMF33-3008LA |                 |                |
|                                     |                 | NC  | CZ LM30-3015LBT   | CZ LMF31-3020LB  |   | CZ LMF33-3008LB |                 |                |
|                                     |                 | AC 90-250 VAC   | SCR   | NO   | CZ LM30-2015AT  | CZ LMF31-2020A  |                 | CZ LMF33-2008A |
|                                     |                 |   | Control-silicon   | NC   | CZ LM30-2015BT  | CZ LMF31-2020B  |                 | CZ LMF33-2008B |
| Relay output                        |                 |   |   |  |   |                 |                 |                |
| Controloutput                       | DC              | 200mA   | 200mA   |  |   |                 |                 |                |
|                                     | SCR/Relay       | 300mA   | 300mA   |  |   |                 |                 |                |
| Output voltage drop DC/AC           |                 | (NPN PNP) 3V :3.9V AC 10V DC<3V AC<10V  |   |  |   |                 |                 |                |
| Consumption current                 |                 | (NPN PNP) DC 12V 8mA 24V 15mA AC 10mA DC<15mA AC<10mA                             |   |  |   |                 |                 |                |
| Standard detected object            |                 |   |   |  |   |                 |                 |                |
| Repeated precision                  |                 | 0.5   | 0.5   |  |   |                 |                 |                |
| DC/AC                               |                 | 200Hz/10Hz  | 200Hz/10Hz  |  |   |                 |                 |                |
| Working environment temperature     |                 | -25°C~+65°C   | -25°C~+65°C   |  |   |                 |                 |                |
| Insulation resistance               |                 | 50MΩ  | 50MΩ  |  |   |                 |                 |                |
| Shell material                      |                 | Metal   | Metal   |  |   |                 |                 |                |
| Protection grade                    |                 | IP67  | IP67  |  |   |                 |                 |                |
| Alyemative model at home and abroad |                 | EZE-X18ME1-M1   |   |  |   |                 |                 |                |