

DT0150.0/3A/19.5x10

SPECIFICATION FOR APPROVAL

1、 DIMENSIONS (UNIT:mm) :

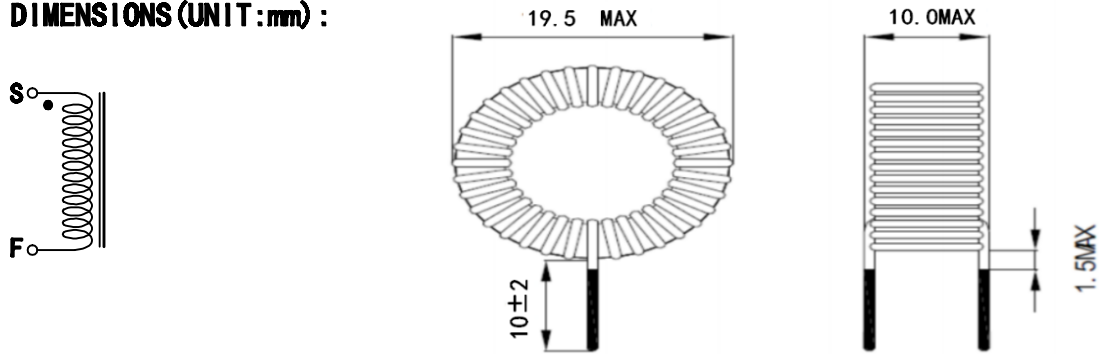

2、 ELECTRICAL CHARACTERISTICS:

L(S-F) : 150.0uH ± 10%	RATED CURRENT : 3A MAX
DCR : 90mΩ MAX	
	MEASURING INSTRUMENT : TH2810B LCR1KHz/1V

3、 MATERIAL LIST:

WIRE : N1 (S-F) : 2UEW φ 0.6mm x 52.0Ts ;