

DTMSS-16 SENDUST POWER INDUCTORS



APPLICATIONS:

- interference suppressing chokes (DC - 300kHz)
- energy storage inductors (DC - 300kHz)
- DC/DC converters
- SMPS
- EMI filters (DC - 1 MHz)
- acoustic filters

ORDERING CODE:

DTMSS- 16 /0,68/0,2 - V

mounting: V - vertical, H - horizontal, BV - base vertical,
CV - case vertical, CH - case horizontal, KM3 - base vertical
rated current in Amps
inductance in mH@ $I_{DC} = 0A$
sendust core outer diameter
product symbol

DIMENSIONS:

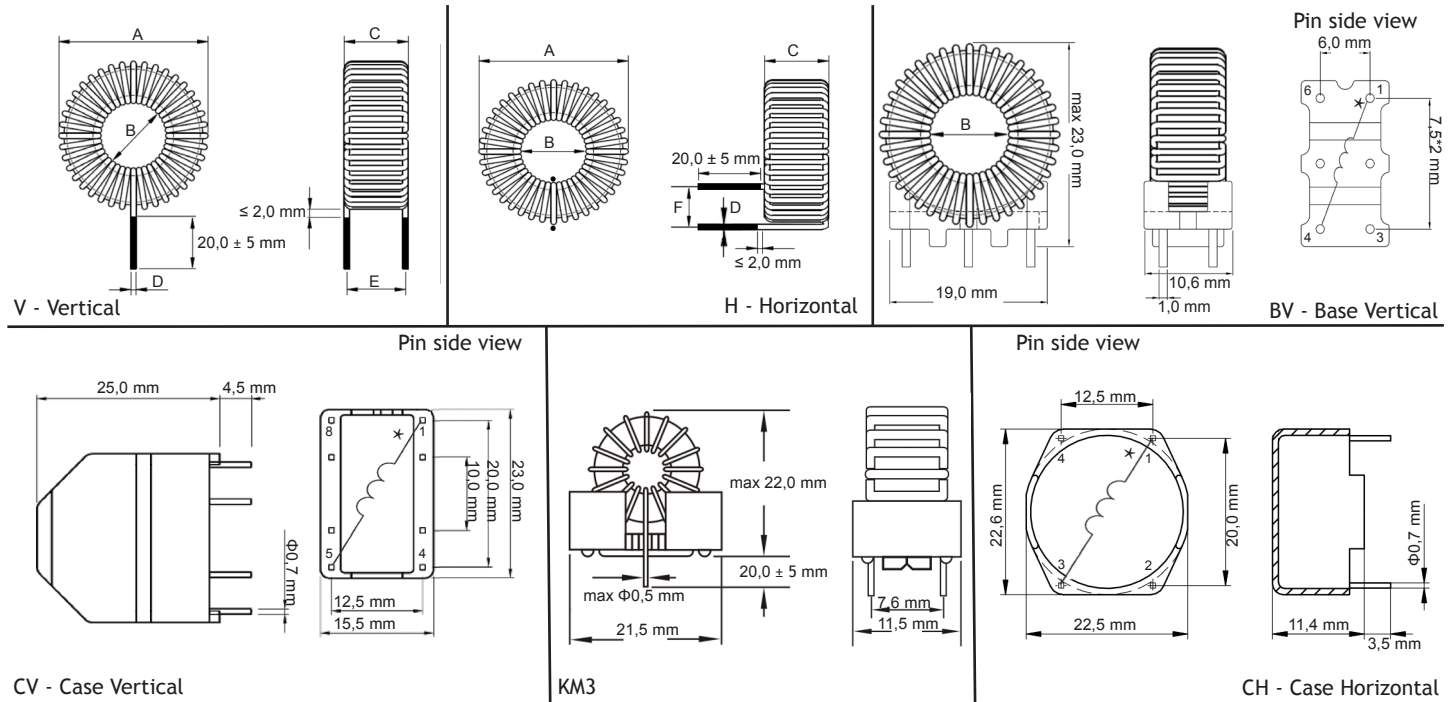

Part number	Dimensions ($\pm 10\%$)						Mounting version					
	A [mm]	B [mm]	C [mm]	D [mm]	E [mm]	F [mm]	V	H	BV	CV	CH	KM3
DTMSS-16/0,68/0,2	17,5	8,5	7,5	0,16	7,0	4,5	✓	✓	✓	✓	✓	✓
DTMSS-16/0,47/0,3	18,0	8,5	7,5	0,20	7,0	4,5	✓	✓	✓	✓	✓	✓
DTMSS-16/0,33/0,4	18,0	8,5	7,5	0,25	7,0	4,5	✓	✓	✓	✓	✓	✓
DTMSS-16/0,22/0,7	18,0	8,0	8,0	0,30	7,0	5,0	✓	✓	✓	✓	✓	✓
DTMSS-16/0,15/1,0	18,5	8,0	8,0	0,35	7,0	5,0	✓	✓	✓	✓	✓	✓
DTMSS-16/0,10/1,6	18,5	7,0	9,0	0,45	8,0	5,0	✓	✓	✓	✓	✓	✓
DTMSS-16/0,068/2,0	18,5	7,0	9,0	0,50	8,0	5,0	✓	✓	✓	✓	✓	✓
DTMSS-16/0,047/4,0	20,0	5,5	9,5	1,00	8,0	7,0	✓	✓	-	✓	✓	-
DTMSS-16/0,033/6,0	20,0	5,0	10,0	1,25	9,0	7,5	✓	✓	-	-	-	-
DTMSS-16/0,022/8,0	20,0	4,5	10,0	1,50	9,0	8,0	✓	✓	-	-	-	-
DTMSS-16/0,015/10	21,0	3,5	10,5	1,60	9,0	8,0	✓	✓	-	-	-	-
DTMSS-16/0,010/15	22,0	2,25	11,0	2,00	9,0	8,0	✓	✓	-	-	-	-
DTMSS-16/0,0068/20	22,0	1,2	12,0	2,80	9,0	10,5	✓	✓	-	-	-	-

ELECTRICAL PROPERTIES:

Part number	Lmax [μH]	I _{max} [A]	L@I _{max} [μH]	RDC [Ω]	Δt [°C]
DTMSS-16/0,68/0,2	680	0,20	673	2,48	6,6
DTMSS-16/0,47/0,3	470	0,30	464	1,23	7,6
DTMSS-16/0,33/0,4	330	0,40	324	0,907	10,6
DTMSS-16/0,22/0,7	220	0,70	212	0,460	12,6
DTMSS-16/0,15/1,0	150	1,00	140	0,239	13,0
DTMSS-16/0,10/1,6	100	1,60	89	0,123	16,0
DTMSS-16/0,068/2,0	68	2,00	61	0,0876	20,0
DTMSS-16/0,047/4,0	47	4,00	36	0,0453	36,3
DTMSS-16/0,033/6,0	33	6,00	23	0,0245	41,3
DTMSS-16/0,022/8,0	22	8,00	15	0,0166	46,3
DTMSS-16/0,015/10	15	10,0	10	0,00856	31,6
DTMSS-16/0,010/15	10	15,0	5,3	0,00430	37,1
DTMSS-16/0,0068/20	7	20,0	3,5	0,00318	37,7

CHARACTERISTICS:

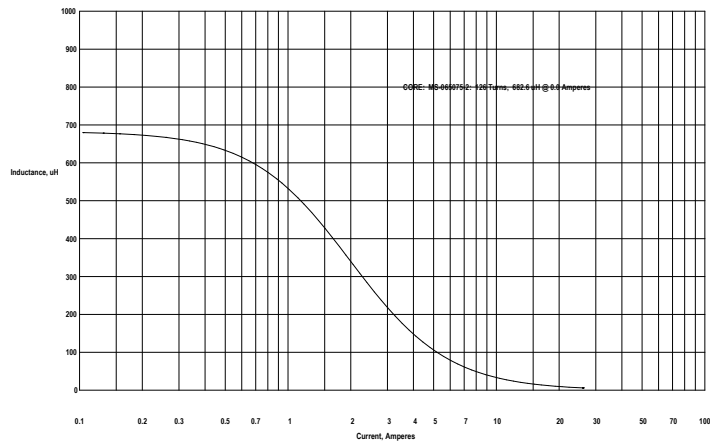

CREATED IN MICROMETALS ARNOLD POWDER CORES - DESIGN OF INDUCTORS FOR POWER FILTER APPLICATIONS Wed Nov 23 12:29:43 2011

DTMSS-16/0,68/0,2

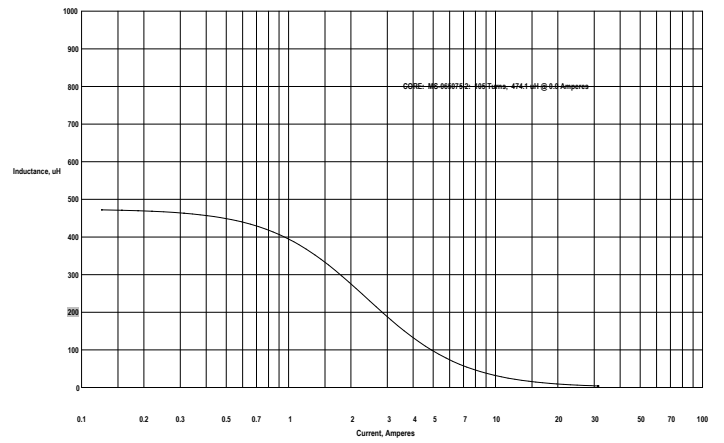

CREATED IN MICROMETALS ARNOLD POWDER CORES - DESIGN OF INDUCTORS FOR POWER FILTER APPLICATIONS Wed Nov 23 12:24:35 2011

DTMSS-16/0,47/0,3

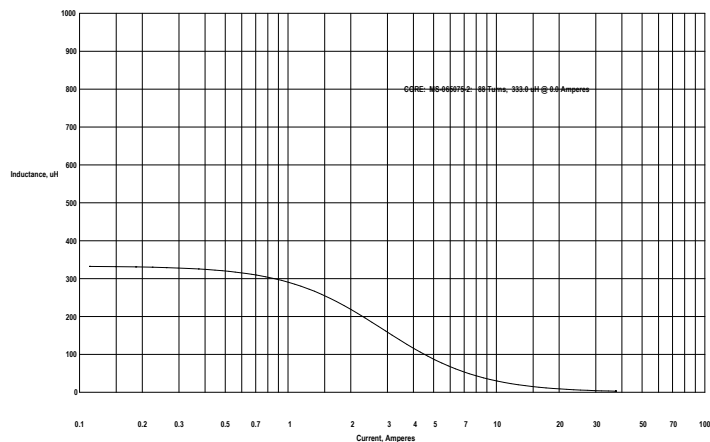

CREATED IN MICROMETALS ARNOLD POWDER CORES - DESIGN OF INDUCTORS FOR POWER FILTER APPLICATIONS Wed Nov 23 12:28:05 2011

DTMSS-16/0,33/0,4

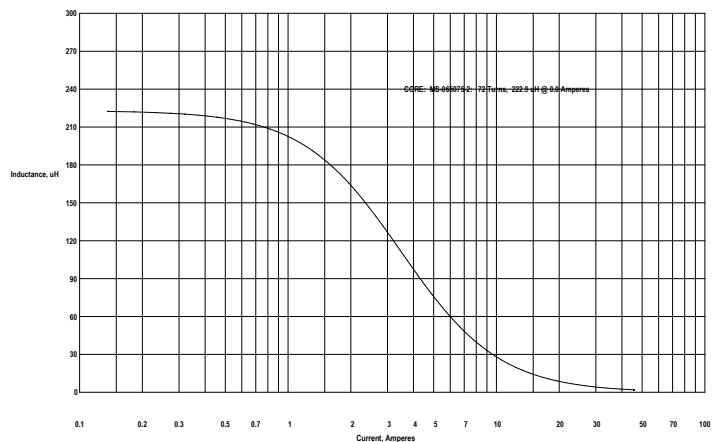

CREATED IN MICROMETALS ARNOLD POWDER CORES - DESIGN OF INDUCTORS FOR POWER FILTER APPLICATIONS Wed Nov 23 12:27:26 2011

DTMSS-16/0,22/0,7

CHARACTERISTICS:

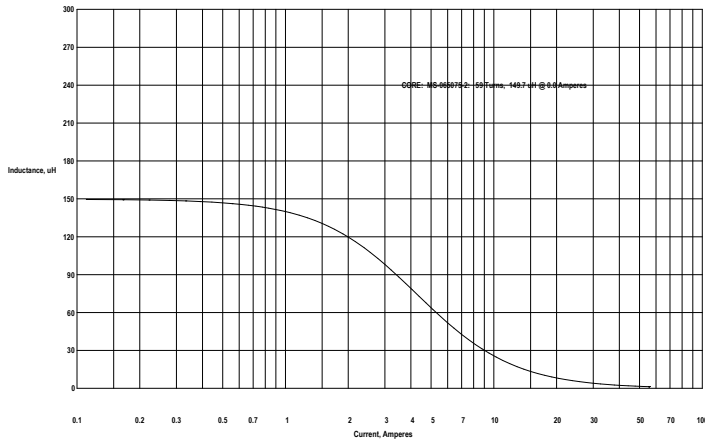

CREATED IN MICROMETALS ARNOLD POWDER CORES - DESIGN OF INDUCTORS FOR POWER FILTER APPLICATIONS Wed Nov 23 12:29:10 2011

DTSS-16/0,15/1,0

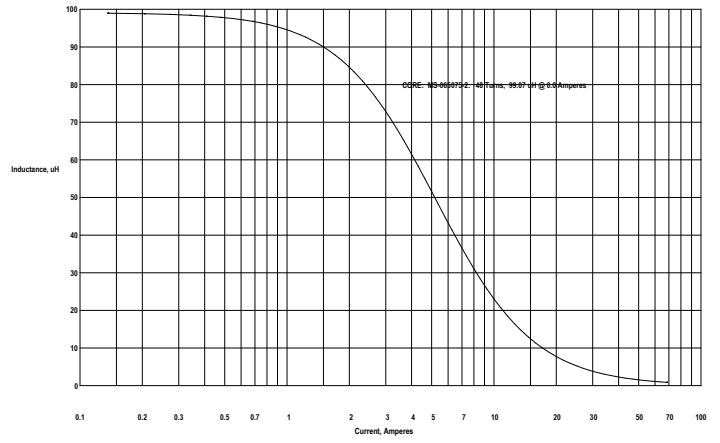

CREATED IN MICROMETALS ARNOLD POWDER CORES - DESIGN OF INDUCTORS FOR POWER FILTER APPLICATIONS Wed Nov 23 12:30:58 2011

DTSS-16/0,1/1,6

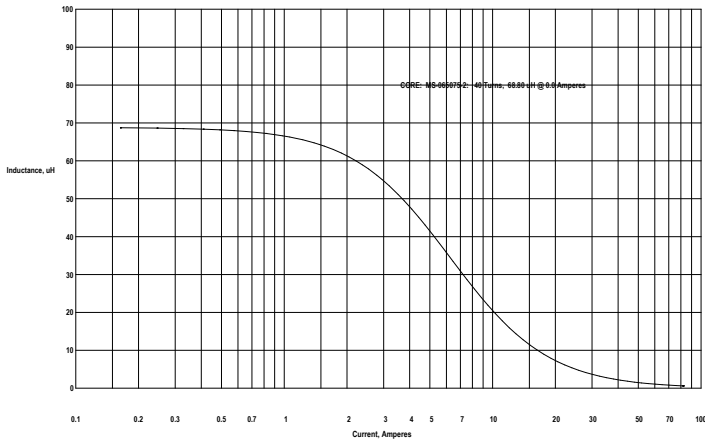

CREATED IN MICROMETALS ARNOLD POWDER CORES - DESIGN OF INDUCTORS FOR POWER FILTER APPLICATIONS Wed Nov 23 12:32:50 2011

DTSS-16/0,068/2,0

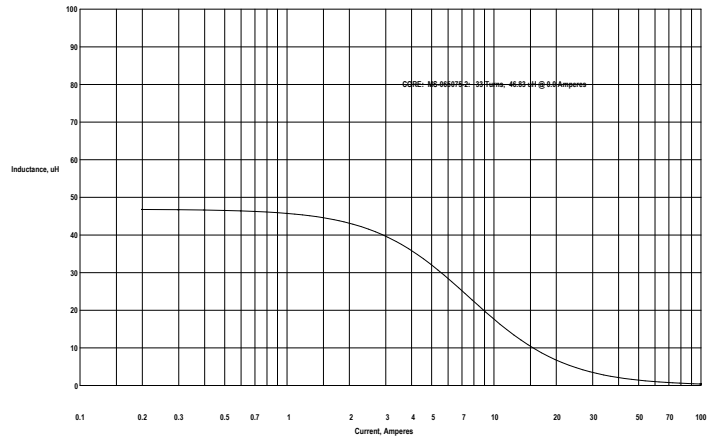

CREATED IN MICROMETALS ARNOLD POWDER CORES - DESIGN OF INDUCTORS FOR POWER FILTER APPLICATIONS Wed Nov 23 12:34:28 2011

DTSS-16/0,047/4,0

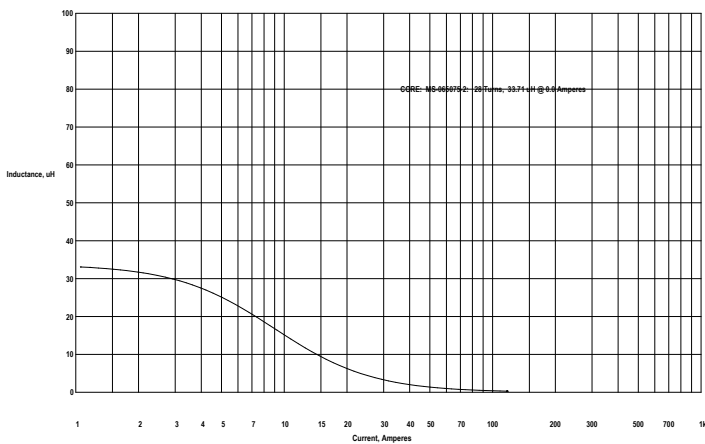

CREATED IN MICROMETALS ARNOLD POWDER CORES - DESIGN OF INDUCTORS FOR POWER FILTER APPLICATIONS Wed Nov 23 12:35:49 2011

DTSS-16/0,033/6,0

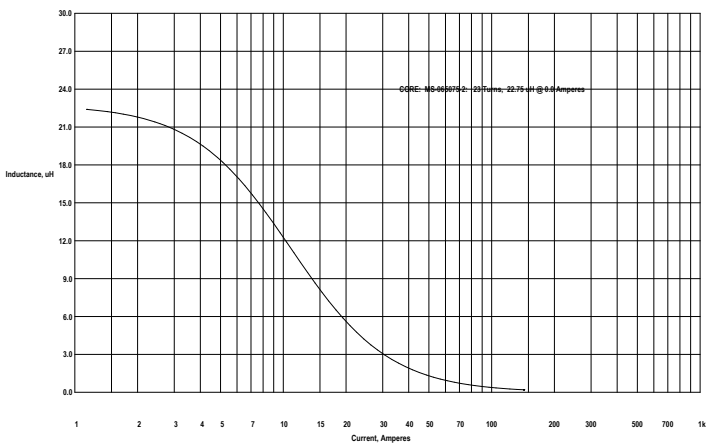

CREATED IN MICROMETALS ARNOLD POWDER CORES - DESIGN OF INDUCTORS FOR POWER FILTER APPLICATIONS Wed Nov 23 12:37:38 2011

DTSS-16/0,022/8,0

CHARACTERISTICS:

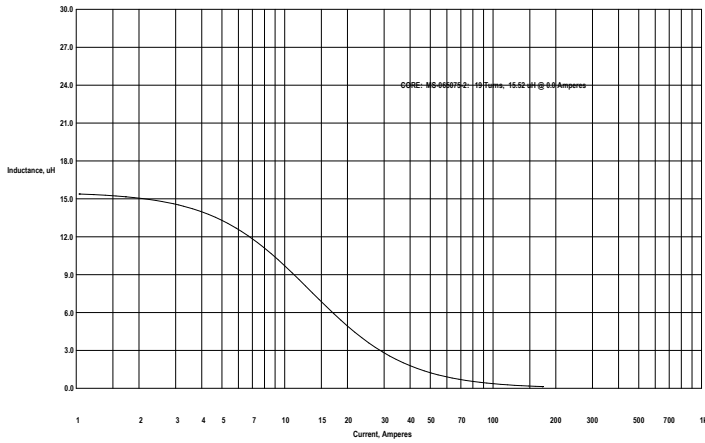

CREATED IN MICROMETALS ARNOLD POWDER CORES - DESIGN OF INDUCTORS FOR POWER FILTER APPLICATIONS Wed Nov 23 12:39:20 2011

DTMS-16/0,015/10

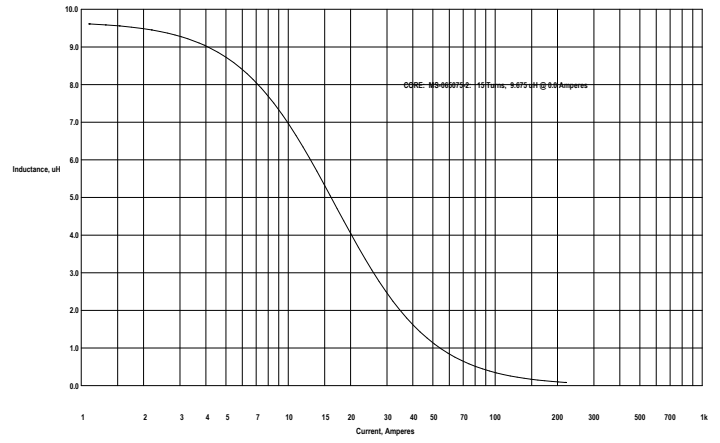

CREATED IN MICROMETALS ARNOLD POWDER CORES - DESIGN OF INDUCTORS FOR POWER FILTER APPLICATIONS Wed Nov 23 12:41:33 2011

DTMS-16/0,01/15

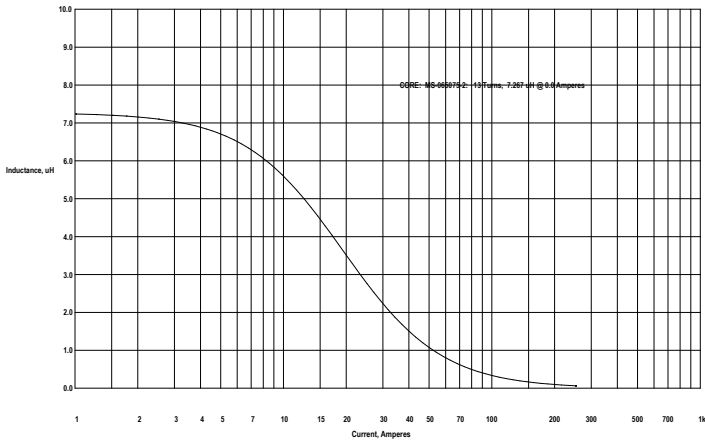

CREATED IN MICROMETALS ARNOLD POWDER CORES - DESIGN OF INDUCTORS FOR POWER FILTER APPLICATIONS Wed Nov 23 12:43:28 2011

DTMS-16/0,0068/20