

# FDD03 SERIES

DC - DC CONVERTER  
2 ~ 3W SINGLE & DUAL OUTPUT



## FEATURES

- EFFICIENCY UP TO 79%
- 4:1 & 3:1 & 2:1 WIDE INPUT RANGE
- I/O ISOLATION
- SHORT CIRCUIT PROTECTION
- HIGH PERFORMANCE
- 2 YEARS WARRANTY

## MODEL LIST

MODEL NO.	INPUT VOLTAGE	INPUT CURRENT (typ.)	OUTPUT WATTAGE	OUTPUT VOLTAGE	OUTPUT CURRENT	EFF. (min.)	EFF. (typ.)	CAPACITOR LOAD (max.)
-----------	---------------	----------------------	----------------	----------------	----------------	-------------	-------------	-----------------------

### Single Output Models

FDD03 - 05S	20~60 VDC	70 mA	2.5 WATTS	+ 5 VDC	500 mA	72%	74%	1000 $\mu$ F
FDD03 - 12S	20~60 VDC	80 mA	3 WATTS	+ 12 VDC	250 mA	77%	79%	470 $\mu$ F
FDD03 - 15S	20~60 VDC	80 mA	3 WATTS	+ 15 VDC	200 mA	77%	79%	330 $\mu$ F
FDD03 - 05S1	9~18 VDC	265 mA	2 WATTS	+ 5 VDC	400 mA	63%	65%	1000 $\mu$ F
FDD03 - 12S1	9~18 VDC	310 mA	2.4 WATTS	+ 12 VDC	200 mA	65%	67%	470 $\mu$ F
FDD03 - 15S1	9~18 VDC	285 mA	2.4 WATTS	+ 15 VDC	160 mA	65%	67%	330 $\mu$ F
FDD03 - 05S2	18~36 VDC	155 mA	2.5 WATTS	+ 5 VDC	500 mA	67%	69%	1000 $\mu$ F
FDD03 - 12S2	18~36 VDC	175 mA	3 WATTS	+ 12 VDC	250 mA	70%	72%	470 $\mu$ F
FDD03 - 15S2	18~36 VDC	175 mA	3 WATTS	+ 15 VDC	200 mA	70%	72%	330 $\mu$ F
FDD03 - 05S3	36~72 VDC	70 mA	2.5 WATTS	+ 5 VDC	500 mA	72%	74%	1000 $\mu$ F
FDD03 - 12S3	36~72 VDC	80 mA	3 WATTS	+ 12 VDC	250 mA	77%	79%	470 $\mu$ F
FDD03 - 15S3	36~72 VDC	80 mA	3 WATTS	+ 15 VDC	200 mA	77%	79%	330 $\mu$ F
FDD03 - 05S4	9~36 VDC	155 mA	2.5 WATTS	+ 5 VDC	500 mA	67%	69%	1000 $\mu$ F
FDD03 - 12S4	9~36 VDC	175 mA	3 WATTS	+ 12 VDC	250 mA	70%	72%	470 $\mu$ F
FDD03 - 15S4	9~36 VDC	175 mA	3 WATTS	+ 15 VDC	200 mA	70%	72%	330 $\mu$ F
FDD03 - 05S5	18~72 VDC	70 mA	2.5 WATTS	+ 5 VDC	500 mA	72%	74%	1000 $\mu$ F
FDD03 - 12S5	18~72 VDC	80 mA	3 WATTS	+ 12 VDC	250 mA	77%	79%	470 $\mu$ F
FDD03 - 15S5	18~72 VDC	80 mA	3 WATTS	+ 15 VDC	200 mA	77%	79%	330 $\mu$ F

### Dual Output Models

FDD03 - 05D	20~60 VDC	70 mA	2.5 WATTS	$\pm$ 5 VDC	$\pm$ 250 mA	73%	75%	$\pm$ 100 $\mu$ F
FDD03 - 12D	20~60 VDC	80 mA	3 WATTS	$\pm$ 12 VDC	$\pm$ 125 mA	75%	77%	$\pm$ 47 $\mu$ F
FDD03 - 15D	20~60 VDC	80 mA	3 WATTS	$\pm$ 15 VDC	$\pm$ 100 mA	75%	77%	$\pm$ 22 $\mu$ F
FDD03 - 05D1	9~18 VDC	265 mA	2 WATTS	$\pm$ 5 VDC	$\pm$ 200 mA	63%	65%	$\pm$ 100 $\mu$ F
FDD03 - 12D1	9~18 VDC	310 mA	2.4 WATTS	$\pm$ 12 VDC	$\pm$ 100 mA	65%	67%	$\pm$ 47 $\mu$ F
FDD03 - 15D1	9~18 VDC	310 mA	2.4 WATTS	$\pm$ 15 VDC	$\pm$ 80 mA	65%	67%	$\pm$ 22 $\mu$ F
FDD03 - 05D2	18~36 VDC	155 mA	2.5 WATTS	$\pm$ 5 VDC	$\pm$ 250 mA	66%	68%	$\pm$ 100 $\mu$ F
FDD03 - 12D2	18~36 VDC	180 mA	3 WATTS	$\pm$ 12 VDC	$\pm$ 125 mA	68%	70%	$\pm$ 47 $\mu$ F

### MODEL LIST

MODEL NO.	INPUT VOLTAGE	INPUT CURRENT (typ.)   (max.)		OUTPUT WATTAGE	OUTPUT VOLTAGE	OUTPUT CURRENT	EFF. (min.)	EFF. (typ.)	CAPACITOR LOAD (max.)
-----------	---------------	----------------------------------	--	----------------	----------------	----------------	-------------	-------------	-----------------------

#### Dual Output Models

FDD03 - 15D2	18~36 VDC	180 mA	230 mA	3 WATTS	± 15 VDC	± 100 mA	68%	70%	± 22 $\mu$ F
FDD03 - 05D3	36~72 VDC	70 mA	100 mA	2.5 WATTS	± 5 VDC	± 250 mA	73%	75%	± 100 $\mu$ F
FDD03 - 12D3	36~72 VDC	80 mA	110 mA	3 WATTS	± 12 VDC	± 125 mA	75%	77%	± 47 $\mu$ F
FDD03 - 15D3	36~72 VDC	80 mA	110 mA	3 WATTS	± 15 VDC	± 100 mA	75%	77%	± 22 $\mu$ F
FDD03 - 05D4	9~36 VDC	155 mA	440 mA	2.5 WATTS	± 5 VDC	± 250 mA	66%	68%	± 100 $\mu$ F
FDD03 - 12D4	9~36 VDC	180 mA	510 mA	3 WATTS	± 12 VDC	± 125 mA	68%	70%	± 47 $\mu$ F
FDD03 - 15D4	9~36 VDC	180 mA	510 mA	3 WATTS	± 15 VDC	± 100 mA	68%	70%	± 22 $\mu$ F
FDD03 - 05D5	18~72 VDC	70 mA	200 mA	2.5 WATTS	± 5 VDC	± 250 mA	73%	75%	± 100 $\mu$ F
FDD03 - 12D5	18~72 VDC	80 mA	225 mA	3 WATTS	± 12 VDC	± 125 mA	75%	77%	± 47 $\mu$ F
FDD03 - 15D5	18~72 VDC	80 mA	225 mA	3 WATTS	± 15 VDC	± 100 mA	75%	77%	± 22 $\mu$ F

### SPECIFICATION

All Specifications Typical At Nominal Line, Full Load, 25°C Unless Otherwise Noticed

#### GENERAL

Characteristics	Conditions	min.	typ.	max.	unit
Switching frequency	Vi nom, Io nom	50			KHz
Isolation voltage	Input - Output	1500			VDC
Isolation resistance	Input - Output, @ 500VDC	100			M $\Omega$
Ambient temperature	Operating at Vi nom, Io nom	-40		+ 71	°C
Case temperature	Operating at Vi nom, Io nom			+ 90	°C
Derating	Vi nom	See derating curve			
Storage temperature	Non operational	-40		+ 100	°C
Relative humidity	Vi nom, Io nom	20		95	% RH
Temperature coefficient	Vi nom, Io min			± 0.02	% / °C
Dimension		L31.8 x W20.3 x H12.7			mm
MTBF	Bellcore issue 6@40°C, GB		1640000		Hours
Cooling	Free air convection				

#### INPUT SPECIFICATIONS

Characteristics	Conditions	min.	typ.	max.	unit	
Input voltage range	Ta min ... Ta max, Io nom	2 : I models	9	12	18	VDC
			18	24	36	VDC
			36	48	72	VDC
		3 : I models	20	48	60	VDC
		4 : I models	9	24	36	VDC
			18	48	72	VDC
No load input current	Vi nom, Io = 0	12V models			18	mA
		24V models			15	mA
		48V models			8	mA
Input voltage w/o damage	Io nom	12V models			20	VDC
		24V models			40	VDC
		48V models			75	VDC
Startup voltage	Io nom	12V models		7.2	VDC	
		24V models		7.2	VDC	
		48V models		16.1	VDC	

### SPECIFICATION

All Specifications Typical At Nominal Line, Full Load, 25°C Unless Otherwise Noticed

### OUTPUT SPECIFICATIONS

Characteristics	Conditions	min.	typ.	max.	unit
Output voltage accuracy	Vi nom, Io nom			± 2	%
Minimum load	Vi nom, single output models	0			%
	Vi nom, dual output models (each output)	20			%
Line regulation	Io nom, Vi min ...Vi max			± 1	%
Load regulation	Vi nom, Io 0 ...Io nom, single output models			± 2	%
	Vi nom, Io min ...Io nom, dual output models			± 5	%
Cross regulation (Dual model)	Aymmetrical load 20% - 100% FL			± 10	%
Startup time	Vi nom, Io nom			30	ms
Transient recovery time	Vi nom, I ~0.5 Io nom			3	ms
Ripple & noise	Vi nom, Io nom, BW = 20MHz			300	mV
Efficiency	Vi nom, Io nom, Po / Pi	Up to 79%, See model list and efficiency curve			

### CONTROL AND PROTECTION

Input reversed	External shunt diode, external fuse recommended ( 12Vin : 0.75A, 24Vin : 0.75A, 48Vin : 0.5A )
Output short circuit	Current limited (Auto-recovery)

### PHYSICAL CHARACTERISTICS

Case size	31.8 x 20.3 x 12.7 mm (1.25 x 0.8 x 0.5 inches)
Case material	Plastic
Weight	15 g
Patting material	Epoxy

### MECHANISM & PIN CONFIGURATION

mm [inch]

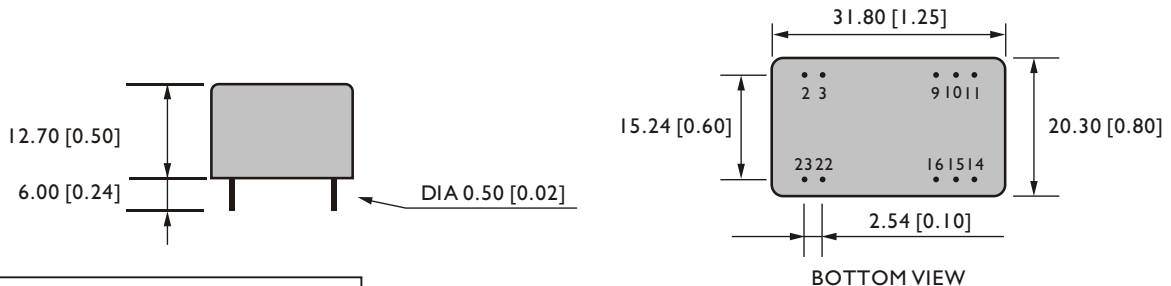

GENERAL TOLERANCE	
0.00[0.00] - 30.00[1.18]	±0.30[0.01]
30.00[1.18] - 120.00[4.72]	±0.50[0.02]

### PIN ASSIGNMENT

#### GENERAL

PIN NO.	2&3	9	10&15	11	14	16	22&23
SINGLE	Vi -	N. C.	N. C.	N. C.	Vo+	Vo -	Vi+
DUAL	Vi -	com	N. C.	Vo-	Vo+	com	Vi+

### APPLICATION CIRCUIT

a. SINGLE OUTPUT MODELS :

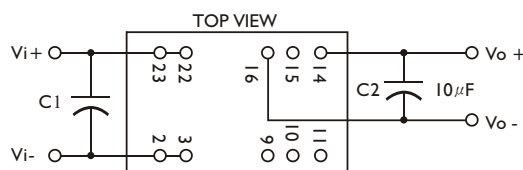

b. DUAL OUTPUT MODELS :

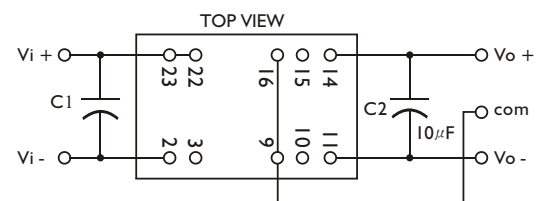

#### NOTE:

a. C1=4.7µF / 100V, C2=10µF

b. C1 MUST BE ADDED WHEN APPLICATION .

c. C2 OPTIONAL TO MINIMIZE THE R & N < 100mV .

d. MAX. 80% LOAD WHEN INPUT VOLTAGE AT 9-11VDC FOR 9-36VDC INPUT MODELS & 18-21VDC FOR 18-72VDC INPUT MODELS .

### CIRCUIT SCHEMATIC

• Block diagram for FDD03 series with single output

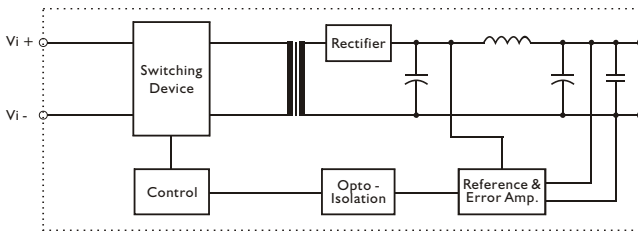

• Block diagram for FDD03 series with dual output

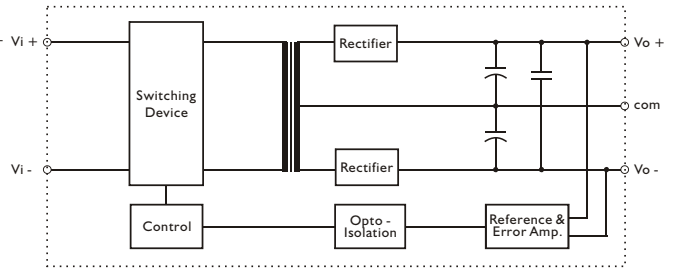

### RECOMMENDED CIRCUIT

• Recommended filter for EN55022 Class B compliance

SINGLE OUTPUT MODELS

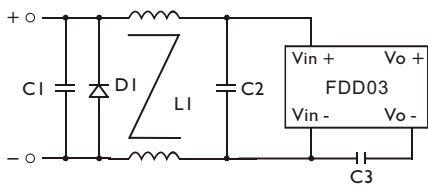

DUAL OUTPUT MODELS

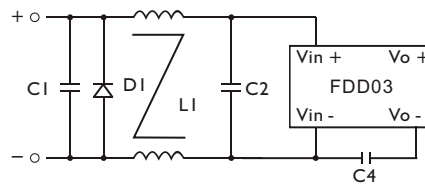

Note: D1 - Reverse Diode (1A/100V)

• The components used in the above figure, together with the manufacturer part numbers for these components, are as follows.

	C1	C2	C3	C4	L1
FDD03-XXSX	6.8 $\mu$ F / 100V MLCC	4.7 $\mu$ F / 100V MLCC	InF/2KV MLCC		3mH Common Choke
FDD03-XXDX	6.8 $\mu$ F / 100V MLCC	4.7 $\mu$ F / 100V MLCC		InF/2KV MLCC	3mH Common Choke

• Recommended EN 55022 Class B filter circuit layout.

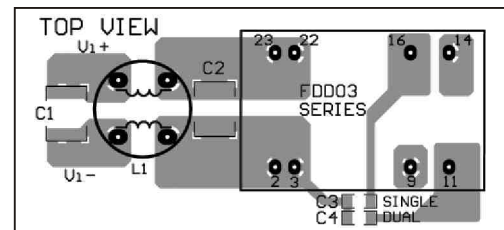

### DERATING AND EFFICIENCY CURVE

Temperature derating curve

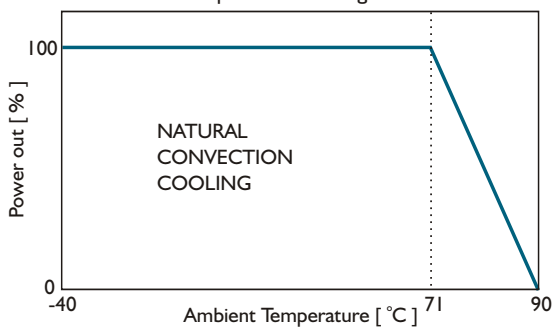

Efficiency Vs Input Voltage  
FDD03-05S4

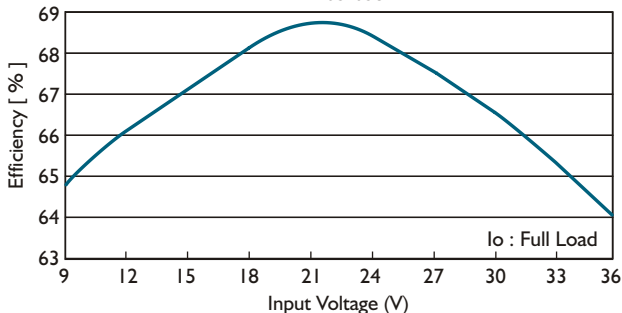

Efficiency Vs Output Load  
FDD03-05S4

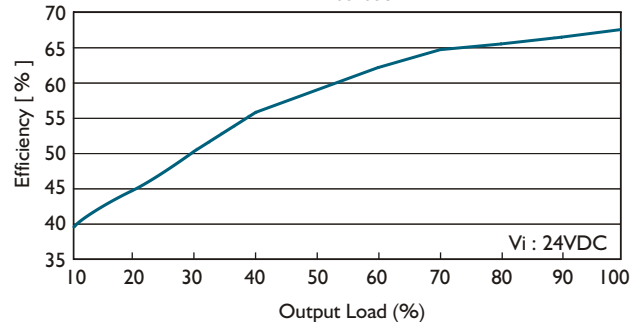

# FDD03 SERIES

DC - DC CONVERTER  
2.5 ~ 3W WITH REMOTE FUNCTION



## FEATURES

- 4:1 WIDE INPUT RANGE
- DIP24 PACKAGE
- I/O, O/O ISOLATION
- SHORT CIRCUIT PROTECTION
- HIGH PERFORMANCE
- 2 YEARS WARRANTY

## MODEL LIST

MODEL NO.	INPUT VOLTAGE	INPUT CURRENT (typ.)	OUTPUT WATTAGE	OUTPUT VOLTAGE	OUTPUT CURRENT	EFF. (min.)	EFF. (typ.)	CAPACITOR LOAD (max.)
-----------	---------------	----------------------	----------------	----------------	----------------	-------------	-------------	-----------------------

### Single Output Models

FDD03 - 05S4A	9~36 VDC	160 mA	2.5 WATTS	+ 5 VDC	500 mA	65%	67%	1000 $\mu$ F
FDD03 - 12S4A	9~36 VDC	180 mA	3 WATTS	+ 12 VDC	250 mA	68%	70%	470 $\mu$ F
FDD03 - 15S4A	9~36 VDC	180 mA	3 WATTS	+ 15 VDC	200 mA	68%	70%	330 $\mu$ F
FDD03 - 05S5A	18~72 VDC	75 mA	2.5 WATTS	+ 5 VDC	500 mA	70%	72%	1000 $\mu$ F
FDD03 - 12S5A	18~72 VDC	80 mA	3 WATTS	+ 12 VDC	250 mA	75%	77%	470 $\mu$ F
FDD03 - 15S5A	18~72 VDC	80 mA	3 WATTS	+ 15 VDC	200 mA	75%	77%	330 $\mu$ F

### Dual Output Models

FDD03 - 05D4A	9~36 VDC	155 mA	2.5 WATTS	$\pm$ 5 VDC	$\pm$ 250 mA	66%	68%	$\pm$ 100 $\mu$ F
FDD03 - 12D4A	9~36 VDC	180 mA	3 WATTS	$\pm$ 12 VDC	$\pm$ 125 mA	68%	70%	$\pm$ 47 $\mu$ F
FDD03 - 15D4A	9~36 VDC	175 mA	3 WATTS	$\pm$ 15 VDC	$\pm$ 100 mA	68%	70%	$\pm$ 22 $\mu$ F
FDD03 - 05D5A	18~72 VDC	70 mA	2.5 WATTS	$\pm$ 5 VDC	$\pm$ 250 mA	72%	74%	$\pm$ 100 $\mu$ F
FDD03 - 12D5A	18~72 VDC	80 mA	3 WATTS	$\pm$ 12 VDC	$\pm$ 125 mA	75%	77%	$\pm$ 47 $\mu$ F
FDD03 - 15D5A	18~72 VDC	80 mA	3 WATTS	$\pm$ 15 VDC	$\pm$ 100 mA	75%	77%	$\pm$ 22 $\mu$ F

### Double Output Models

FDD03 - 0505D4A	9~36 VDC	160 mA	2.5 WATTS	5 / 5 VDC	250 / 250 mA	66%	68%	100 $\mu$ F
FDD03 - 1212D4A	9~36 VDC	180 mA	3 WATTS	12 / 12 VDC	125 / 125 mA	68%	70%	47 $\mu$ F
FDD03 - 1515D4A	9~36 VDC	175 mA	3 WATTS	15 / 15 VDC	100 / 100 mA	68%	70%	22 $\mu$ F
FDD03 - 0505D5A	18~72 VDC	70 mA	2.5 WATTS	5 / 5 VDC	250 / 250 mA	72%	74%	100 $\mu$ F
FDD03 - 1212D5A	18~72 VDC	80 mA	3 WATTS	12 / 12 VDC	125 / 125 mA	75%	77%	47 $\mu$ F
FDD03 - 1515D5A	18~72 VDC	80 mA	3 WATTS	15 / 15 VDC	100 / 100 mA	75%	77%	22 $\mu$ F

### NOTE :

MAX. 80% LOAD WHEN INPUT VOLTAGE AT 9-11VDC FOR 9-36VDC INPUT MODELS & 18-21VDC FOR 18-72VDC INPUT MODELS.

### SPECIFICATION

All Specifications Typical At Nominal Line, Full Load, 25°C Unless Otherwise Noticed

#### GENERAL

Characteristics	Conditions	min.	typ.	max.	unit
Switching frequency	Vi nom, Io nom	50			KHz
Isolation voltage	Input - Output	1500			VDC
Isolation resistance	Input - Output, @ 500VDC	100			MΩ
Ambient temperature	Operating at Vi nom, Io nom	-40		+71	°C
Case temperature	Operating at Vi nom, Io nom			+90	°C
Derating	Vi nom	See derating curve			
Storage temperature	Non operational	-40		+100	°C
Relative humidity	Vi nom, Io nom	20		95	% RH
Temperature coefficient	Vi nom, Io min			± 0.02	% / °C
Dimension		L31.8 x W20.3 x H12.7			mm
MTBF	Bellcore issue 6@40°C, GB		1640000		Hours
Cooling	Free air convection				

#### INPUT SPECIFICATIONS

Characteristics	Conditions	min.	typ.	max.	unit
Input voltage range	Ta min ... Ta max, Io nom	9	24	36	VDC
		18	48	72	VDC
No load input current	Vi nom, Io = 0	24V models		15	mA
		48V models		8	mA
Input voltage w/o damage	Io nom	24V models		40	VDC
		48V models		75	VDC
Startup voltage	Io nom	24V models	7.2		VDC
		48V models	16.1		VDC

#### OUTPUT SPECIFICATIONS

Characteristics	Conditions	min.	typ.	max.	unit
Output voltage accuracy	Vi nom, Io nom			± 2	%
Minimum load	Vi nom	0			%
	single output models				
	dual output models (each output)	20			%
Line regulation	Io nom, Vi min ... Vi max			± 1	%
Load regulation	Vi nom, Io 0 ... Io nom, single output models			± 2	%
	Vi nom, Io min ... Io nom, dual output models			± 5	%
Cross regulation (Dual model)	Aymmetrical load 20% - 100% FL			± 10	%
Startup time	Vi nom, Io nom			30	ms
Transient recovery time	Vi nom, I ~ 0.5 Io nom			3	ms
Ripple & noise	Vi nom, Io nom, BW = 20MHz			150	mV
Efficiency	Vi nom, Io nom, Po / Pi	Up to 77%, See model list and efficiency curve			

#### CONTROL AND PROTECTION

Remote ON / OFF	ON: opened or 5~10 VDC applied, reference to input GND OFF: -0.3~2 VDC applied, reference to input GND
Input reversed	External shunt diode, external fuse recommended ( 24Vin : 0.75A, 48Vin : 0.5A )
Output short circuit	Current limited (Auto-recovery)

### PHYSICAL CHARACTERISTICS

Case size	31.8 × 20.3 × 12.7 mm (1.25 × 0.8 × 0.5 inches)
Case material	Plastic
Weight	15 g
Patting material	Epoxy

### MECHANISM & PIN CONFIGURATION

mm [inch]

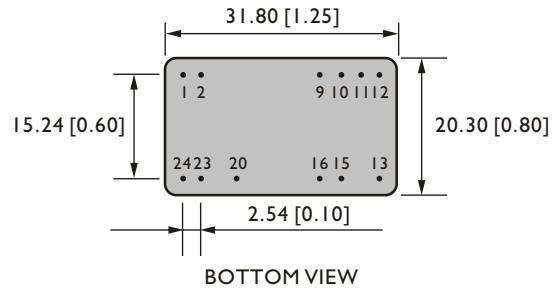
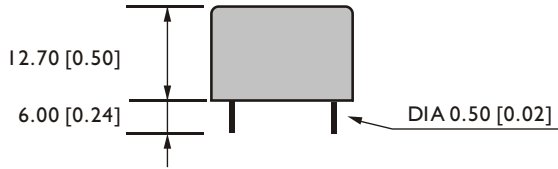

GENERAL TOLERANCE	
0.00[0.00] - 30.00[1.18]	±0.30[0.01]
30.00[1.18] - 120.00[4.72]	±0.50[0.02]

### PIN ASSIGNMENT

#### GENERAL

PIN NO.	1&2	9	10&11	12	13	15	16	20	23&24
SINGLE	Vi+	NO PIN	NO PIN	Vo-	Vo+	NO PIN	NO PIN	Remote ON/OFF	Vi-
DUAL	Vi+	NO PIN	com	NO PIN	Vo-	Vo+	NO PIN	Remote ON/OFF	Vi-
DOUBLE	Vi+	Vo1-	NO PIN	Vo1+	Vo2+	NO PIN	Vo2-	Remote ON/OFF	Vi-

### CIRCUIT SCHEMATIC

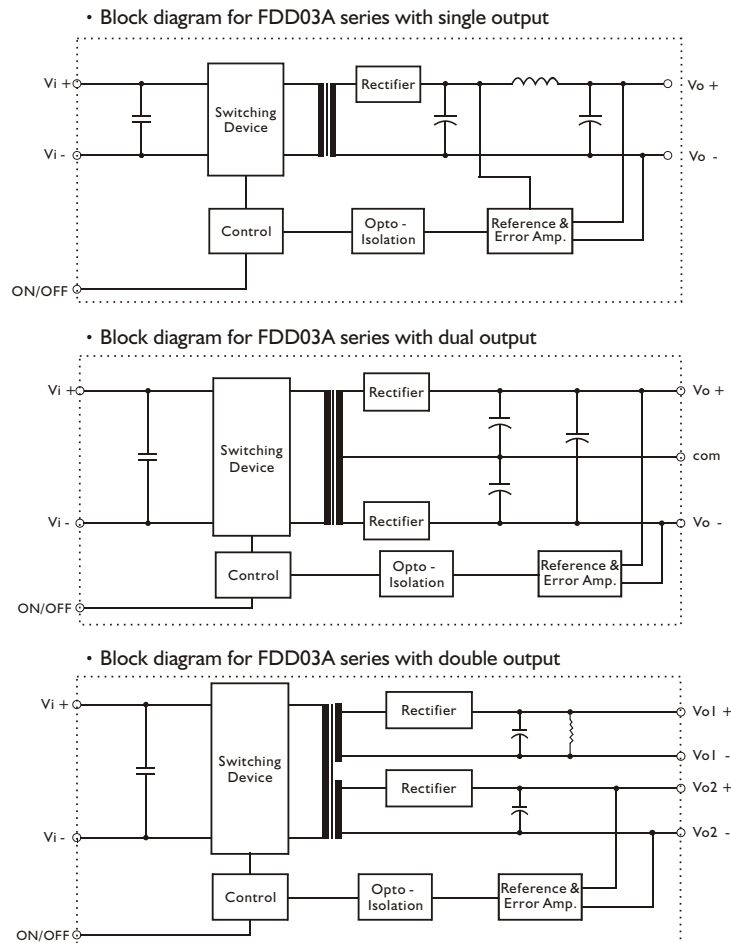

### RECOMMENDED CIRCUIT

- Recommended filter for EN55022 Class B compliance

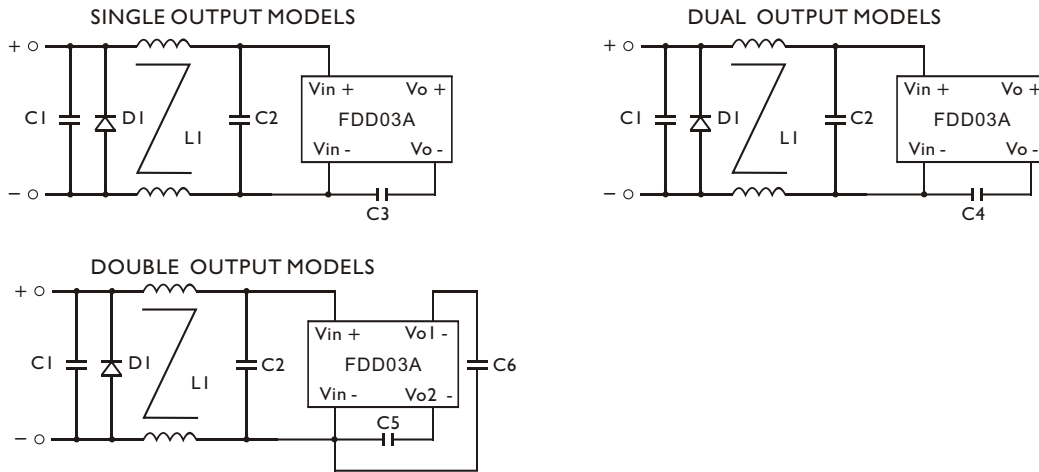

Note: D1 - Reverse Diode (1A / 100V)

- The components used in the above figure, together with the manufacturer part numbers for these components, are as follows.

	C1	C2	C3	C4	C5	C6	L1
FDD03-XXSXA	6.8 $\mu$ F / 100V MLCC	4.7 $\mu$ F / 100V MLCC	InF/2KV MLCC	/	/	/	3mH Common Choke
FDD03-XXDXA	6.8 $\mu$ F / 100V MLCC	4.7 $\mu$ F / 100V MLCC	/	InF/2KV MLCC	/	/	3mH Common Choke
FDD03-XXXXDXA	6.8 $\mu$ F / 100V MLCC	4.7 $\mu$ F / 100V MLCC	/	/	InF/2KV MLCC	InF/2KV MLCC	3mH Common Choke

- Recommended EN 55022 Class B filter circuit layout.

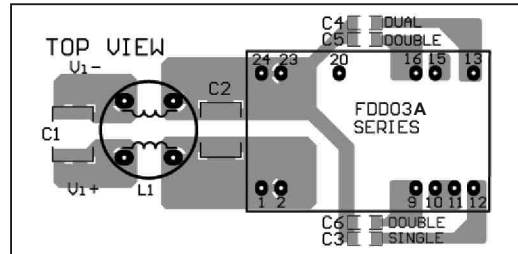

### DERATING AND EFFICIENCY CURVE

Temperature derating curve

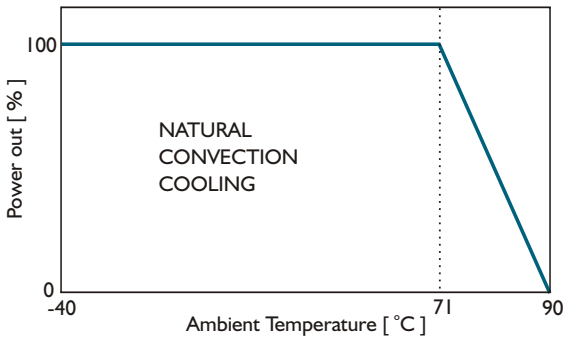

Efficiency Vs Input Voltage  
FDD03-05S4A

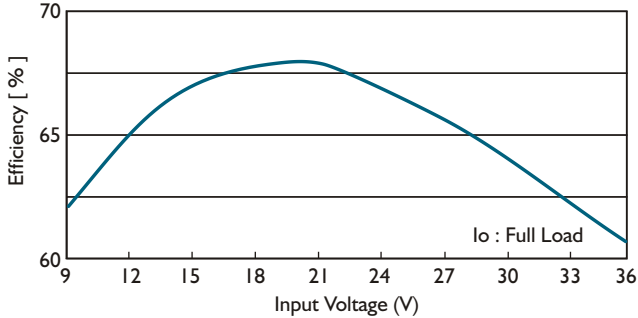

Efficiency Vs Output Load  
FDD03-05S4A

