

MORNSUN®

WRA_S - 1WR2 & WRB_S-1WR2 Series 1W, WIDE INPUT, ISOLATED & REGULATED DUAL/SINGLE OUTPUT DC-DC CONVERTER

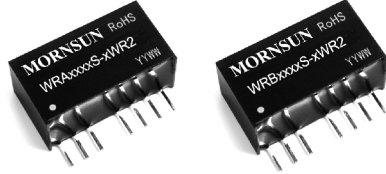

Patent Protection RoHS

PART NUMBER SYSTEM

WRB2405S-1WR2

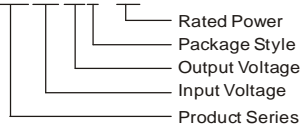

FEATURES

- Ultra-Miniature SIP Package
- 2:1 wide input voltage range
- Temperature range: -40°C ~ +85°C
- 1.5KVDC isolation
- Short Circuit Protection(automatic recovery)
- External On/Off control
- Without overshoot when turning On/Off
- UL94-V0 Package

APPLICATION

The WRA_S-1WR2 & WRB_S-1WR2 Series are specially designed for applications where a wide range input voltage power supplies are isolated from the input power supply in a distributed power supply system on a circuit board. For these DC-DC converters, You can reduce the design point of failure and save the development of micro power supply's manpower, material and time costs, also better ensure product quality stability, protect safety and reliability of the end of products.

These products apply to where:

- 1) Input voltage range $\leq 2:1$;
- 2) Input and output isolation $\leq 1.5KVDC$;
- 3) Regulated and low ripple noise is required.

Such as: industrial control, tele-communications etc.

SELECTION GUIDE

Model Number	Input Voltage(VDC)		Output Voltage (VDC)	Output Current (mA)		Input Current (mA)(typ.)		Reflected Ripple Current (mA,typ.)	Max. Capacitive Load(μ F)	Efficiency (% , typ.) @Max. Load
	Nominal (Range)	Max**		Max.	Min.	@Max. Load	@No Load			
WRA0505S-1WR2	5 (4.5-9)	11	± 5	± 100	± 5	270	25	30	1000	73
*WRA0512S-1WR2			± 12	± 41	± 2	260			470	75
*WRA0515S-1WR2			± 15	± 33	± 2	260			330	75
*WRB0505S-1WR2			5	200	10	278			2200	72
*WRB0512S-1WR2			12	83	4	260			1000	75
*WRB0515S-1WR2			15	67	3	260			680	75
*WRA1205S-1WR2	12 (9-18)	20	± 5	± 100	± 5	108	12	40	1000	77
*WRA1212S-1WR2			± 12	± 41	± 2	104			470	80
*WRA1215S-1WR2			± 15	± 33	± 2	104			330	80
WRB1205S-1WR2			5	200	10	107			2200	76
*WRB1212S-1WR2			12	83	4	104			1000	80
*WRB1215S-1WR2			15	41	3	103			680	81
WRA2405S-1WR2	24 (18-36)	40	± 5	± 100	± 5	52	6	55	1000	80
*WRA2412S-1WR2			± 12	± 41	± 2	52			470	80
*WRA2415S-1WR2			± 15	± 33	± 2	53			330	80
WRB2405S-1WR2			5	200	10	55			2200	76
*WRB2412S-1WR2			12	83	4	51			1000	81
*WRB2415S-1WR2			15	67	3	51			680	81
*WRB2424S-1WR2	24	42	2	51	470	81				
*WRA4805S-1WR2	48 (36-75)	80	± 5	± 100	± 5	27	4	70	1000	76
*WRA4812S-1WR2			± 12	± 41	± 2	26			470	80
WRA4815S-1WR2			± 15	± 33	± 2	27			330	78
WRB4805S-1WR2			5	200	10	27			2200	76
*WRB4812S-1WR2			12	83	4	26			1000	81
*WRB4815S-1WR2			15	67	3	25			680	81

Note: 1.*Designing.

2.**Input voltage can't exceed this value, or will cause the permanent damage.

INPUT SPECIFICATIONS					
Item	Test Conditions	Min.	Typ.	Max.	Unit
Input Surge Voltage (1sec. max.)	5V input	-0.7	--	12	VDC
	12V input	-0.7	--	25	
	24V input	-0.7	--	50	
	48V input	-0.7	--	100	
Start-up Voltage	5V input	3.5	4	4.5	
	12V input	4.5	8	9	
	24V input	11	16	18	
	48V input	24	33	36	
Input Filter		C Filter			

OUTPUT SPECIFICATIONS					
Item	Test Conditions	Min.	Typ.	Max.	Unit
Output Power		0.05	--	1	W
Output Voltage Accuracy	5% to 100% load	--	±1	±3	%
No-load Output Voltage Accuracy		--	±1.5	±5	
Output Voltage Balance	Dual output, balanced loads	--	±0.3	±0.5	
Line Regulation	Full load, Input voltage from low to high	--	±0.2	±0.5	
Load Regulation	5% to 100% load	--	±0.4	±0.75	
Transient Recovery Time	25% load step change	--	0.5	2	
Transient Response Deviation		--	±2.5	±5	%
Transient Response Deviation	100% load	--	±0.02	±0.03	%/°C
Ripple *	20MHz Bandwidth	--	30	50	mVp-p
Noise*		--	55	75	
Output Power Protection		120	--	--	%
Output Short Circuit Protection		Continuous, automatic recovery			
Note: Dual output models unbalanced load: ±5%. * Ripple and noise tested by "parallel cable" method. See detailed operation instructions at Testing of Power Converter section, application notes.					

COMMON SPECIFICATIONS					
Item	Test Conditions	Min.	Typ.	Max.	Unit
Isolation Voltage	Tested for 1 minute and leakage current less than 1 mA	1500	--	--	VDC
Isolation Resistance	Test at 500VDC	1000	--	--	MΩ
Isolation Capacitance	Input/Output, 100KHz/1V	--	100	--	pF
Switching Frequency	100% load, Stand Input voltage	--	200	--	KHz
MTBF	MIL-HDBK-217F @25°C	1000	--	--	K hours
Case Material		Plastic (UL94-V0)			
Weight		--	4.92	--	g

ENVIRONMENTAL SPECIFICATIONS					
Item	Test Conditions	Min.	Typ.	Max.	Unit
Storage Humidity	Non condensing	--	--	95	%
Operating Temperature	Power derating (above85°C)	-40	--	85	°C
Storage Temperature		-55	--	125	
Temp. rise at full load	Ta=25°C	--	25	--	
Lead Temperature	1.5mm from case for 10 seconds	--	--	300	
Cooling		Free air convection			

EMC SPECIFICATIONS

EMI	CE	CISPR22/EN55022	CLASS B (External Circuit Refer to Figure1-② or Figure 3)	
	RE	CISPR22/EN55022	CLASS B (External Circuit Refer to Figure1-② or Figure 3)	
EMS	ESD*	IEC/EN61000-4-2	Contact ±4KV/ Air ±8KV perf. Criteria B	
	RS	IEC/EN61000-4-3	10V/m perf. Criteria A	
	EFT	IEC/EN61000-4-4	±2KV	perf. Criteria B (External Circuit Refer to Figure1-①)
		IEC/EN61000-4-4	±4KV	perf. Criteria B (External Circuit Refer to Figure 3)
	Surge	IEC/EN61000-4-5	±2KV	perf. Criteria B (External Circuit Refer to Figure1-① or Figure 3)
	CS	IEC/EN61000-4-6	3 Vr.m.s	perf. Criteria A
Voltage dips, short and interruptions immunity		IEC/EN61000-4-29	0%-70% perf. Criteria B	

Note: *WRA/B24xxS-1WR2 (Without External Circuit) CTRL pin only can meet ESD Contact±2KV.

EMC RECOMMENDED CIRCUIT

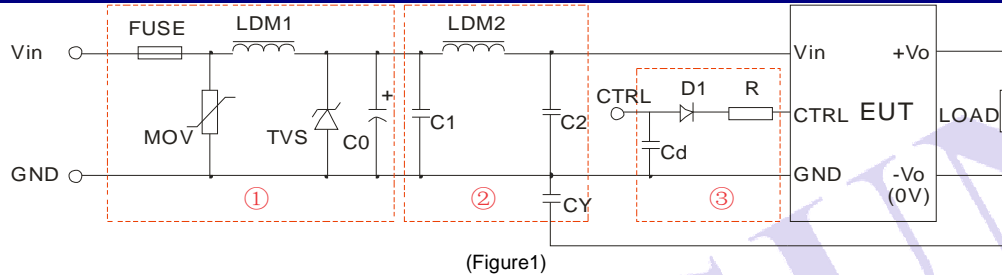

Recommended external circuit parameters:

Model	Vin:5V	Vin:12V	Vin:24V	Vin:48V
FUSE	Choose according to practical input current			
MOV	--	--	10D560	10D101
LDM1	--	--	56μH	
TVS	SMCJ13A	SMCJ28A	SMCJ48A	SMCJ90A
C0	680μF/25V		120μF/50V	120μF/100V
C1	4.7μF/50V		4.7μF/100V	
LDM2	12μH			
C2	4.7μF/50V		4.7μF/100V	
CY	1nF/2KV			
D1	RB160M-60/1A			
R	Follows: $R = \frac{V_c - V_D - 1.0}{I_c} - 300$			
Cd	47nF/100V			

- Note: 1. In Figure 1, part ① is EMS Recommended external circuit, part ② is EMI recommended external circuit. Choose according to requirements.
 2. If want to meet ESD Contact±4KV, CTRL pin must connect part ③.
 3. If there is no recommended parameters, the model no require the external component.

EMC RECOMMENDED CIRCUIT PCB LAYOUT

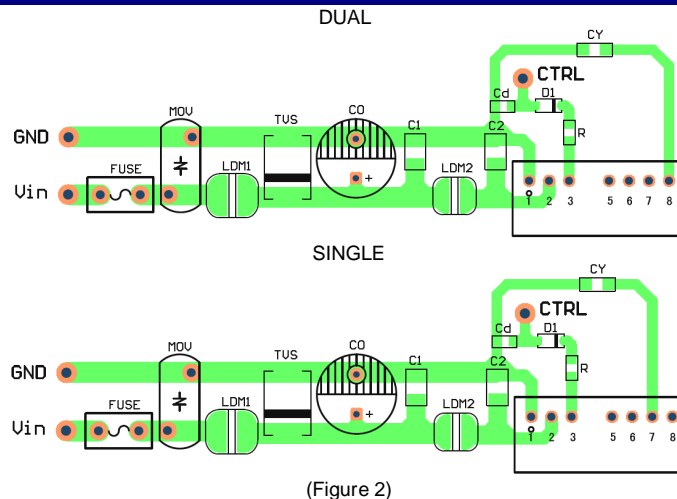

EMS MODULE APPLICATION CIRCUIT

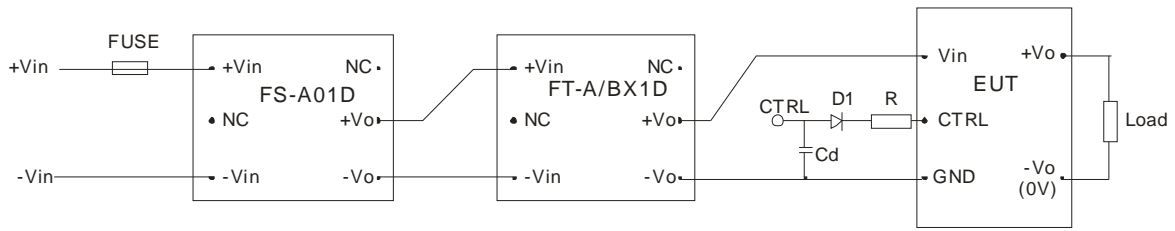

(Figure 3)

EMS MODULE RECOMMENDED CIRCUIT PCB LAYOUT

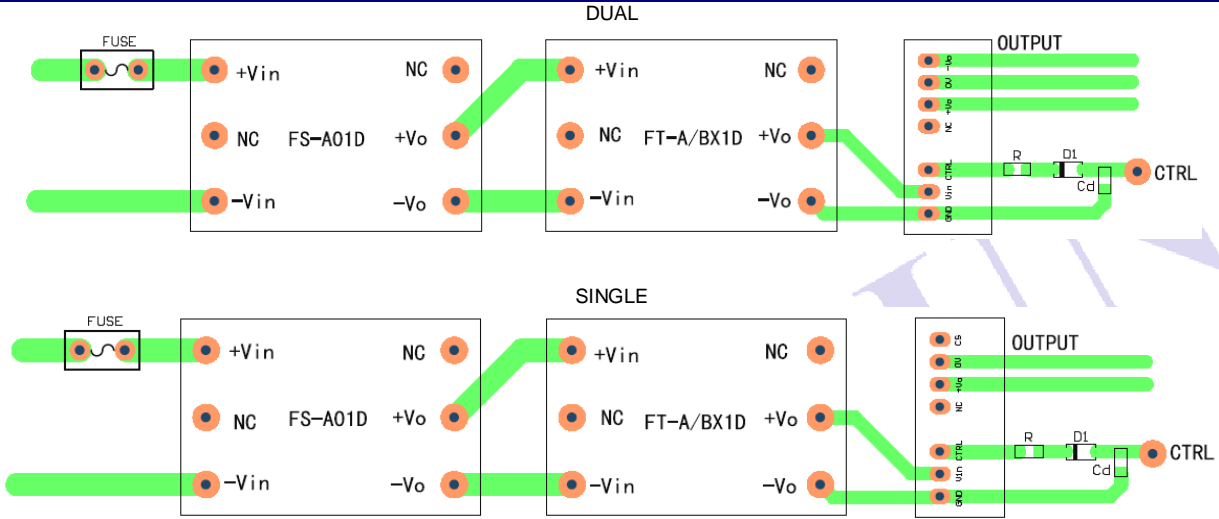

(Figure 4)

PRODUCT TYPICAL CURVE

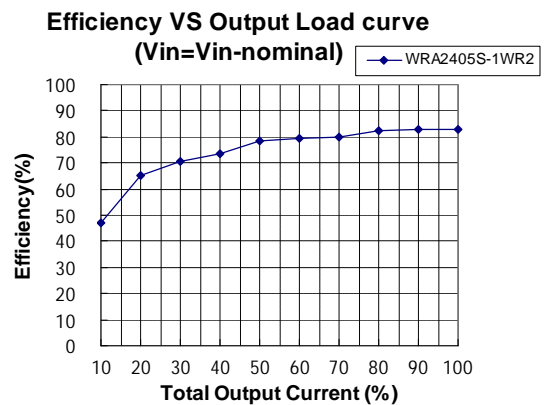
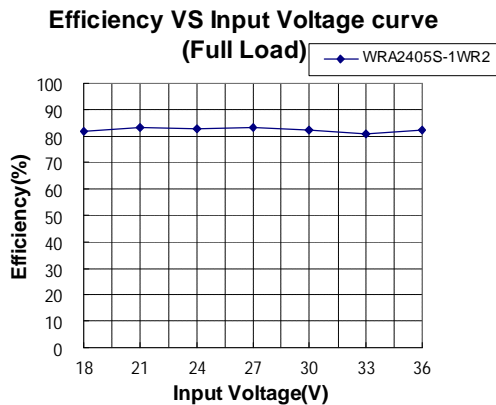
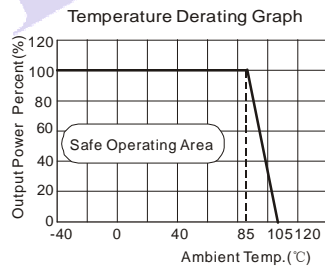

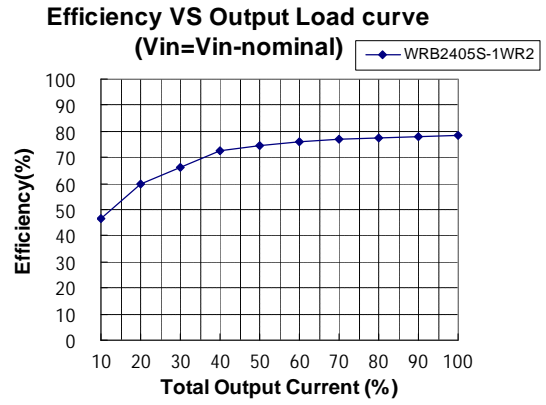
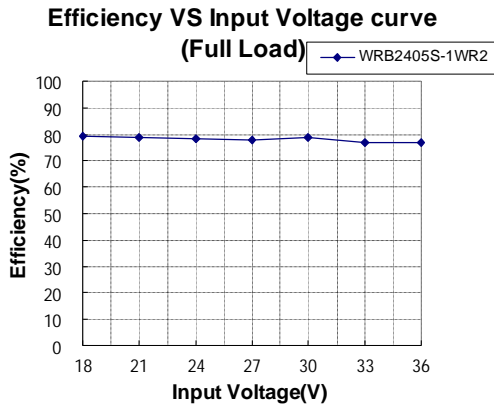

OUTLINE DIMENSIONS, RECOMMENDED FOOTPRINT & PACKAGING

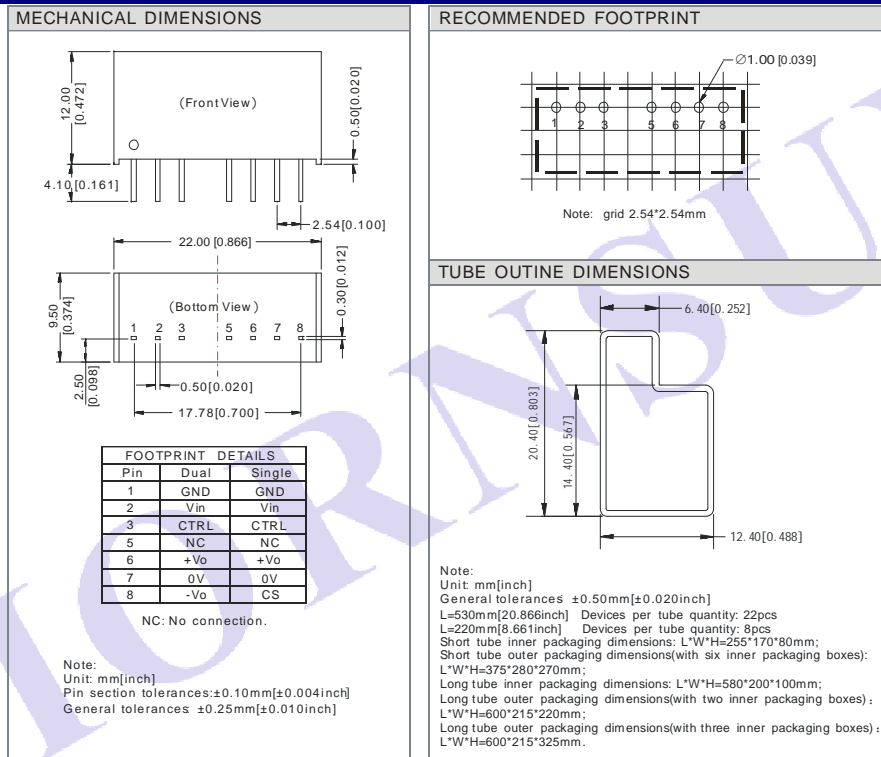

TEST CONFIGURATIONS

Input Reflected-Ripple Current Test Setup

Input reflected-ripple current is measured with an inductor L_{in} and Capacitor C_{in} to simulate source impedance.

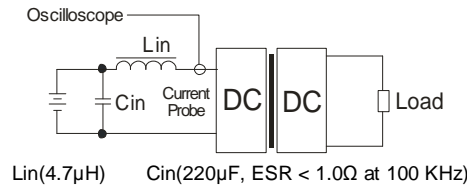

DESIGN CONSIDERATIONS

1) Requirement on output load

To ensure this module can operate efficiently and reliably, During operation, the minimum output load could not be less than 5% of the full load. otherwise ripple may increase dramatically. If the actual output power is very small, please connect a resistor with proper resistance at the output end in parallel to increase the load, suppose to use the resistance of 5% rated power, or use our company's products with a lower rated output power.

2) Recommended Circuit

All the WRA_S-1WR2 & WRB_S-1WR2 series have been tested according to the following recommended testing circuit before leaving factory. This series should be tested under load (See Figure 5).

If you want to further decrease the input/output ripple, you can increase capacitance properly or choose capacitors with low ESR. However, the capacitance of the output filter capacitor must be proper. If the capacitance is too big, a startup problem might arise. For every channel of output, provided the safe and reliable operation is ensured, the greatest capacitance must less than the Max. Capacitive Load.

General: Cin: 5V&12V 100μF
 24V&48V 10μF
 Lin: 4.7μH~120μH
 Cs: 10μF~22μF
 Cout: 100μF(Typ.)
 Lout: 2.2μH~10μH
 Cd: 47nF/100V

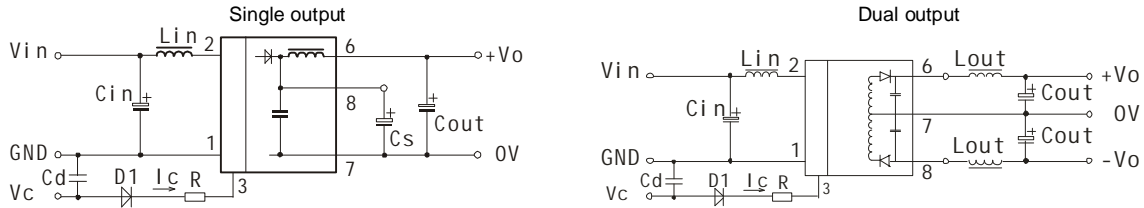

(Figure 5)

3) CTRL Terminal

When open or high impedance, the converter work well; When this pin is 'high'; the converter shutdown; It should be note that the input current should between 5-10mA,exceeding the maximum 20mA will cause permanence damage to the converter. The value of R can be derived as follows:

$$R = \frac{V_c - V_D - 1.0}{I_c} - 300$$

4) Input Current

When it is used in unregulated power supply, be sure that the fluctuating range of the power supply and the rippled voltage do not exceed the module standard. Input current of power supply should afford the flash startup current of this kind of DC/DC module (Figure 6).

General: Vin=5V Ip =490mA
 Vin=12V Ip =230mA
 Vin=24V Ip =110mA
 Vin=48V Ip =53 mA

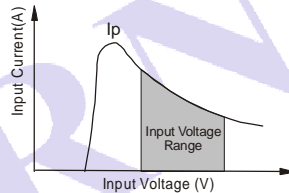

(Figure 6)

5) Cannot use in parallel and hot swap

Note:

1. Min. load shouldn't be less than 5%, otherwise ripple maybe increase dramatically. Operation under minimum load will not damage the converter, however, they may not meet all specification listed.
2. Max. Capacitive Load is tested at input voltage range and full load.
3. All specifications are measured at Ta=25°C, humidity<75%, nominal input voltage and rated output load unless otherwise specified.
4. In this datasheet, all the test methods of indications are based on our corporate standards.
5. All characteristics are for listed model, non-standard models may perform differently, please contact our technical person for more detail.
6. Contact us for your specific requirement.
7. Specifications subject to change without prior notice.

MORNSUN Science & Technology Co.,Ltd.

Address: No. 5, Kehui St. 1, Kehui development center, Science Ave., Guangzhou Science City, Luogang district, Guangzhou,P.R.China.

Tel: 86-20-28203030

Fax:86-20-38601272

[Http://www.mornsun-power.com](http://www.mornsun-power.com)