

Small Signal Schottky Diode



SOT-23

Features

- Epoxy meets UL-94 V-0 flammability rating and halogen free
- Moisture Sensitivity Level 1
- Low Forward Voltage Schottky Rectifier
- V_{RRM} 40V
- I_{FAV} 0.12A
- Part no. with suffix "Q" means AEC-Q101 qualified

Applications

- Ultra high speed switching
- Voltage clamping

Mechanical Data

- **Case:** SOT-23
- **Terminals:** Tin plated leads, solderable per J-STD-002 and JESD22-B102

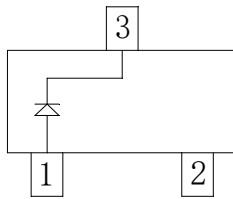

BAS40Q
Marking:43

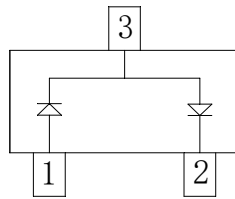

BAS40-04Q
Marking:44

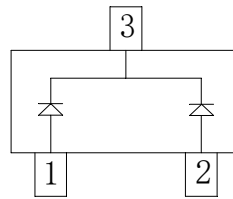

BAS40-05Q
Marking:45

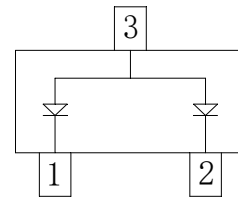

BAS40-06Q
Marking:46

■ Maximum Ratings ($T_a=25^\circ\text{C}$ Unless otherwise specified)

PARAMETER	SYMBOL	UNIT	CONDITIONS	VALUE
Peak Repetitive Reverse Voltage	V_{RRM}	V		40
Average Forward Current	I_{FAV}	mA		120
Non-repetitive Peak Forward Surge Current	I_{FSM}	A	square wave $t_p < 10\text{ms}$	0.6
Power Dissipation	P_D	mW		200
Thermal Resistance Junction to Ambient	R_{thJA}	$^\circ\text{C}/\text{W}$		500
Junction Temperature	T_j	$^\circ\text{C}$		-55 to +125
Storage Temperature Range	T_{stg}	$^\circ\text{C}$		-55 to +150



BAS40Q/BAS40-04Q/BAS40-05Q/BAS40-06Q

■ Electrical Characteristics (T_a=25°C Unless otherwise specified)

PARAMETER	SYMBOL	UNIT	CONDITIONS	MIN	MAX
Reverse Breakdown Voltage	V _{(BR)R}	V	I _R =10uA	40	
Forward Voltage	V _F	V	I _F =1.0mA	-	0.38
			I _F =40mA	-	1.0
Reverse Current	I _R	μA	V _R =30V	-	0.2
Junction Capacitance	C _J	pF	V _R =0 V, f =1MHz	-	5
Reverse Recovery Time	t _{rr}	ns	I _F =I _R =5mA, I _{tr} =0.5mA, R _L =100Ω	-	5

■ Ordering Information (Example)

PREFERRED P/N	PACKING CODE	UNIT WEIGHT(g)	MINIMUM PACKAGE(pcs)	INNER BOX QUANTITY(pcs)	OUTER CARTON QUANTITY(pcs)	DELIVERY MODE
BAS40Q/BAS40-04Q/BAS40-05Q/BAS40-06Q	F2	Approximate 0.01	3000	30000	120000	7" reel

■ Characteristics(Typical)

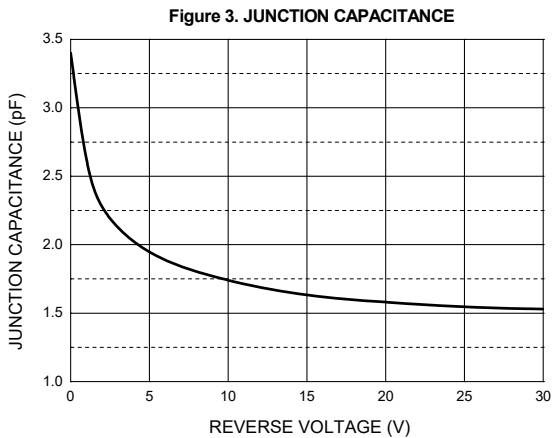
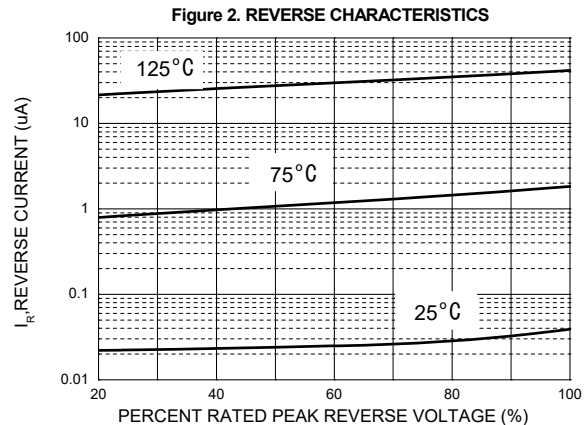
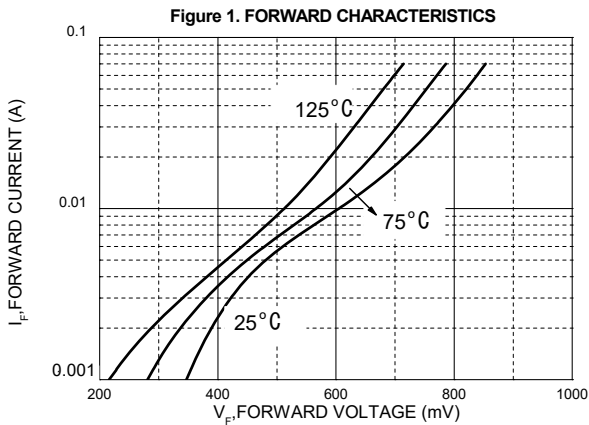



BAS40Q/BAS40-04Q/BAS40-05Q/BAS40-06Q

■ SOT-23 Package Outline Dimensions

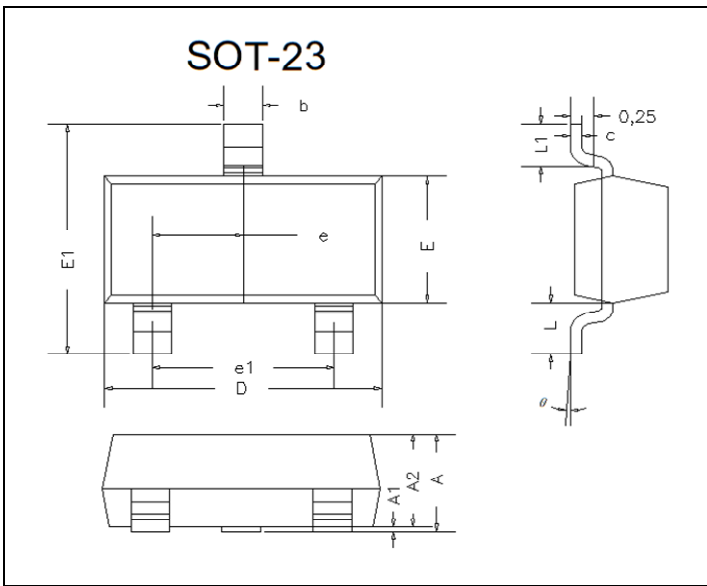

DIM	INCHES		MM		NOTE
	MIN	MAX	MIN	MAX	
A	0.035	0.045	0.90	1.15	
A1	0.000	0.004	0.00	0.10	
A2	0.035	0.041	0.90	1.05	
b	0.012	0.020	0.30	0.50	
c	0.004	0.008	0.10	0.20	
D	0.110	0.118	2.80	3.00	
E	0.047	0.055	1.20	1.40	
E1	0.089	0.100	2.25	2.55	
e	0.370TYP		0.95TYP		
e1	0.071	0.079	1.80	2.00	
L	0.220REF		0.55REF		
L1	0.012	0.020	0.30	0.50	
θ	0°	8°	0°	8°	

■ SOT-23 Suggested Pad Layout

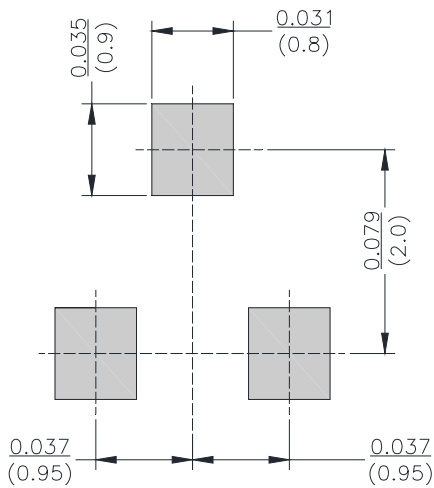

Unit: $\frac{\text{inch}}{\text{mm}}$



Disclaimer

The information presented in this document is for reference only. Yangzhou Yangjie Electronic Technology Co., Ltd. reserves the right to make changes without notice for the specification of the products displayed herein to improve reliability, function or design or otherwise.

The product listed herein is designed to be used with automotive electronics, are not designed for use in medical, life-saving, lifesustaining, or military, Yangjie or anyone on its behalf, assumes no responsibility or liability for any damages resulting from such improper use of sale.

This publication supersedes & replaces all information previously supplied. For additional information, please visit our website [http:// www.21yangjie.com](http://www.21yangjie.com) , or consult your nearest Yangjie's sales office for further assistance.