



Wincom Tech CO., LTD.

The LCD(M) Specialist

CONTACT ADDRESS: 6F, Block 105, Jing Di Industrial Park,
Fu Qiang Rd. Fu Tian, Shenzhen City, China.

Tel: 0086-755-83308729

Fax: 0086-755-83308659

E-mail: craig.jiang@wincomlcd.com



RoHS

PART NO. : WG12864D V1.0
 -FFPLWHTC06

FOR MESSRS. : _____

CONTENTS

<i>NO.</i>	<i>ITEM</i>	<i>PAGE</i>
1.	COVER	1
2.	RECORD OF REVISION	2
3.	GENERAL SPECIFICATION	3
4.	MECHANICAL DATA	3
5.	ABSOLUTE MAXIMUM RATINGS	4
6.	ELECTRICAL CHARACTERISTICS	5
7.	OPTICAL CHARACTERISTICS	5
8.	OUTLINE DIMENSION	6~7
9.	BLOCK DIAGRAM	7
10	INTERFACE TIMING CHART	8-9
11	INSTRUCTION CODE	10
12	SPECIFICATION OF QUALITY ASSURANCE	11~15

ACCEPTED BY: _____

PROPOSED BY: _____

RECORD OF REVISION

DATE	PAGE	SUMMARY

3. General specifications

3.1 General specifications

PLEASE REFER TO:

“CUSTOMER ACCEPTANCE STANDARD SPECIFICATIONS (MS-10-10000)”.

3.2 Quality Assurance and Warranty

PLEASE REFER TO:

“QUALITY ASSURANCE MANUL (MS-10-10001)”.

3.3 This individual specification is prior to general specifications

4. Mechanical data

- Display format: 128 x 64 DOTS
- LCD type: FSTN Positive , Transflective
- Backlight color: White, LED
- Viewing angle: 6:00
- Data transfer: 8Bit Parallel
- LCD controller: S6B0108
- Module size: 75x53 mm
- View area: 60 x 32.4 mm
- Dot size: 0.4 x 0.4 mm
- Dot pitch: 0.43 x 0.43mm
- Driving method: 1/64duty, 1/9 bias

5. Absolute maximum ratings

5.1 Electrical absolute maximum ratings

<i>I T E M</i>	<i>SYMBOL</i>	<i>MIN.</i>	<i>MAX.</i>	<i>UNIT</i>	<i>COMMENT</i>
POWER SUPPLY FOR LOGIC	V _{DD} -V _{SS}	-0.3	5.5	V	-----
INPUT VOLTAGE	V _I	V _{SS}	V _{DD}	V	-----
STATIC ELECTRICITY	-----	-----	-----	V	-----
POWER SUPPLY FOR BACKLIGHT	V _S	-0.3	3.3	V _{rms}	-----
	f _{FL}	-----	-----	KHz	-----
STARTING VOLTAGE FOR BACKLIGHT	-----	-----	-----	V _{rms}	Ta = 25°C
	-----	-----	-----	V _{rms}	Ta = 25°C
POWER SUPPLY FOR LCD	V _{lcd}	-----	10.2	V	-----

5.2 Environmental absolute maximum ratings

<i>I T E M</i>	<i>OPERATING</i>		<i>STORAGE</i>		<i>COMMENT</i>
	<i>MIN.</i>	<i>MAX.</i>	<i>MIN.</i>	<i>MAX.</i>	
AMBIENT TEMPERATURE	-20°C	70°C	-30°C	80°C	-----
HUMIDITY	NOTE (2)		NOTE (2)		NO CONDENSATION
VIBRATION NOTE (3)	-----	0.5G	-----	2G	10~300Hz XYZ DIRECTIONS 1 Hr EACH
SHOCK NOTE (3)	-----	3G	-----	5G	10 msec XYZ DIRECTIONS 1 TIME EACH
CORROSIVE GAS	NOT ACCEPTABLE		NOT ACCEPTABLE		-----

NOTE (2): Ta ≦ 70°C: 75% RH MAX.

Ta > 70°C: ABSOLUTE HUMIDITY MUST BE LOWER THAN THE HUMIDITY OF
75% RH AT 70°C.

NOTE (3): 1G = 9.8 m/s²

6. Electrical characteristics

Ta = 25°C VDD = 5.0V

<i>I T E M</i>	<i>SYMBOL</i>	<i>CONDITION</i>	<i>MIN.</i>	<i>TYP.</i>	<i>MAX.</i>	<i>UNIT</i>
Power supply voltage for circuit	VDD-VSS	-----	4.8	5.0	5.25	V
Power supply voltage for LCD drive	VDD-VEE	-----	-----	9.0	-----	V
Data input voltage	V _{IH}	H LEVEL	2.4	-----	V _{DD}	V
	V _{IL}	L LEVEL	-0.3	-----	0.4	V
LCD display duty ratio	DUTY	-----	-----	1/64	-----	-----
LED BACKLIGHT	I _{fp}	I mse0 plus 10% Dutg cycle		--		mA
		Operating voltage	3.0	3.1	3.2	V
		Forward current		60	80	mA
LED Lifetime	-----	V _{FL} = 3.1Vrms f _{FL} = KHZ	-----	100,000	-----	Hr

NOTE: LED backlight: Due to the LED backlight working current is XXX Max,and LED chips Vop may be different, Wincom will adjust the backlight resistor according to the LED chips Vop, to meet the brightness maximum.

7. Optical characteristics

Ta = 25°C VLCD = 9.0V

<i>I T E M</i>	<i>SYMBOL</i>	<i>CONDITION</i>	<i>MIN.</i>	<i>TYP.</i>	<i>MAX.</i>	<i>UNIT</i>	<i>NOTE</i>
Viewing angle	Φ2-Φ1	K ≥ 2.0	-35	-----	20	deg.	1
Contrast ratio	K	Φ = 10° θ = 0°	4.0	-----	-----	-----	1
Response time (at 25°C)	tr (rise)	Φ = 10° θ = 0°	-----	-----	250	ms	1
	tf (fall)	Φ = 10° θ = 0°	-----	-----	250	ms	1
The brightness of backlighting source	B	V _{FL} = 3.1Vrms f _{FL} = KHZ	-----	250	-----	cd/m ²	2

NOTE (1): SEE CUSTOMER ACCEPTANCE STANDARD SPECIFICATION FOR DEFINITION OF OPTICAL CHARACTERISTICS

NOTE (2): UNDER NORMAL TEMPERATURE AND HUMIDITY IN A DARK ROOM

8. Outline dimension

Customer:	Product Model:	Customer Approve By:	REV.	DESCRIPTION OF MODIFY	DATE 2007/10/12日
-----------	----------------	----------------------	------	-----------------------	---------------------

The drawing includes the following dimensions and features:

- Top View:** Overall width 68±0.3, overall height 75±0.5. Internal width 50.5, internal height 70. A hole is located at 25.5±0.5 from the left edge and 20 from the bottom edge. A chamfered corner is shown with a 4-φ2.5 chamfer. A row of 19 holes is located 55.01 from the bottom edge with a pitch of 2.54x19=48.26. Other dimensions include 3±0.5, 27.49, 33.4, 45±0.3, 53±0.5, and 2.5.
- Side View:** Overall height 60, top thickness 1.2, bottom thickness 5.3, and a maximum depth of 9.5 MAX.
- Detail View:** Shows a 2x2 grid of holes with a pitch of 0.4 and a hole diameter of 0.03.
- Bottom View:** Shows a width of 6.5 and a depth of 3.7±0.3.

umark tolerance: ±0.2

DRAWN BY :	CHECKED BY :	TEL: <0755>83308729	FAX: <0755>83308659	E:raig.jiang@wincomlcd.com
WINCOM TECH				
UNITS MM	TITIL	REV:	DWG NO. :WG12864D	
		SCALE:		

8.2 Interface

Pin Assignment

PIN NO.	Symbol	Level	Function
1	VDD	5.0V	Power supply for logic circuit
2	Vss	0V	Ground
3	V0	----	Contrast Adjust
4	DB0	H/L	Data Bus Line
5	DB1	H/L	Data Bus Line
6	DB2	H/L	Data Bus Line
7	DB3	H/L	Data Bus Line
8	DB4	H/L	Data Bus Line
9	DB5	H/L	Data Bus Line
10	DB6	H/L	Data Bus Line
11	DB7	H/L	Data Bus Line
12	CS1	H/L	Chip Selection Signal 1 (Active " Low")
13	CS2	H/L	Chip Selection Signal 2 (Active " Low")
14	RST	H/L	Reset (Active " Low")
15	RW	H/L	Data read / write
16	RS	H/L	Register select signal
17	E	H/L	Enable signal
18	Vout	-5V	Output Voltage for LCD Driving
19	A	(+5.0v)	Power supply for BL LED(+)
20	K	(-)	Power supply for BL LED(-)

9 Block diagram

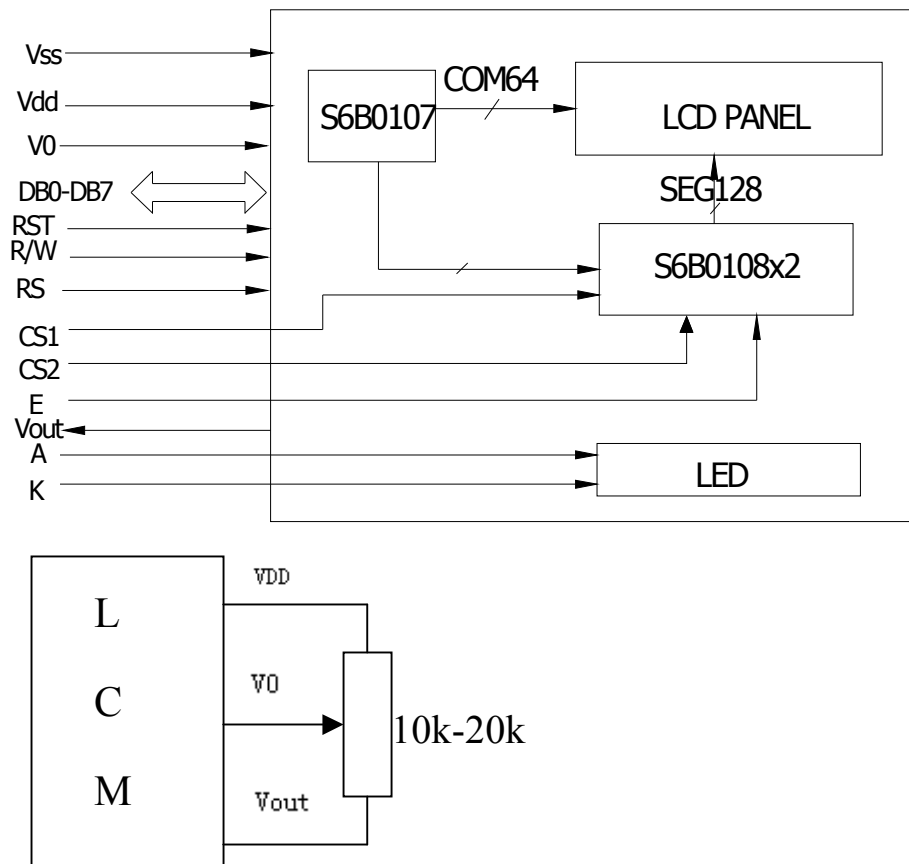

10. Interface Timing Chart

Characteristic	Symbol	Min	Typ	Max	Unit
E Cycle	t_C	1000	-	-	ns
E High Level Width	t_{WH}	450	-	-	ns
E Low Level Width	t_{WL}	450	-	-	ns
E Rise Time	t_R	-	-	25	ns
E Fall Time	t_F	-	-	25	ns
Address Set-Up Time	t_{ASU}	140	-	-	ns
Address Hold Time	t_{AH}	10	-	-	ns
Data Set-Up Time	t_{DSU}	200	-	-	ns
Data Delay Time	t_D	-	-	320	ns
Data Hold Time (Write)	t_{DHW}	10	-	-	ns
Data Hold Time (Read)	t_{DHR}	20	-	-	ns

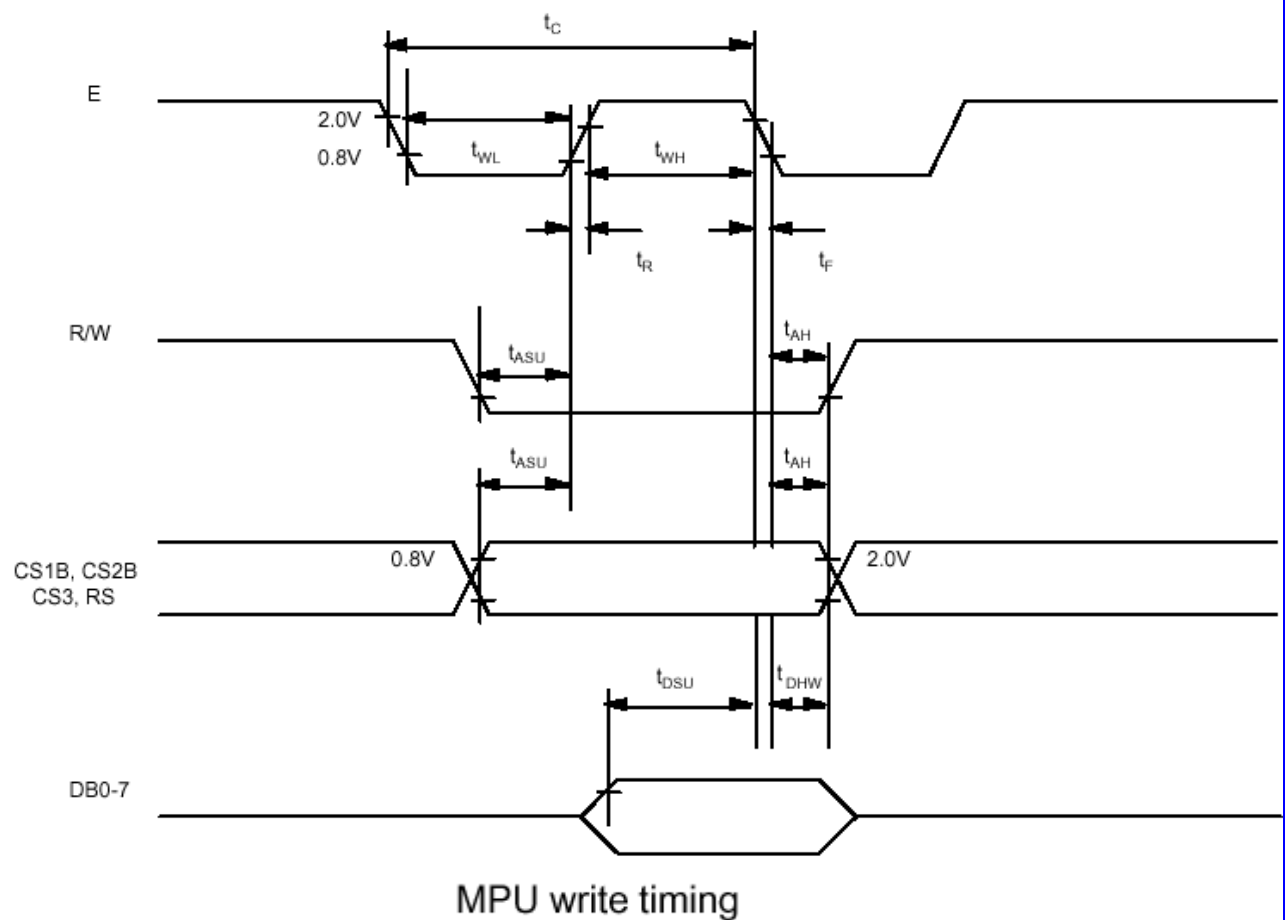

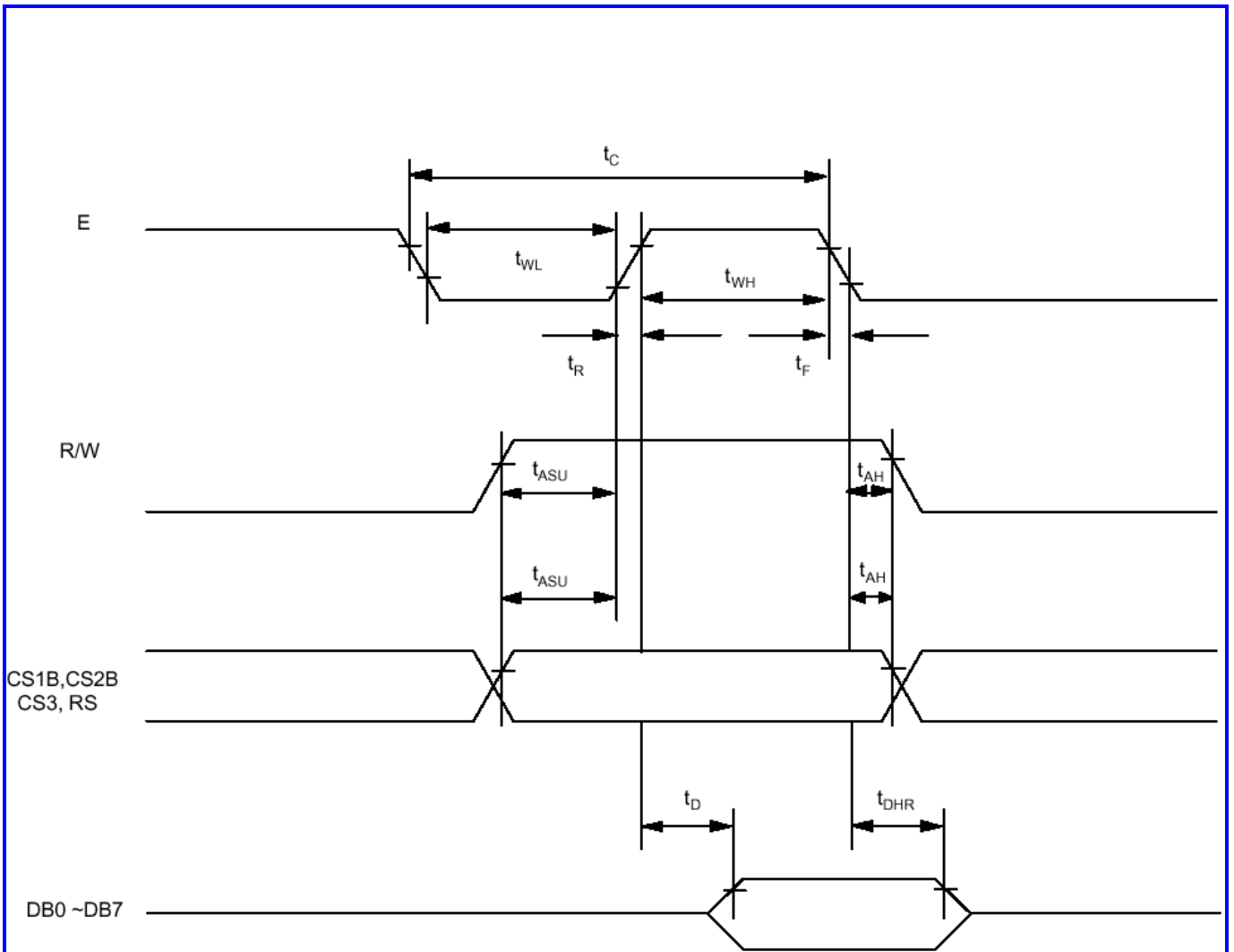

. MPU Read timing

11. Instruction Code

Instruction	RS	R/W	DB7	DB6	DB5	DB4	DB3	DB2	DB1	DB0	Function	
Display ON/OFF	L	L	L	L	H	H	H	H	H	L/H	Controls the display on or off. Internal status and display RAM data is not affected. L:OFF, H:ON	
Set Address (Y address)	L	L	L	H	Y address (0~63)						Sets the Y address in the Y address counter.	
Set Page (X address)	L	L	H	L	H	H	H	Page (0~7)			Sets the X address at the X address register.	
Display Start Line (Z address)	L	L	H	H	Display start line (0~63)						Indicates the display data RAM displayed at the top of the screen.	
Status Read	L	H	B U S Y	L	O N / O F F	R E S E T	L	L	L	L	Read status. BUSY L: Ready H: In operation ON/OFF L: Display ON H: Display OFF RESET L: Normal H: Reset	
Write Display Data	H	L	Write Data									Writes data (DB0:7) into display data RAM. After writing instruction, Y address is increased by 1 automatically.
Read Display Data	H	H	Read Data									Reads data (DB0:7) from display data RAM to the data bus.

12. Specification of quality assurance



AQL inspection standard

Sampling method: MIL-STD-105E, Level II, single sampling

Defect classification (**Note: * is not including**)

Classify	Item	Note	AQL	
Major	Display state	Short or open circuit	1	0.65
		LC leakage		
		Flickering		
		No display		
		Wrong viewing direction		
		Contrast defect (dim, ghost)		
	Back-light	1,8		
	Non-display	Flat cable or pin reverse	10	
		Wrong or missing component	11	
Minor	Display state	Background color deviation	2	1.0
		Black spot and dust	3	
		Line defect, Scratch	4	
		Rainbow	5	
		Chip	6	
		Pin hole	7	
	Polarizer	Protruded	12	
		Bubble and foreign material	3	
	Soldering	Poor connection	9	
	Wire	Poor connection	10	
	TAB	Position, Bonding strength	13	

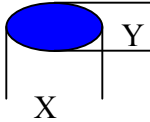
Note on defect classification

No.	Item	Criterion			
1	Short or open circuit	Not allow			
	LC leakage				
	Flickering				
	No display				
	Wrong viewing direction				
	Wrong Back-light				
2	Contrast defect	Refer to approval sample			
	Background color deviation				
3	Point defect, Black spot, dust (including Polarizer) $\phi = (X+Y)/2$		Point Size	Acceptable Qty.	
			$\phi < 0.10$	Disregard	
			$0.10 < \phi \leq 0.20$	3	
			$0.20 < \phi \leq 0.25$	2	
			$0.25 < \phi \leq 0.30$	1	
			$\phi > 0.30$	0	
Unit:mm					
4	Line defect, Scratch		Line		Acceptable Qty.
			L	W	
			---	$0.015 \geq W$	2
			$3.0 \geq L$	$0.03 \geq W$	
			$2.0 \geq L$	$.05 \geq W$	1
			$1.0 \geq L$	$0.1 > W$	
---	$0.05 < W$	Applied as point defect			
5	Rainbow	Not more than two color changes across the viewing area.			

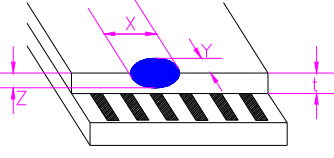
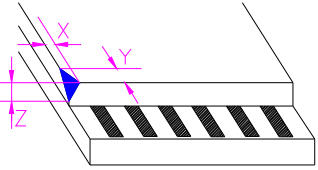
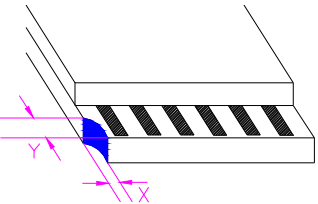
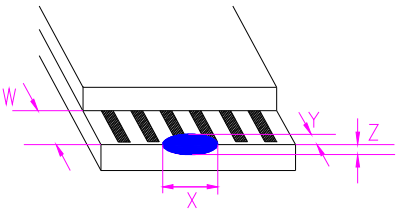
NO.	Item	Criterion																																							
6	<p>Chip</p> <p>Remark:</p> <p>X: Length direction</p> <p>Y: Short direction</p> <p>Z: Thickness direction</p> <p>t: Glass thickness</p> <p>W: Terminal Width</p>	 <table border="1" data-bbox="1029 376 1489 526"> <thead> <tr> <th colspan="3">Acceptable criterion</th> </tr> <tr> <th>X</th> <th>Y</th> <th>Z</th> </tr> </thead> <tbody> <tr> <td>≤ 2</td> <td>0.5mm</td> <td>$\leq t/2$</td> </tr> </tbody> </table>  <table border="1" data-bbox="1029 728 1489 878"> <thead> <tr> <th colspan="3">Acceptable criterion</th> </tr> <tr> <th>X</th> <th>Y</th> <th>Z</th> </tr> </thead> <tbody> <tr> <td>≤ 2</td> <td>0.5mm</td> <td>$\leq t$</td> </tr> </tbody> </table>  <table border="1" data-bbox="1029 1012 1489 1254"> <thead> <tr> <th colspan="3">Acceptable criterion</th> </tr> <tr> <th>X</th> <th>Y</th> <th>Z</th> </tr> </thead> <tbody> <tr> <td>≤ 3</td> <td>≤ 2</td> <td>$\leq t$</td> </tr> <tr> <td colspan="2">shall not reach to ITO</td> <td></td> </tr> </tbody> </table>  <table border="1" data-bbox="1029 1680 1489 1830"> <thead> <tr> <th colspan="3">Acceptable criterion</th> </tr> <tr> <th>X</th> <th>Y</th> <th>Z</th> </tr> </thead> <tbody> <tr> <td>Disregard</td> <td>≤ 0.2</td> <td>$\leq t$</td> </tr> </tbody> </table>	Acceptable criterion			X	Y	Z	≤ 2	0.5mm	$\leq t/2$	Acceptable criterion			X	Y	Z	≤ 2	0.5mm	$\leq t$	Acceptable criterion			X	Y	Z	≤ 3	≤ 2	$\leq t$	shall not reach to ITO			Acceptable criterion			X	Y	Z	Disregard	≤ 0.2	$\leq t$
Acceptable criterion																																									
X	Y	Z																																							
≤ 2	0.5mm	$\leq t/2$																																							
Acceptable criterion																																									
X	Y	Z																																							
≤ 2	0.5mm	$\leq t$																																							
Acceptable criterion																																									
X	Y	Z																																							
≤ 3	≤ 2	$\leq t$																																							
shall not reach to ITO																																									
Acceptable criterion																																									
X	Y	Z																																							
Disregard	≤ 0.2	$\leq t$																																							

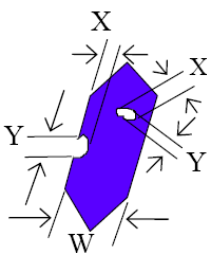
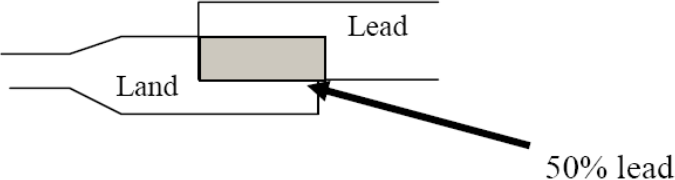
No.	Item	Criterion								
7	Segment pattern $W = \text{Segment width}$ $\phi = (X+Y)/2$	(1) Pin hole $\phi < 0.10\text{mm}$ is acceptable.  <table border="1" data-bbox="1029 313 1468 481"> <thead> <tr> <th>Point Size</th> <th>Acceptable Qty</th> </tr> </thead> <tbody> <tr> <td>$\phi \leq 1/4W$</td> <td>Disregard</td> </tr> <tr> <td>$1/4W < \phi \leq 1/2W$</td> <td>1</td> </tr> <tr> <td>$\phi > 1/2W$</td> <td>0</td> </tr> </tbody> </table> <p style="text-align: right;">Unit: mm</p>	Point Size	Acceptable Qty	$\phi \leq 1/4W$	Disregard	$1/4W < \phi \leq 1/2W$	1	$\phi > 1/2W$	0
Point Size	Acceptable Qty									
$\phi \leq 1/4W$	Disregard									
$1/4W < \phi \leq 1/2W$	1									
$\phi > 1/2W$	0									
8	Back-light	(1) The color of backlight should correspond its specification. (2) Not allow flickering								
9	Soldering	(1) Not allow heavy dirty and solder ball on PCB. (The size of dirty refer to point and dust defect) (2) Over 50% of lead should be soldered on Land. 								
10	Wire	(1) Copper wire should not be rusted (2) Not allow crack on copper wire connection. (3) Not allow reversing the position of the flat cable. (4) Not allow exposed copper wire inside the flat cable.								
11*	PCB	(1) Not allow screw rust or damage. (2) Not allow missing or wrong putting of component.								

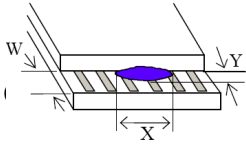
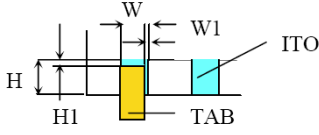
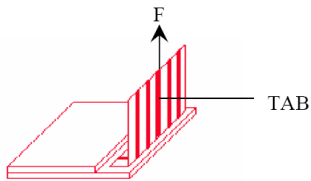
NO.	Item	Criterion
12	Protruded W: Terminal Width	 <p style="text-align: right;">Acceptable</p> <p style="text-align: right;">$Y \leq 0.4$</p>
13	TAB	<p>1. Position</p>  <p style="text-align: right;">$W1 \leq 1/3W$ $H1 \leq 1/3H$</p> <p>2 TAB bonding strength test</p>  <p>$P (=F/TAB \text{ bonding width}) \geq 650\text{gf/cm}$, (speed rate: 1mm/min) 5pcs per SOA (shipment)</p>
14	Total no. of acceptable Defect	<p>A. Zone Maximum 2 minor non-conformities per one unit. Defect distance: each point to be separated over 10mm</p> <p>B. Zone It is acceptable when it is no trouble for quality and assembly in customer's end product.</p>