

503SIRC2H-5AE

5mm, Infrared Emitting diode
Round With Flange Type

Technical Data Sheet

Features:

- High reliability.
- General purpose leads.
- Bulk, Available on tape and reel.
- General purpose leads.
- Peak wavelength $\lambda_p=850\text{nm}$.
- Low forward voltage.
- High radiant intensity.
- Compliance with EU REACH.
- The product itself will remain within RoHS compliant Version.

Descriptions:

- The device is spectrally matched with phototransistor , photodiode and infrared receiver module.
- The Infrared Emitting Diode (SIR series) is a high intensity diode , molded in a water clear plastic package.

Applications:

- Optoelectronic switch.
- IR Touch-Panel.
- Industrial IR equipment.
- Consumer Electronics.
- High Speed IR Communications.

Device Selection Guide

Part No.	Emitting Color	Lens Color
503SIRC2H-5AE	Infrared	Water Clear

503SIRC2H-5AE

5mm, Infrared Emitting diode
Round With Flange Type

Technical Data Sheet

Package Dimension:

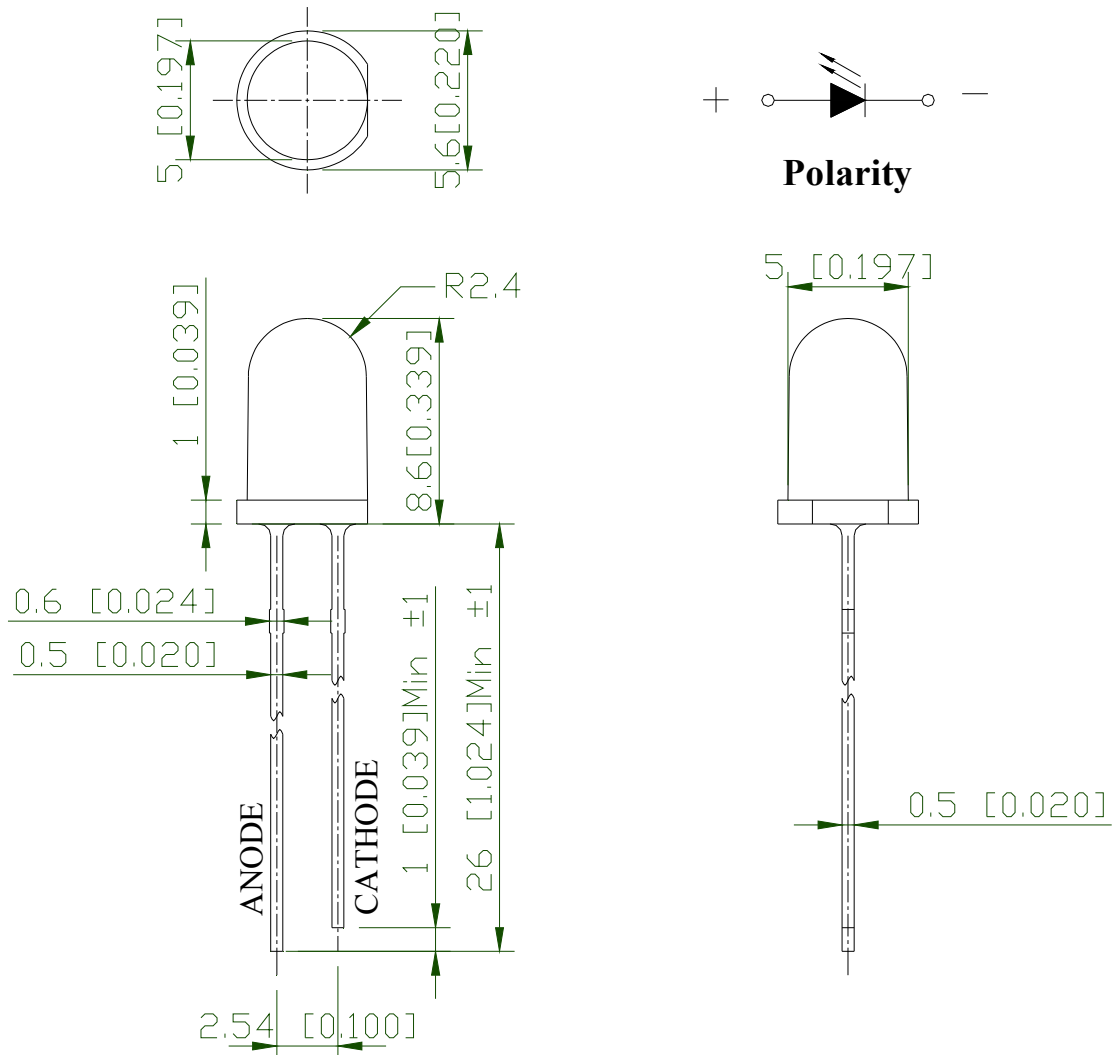

Notes:

1. All dimensions are in millimeters (inches).
2. Tolerance is ± 0.25 mm (.010") unless otherwise noted.
3. Protruded resin under flange is 1.00mm (.039") max.

503SIRC2H-5AE

5mm, Infrared Emitting diode
Round With Flange Type

Technical Data Sheet

Absolute Maximum Ratings at Ta=25°C

Parameters	Symbol	Max.	Unit
Power Dissipation	P_d	150	mW
Peak Forward Current ^(a)	I_{FP}	1	A
DC Forward Current ^(b)	I_F	100	mA
Reverse Voltage	V_R	5	V
Operating Temperature Range	T_{opr}	-40°C to +80°C	
Storage Temperature Range	T_{stg}	-40°C to +85°C	
Soldering Temperature	T_{sld}	260°C for 5 Seconds	

Notes:

- a. Derate linearly as shown in derating curve.
- b. Duty Factor = 10%, Frequency = 1 kHz.

Electrical Optical Characteristics at Ta=25°C

Parameters	Symbol	Min.	Typ.	Max.	Unit	Test Condition
Radiant Intensity	E_e	10	16	---	mW/sr	IF=20mA
		20	45	---		IF =50mA
Viewing Angle ^(a)	$2\theta_{1/2}$	---	45	---	deg.	IF=20mA
Peak Emission Wavelength	λ_p	---	850	---	nm	IF=20mA
Spectral Line Half-Width	$\Delta\lambda$	---	45	---	nm	IF=20mA
Forward Voltage	VF	1.00	1.40	1.60	V	IF=20mA
		1.20	1.50	1.80		IF=50mA
Reverse Current	IR	---	---	10	μ A	VR=5V

Notes:

- a. $\theta_{1/2}$ is the off-axis angle at which the luminous intensity is half the axial luminous intensity.

503SIRC2H-5AE

5mm, Infrared Emitting diode
Round With Flange Type



Technical Data Sheet

Typical Electrical / Optical Characteristics Curves (25°C Ambient Temperature Unless Otherwise Noted)

Forward Current & Ambient Temperature

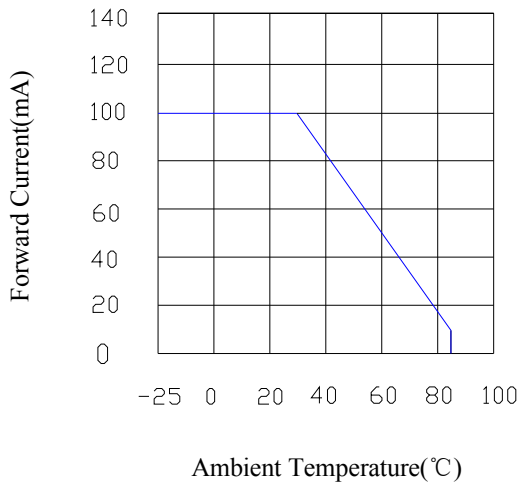

Spectral Distribution

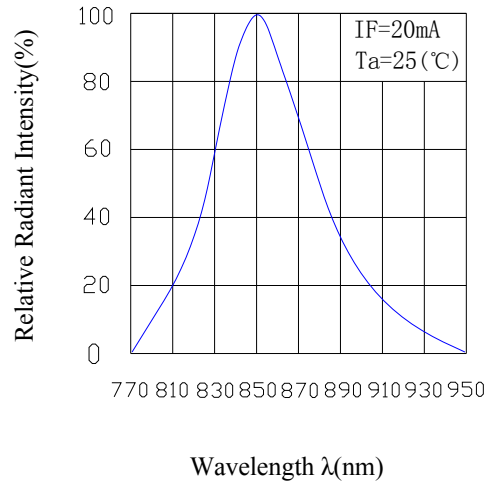

Peak Emission Wavelength & Ambient Temperature

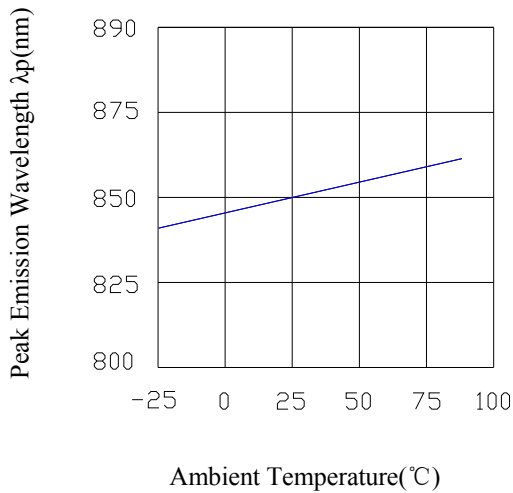

Forward Current & Forward Voltage

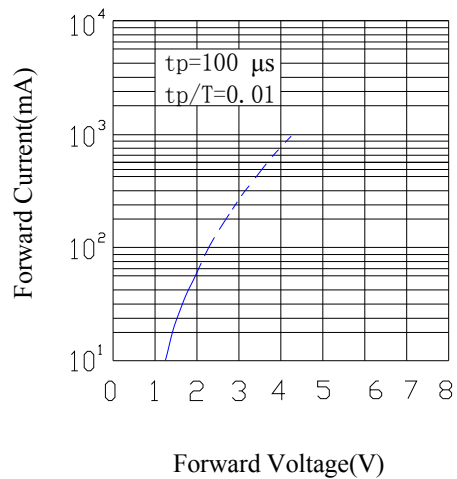

503SIRC2H-5AE

5mm, Infrared Emitting diode
Round With Flange Type

Technical Data Sheet

Relative Intensity & Forward Current

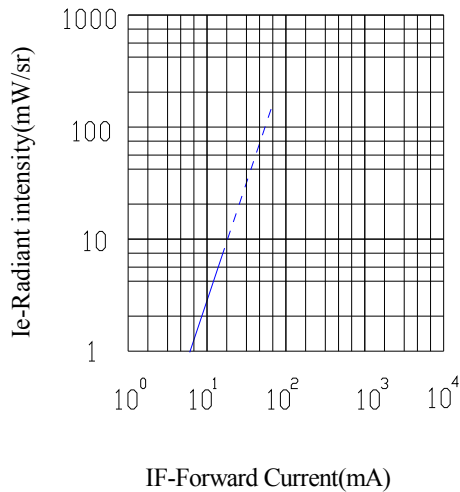

Relative Radiant Intensity & Angular Displacement

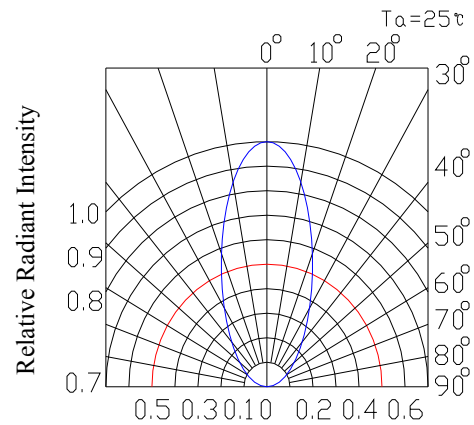

Relative Intensity & Ambient Temperature

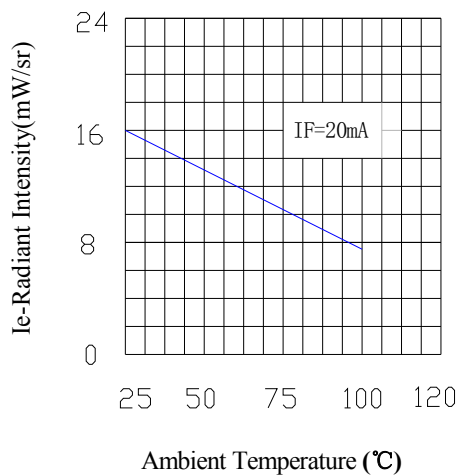

Forward Voltage & Ambient Temperature

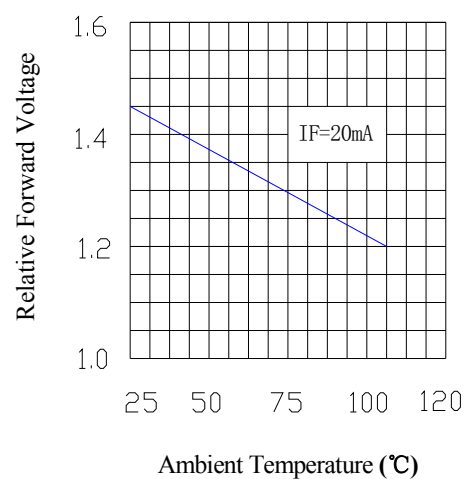

503SIRC2H-5AE

5mm, Infrared Emitting diode
Round With Flange Type



Technical Data Sheet

Packing & Label Specifications:

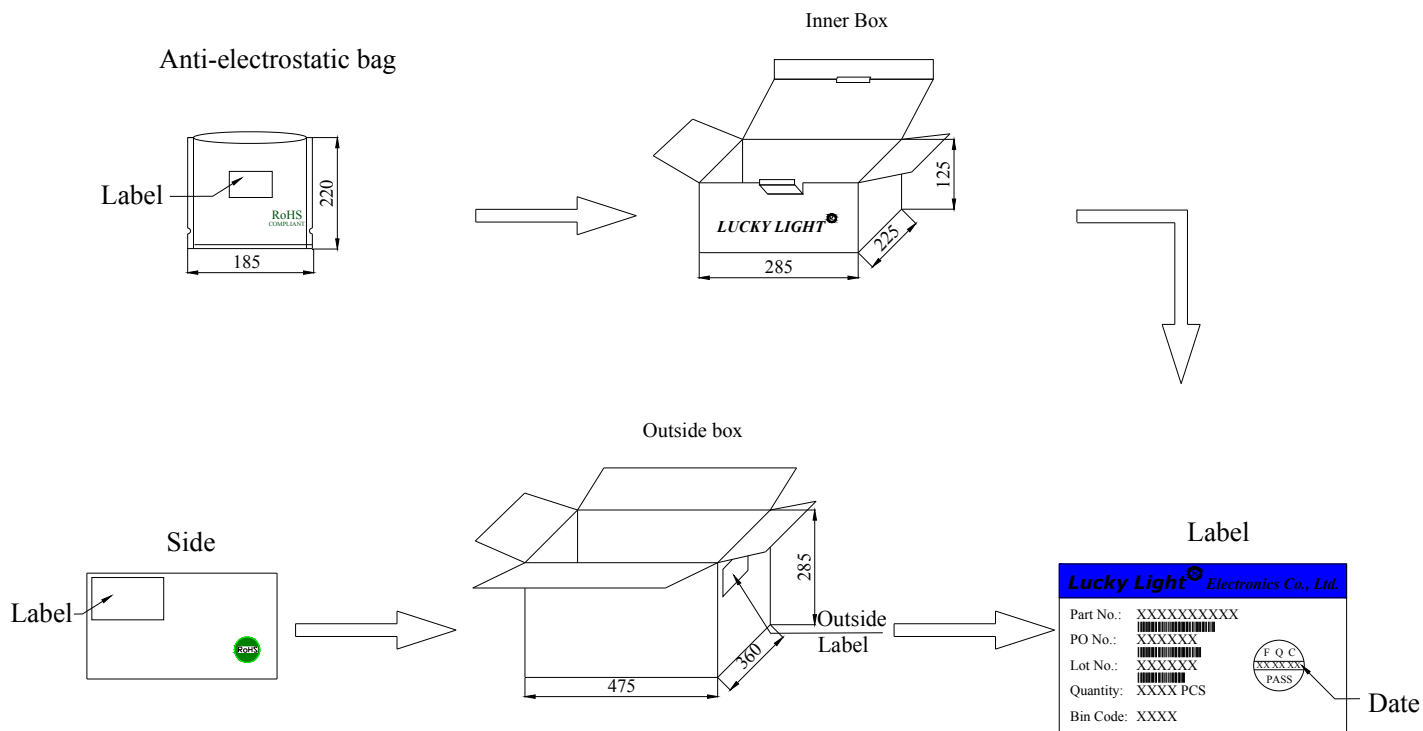

Packing Quantity:

- a. 1000 PCS/bag.
- b. 10000 PCS/Inner Box.
- c. 6 Inner Boxes/Outside Box.

503SIRC2H-5AE

5mm, Infrared Emitting diode
Round With Flange Type



Technical Data Sheet

CAUTIONS

1. Over-current-proof

Customer must apply resistors for protection, otherwise slight voltage shift will cause big current change (Burn out will happen).

2. Storage

2.1 The LEDs should be stored at 30°C or less and 70%RH or less after being shipped from LuckyLight and the storage life limits are 3 months. If the LEDs are stored for 3 months or more, they can be stored for a year in a sealed container with a nitrogen atmosphere and moisture absorbent material.

2.2 Please avoid rapid transitions in ambient temperature, especially, in high humidity environments where condensation can occur.

3. Cleaning

Use alcohol-based cleaning solvents such as isopropyl alcohol to clean the LEDs if necessary.

4. Lead Forming & Assembly

During lead forming, the leads should be bent at a point at least 1.6mm from the base of LED lens. Do not use the base of the lead frame as a fulcrum during forming. Lead forming must be done before soldering, at normal temperature. During assembly on PCB, use minimum clinch force possible to avoid excessive mechanical stress.

5. Soldering

When soldering, for Lamp without stopper type and must be leave a minimum of 3mm clearance from the base of the lens to the soldering point. Do not apply any external stress to the lead frame during soldering while the LED is at high temperature.

Recommended soldering conditions:

Soldering Iron		Wave Soldering	
Temperature	300°C Max.	Pre-heat	100°C Max.
Soldering Time	3 sec. Max. (one time only)	Pre-heat Time	60 sec. Max.
		Solder Wave	260°C Max.
		Soldering Time	5 sec. Max.

Note: Excessive soldering temperature and / or time might result in deformation of the LED lens or catastrophic failure of the LED.

6. Drive Method

An LED is a current-operated device. In order to ensure intensity uniformity on multiple LEDs connected in parallel in an application, it is recommended that a current limiting resistor be incorporated in the drive circuit, in series with each LED as shown in Circuit A below.

Circuit model A

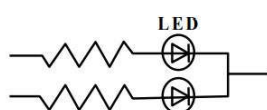

Circuit model B

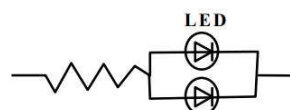

503SIRC2H-5AE

5mm, Infrared Emitting diode
Round With Flange Type

Technical Data Sheet

(A) Recommended circuit

(B) The brightness of each LED might appear different due to the differences in the I-V characteristics of those LEDs.

7. Repairing

Repair should not be done after the LEDs have been soldered. When repairing is unavoidable, a double-head soldering iron should be used. It should be confirmed beforehand whether the characteristics of the LEDs will or will not be damaged by repairing.

8. ESD (Electrostatic Discharge)

Static Electricity or power surge will damage the LED. Suggestions to prevent ESD damage:

8.1. Use a conductive wrist band or anti- electrostatic glove when handling these LEDs.

8.2. All devices, equipment, and machinery must be properly grounded.

8.3. Work tables, storage racks, etc. should be properly grounded.

8.4. Use ion blower to neutralize the static charge which might have built up on surface of the LEDs plastic lens as a result of friction between LEDs during storage and handing.

ESD-damaged LEDs will exhibit abnormal characteristics such as high reverse leakage current, low forward voltage, or “no light up” at low currents.

To verify for ESD damage, check for “light up” and VF of the suspect LEDs at low currents.

The VF of “good” LEDs should be $>2.0V@0.1mA$ for InGaN product and $>1.4V@0.1mA$ for AlInGaP product.

9. Others

9.1 The information included in this document reflects representative usage scenarios and is intended for technical reference only.

9.2 The part number, type, and specifications mentioned in this document are subject to future change and improvement without notice. Before production usage customer should refer to the latest datasheet for the updated specifications.

9.3 When using the products referenced in this document, please make sure the product is being operated within the environmental and electrical limits specified in the datasheet. If customer usage exceeds the specified limits, LuckyLight will not be responsible for any subsequent issues.

9.4 The LEDs described here are intended to be used for ordinary electronic equipment (such as office equipment, communication equipment and household applications). Consult LuckyLight's Sales in advance for information on applications in which exceptional reliability is required, particularly when the failure or malfunction of the LEDs may directly jeopardize life or health, such as in aviation, transportation, traffic control equipment, medical and life support systems and safety devices.