

304PDC2E-1A

3mm,Photodiode
Round With Flange Type

Technical Data Sheet

Features:

- Low power consumption.
- General purpose leads.
- Bulk, Available on tape and reel.
- Fast response time.
- Low dark Current.
- Small junction capacitance.
- Compliance with EU REACH.
- The product itself will remain within RoHS compliant Version.

Descriptions:

- The 304PD is a high speed and high sensitive PIN photodiode in a standard 3Φ plastic package.
- Due to its Clear epoxy the device is sensitive to near and infrared radiation.

Applications:

- High speed photo detector.
- Automatic door sensor.
- Security system.
- Industrial equipment.
- Infrared application system.

Device Selection Guide

Part No.	Emitting Color	Lens Color
304PDC2E-1A	Photodiode	Water Clear

304PDC2E-1A

3mm, Photodiode
Round With Flange Type

Technical Data Sheet

Package Dimension:

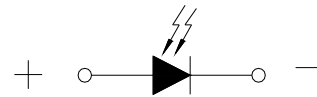
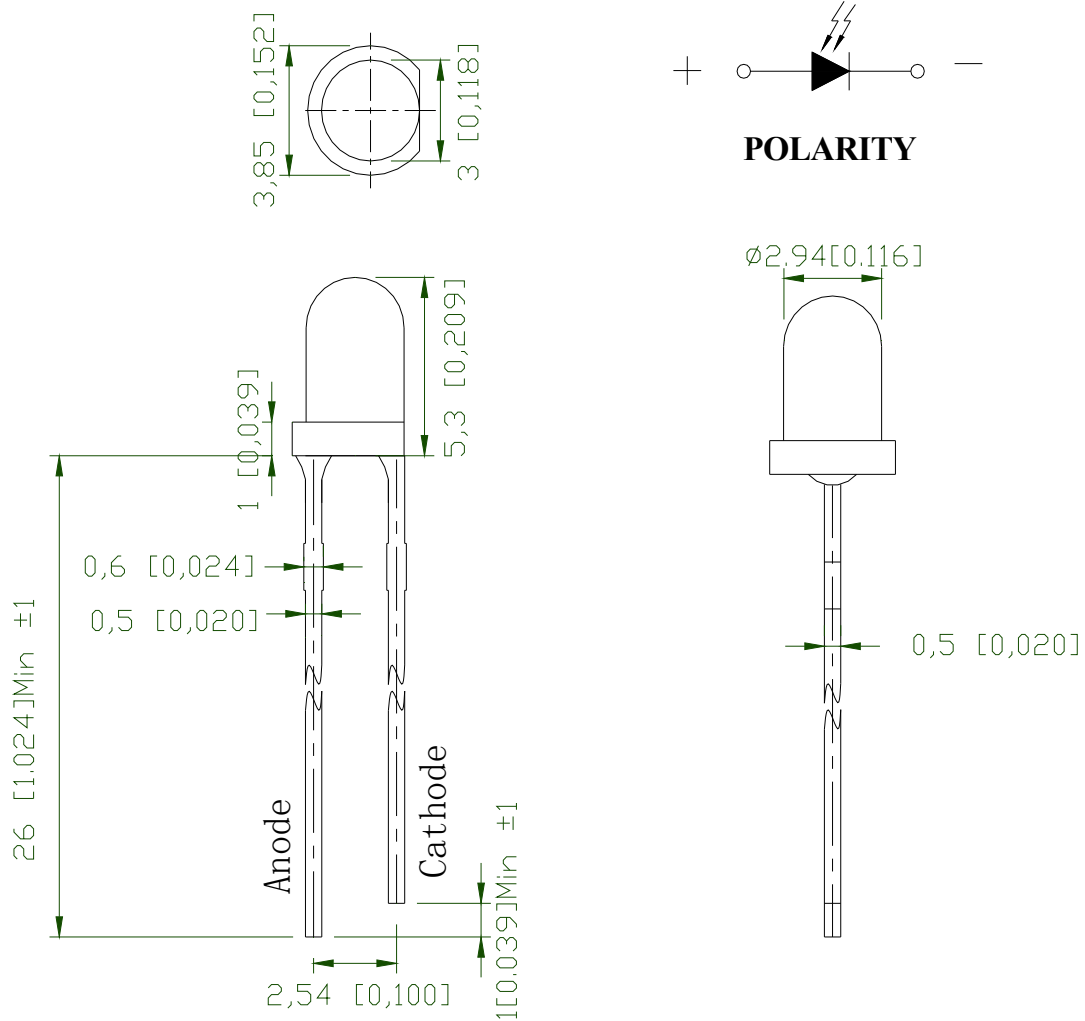

POLARITY

Notes:

1. All dimensions are in millimeters (inches).
2. Tolerance is ± 0.25 mm (.010") unless otherwise noted.
3. Protruded resin under flange is 1.00mm (.039") max.

304PDC2E-1A

3mm, Photodiode
Round With Flange Type



Technical Data Sheet

Absolute Maximum Ratings at Ta=25°C

Parameters	Symbol	Max.	Unit
Power Dissipation	P_d	150	mW
Reverse Voltage	V_R	32	V
Operating Temperature Range	T_{opr}	-40°C to +80°C	
Storage Temperature Range	T_{stg}	-40°C to +85°C	
Lead Soldering Temperature [4mm (.157") From Body]	T_{sld}	260°C for 5 Seconds	

Electrical Optical Characteristics at Ta=25°C

Parameters	Symbol	Min.	Typ.	Max.	Unit	Test Condition
Luminous Intensity	$\lambda_{0.5}$	400	---	1100	nm	
Open-Circuit Voltage	V_{oc}	---	0.40	---	V	Ee=5mW/cm ² $\lambda_p=850\text{nm}$
Short-Circuit Current	I_{sc}	---	35	---	μA	Ee=1mW/cm ² $\lambda=850\text{nm}$
Peak Emission Wavelength	λ_p	---	850	---	nm	IF=20mA
Reverse Light Current	I_L	20	35	---	μA	$V_R=5\text{V}$ Ee=1mW/cm ² $\lambda=850\text{nm}$
Dark Current	I_D	---	5	30	nA	$V_R=10\text{V}$ Ee=0mW/m ²
Reverse Breakdown Voltage	B_{VR}	32	170	---	V	IR=100 μA , Ee=0mW/cm ²
Total Capacitance	C_t	---	18	---	pF	Ee=0mW/cm ² $V_R=5\text{V}$ f=1MHZ
Rise Time (10% to 90%)	T_r	---	45	---	nS	$V_R=10\text{V}$, $R_L=100\Omega$
Fall Time (90% to 10%)	T_f	---	45	---		
Receiving Angle	$2\theta_{1/2}$	---	80	---	deg.	IF=20mA

Technical Data Sheet

Typical Electrical / Optical Characteristics Curves (25°C Ambient Temperature Unless Otherwise Noted)

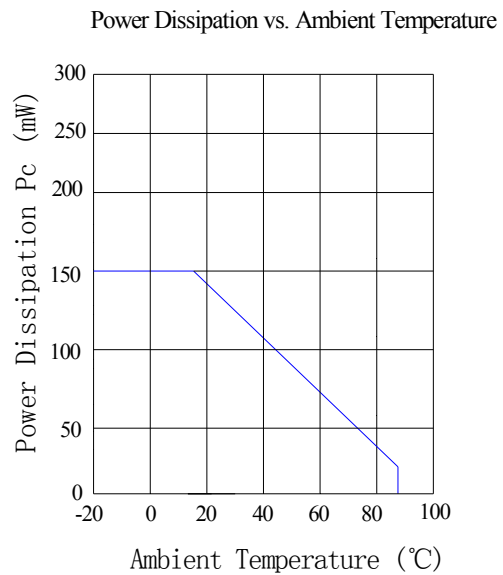
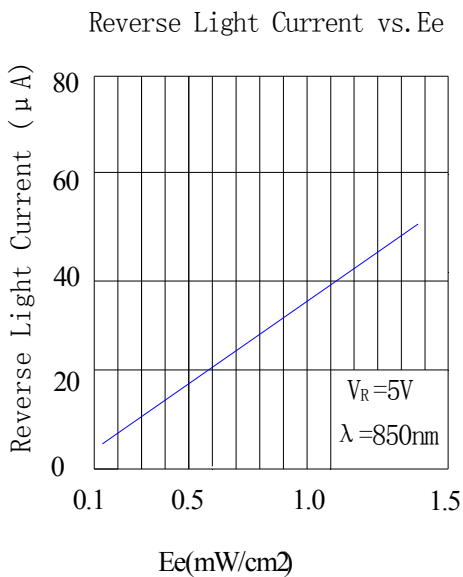
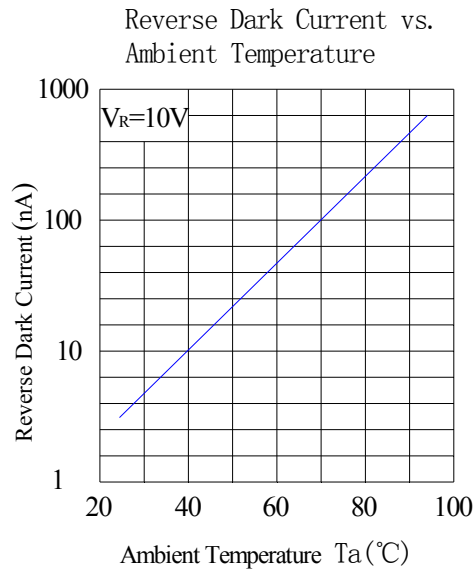
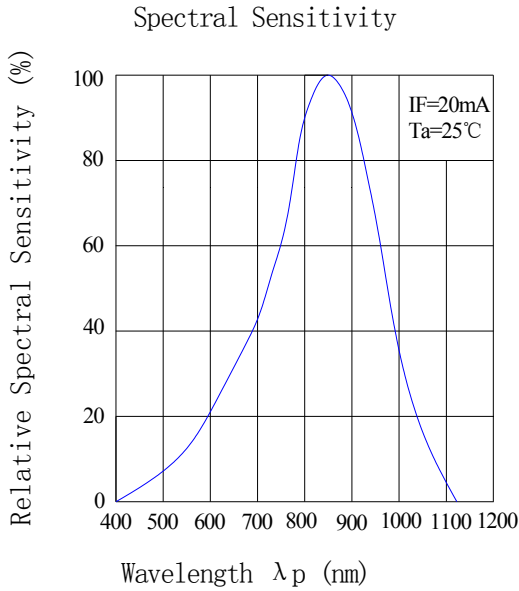

Technical Data Sheet

Response Time vs. Load Resistance

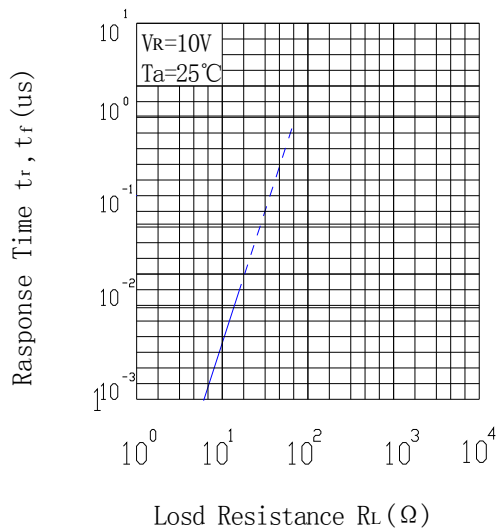

Relative Radiant Intensity vs. Angular Displacement

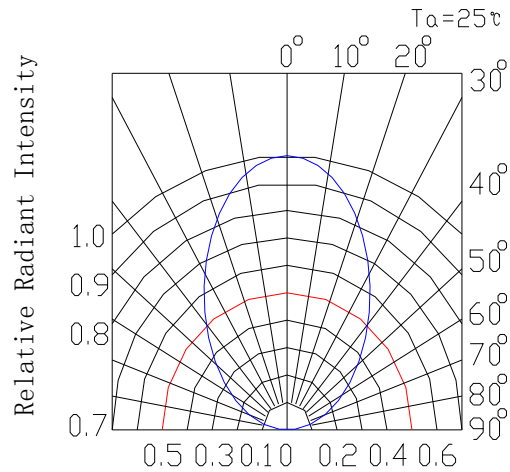

Terminal Capacitance vs. Reverse voltage

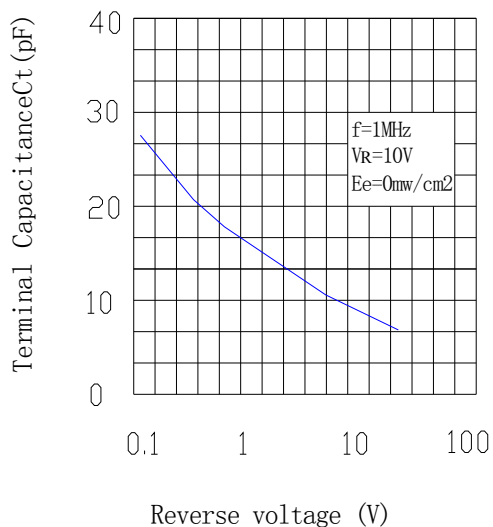

Relative Reverse Light Current vs. Ambient Temperature ($^\circ C$)

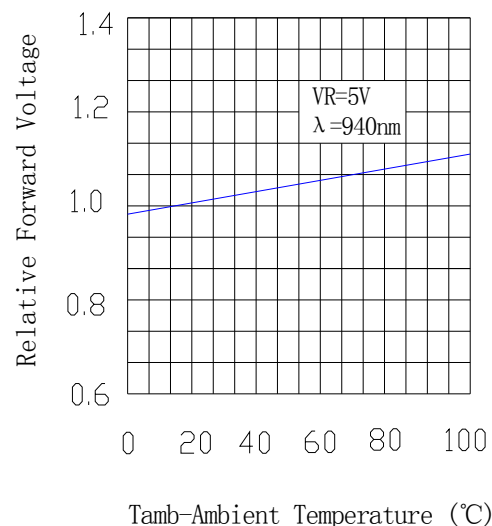

304PDC2E-1A

3mm,Photodiode
Round With Flange Type

Technical Data Sheet

Packing & Label Specifications:

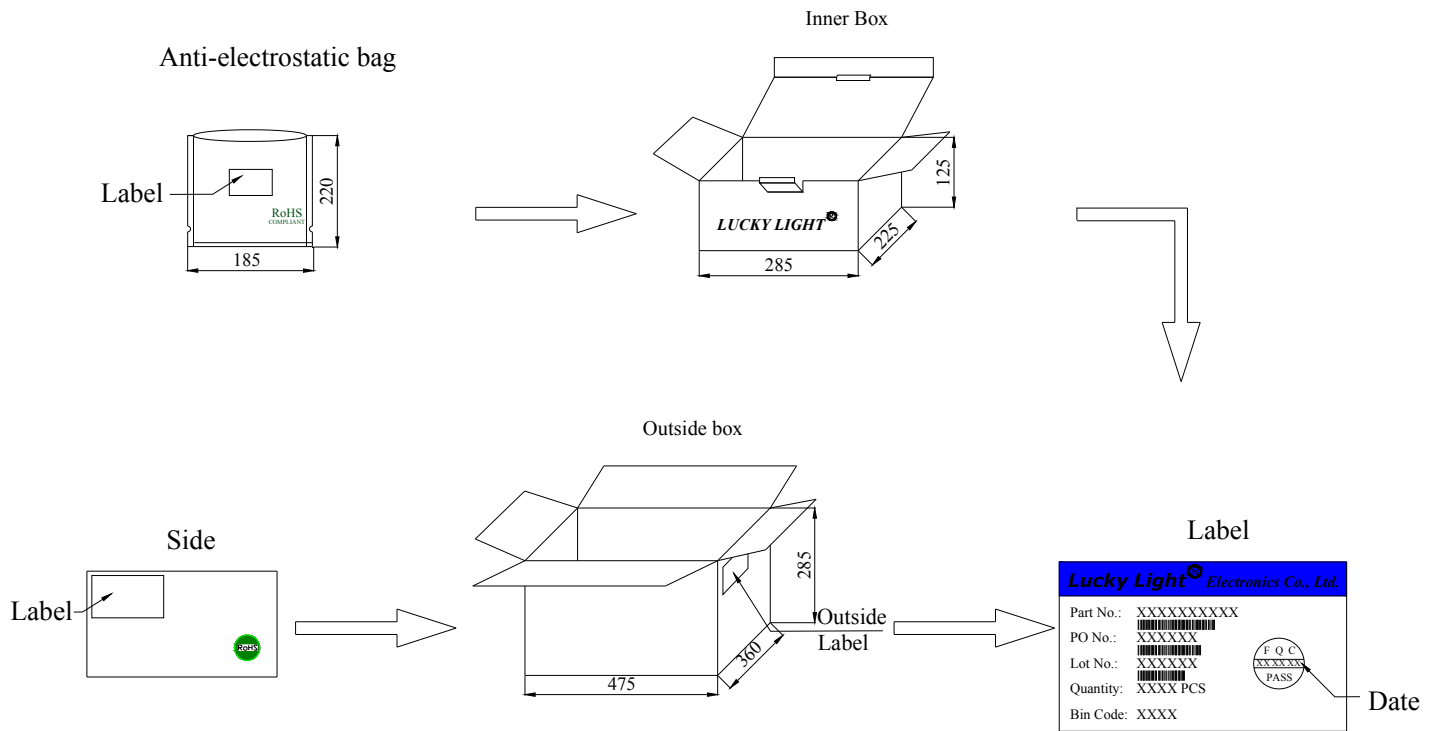

Packing Quantity:

- a. 1000 PCS/bag.
- b. 12000 PCS/Inner Box.
- c. 6 Inner Boxes/Outside Box.

Technical Data Sheet

CAUTIONS

1. Over-current-proof

Customer must apply resistors for protection, otherwise slight voltage shift will cause big current change (Burn out will happen).

2. Storage

2.1 The LEDs should be stored at 30°C or less and 70%RH or less after being shipped from LuckyLight and the storage life limits are 3 months. If the LEDs are stored for 3 months or more, they can be stored for a year in a sealed container with a nitrogen atmosphere and moisture absorbent material.

2.2 Please avoid rapid transitions in ambient temperature, especially, in high humidity environments where condensation can occur.

3. Cleaning

Use alcohol-based cleaning solvents such as isopropyl alcohol to clean the LEDs if necessary.

4. Lead Forming & Assembly

During lead forming, the leads should be bent at a point at least 1.6mm from the base of LED lens. Do not use the base of the lead frame as a fulcrum during forming. Lead forming must be done before soldering, at normal temperature. During assembly on PCB, use minimum clinch force possible to avoid excessive mechanical stress.

5. Soldering

When soldering, for Lamp without stopper type and must be leave a minimum of 3mm clearance from the base of the lens to the soldering point. Do not apply any external stress to the lead frame during soldering while the LED is at high temperature.

Recommended soldering conditions:

Soldering Iron		Wave Soldering	
Temperature	300°C Max.	Pre-heat	100°C Max.
Soldering Time	3 sec. Max. (one time only)	Pre-heat Time	60 sec. Max.
		Solder Wave	260°C Max.
		Soldering Time	5 sec. Max.

Note: Excessive soldering temperature and / or time might result in deformation of the LED lens or catastrophic failure of the LED.

6. Repairing

Repair should not be done after the LEDs have been soldered. When repairing is unavoidable, a double-head soldering iron should be used. It should be confirmed beforehand whether the characteristics of the LEDs will or will not be damaged by repairing.

7. ESD (Electrostatic Discharge)

Static Electricity or power surge will damage the LED. Suggestions to prevent ESD damage:

7.1. Use a conductive wrist band or anti- electrostatic glove when handling these LEDs.

7.2. All devices, equipment, and machinery must be properly grounded.

Technical Data Sheet

7.3. Work tables, storage racks, etc. should be properly grounded.

7.4. Use ion blower to neutralize the static charge which might have built up on surface of the LEDs plastic lens as a result of friction between LEDs during storage and handing.

ESD-damaged LEDs will exhibit abnormal characteristics such as high reverse leakage current, low forward voltage, or “no light up” at low currents.

To verify for ESD damage, check for “light up” and VF of the suspect LEDs at low currents.

The VF of “good” LEDs should be $>2.0V@0.1mA$ for InGaN product and $>1.4V@0.1mA$ for AlInGaP product.

8. Others

8.1. The information included in this document reflects representative usage scenarios and is intended for technical reference only.

8.2. The part number, type, and specifications mentioned in this document are subject to future change and improvement without notice. Before production usage customer should refer to the latest datasheet for the updated specifications.

8.3. When using the products referenced in this document, please make sure the product is being operated within the environmental and electrical limits specified in the datasheet. If customer usage exceeds the specified limits, LuckyLight will not be responsible for any subsequent issues.

8.4. The LEDs described here are intended to be used for ordinary electronic equipment (such as office equipment, communication equipment and household applications). Consult LuckyLight's Sales in advance for information on applications in which exceptional reliability is required, particularly when the failure or malfunction of the LEDs may directly jeopardize life or health, such as in aviation, transportation, traffic control equipment, medical and life support systems and safety devices.