

**ZXLD1356/ ZXLD1356Q**

**60V 550mA LED DRIVER and AUTOMOTIVE GRADE**

**Description**

The ZXLD1356 is a continuous mode inductive step-down converter, designed for driving single or multiple series connected LEDs efficiently from a voltage source higher than the LED voltage. The device operates from an input supply between 6V and 60V and provides an externally adjustable output current of up to 550mA. Depending upon supply voltage and external components, this can provide up to 30 watts of output power.

The ZXLD1356 has been qualified to AECQ100 Grade 1 enabling operation in ambient temperatures from -40°C to +125°C

Output current can be adjusted above, or below the set value, by applying an external control signal to the 'ADJ' pin. Enhanced output current dimming can be achieved by applying a PWM signal to the 'ADJ' pin.

**Features**

- Typically better than 0.8% output current accuracy
- Simple and with low part count
- Single pin on/off and brightness control using DC voltage or PWM
- PWM resolution up to 1000:1
- High efficiency (up to 97%)
- Wide input voltage range: 6V to 60V
- Inherent open-circuit LED protection
- **Available in thermally enhanced packages**
  - **V-DFN3030-6**     $\theta_{JA}$     **44°C/W**
  - **TSOT25**         $\theta_{JA}$         **82°C/W**
- Available in "Green" Molding Compound (No Br, Sb) with lead Free Finish/ RoHS Compliant
  - **Totally Lead-Free & Fully RoHS Compliant (Notes 1 & 2)**
  - **Halogen and Antimony Free. "Green" Device (Note 3)**
- ZXLD1356QET5TA Automotive Grade qualified to AEC-Q100 Grade 1

Notes: 1. No purposely added lead. Fully EU Directive 2002/95/EC (RoHS) & 2011/65/EU (RoHS 2) compliant.  
 2. See <http://www.diodes.com> for more information about Diodes Incorporated's definitions of Halogen and Antimony free, "Green" and Lead-Free.  
 3. Halogen and Antimony free "Green" products are defined as those which contain <900ppm bromine, <900ppm chlorine (<1500ppm total Br + Cl) and <1000ppm antimony compounds.

**Pin Assignments**

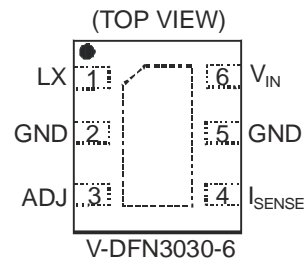
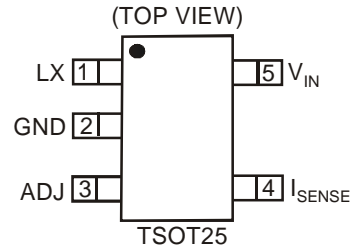

**Applications**

- Low Voltage Halogen Replacement LEDs
- Automotive Lighting
- Low Voltage Industrial Lighting
- LED Back-Up Lighting
- Illuminated Signs
- Emergency Lighting
- SELV Lighting
- Refrigeration Lights

**Typical Applications Circuit**

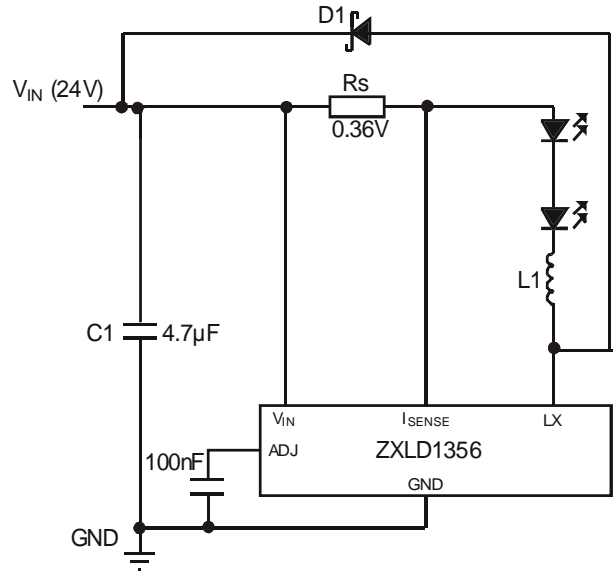

**Pin Descriptions**

| Pin Name | Pin Number |             | Function  |
|----------|------------|-------------|---|
|          | TSOT25     | V-DFN3030-6 |   |
| LX       | 1          | 1           | Drain of NDMOS switch   |
| GND      | 2          | 2, 5        | Ground (0V)   |
| ADJ      | 3          | 3           | Multi-function On/Off and brightness control pin: <ul style="list-style-type: none"> <li>Leave floating for normal operation. (<math>V_{ADJ} = V_{REF} = 1.25V</math> giving nominal average output current <ul style="list-style-type: none"> <li><math>I_{OUTnom} = 0.2V/R_S</math>)</li> </ul> </li> <li>Drive to voltage below 0.2V to turn off output current</li> <li>Drive with DC voltage (<math>0.3V &lt; V_{ADJ} &lt; 2.5V</math>) to adjust output current from 24% to 200% of <math>I_{OUTnom}</math></li> <li>Connect a capacitor from this pin to ground to define soft-start time. Soft-start time is approx. <math>0.2ms/nF</math></li> </ul> |
| ISENSE   | 4          | 4           | Connect resistor $R_S$ from this to $V_{IN}$ to define nominal average output current $I_{OUTnom} = 0.2/R_S$ (Note: $R_{SMIN} = 0.36V$ with ADJ pin open circuit)   |
| VIN      | 5          | 6           | Input voltage (6V to 60V). Decouple to ground with 4.7µF of higher X7R ceramic capacitor close to device  |
| Pad      | —          | Pad         | Exposed pad (EP) - connected to device substrate. To improve thermal impedance of package the EP must be connected to power ground but should not be used as the 0V (GND) current path. It can be left floating but must not be connected to any other voltage other than 0V.   |

**Functional Block Diagram**

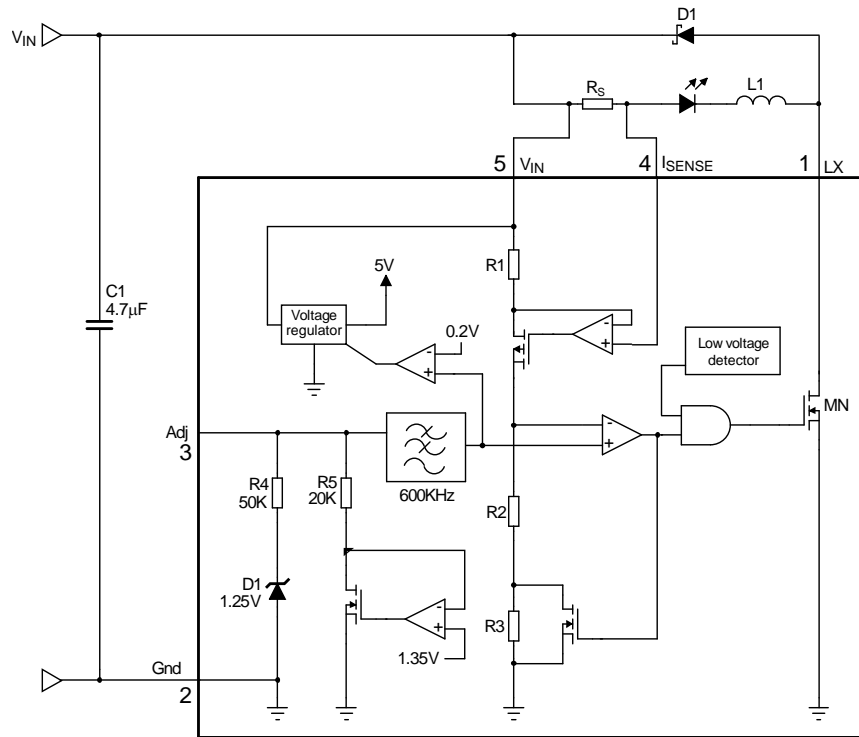

Figure 1. Block Diagram – Pin Connections Shown for TSOT25 Package

**Absolute Maximum Ratings** (Voltages to GND, unless otherwise specified.)

| Symbol             | Parameter  | Rating  | Unit |
|--------------------|--|---|------|
| V <sub>IN</sub>    | Input Voltage  | -0.3 to +60<br>(65V for 0.5 sec)                            | V    |
| V <sub>SENSE</sub> | I <sub>SENSE</sub> Voltage   | +0.3 to -5.0<br>(measured with respect to V <sub>IN</sub> ) | V    |
| V <sub>LX</sub>    | LX Output Voltage  | -0.3 to +60<br>(65V for 0.5 sec)                            | V    |
| V <sub>ADJ</sub>   | Adjust Pin Input Voltage   | -0.3 to +6.0  | V    |
| I <sub>LX</sub>    | Switch Output Current  | 0.65  | A    |
| P <sub>TOT</sub>   | Power Dissipation<br>(Refer to package thermal de-rating curve on page 25) | TSOT25  | 1    |
|                    |  | V-DFN3030-6   | 1.8  |
| T <sub>ST</sub>    | Storage Temperature  | -55 to +150   | °C   |
| T <sub>J MAX</sub> | Junction Temperature   | 150   | °C   |

These are stress ratings only. Operation outside the absolute maximum ratings may cause device failure. Operation at the absolute maximum rating for extended periods may reduce device reliability.

| ESD Susceptibility   |        |      |
|----------------------|--------|------|
|                      | Rating | Unit |
| Human Body Model     | 500    | V    |
| Charged Device Model | >1000  | V    |
| Machine Model        | <100   | V    |

Semiconductor devices are ESD sensitive and may be damaged by exposure to ESD events. Suitable ESD precautions should be taken when handling and transporting these devices. The human body model is a 100pF capacitor discharge through a 1.5kΩ resistor pin. The machine model is a 200pF capacitor discharged directly into each pin.

## Thermal Resistance

| Symbol        | Parameter           | Rating |             | Unit |
|---------------|---------------------|--------|-------------|------|
|               |                     | TSOT25 | V-DFN3030-6 |      |
| $\theta_{JA}$ | Junction to Ambient | 82     | 44          | °C/W |
| $\Psi_{JB}$   | Junction to Board   | 33     | —           | °C/W |
| $\theta_{JC}$ | Junction to Case    | —      | 14          | °C/W |

## Recommended Operating Conditions (@ $T_A = +25^\circ\text{C}$ , unless otherwise specified.)

| Symbol        | Parameter  | Min  | Max  | Units |
|---------------|--|------|------|-------|
| $V_{IN}$      | Input voltage (Note 4)                           | 6    | 60   | V     |
| $t_{OFFMIN}$  | Minimum switch off-time                          |      | 800  | ns    |
| $t_{ONMIN}$   | Minimum switch on-time                           |      | 800  | ns    |
| $f_{LX\ max}$ | Recommended maximum operating frequency (Note 5) |      | 625  | kHz   |
| $D_{LX}$      | Duty cycle range                                 | 0.01 | 0.99 |       |
| $T_{OP}$      | Operating temperature range                      | -40  | +125 | °C    |

Notes: 4.  $V_{IN} > 16\text{V}$  to fully enhance output transistor. Otherwise out current must be derated - see graphs. Operation at low supply may cause excessive heating due to increased on-resistance. Tested at 7V guaranteed for 6V by design.  
5. ZXLD1356 will operate at higher frequencies but accuracy will be affected due to propagation delays.

**ZXLD1356/ ZXLD1356Q**

**Electrical Characteristics** ( $V_{IN} = 24V$ , @ $T_{AMB} = +25^{\circ}C$ , unless otherwise specified.)

| Symbol                    | Parameter   | Condition  | Min        | Typ        | Max        | Unit             |
|---------------------------|---|--|------------|------------|------------|------------------|
| $V_{SU}$                  | Internal regulator start-up threshold   |  |            | 4.85       | 5.2        | V                |
| $V_{SD}$                  | Internal regulator shutdown threshold   |  | 4.40       | 4.75       |            | V                |
| $I_{INQoff}$              | Quiescent supply current with output off  | ADJ pin grounded   |            | 65         | 108        | $\mu A$          |
| $I_{INQon}$               | Quiescent supply current with output switching (Note 6)                                 | ADJ pin floating, L = 68mH, 3 LEDsf = 360kHz   |            | 1.6        |            | mA               |
| $V_{SENSE}$               | Mean current sense threshold voltage (Defines LED current setting accuracy)             | Measured on $I_{SENSE}$ pin with respect to $V_{IN}$ $V_{ADJ} = 1.25V$ ; $V_{IN} = 18V$  | 195        | 200        | 205        | mV               |
| $V_{SENSEHYS}$            | Sense threshold hysteresis  |  |            | $\pm 15$   |            | %                |
| $I_{SENSE}$               | $I_{SENSE}$ pin input current   | $V_{SENSE} = V_{IN} - 0.2$   |            | 4          | 10         | $\mu A$          |
| $V_{REF}$                 | Internal reference voltage  | Measured on ADJ pin with pin floating  |            | 1.25       |            | V                |
| $\Delta V_{REF}/\Delta T$ | Temperature coefficient of $V_{REF}$  |  |            | 50         |            | ppm/ $^{\circ}C$ |
| $V_{ADJ}$                 | External control voltage range on ADJ pin for DC brightness control (Note 7)            |  | 0.3        |            | 2.5        | V                |
| $V_{ADJoff}$              | DC voltage on ADJ pin to switch device from active (on) state to quiescent (off) state  | $V_{ADJ}$ falling  | 0.15       | 0.20       | 0.27       | V                |
| $V_{ADJon}$               | DC voltage on ADJ pin to switch device from quiescent (off) state to active (on) state  | $V_{ADJ}$ rising   | 0.2        | 0.25       | 0.3        | V                |
| $R_{ADJ}$                 | Resistance between ADJ pin and $V_{REF}$  | $0 < V_{ADJ} < V_{REF}$ , $V_{ADJ} > V_{REF} + 100mV$  | 30<br>10.4 | 50<br>14.2 | 65<br>18.0 | k $\Omega$       |
| $I_{LXmean}$              | Continuous LX switch current  |  |            |            | 0.55       | A                |
| $R_{LX}$                  | LX switch 'On' resistance   | @ $I_{LX} = 0.55A$   |            | 0.5        | 0.75       | $\Omega$         |
| $I_{LX(leak)}$            | LX switch leakage current   |  |            |            | 5          | $\mu A$          |
| $D_{PWM(LF)}$             | Duty cycle range of PWM signal applied to ADJ pin during low frequency PWM dimming mode | PWM frequency <300Hz PWM amplitude = $V_{REF}$<br>Measured on ADJ pin  | 0.001      |            | 1          |                  |
|                           | Brightness control range  |  |            |            | 1000:1     |                  |
| $DC_{ADJ}^{(*)}$          | DC Brightness control range   | Note 8   |            | 5:1        |            |                  |
| $t_{SS}$                  | Start up time (See graphs for more details)   | Time taken for output current to reach 90% of final value after voltage on ADJ pin has risen above 0.3V. Requires external capacitor 22nF. |            | 2          |            | ms               |
| $f_{LX}$                  | Operating frequency (See graphs for more details)                                       | ADJ pin floating L= 68mH (0.36V)<br>$I_{OUT} = 0.55A$ @ $V_{LED} = 3.6V$<br>Driving 3 LEDs   |            | 360        |            | kHz              |
| $f_{LXmax}$               | Recommended maximum operating frequency   |  |            |            | 500        | kHz              |

- Notes:
6. Static current of device is approximately 700  $\mu A$ , see Graph, Page 17.
  7. 100% brightness corresponds to  $V_{ADJ} = V_{ADJ(nom)} = V_{REF}$ . Driving the ADJ pin above  $V_{REF}$  will increase the  $V_{SENSE}$  threshold and output current proportionally.
  8. Ratio of maximum brightness to minimum brightness before shutdown  $V_{REF} = 1.25/0.25$ .  $V_{REF}$  externally driven to 2.5V, ratio 10.1.

## Device Description

The device, in conjunction with the coil (L1) and current sense resistor (R<sub>S</sub>), forms a self-oscillating continuous-mode buck converter.

**Device operation** (refer to Figure 1 - Block diagram and Figure 2 operating waveforms)

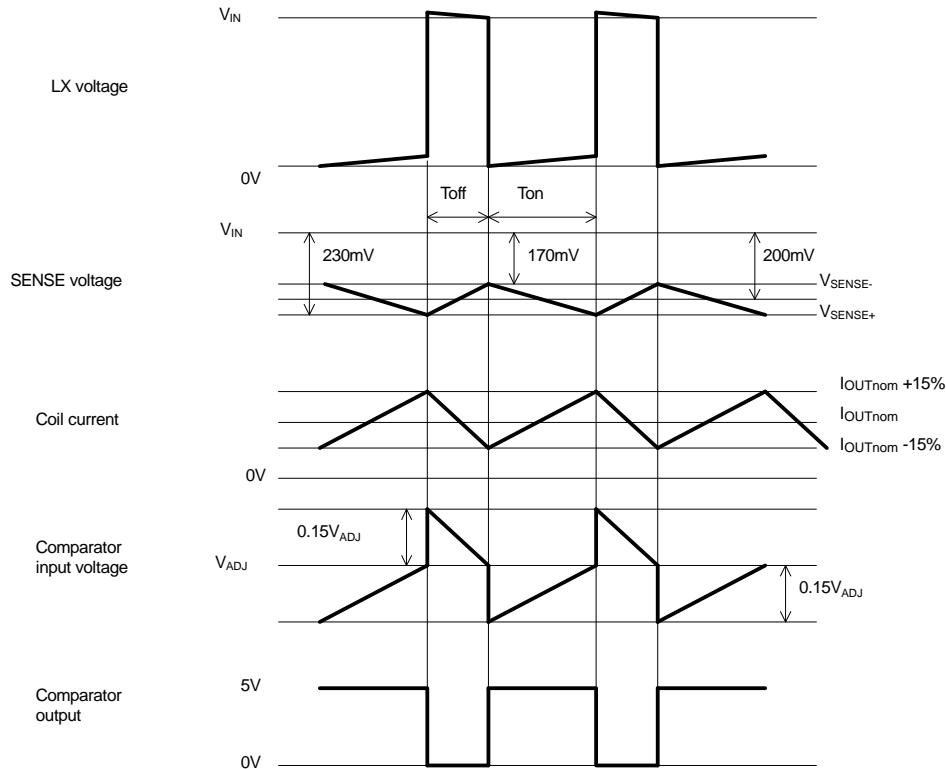

**Figure 2. Theoretical Operating Waveforms**

Operation can be best understood by assuming that the ADJ pin of the device is unconnected and the voltage on this pin ( $V_{ADJ}$ ) appears directly at the (+) input of the comparator.

When input voltage  $V_{IN}$  is first applied, the initial current in L1 and  $R_S$  is zero and there is no output from the current sense circuit. Under this condition, the (-) input to the comparator is at ground and its output is high. This turns MN on and switches the LX pin low, causing current to flow from  $V_{IN}$  to ground, via  $R_S$ , L1 and the LED(s). The current rises at a rate determined by  $V_{IN}$  and L1 to produce a voltage ramp ( $V_{SENSE}$ ) across  $R_S$ . The supply referred voltage  $V_{SENSE}$  is forced across internal resistor R1 by the current sense circuit and produces a proportional current in internal resistors R2 and R3. This produces a ground referred rising voltage at the (-) input of the comparator. When this reaches the threshold voltage ( $V_{ADJ}$ ), the comparator output switches low and MN turns off. The comparator output also drives another NMOS switch, which bypasses internal resistor R3 to provide a controlled amount of hysteresis. The hysteresis is set by R3 to be nominally 15% of  $V_{ADJ}$ .

When MN is off, the current in L1 continues to flow via D1 and the LED(s) back to  $V_{IN}$ . The current decays at a rate determined by the LED(s) and diode forward voltages to produce a falling voltage at the input of the comparator. When this voltage returns to  $V_{ADJ}$ , the comparator output switches high again. This cycle of events repeats, with the comparator input ramping between limits of  $V_{ADJ} \pm 15\%$ .

### Switching Thresholds

With  $V_{ADJ} = V_{REF}$ , the ratios of R1, R2 and R3 define an average  $V_{SENSE}$  switching threshold of 200mV (measured on the I<sub>SENSE</sub> pin with respect to  $V_{IN}$ ). The average output current  $I_{OUTnom}$  is then defined by this voltage and  $R_S$  according to:

$$I_{OUTnom} = 200mV/R_S$$

Nominal ripple current is  $\pm 30mV/R_S$

---

**Device Description** (cont.)

---

**Adjusting Output Current**

The device contains a low pass filter between the ADJ pin and the threshold comparator and an internal current limiting resistor (50k $\Omega$  nom) between ADJ and the internal reference voltage. This allows the ADJ pin to be overdriven with either DC or pulse signals to change the  $V_{SENSE}$  switching threshold and adjust the output current.

Details of the different modes of adjusting output current are given in the applications section.

**Output Shutdown**

The output of the low pass filter drives the shutdown circuit. When the input voltage to this circuit falls below the threshold (0.2V nom.), the internal regulator and the output switch are turned off. The voltage reference remains powered during shutdown to provide the bias current for the shutdown circuit. Quiescent supply current during shutdown is nominally 60 $\mu$ A and switch leakage is below 5 $\mu$ A.

**ZXLD1356/ ZXLD1356Q**

**Actual Operating Waveforms [ $V_{IN} = 15V$ ,  $R_S = 0.36V$ ,  $L = 68\mu H$ ]**  
Normal operation. Output current (Ch3) and LX voltage (Ch2)

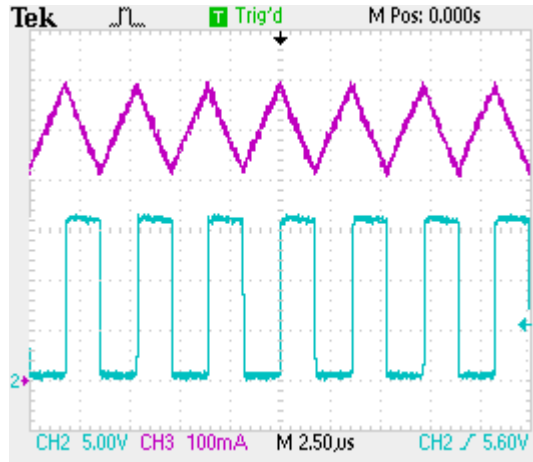

**Actual Operating Waveforms [ $V_{IN} = 30V$ ,  $R_S = 0.36V$ ,  $L = 68\mu H$ ]**  
Normal operation. Output current (Ch3) and LX voltage (Ch2)

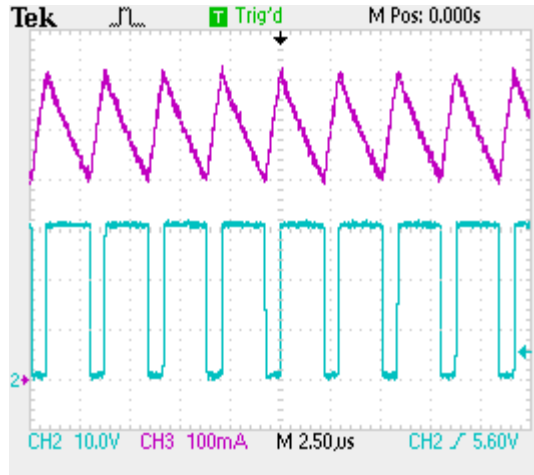

**Actual Operating Waveforms [ $V_{IN} = 60V$ ,  $R_S = 0.36V$ ,  $L = 68\mu H$ ]**  
Normal operation. Output current (Ch3) and LX voltage (Ch2)

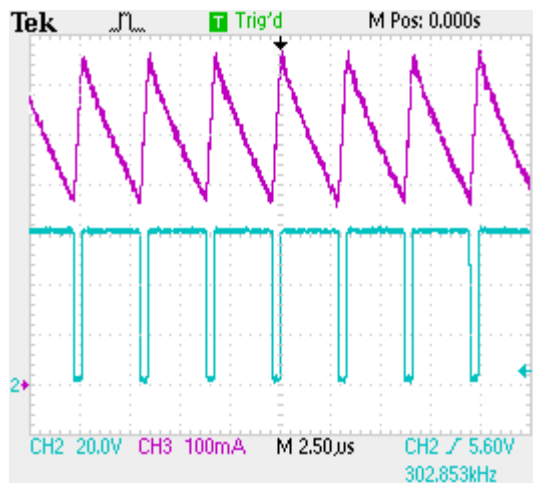



**Typical Operating Conditions**

ZXLD1356 Output Current  
L = 68μH

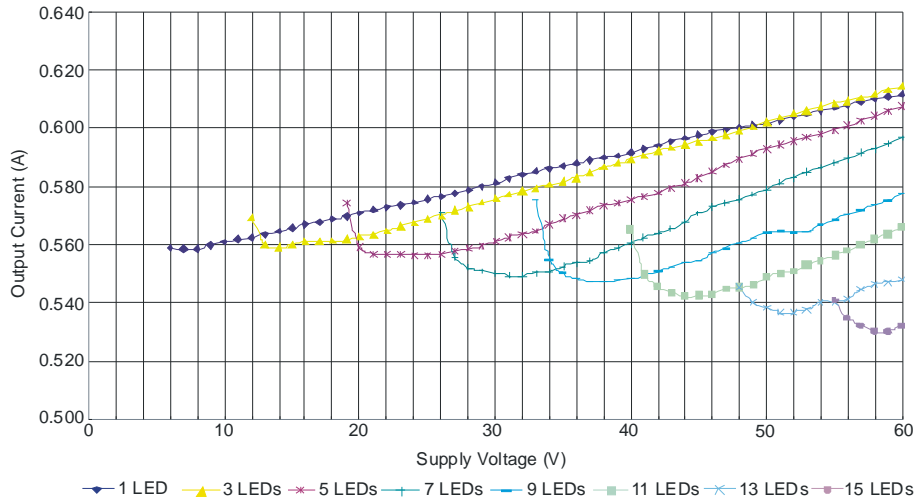

ZXLD1356 Output Current Deviation (Normalized)  
L = 68μH

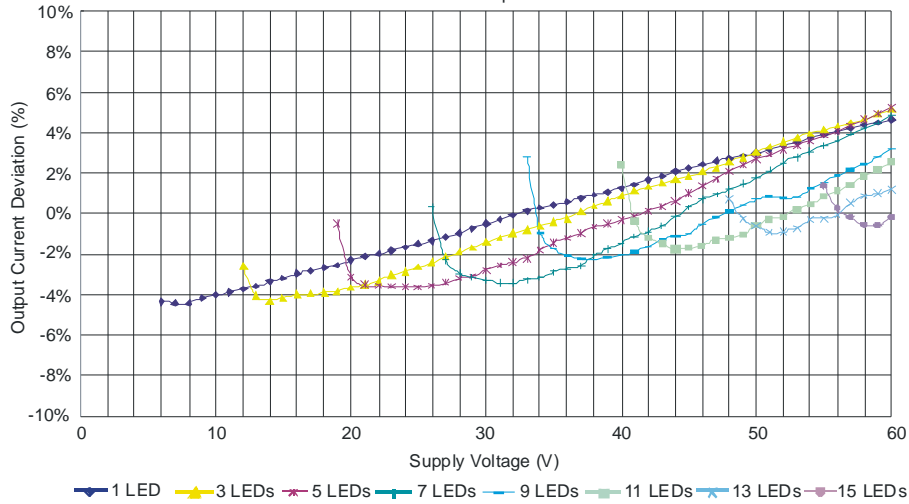

ZXLD1356 Efficiency  
L = 68μH

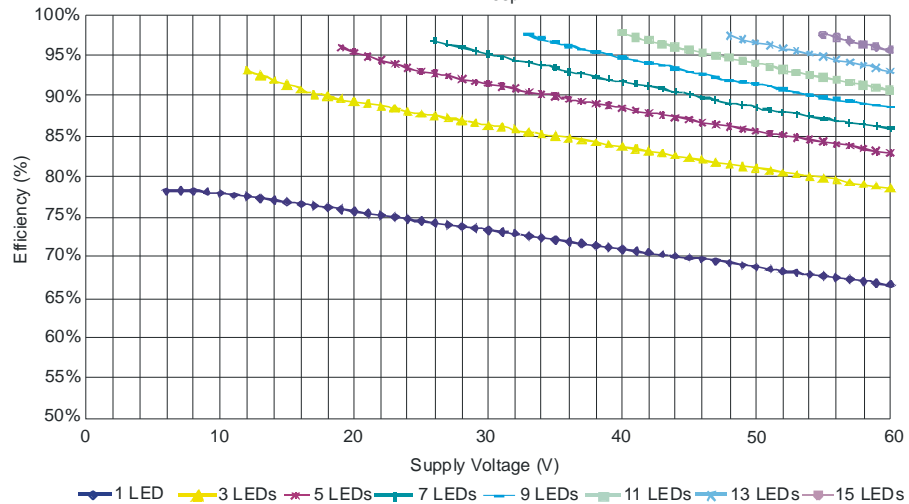

**Typical Operating Conditions** (cont.)

**ZXLD1356 Switching Frequency**  
L = 68μH

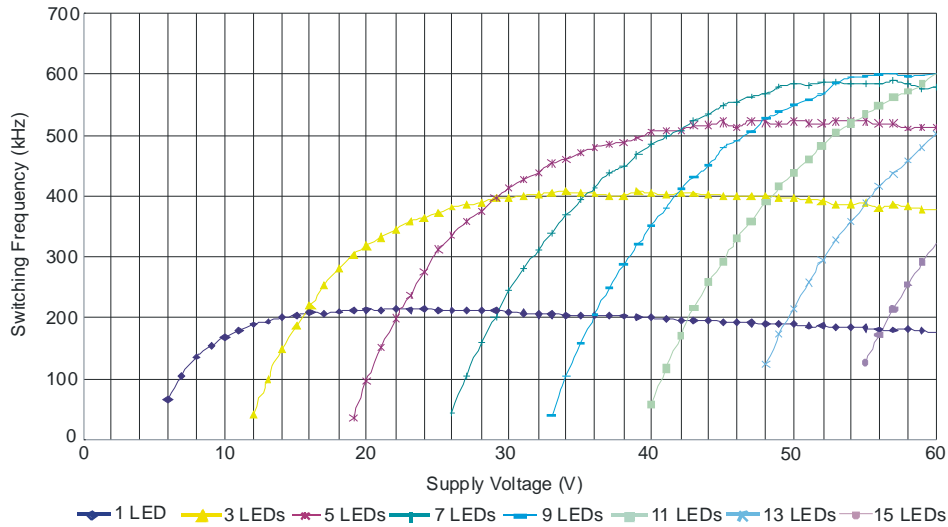

**ZXLD1356 Duty Cycle**  
L = 68μH

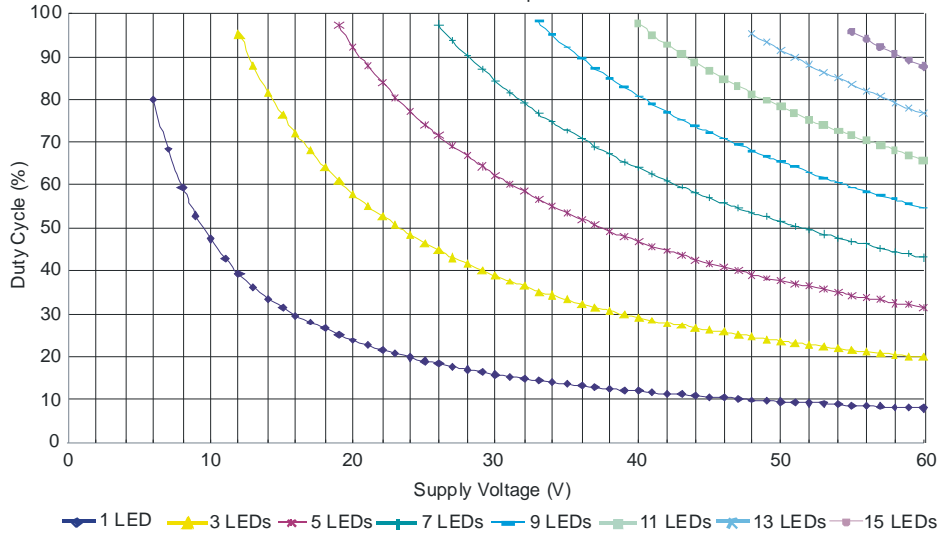

**ZXLD1356/ ZXLD1356Q**

**Typical Operating Conditions (cont.)**

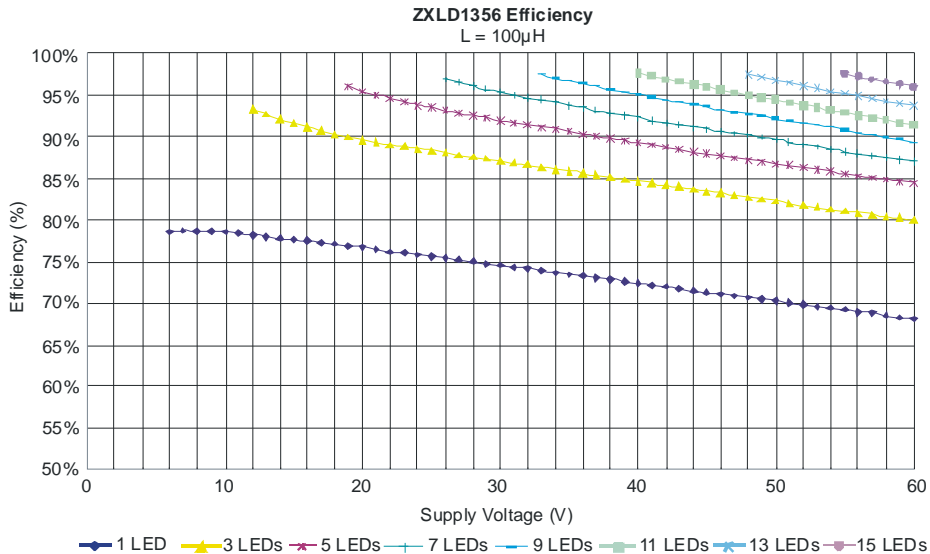
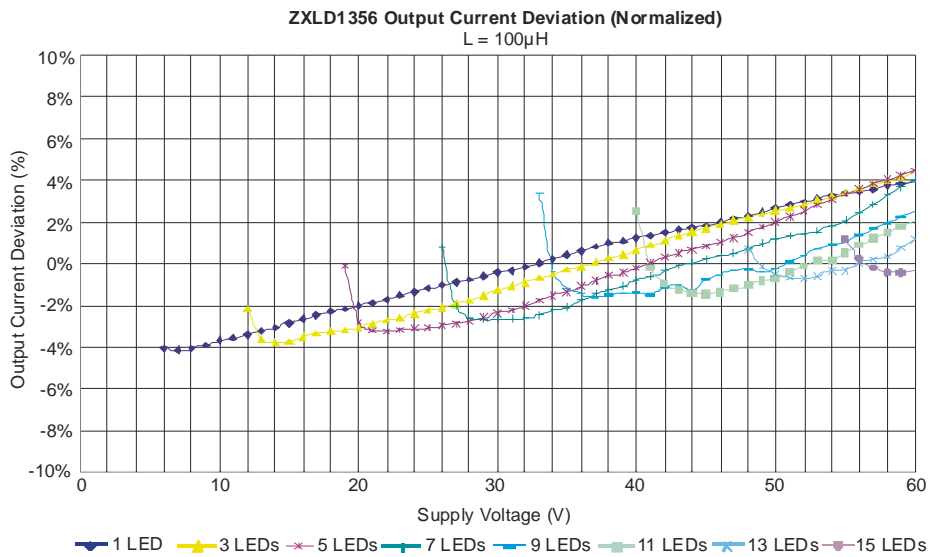
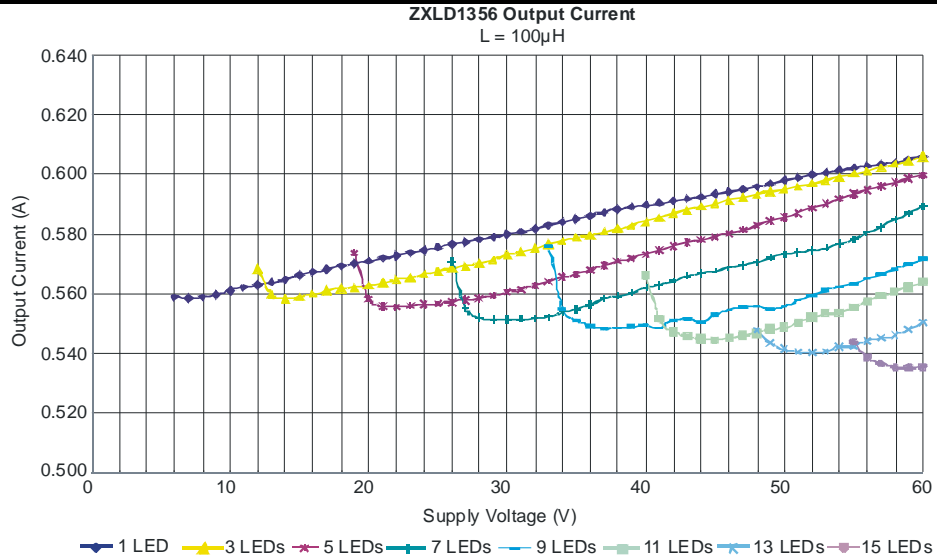

**Typical Operating Conditions** (cont.)

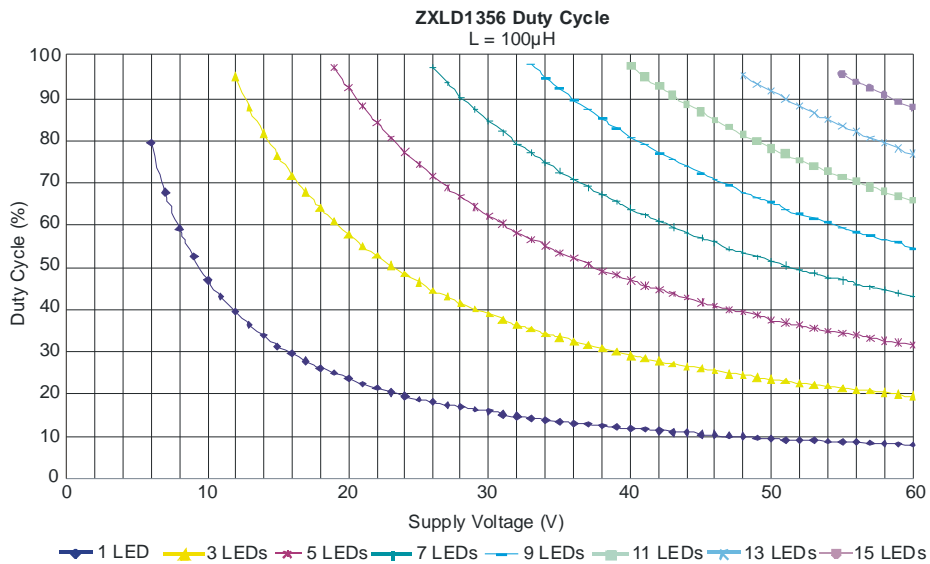
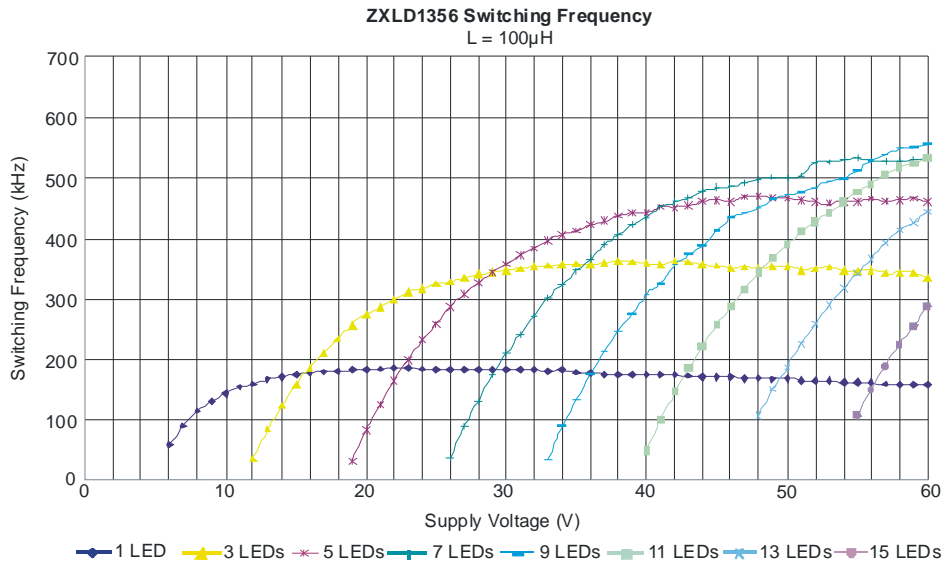

**Typical Operating Conditions** (cont.)

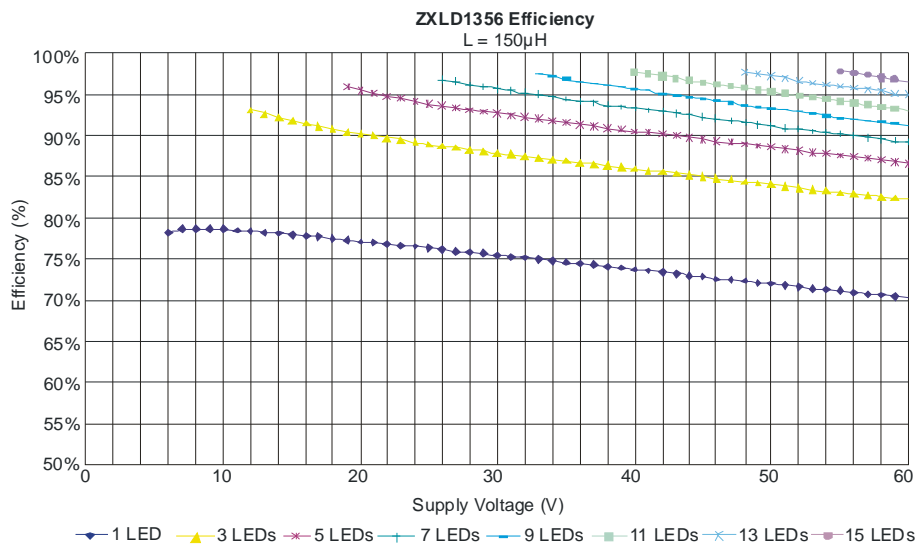
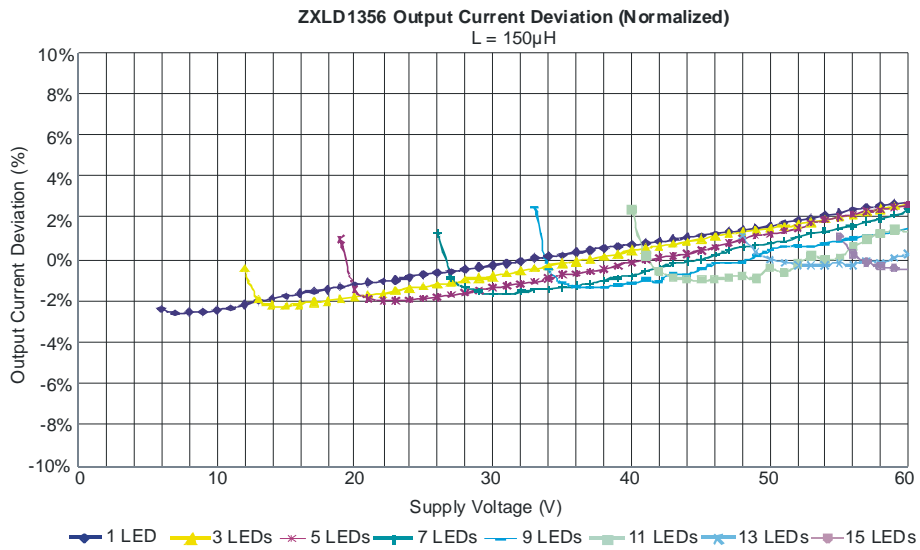
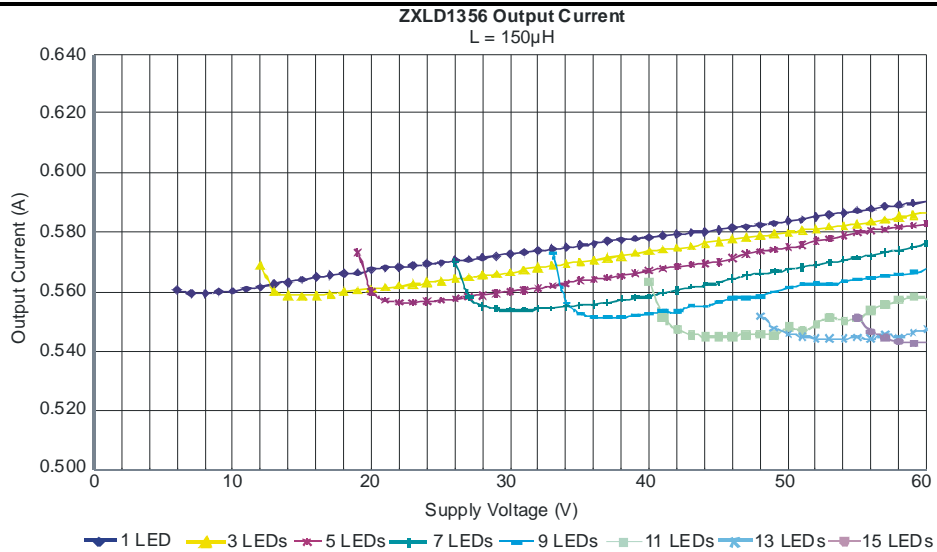

**Typical Operating Conditions** (cont.)

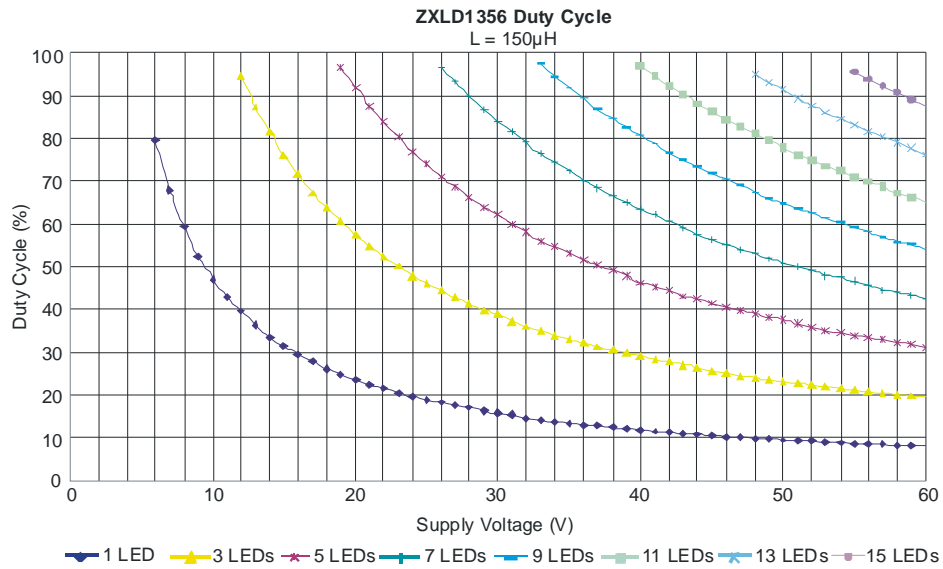
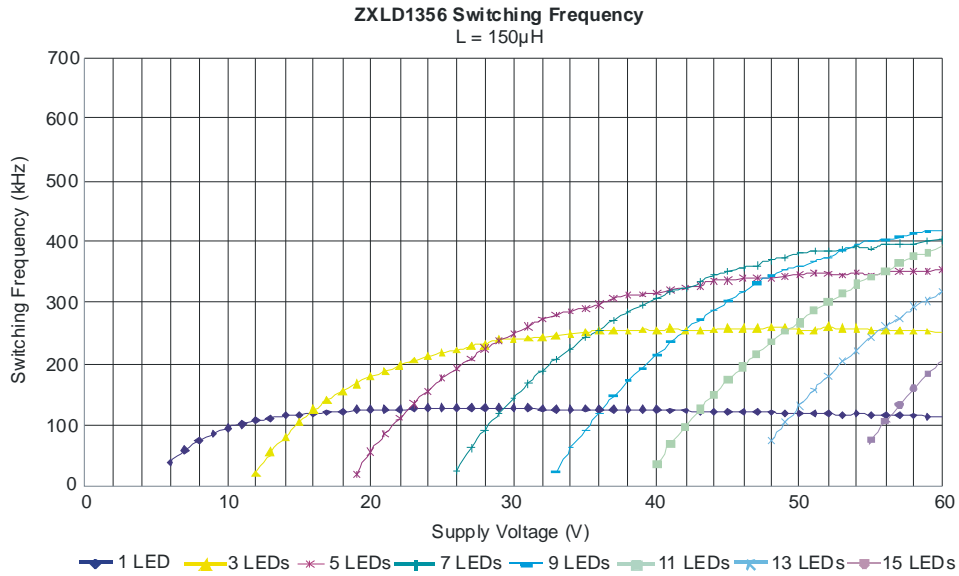

**ZXLD1356/ ZXLD1356Q**

**Typical Operating Conditions (cont.)**

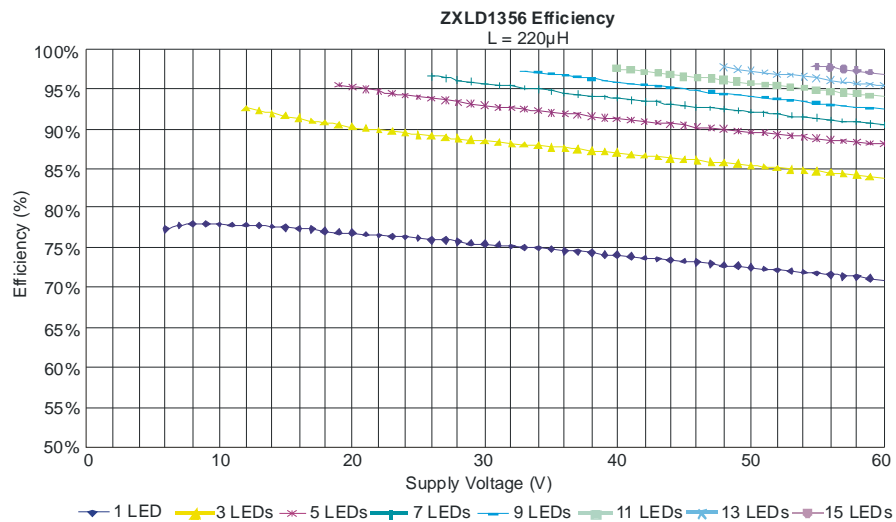
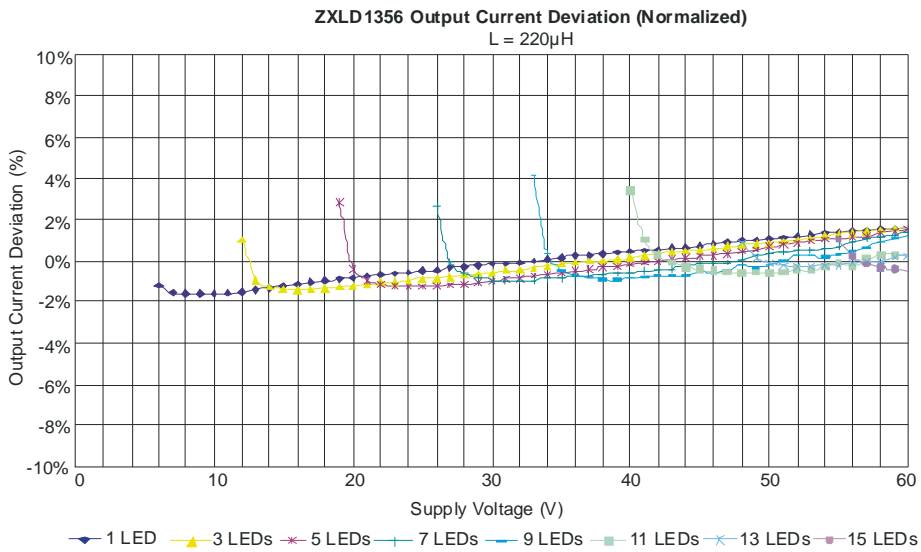
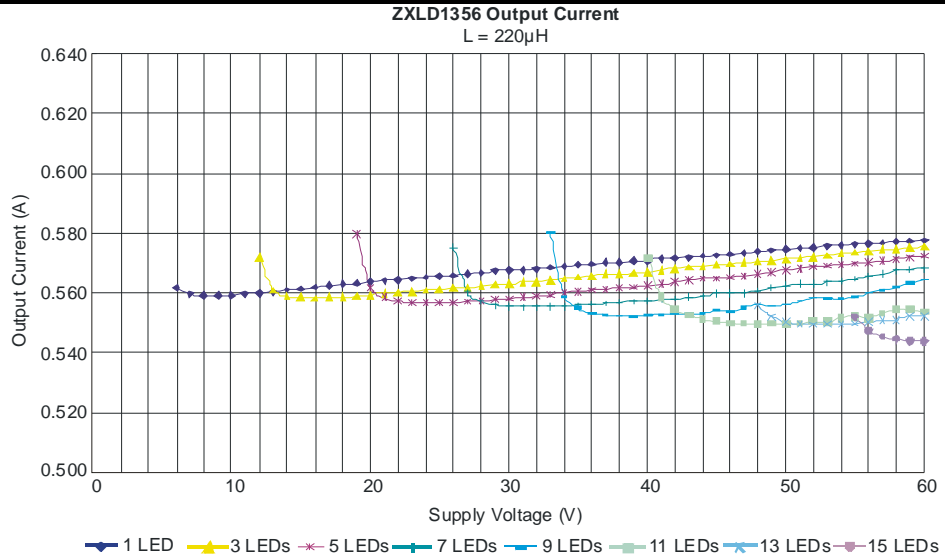

**Typical Operating Conditions** (cont.)

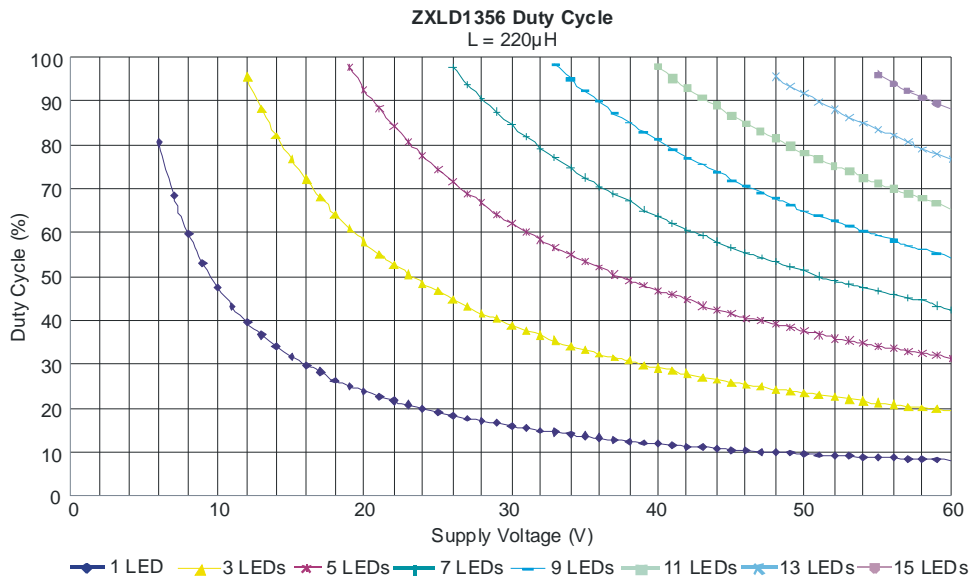
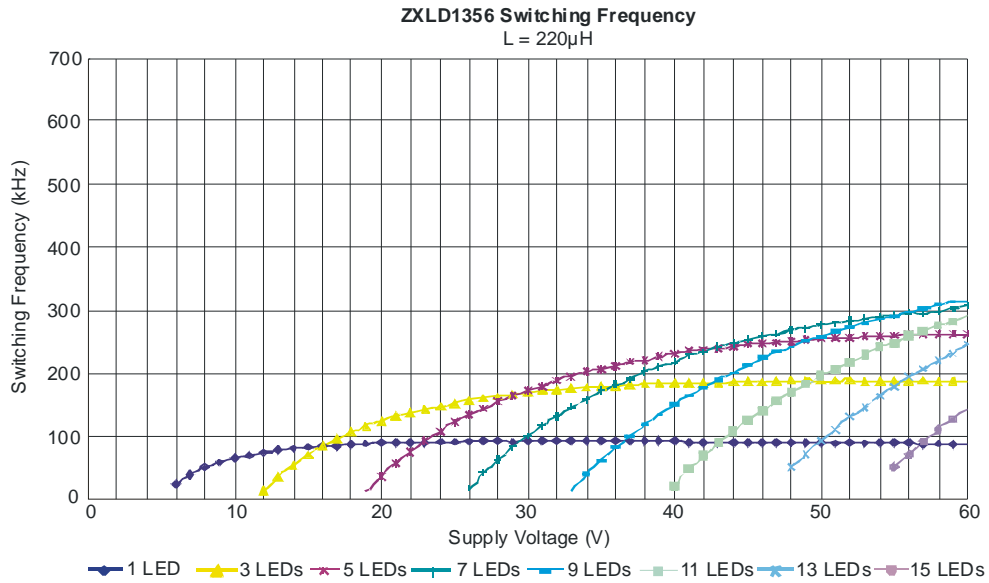



**Typical Operating Conditions** (cont.)

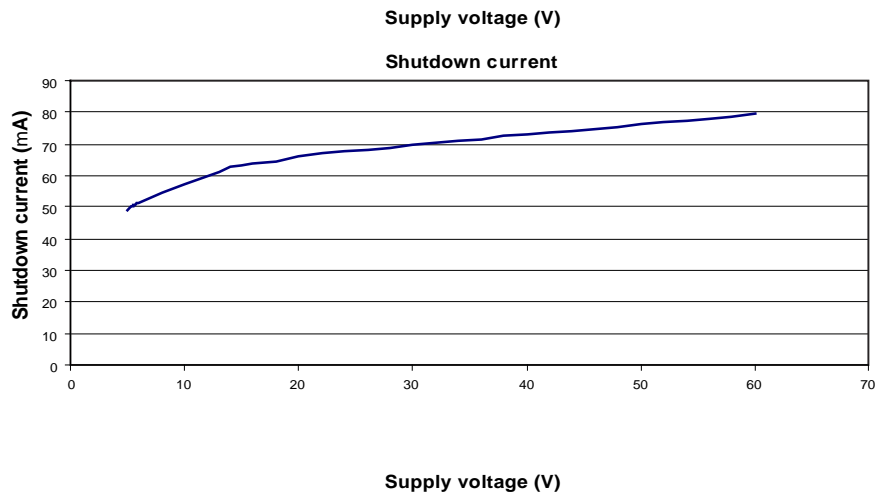
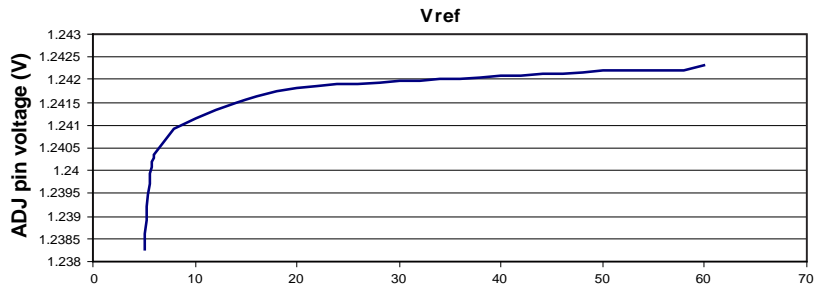
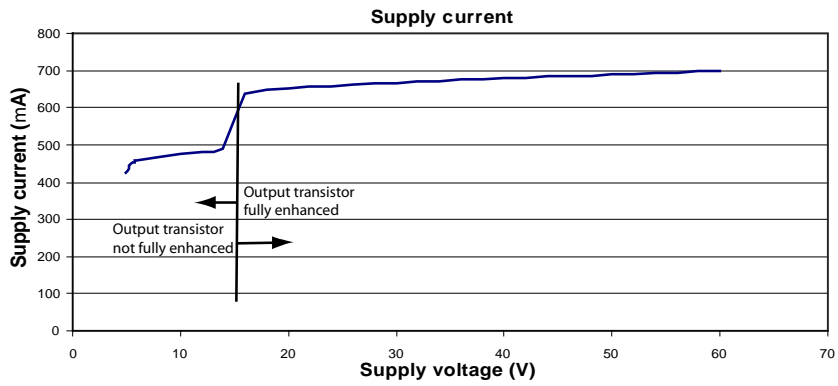
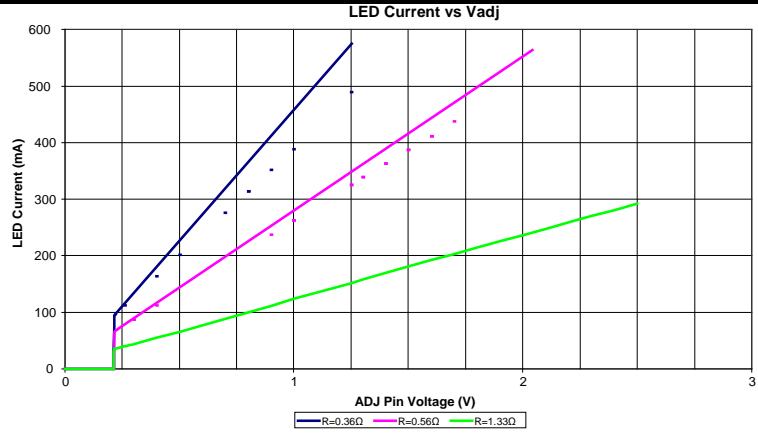

**Typical Operating Conditions** (cont.)

**Lx on-resistance vs supply voltage**

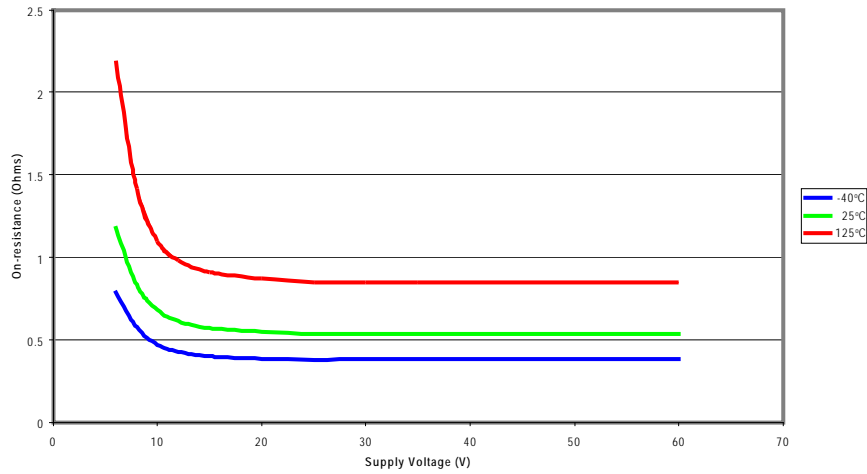

**Vadj vs Temperature**

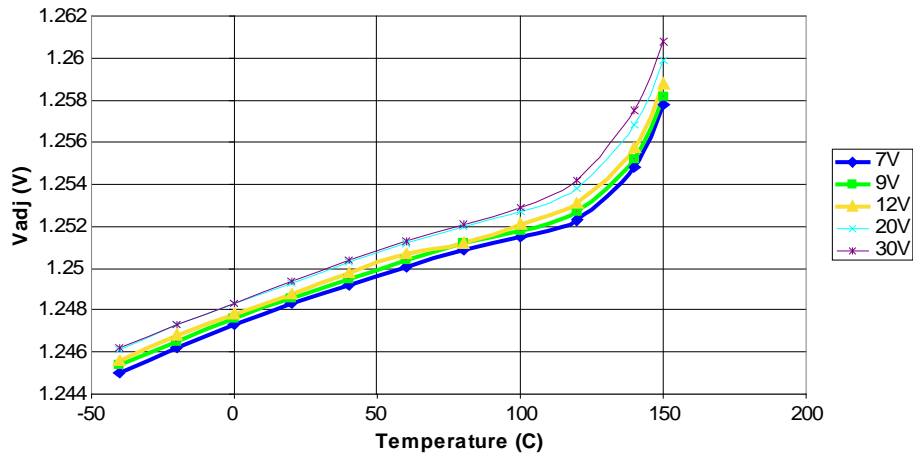

**Lx on-resistance vs die temperature**

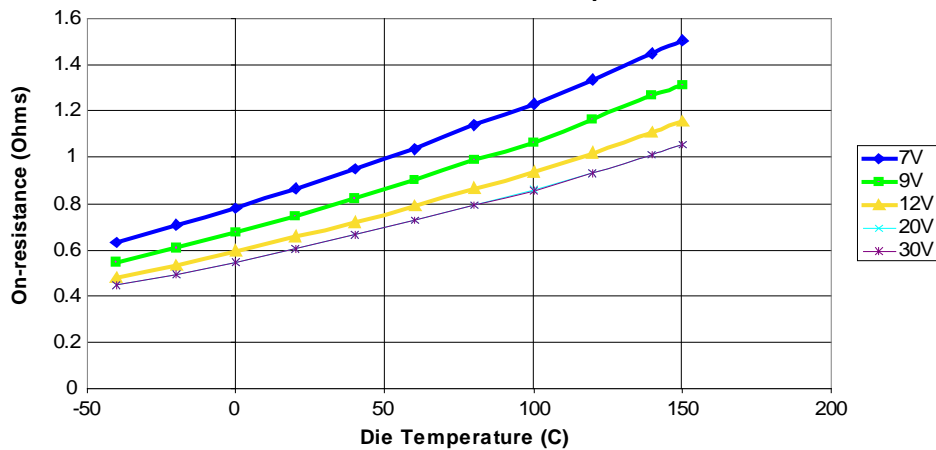

## Application Information

### Setting Nominal Average Output Current with External Resistor $R_S$

The nominal average output current in the LED(s) is determined by the value of the external current sense resistor ( $R_S$ ) connected between  $V_{IN}$  and  $I_{SENSE}$  and is given by:

$$I_{OUTnom} = 0.2/R_S \text{ [for } R_S > 0.36\Omega\text{]}$$

The table below gives values of nominal average output current for several preferred values of current setting resistor ( $R_S$ ) in the typical application circuit shown on page 1:

| $R_S(\Omega)$ | Nominal Average Output Current (mA) |
|---------------|-------------------------------------|
| 0.36          | 555                                 |
| 0.56          | 357                                 |
| 1.33          | 150                                 |

The above values assume that the ADJ pin is floating and at a nominal voltage of  $V_{REF}$  (= 1.25V). Note that  $R_S = 0.36\Omega$  is the minimum allowed value of sense resistor under these conditions to maintain switch current below the specified maximum value.

It is possible to use different values of  $R_S$  if the ADJ pin is driven from an external voltage. (See next section).

### Output Current Adjustment by External DC Control Voltage

The ADJ pin can be driven by an external dc voltage ( $V_{ADJ}$ ), as shown, to adjust the output current to a value above or below the nominal average value defined by  $R_S$ .

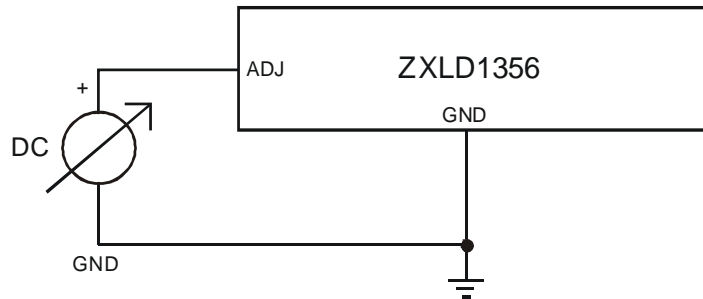

The nominal average output current in this case is given by:

$$I_{OUTdc} = (V_{ADJ} / 1.25) \times (0.2/R_S) \text{ [for } 0.3 < V_{ADJ} < 2.5\text{V]}$$

Note that 100% brightness setting corresponds to  $V_{ADJ} = V_{REF}$ . When driving the ADJ pin above 1.25V,  $R_S$  must be increased in proportion to prevent  $I_{OUTdc}$  exceeding 550mA maximum.

The input impedance of the ADJ pin is  $50k\Omega \pm 25\%$  for voltages below  $V_{REF}$  and  $14.2k\Omega \pm 25\%$  for voltages above  $V_{REF} + 100mV$ .

### Output Current Adjustment by PWM Control

#### Directly driving ADJ input

A Pulse Width Modulated (PWM) signal with duty cycle  $D_{PWM}$  can be applied to the ADJ pin, as shown below, to adjust the output current to a value above or below the nominal average value set by resistor  $R_S$ :

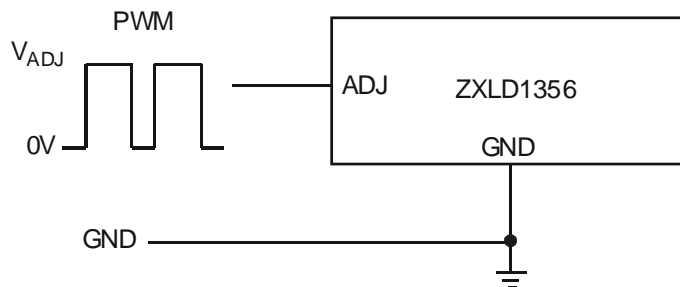

## Application Information (cont.)

### Driving the ADJ Input via Open Collector Transistor

The recommended method of driving the ADJ pin and controlling the amplitude of the PWM waveform is to use a small NPN switching transistor as shown below:

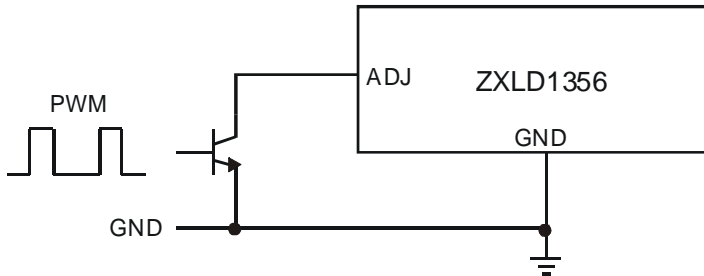

This scheme uses the 50k resistor between the ADJ pin and the internal voltage reference as a pull-up resistor for the external transistor eg MMBT3904.

### Driving the ADJ Input from a Microcontroller

Another possibility is to drive the device from the open drain output of a microcontroller. The diagram below shows one method of doing this:

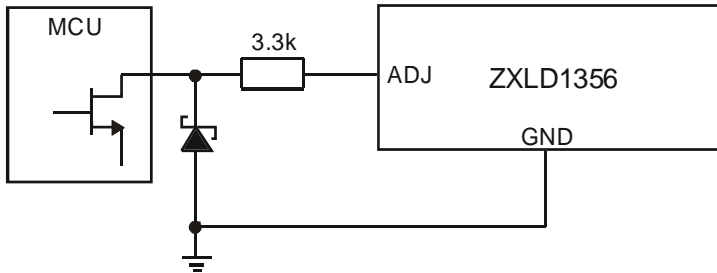

If the NMOS transistor within the microcontroller has high Gate / Drain capacitance, this arrangement can inject a negative spike into ADJ input of the ZXLD1356 and cause erratic operation but the addition of a Schottky clamp diode (eg Diodes Inc. SD103CWS) to ground and inclusion of a series resistor (3.3k) will prevent this. See the section on PWM dimming for more details of the various modes of control using high frequency and low frequency PWM signals.

### Shutdown Mode

Taking the ADJ pin to a voltage below 0.2V for more than approximately 100µs will turn off the output and supply current to a low standby level of 65µA nominal.

Note that the ADJ pin is not a logic input. Taking the ADJ pin to a voltage above  $V_{REF}$  will increase output current above the 100% nominal average value. (See page 17 graphs for details).

### Soft-Start

An external capacitor from the ADJ pin to ground will provide a soft-start delay, by increasing the time taken for the voltage on this pin to rise to the turn-on threshold and by slowing down the rate of rise of the control voltage at the input of the comparator. Adding capacitance increases this delay by approximately 0.2ms/nF. The graph on the next page shows the variation of soft-start time for different values of capacitor.

**Application Information** (cont.)

**Soft-Start** (cont.)

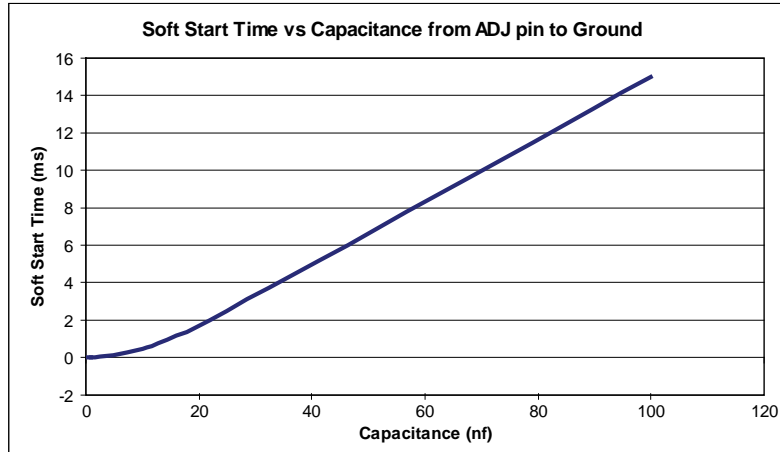

**Actual Operating Waveforms** [ $V_{IN} = 60V$ ,  $R_S = 0.36V$ ,  $L = 68\mu H$ ,  $22nF$  on ADJ]

Soft-start operation. LX voltage (Ch2) and Output current (Ch3) using a 22nF external capacitor on the ADJ pin.

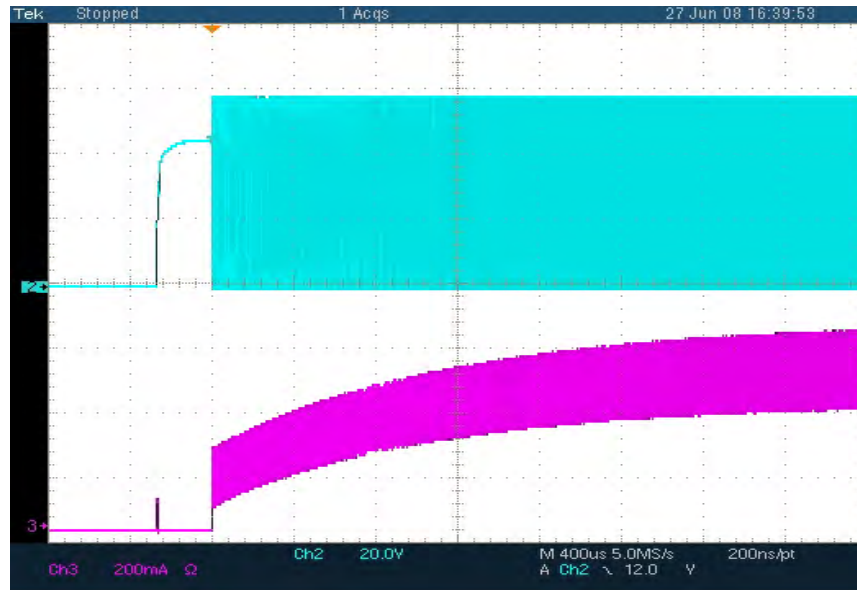

## Application Information (cont.)

### V<sub>IN</sub> Capacitor Selection

A low ESR capacitor should be used for input decoupling, as the ESR of this capacitor appears in series with the supply source impedance and lowers overall efficiency. This capacitor has to supply the relatively high peak current to the coil and smooth the current ripple on the input supply.

To avoid transients into the IC, the size of the input capacitor will depend on the V<sub>IN</sub> voltage:

|                             |                         |
|-----------------------------|-------------------------|
| V <sub>IN</sub> = 6 to 40V  | C <sub>IN</sub> = 2.2μF |
| V <sub>IN</sub> = 40 to 50V | C <sub>IN</sub> = 4.7μF |
| V <sub>IN</sub> = 50 to 60V | C <sub>IN</sub> = 10μF  |

When the input voltage is close to the output voltage the input current increases which puts more demand on the input capacitor. The minimum value of 2.2μF may need to be increased to 4.7μF; higher values will improve performance at lower input voltages, especially when the source impedance is high. The input capacitor should be placed as close as possible to the IC.

For maximum stability over temperature and voltage, capacitors with X7R, X5R, or better dielectric is recommended. Capacitors with Y5V dielectric are not suitable for decoupling in this application and should **NOT** be used.

When higher voltages are with C<sub>IN</sub> = 10μF, an electrolytic capacitor can be used provided that a suitable 1mF ceramic capacitor is also used and positioned as close to the V<sub>IN</sub> pin as possible.

A suitable capacitor would be NACEW100M1006.3x8TR13F (NIC Components).

The following web sites are useful when finding alternatives:

- [www.murata.com](http://www.murata.com)
- [www.niccomp.com](http://www.niccomp.com)
- [www.kemet.com](http://www.kemet.com)

### Inductor Selection

Recommended inductor values for the ZXLD1356 are in the range 68 μH to 220 μH.

Higher values of inductance are recommended at higher supply voltages in order to minimize errors due to switching delays, which result in increased ripple and lower efficiency. Higher values of inductance also result in a smaller change in output current over the supply voltage range. (see graphs pages 10-16). The inductor should be mounted as close to the device as possible with low resistance connections to the LX and V<sub>IN</sub> pins.

The chosen coil should have a saturation current higher than the peak output current and a continuous current rating above the required mean output current.

Suitable coils for use with the ZXLD1356 may be selected from the MSS range manufactured by Coilcraft, or the NPIS range manufactured by NIC components. The following websites may be useful in finding suitable components.

- [www.coilcraft.com](http://www.coilcraft.com)
- [www.niccomp.com](http://www.niccomp.com)
- [www.wuerth-elektronik.de](http://www.wuerth-elektronik.de)

The inductor value should be chosen to maintain operating duty cycle and switch 'on'/off' times within the specified limits over the supply voltage and load current range.

Figures 3 and 4 (following) can be used to select a recommended inductor based on maintaining the ZXLD1356 case temperature below 60°C for the different package types. For detailed performance characteristics for the inductor values 68, 100, 150 and 220μH see graphs on pages 10-16.

**Application Information** (cont.)

**Inductor Selection** (cont.)

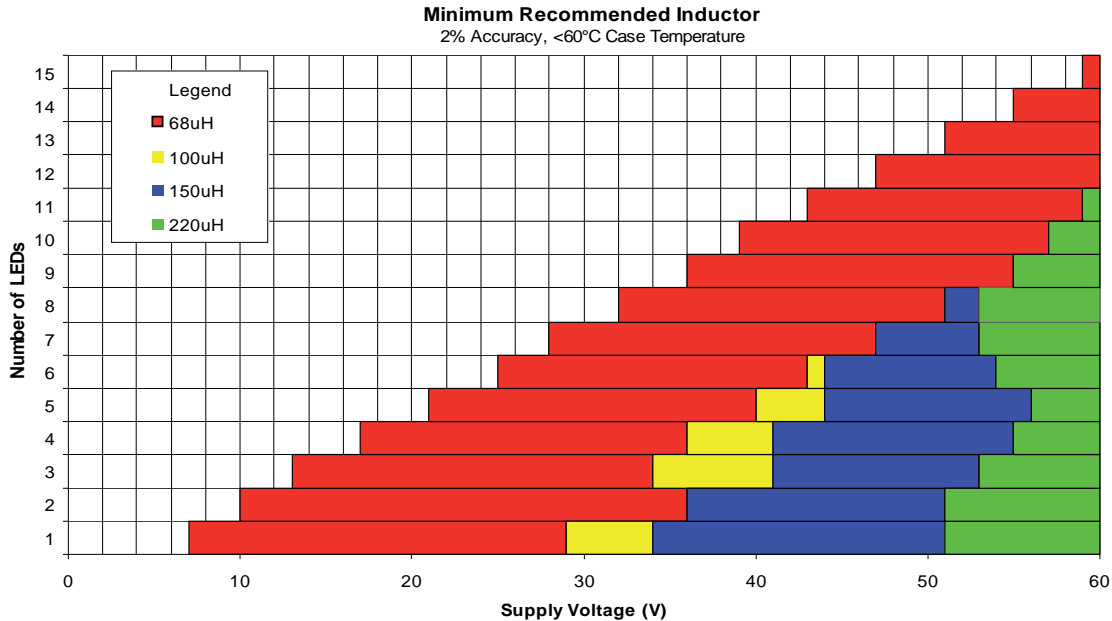

**Figure 3. ZXLD1356 Minimum Recommended Inductor**

**Diode Selection**

For maximum efficiency and performance, the rectifier (D1) should be a fast low capacitance Schottky diode\* with low reverse leakage at the maximum operating voltage and temperature.

They also provide better efficiency than silicon diodes, due to a combination of lower forward voltage and reduced recovery time.

It is important to select parts with a peak current rating above the peak coil current and a continuous current rating higher than the maximum output load current. It is very important to consider the reverse leakage of the diode when operating above 85°C. Excess leakage will increase the power dissipation in the device and if close to the load may create a thermal runaway condition.

The higher forward voltage and overshoot due to reverse recovery time in silicon diodes will increase the peak voltage on the LX output. If a silicon diode is used, care should be taken to ensure that the total voltage appearing on the LX pin including supply ripple, does not exceed the specified maximum value.

\*A suitable Schottky diode would be B1100B (Diodes Inc).

**Application Information** (cont.)

**Reducing Output Ripple**

Peak to peak ripple current in the LED(s) can be reduced, if required, by shunting a capacitor, Cled, across the LED(s) as shown below:

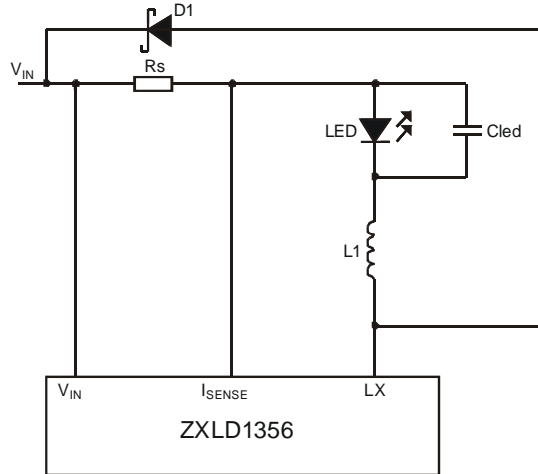

A value of 1 $\mu$ F will reduce the supply ripple current by a factor three (approx.). Proportionally lower ripple can be achieved with higher capacitor values. Note that the capacitor will not affect operating frequency or efficiency, but it will increase start-up delay, by reducing the rate of rise of LED voltage.

By adding this capacitor the current waveform through the LED(s) changes from a triangular ramp to a more sinusoidal version without altering the mean current value.

**Operation at Low Supply Voltage**

Below the under-voltage lockout threshold ( $V_{SD}$ ) the drive to the output transistor is turned off to prevent device operation with excessive on-resistance of the output transistor. The output transistor is not full enhanced until the supply voltage exceeds approximately 17V. At supply voltages between  $V_{SD}$  and 17V care must be taken to avoid excessive power dissipation due to the on-resistance.

Note that when driving loads of two or more LEDs, the forward drop will normally be sufficient to prevent the device from switching below approximately 6V. This will minimize the risk of damage to the device.

**Thermal Considerations**

When operating the device at high ambient temperatures, or when driving maximum load current, care must be taken to avoid exceeding the package power dissipation limits. The graph below gives details for power derating. This assumes the device to be mounted on a (25mm)<sup>2</sup> PCB with 1oz copper standing in still air.

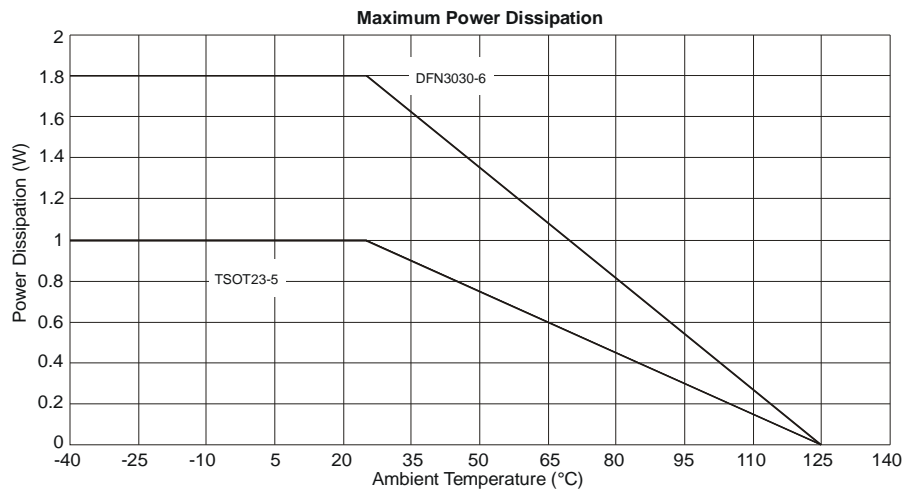



## Application Information (cont.)

### Thermal Considerations (cont.)

Note that the device power dissipation will most often be a maximum at minimum supply voltage. It will also increase if the efficiency of the circuit is low. This may result from the use of unsuitable coils, or excessive parasitic output capacitance on the switch output.

### Thermal Compensation of Output Current

High luminance LEDs often need to be supplied with a temperature compensated current in order to maintain stable and reliable operation at all drive levels. The LEDs are usually mounted remotely from the device so, for this reason, the temperature coefficients of the internal circuits for the ZXLD1356 have been optimized to minimize the change in output current when no compensation is employed. If output current compensation is required, it is possible to use an external temperature sensing network - normally using Negative Temperature Coefficient (NTC) thermistors and/or diodes, mounted very close to the LED(s). The output of the sensing network can be used to drive the ADJ pin in order to reduce output current with increasing temperature.

### Layout Considerations

#### LX pin

The LX pin of the device is a fast switching node, so PCB tracks should be kept as short as possible. To minimize ground 'bounce', the ground pin of the device should be soldered directly to the ground plane.

#### Coil and Decoupling Capacitors and Current Sense Resistor

It is particularly important to mount the coil and the input decoupling capacitor as close to the device pins as possible to minimize parasitic resistance and inductance, which will degrade efficiency. It is also important to minimize any track resistance in series with current sense resistor  $R_S$ . Its best to connect  $V_{IN}$  directly to one end of  $R_S$  and  $I_{sense}$  directly to the opposite end of  $R_S$  with no other currents flowing in these tracks. It is important that the cathode current of the Schottky diode does not flow in a track between  $R_S$  and  $V_{IN}$  as this may give an apparent higher measure of current than is actual because of track resistance.

#### ADJ Pin

The ADJ pin is a high impedance input for voltages up to 1.35V so, when left floating, PCB tracks to this pin should be as short as possible to reduce noise pickup. A 100nF capacitor from the ADJ pin to ground will reduce frequency modulation of the output under these conditions. An additional series 3.3kΩ resistor can also be used when driving the ADJ pin from an external circuit (see below). This resistor will provide filtering for low frequency noise and provide protection against high voltage transients.

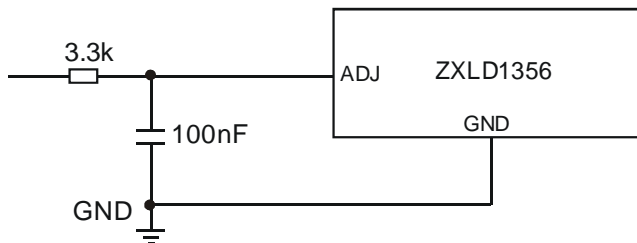

#### High Voltage Tracks

Avoid running any high voltage tracks close to the ADJ pin, to reduce the risk of leakage currents due to board contamination. The ADJ pin is soft-clamped for voltages above 1.35V to desensitize it to leakage that might raise the ADJ pin voltage and cause excessive output current. However, a ground ring placed around the ADJ pin is recommended to minimize changes in output current under these conditions.

#### Evaluation Boards

ZXLD1356 evaluation boards are available on request, which have connection terminals that allow customers to connect their own LED products to the board.

**Application Information** (cont.)

**Dimming Output Current Using PWM**

**Low Frequency PWM Mode**

When the ADJ pin is driven with a low frequency PWM signal (eg 100Hz), with a high level voltage V<sub>ADJ</sub> and a low level of zero, the output of the internal low pass filter will swing between 0V and V<sub>ADJ</sub>, causing the input to the shutdown circuit to fall below its turn-off threshold (200mV nom) when the ADJ pin is low. This will cause the output current to be switched on and off at the PWM frequency, resulting in an average output current I<sub>OUTavg</sub> proportional to the PWM duty cycle. (See Figure 4 - Low frequency PWM operating waveforms).

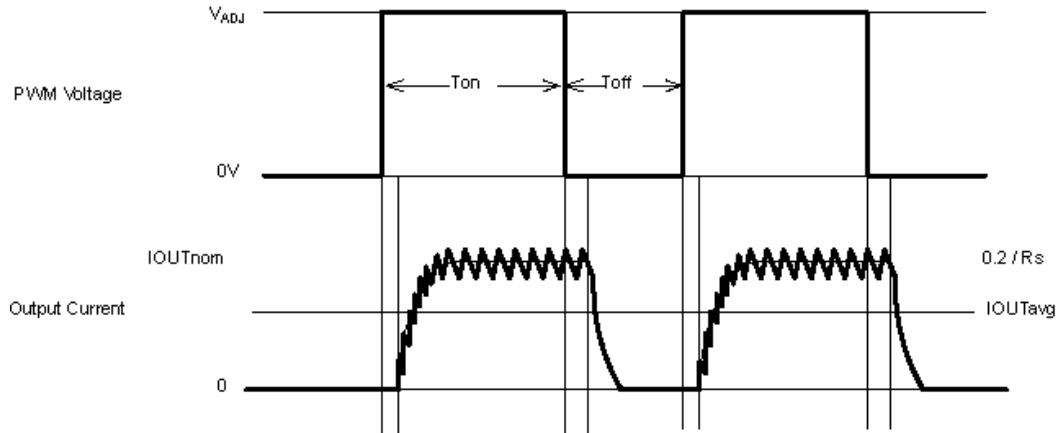

**Figure 4. Low Frequency PWM Operating Waveforms**

The average value of output current in this mode is given by:

$$I_{OUTavg} = \frac{0.2D_{PWM}}{R_S} \quad \text{for } DPWM > 0.001$$

This mode is preferable if optimum LED 'whiteness' is required. It will also provide the widest possible dimming range (approx. 1000:1) and higher efficiency at the expense of greater output ripple.

**ZXLD1356/ ZXLD1356Q**

**Ordering Information**

| Device         | Part mark | Package Code | Packaging   | Reel size (inches) | Reel Width (mm) | Quantity per Reel | Part Number Suffix | Automotive Grade |
|----------------|-----------|--------------|-------------|--------------------|-----------------|-------------------|--------------------|------------------|
| ZXLD1356DACTC  | 1356      | DAC          | V-DFN3030-6 | 13                 | 12              | 3000              | TC                 |                  |
| ZXLD1356ET5TA  | 1356      | ET5          | TSOT25      | 7                  | 8               | 3000              | TA                 |                  |
| ZXLD1356QET5TA | 1356      | ET5          | TSOT25      | 7                  | 8               | 3000              | TA                 | Y (Note 9)       |

Note: 9. For Automotive grade with AEC-Q100 Grade 1 qualification the ZXLD1356QET5TA should be ordered.

**Package Outline Dimensions** (All dimensions in mm.)

Please see AP02002 at <http://www.diodes.com/datasheets/ap02002.pdf> for latest version.

**V-DFN3030-6**

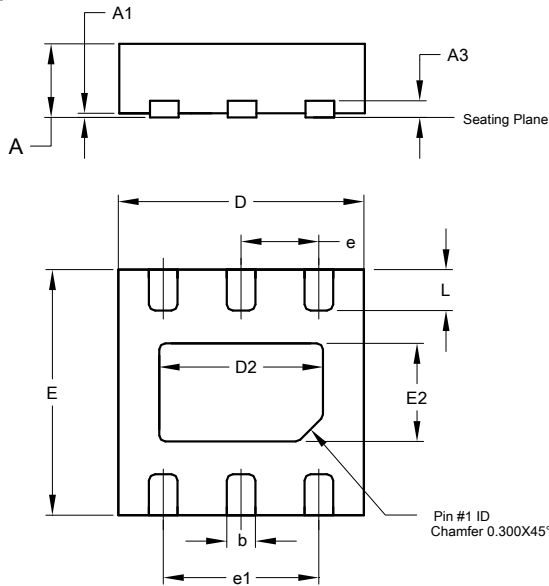

| V-DFN3030-6          |      |      |       |
|----------------------|------|------|-------|
| Dim                  | Min  | Max  | Typ   |
| A                    | 0.80 | 0.90 | 0.85  |
| A1                   | 0    | 0.05 | -     |
| A3                   | -    | -    | 0.203 |
| b                    | 0.30 | 0.40 | 0.35  |
| D                    | 2.95 | 3.05 | 3.00  |
| D2                   | 1.95 | 2.05 | 2.00  |
| E                    | 2.95 | 3.05 | 3.00  |
| E2                   | 1.15 | 1.25 | 1.20  |
| e                    | -    | -    | 0.95  |
| e1                   | -    | -    | 1.90  |
| L                    | 0.45 | 0.55 | 0.50  |
| All Dimensions in mm |      |      |       |

**TSOT25**

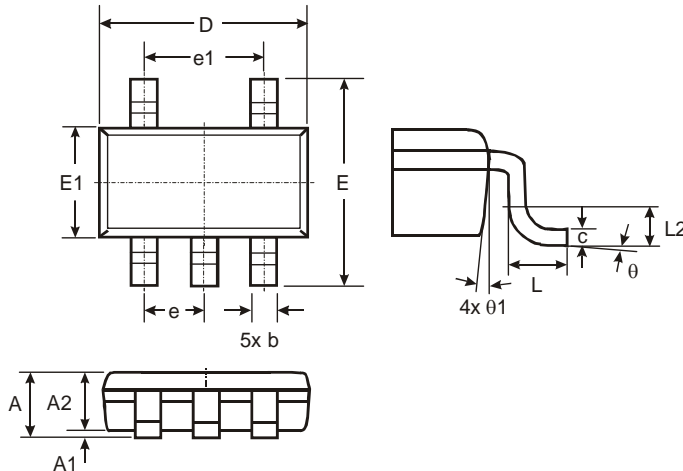

| TSOT25               |      |      |      |
|----------------------|------|------|------|
| Dim                  | Min  | Max  | Typ  |
| A                    | -    | 1.00 | -    |
| A1                   | 0.01 | 0.10 | -    |
| A2                   | 0.84 | 0.90 | -    |
| D                    | -    | -    | 2.90 |
| E                    | -    | -    | 2.80 |
| E1                   | -    | -    | 1.60 |
| b                    | 0.30 | 0.45 | -    |
| c                    | 0.12 | 0.20 | -    |
| e                    | -    | -    | 0.95 |
| e1                   | -    | -    | 1.90 |
| L                    | 0.30 | 0.50 | -    |
| L2                   | -    | -    | 0.25 |
| θ                    | 0°   | 8°   | 4°   |
| θ1                   | 4°   | 12°  | -    |
| All Dimensions in mm |      |      |      |

**ZXLD1356/ ZXLD1356Q**

**Suggested Pad Layout**

Please see AP02001 at <http://www.diodes.com/datasheets/ap02001.pdf> for the latest version.

**V-DFN3030-6**

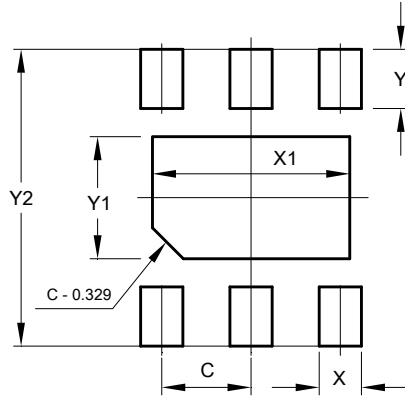

| Dimensions | Value (in mm) |
|------------|---------------|
| C          | 0.950         |
| X          | 0.450         |
| X1         | 2.100         |
| Y          | 0.630         |
| Y1         | 1.300         |
| Y2         | 3.160         |

**TSOT25**

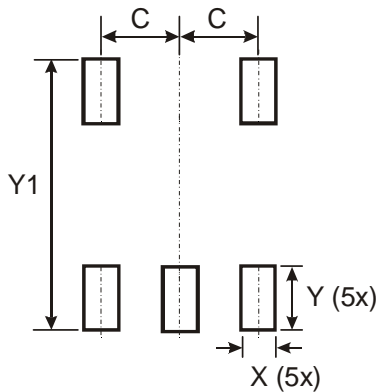

| Dimensions | Value (in mm) |
|------------|---------------|
| C          | 0.950         |
| X          | 0.700         |
| Y          | 1.000         |
| Y1         | 3.199         |

**IMPORTANT NOTICE**

DIODES INCORPORATED MAKES NO WARRANTY OF ANY KIND, EXPRESS OR IMPLIED, WITH REGARDS TO THIS DOCUMENT, INCLUDING, BUT NOT LIMITED TO, THE IMPLIED WARRANTIES OF MERCHANTABILITY AND FITNESS FOR A PARTICULAR PURPOSE (AND THEIR EQUIVALENTS UNDER THE LAWS OF ANY JURISDICTION).

Diodes Incorporated and its subsidiaries reserve the right to make modifications, enhancements, improvements, corrections or other changes without further notice to this document and any product described herein. Diodes Incorporated does not assume any liability arising out of the application or use of this document or any product described herein; neither does Diodes Incorporated convey any license under its patent or trademark rights, nor the rights of others. Any Customer or user of this document or products described herein in such applications shall assume all risks of such use and will agree to hold Diodes Incorporated and all the companies whose products are represented on Diodes Incorporated website, harmless against all damages.

Diodes Incorporated does not warrant or accept any liability whatsoever in respect of any products purchased through unauthorized sales channel.

Should Customers purchase or use Diodes Incorporated products for any unintended or unauthorized application, Customers shall indemnify and hold Diodes Incorporated and its representatives harmless against all claims, damages, expenses, and attorney fees arising out of, directly or indirectly, any claim of personal injury or death associated with such unintended or unauthorized application.

Products described herein may be covered by one or more United States, international or foreign patents pending. Product names and markings noted herein may also be covered by one or more United States, international or foreign trademarks.

This document is written in English but may be translated into multiple languages for reference. Only the English version of this document is the final and determinative format released by Diodes Incorporated.

**LIFE SUPPORT**

Diodes Incorporated products are specifically not authorized for use as critical components in life support devices or systems without the express written approval of the Chief Executive Officer of Diodes Incorporated. As used herein:

A. Life support devices or systems are devices or systems which:

1. are intended to implant into the body, or
2. support or sustain life and whose failure to perform when properly used in accordance with instructions for use provided in the labeling can be reasonably expected to result in significant injury to the user.

B. A critical component is any component in a life support device or system whose failure to perform can be reasonably expected to cause the failure of the life support device or to affect its safety or effectiveness.

Customers represent that they have all necessary expertise in the safety and regulatory ramifications of their life support devices or systems, and acknowledge and agree that they are solely responsible for all legal, regulatory and safety-related requirements concerning their products and any use of Diodes Incorporated products in such safety-critical, life support devices or systems, notwithstanding any devices- or systems-related information or support that may be provided by Diodes Incorporated. Further, Customers must fully indemnify Diodes Incorporated and its representatives against any damages arising out of the use of Diodes Incorporated products in such safety-critical, life support devices or systems.

Copyright © 2012, Diodes Incorporated

[www.diodes.com](http://www.diodes.com)