

**H21A4**

**H21A5**

**H21A6**

**PACKAGE DIMENSIONS**

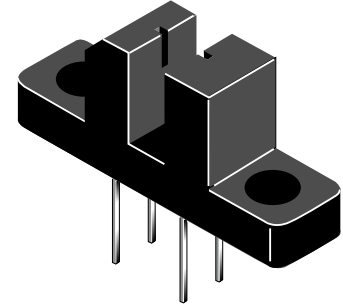
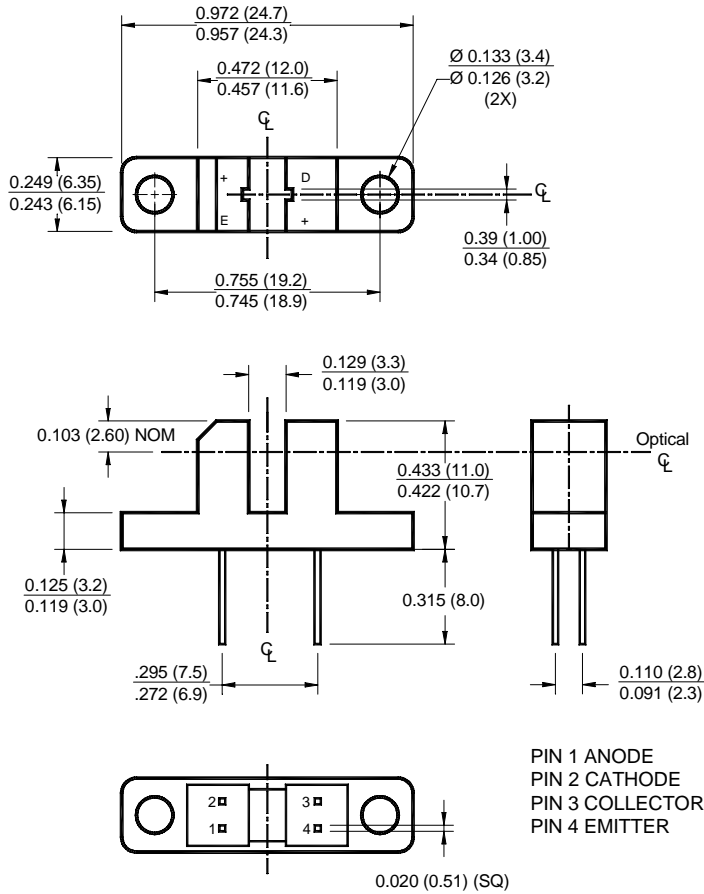

**SCHEMATIC**

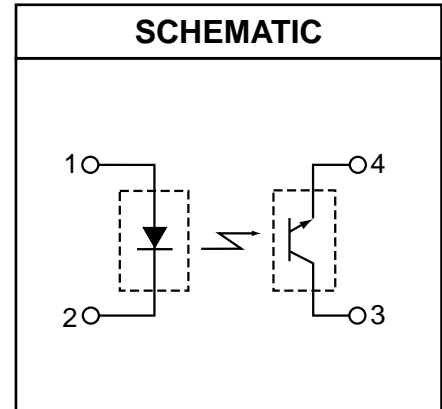

**NOTES:**

1. Dimensions for all drawings are in inches (mm).
2. Tolerance of  $\pm .010$  (.25) on all non-nominal dimensions unless otherwise specified.

**DESCRIPTION**

The H21A series are gallium arsenide infrared emitting diode coupled with a silicon photodarlington in a plastic housing. The packaging system is designed to optimize the mechanical resolution, coupling efficiency, ambient light rejection, cost and reliability. The gap in the housing provides a means of interrupting the signal with an opaque material, switching the output from an "ON" to an "OFF" state.

**FEATURES**

- Opaque housing
- Low cost
- .035" apertures
- High  $I_{C(ON)}$

**H21A4**

**H21A5**

**H21A6**

**ABSOLUTE MAXIMUM RATINGS** ( $T_A = 25^\circ\text{C}$  unless otherwise specified)

Parameter	Symbol	Rating	Unit
Operating Temperature	$T_{OPR}$	-55 to +100	$^\circ\text{C}$
Storage Temperature	$T_{STG}$	-55 to +100	$^\circ\text{C}$
Soldering Temperature (Iron) <sup>(2,3 and 4)</sup>	$T_{SOL-I}$	240 for 5 sec	$^\circ\text{C}$
Soldering Temperature (Flow) <sup>(2 and 3)</sup>	$T_{SOL-F}$	260 for 10 sec	$^\circ\text{C}$
<b>INPUT (EMITTER)</b>			
Continuous Forward Current	$I_F$	50	mA
Reverse Voltage	$V_R$	6	V
Power Dissipation <sup>(1)</sup>	$P_D$	100	mW
<b>OUTPUT (SENSOR)</b>			
Collector to Emitter Voltage	$V_{CEO}$	55	V
Emitter to Collector Voltage	$V_{ECO}$	4.5	V
Collector Current	$I_C$	20	mA
Power Dissipation ( $T_C = 25^\circ\text{C}$ ) <sup>(1)</sup>	$P_D$	150	mW

**NOTE:**

1. Derate power dissipation linearly 1.67 mW/ $^\circ\text{C}$  above 25 $^\circ\text{C}$ .
2. RMA flux is recommended.
3. Methanol or isopropyl alcohols are recommended as cleaning agents.
4. Soldering iron tip 1/16" (1.6mm) minimum from housing.

**ELECTRICAL / OPTICAL CHARACTERISTICS** ( $T_A = 25^\circ\text{C}$ ) (All measurements made under pulse conditions)

PARAMETER	TEST CONDITIONS	SYMBOL	DEVICES	MIN	TYP	MAX	UNITS
<b>INPUT (EMITTER)</b>							
Forward Voltage	$I_F = 60\text{ mA}$	$V_F$	All	—	—	1.7	V
Reverse Breakdown Voltage	$I_R = 10\ \mu\text{A}$	$V_R$	All	6.0	—	—	$\mu\text{A}$
Reverse Leakage Current	$V_R = 3\text{ V}$	$I_R$	All	—	—	1.0	$\mu\text{A}$
<b>OUTPUT (SENSOR)</b>							
Emitter to Collector Breakdown	$I_F = 100\ \mu\text{A}$ , $E_e = 0$	$BV_{ECO}$	All	6.0	—	—	V
Collector to Emitter Breakdown	$I_C = 1\text{ mA}$ , $E_e = 0$	$BV_{CEO}$	All	55	—	—	V
Collector to Emitter Leakage	$V_{CE} = 45\text{ V}$ , $E_e = 0$	$I_{CEO}$	All	—	—	100	nA
<b>COUPLED</b>							
On-State Collector Current	$I_F = 5\text{ mA}$ , $V_{CE} = 5\text{ V}$	$I_{C(ON)}$	H21A4	0.15	—	—	mA
			H21A5	0.30	—	—	
			H21A6	0.60	—	—	
	$I_F = 20\text{ mA}$ , $V_{CE} = 5\text{ V}$		H21A4	1.0	—	—	
			H21A5	2.0	—	—	
			H21A6	4.0	—	—	
	$I_F = 30\text{ mA}$ , $V_{CE} = 5\text{ V}$		H21A4	1.9	—	—	
			H21A5	3.0	—	—	
			H21A6	5.5	—	—	
Saturation Voltage	$I_F = 20\text{ mA}$ , $I_C = 1.8\text{ mA}$	$V_{CE(SAT)}$	H21A5/6	—	—	0.40	V
	$I_F = 30\text{ mA}$ , $I_C = 1.8\text{ mA}$		H21A4	—	—	0.40	V
Turn-On Time	$I_F = 30\text{ mA}$ , $V_{CC} = 5\text{ V}$ , $R_L = 2.5\text{ K}\Omega$	$t_{on}$	All	—	8	—	$\mu\text{s}$
Turn-Off Time	$I_F = 30\text{ mA}$ , $V_{CC} = 5\text{ V}$ , $R_L = 2.5\text{ K}\Omega$	$t_{off}$	All	—	50	—	$\mu\text{s}$

**TYPICAL PERFORMANCE CURVES**

**Figure 1. Output Current vs. Input Current**

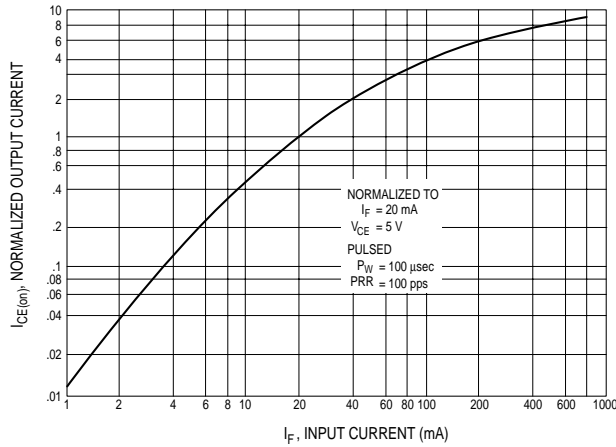

**Figure 2. Output Current vs. Temperature**

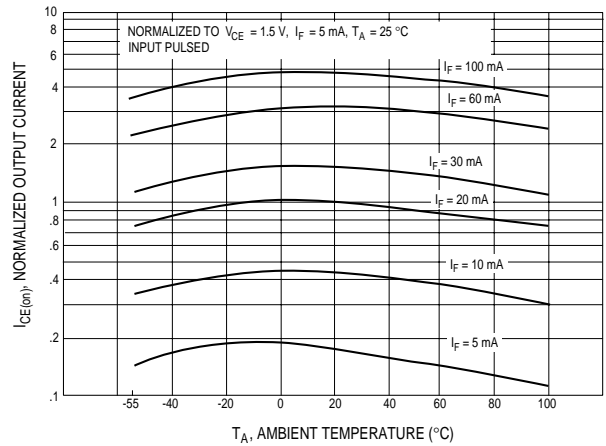

**Figure 3. V<sub>CE(SAT)</sub> vs. Temperature**

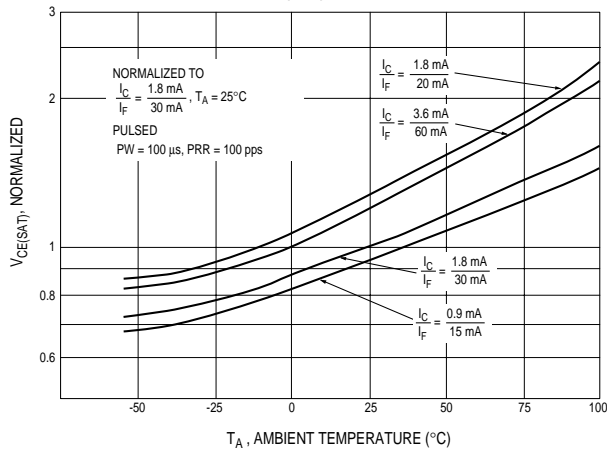

**Figure 4. Leakage Current vs. Temperature**

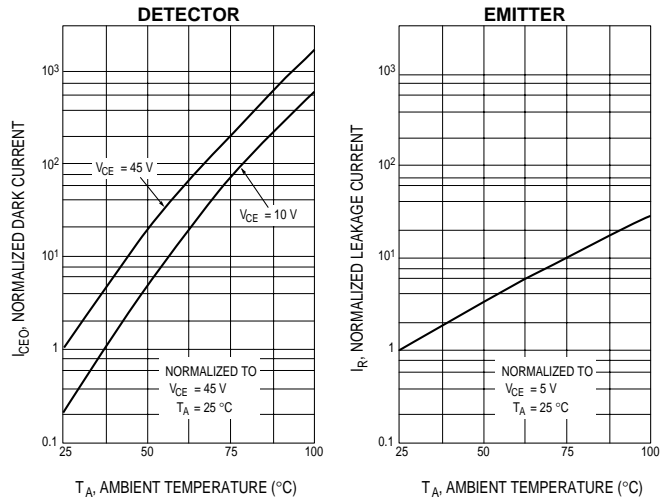

**Figure 5. Switching Speed vs. R<sub>L</sub>**

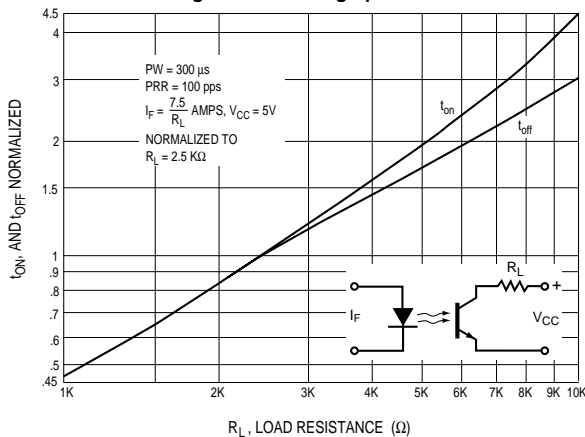

**Figure 6. Output Current vs. Distance**

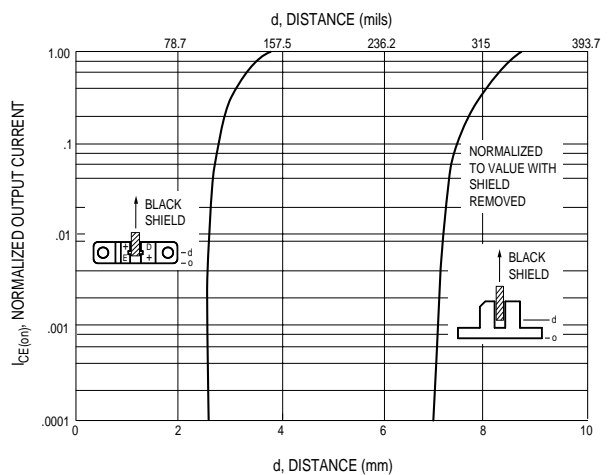

---

**H21A4**

**H21A5**

**H21A6**

---

## **DISCLAIMER**

FAIRCHILD SEMICONDUCTOR RESERVES THE RIGHT TO MAKE CHANGES WITHOUT FURTHER NOTICE TO ANY PRODUCTS HEREIN TO IMPROVE RELIABILITY, FUNCTION OR DESIGN. FAIRCHILD DOES NOT ASSUME ANY LIABILITY ARISING OUT OF THE APPLICATION OR USE OF ANY PRODUCT OR CIRCUIT DESCRIBED HEREIN; NEITHER DOES IT CONVEY ANY LICENSE UNDER ITS PATENT RIGHTS, NOR THE RIGHTS OF OTHERS.

## **LIFE SUPPORT POLICY**

FAIRCHILD'S PRODUCTS ARE NOT AUTHORIZED FOR USE AS CRITICAL COMPONENTS IN LIFE SUPPORT DEVICES OR SYSTEMS WITHOUT THE EXPRESS WRITTEN APPROVAL OF THE PRESIDENT OF FAIRCHILD SEMICONDUCTOR CORPORATION. As used herein:

1. Life support devices or systems are devices or systems which, (a) are intended for surgical implant into the body, or (b) support or sustain life, and (c) whose failure to perform when properly used in accordance with instructions for use provided in labeling, can be reasonably expected to result in a significant injury of the user.
2. A critical component in any component of a life support device or system whose failure to perform can be reasonably expected to cause the failure of the life support device or system, or to affect its safety or effectiveness.