

PGM5549

Features:

- Epoxy Encapsulated
- Reliable Performance
- Quick Response
- Good Characteristic of Spectrum



Applications:

- Industrial Control
- Photoelectric Control
- Photoswitch
- Electronic Toys

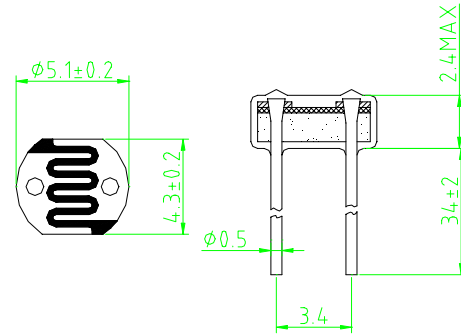

Model	V _{max} (VDC)	P _{max} (mW)	Ambient Temp (°C)	Spectral Peak (nm)	Photo Resistance (10Lx) (KΩ)	Dark Resistance (MΩ)min	γ min	Response Time (ms)	
								Rise	Decay
PGM5549	150	100	-30 ~ +70	540	45 ~ 140	10.0	0.8	20	30

Measuring Conditions

1. Light Resistance:
Measured at 10 lux with standard light A (2854K-color temperature) and 2hr. preillumination at 400-600 lux prior testing.
2. Dark Resistance :
Measured 10 seconds after closed 10 lux.
3. Gamma characteristic:
Between 10 lux and 100 lux and given by

$$\gamma = \frac{\log(R_{10}/R_{100})}{\log(100/10)} = \log(R_{10}/R_{100})$$
 R₁₀,R₁₀: Cell resistance at 10 lux and 100 lux. The tolerance of γ is ±0.1.
4. Pmax:
Max. Power Dissipation at ambient temperature of 25° C.
5. Vmax:
Max. Voltage in Darkness that may be applied to the cell continuously.