

# HF-LPT200

## Low Power WiFi Module User Manual

V 1.3



### Overview of Characteristic

- ◇ Support IEEE802.11b/g/n Wireless Standards
- ◇ Based on Self-developed High Cost Effective MCU
- ◇ Ultra-Low-Power for Battery Applications with Excellent Power Save Scheme
- ◇ Support UART/SPI/GPIO Data Communication Interface
- ◇ Support Work As STA/AP/AP+STA Mode
- ◇ Support Smart Link Function (APP program provide)
- ◇ Support Wireless and Remote Firmware Upgrade Function
- ◇ Support WPS Function
- ◇ Support Multi-TCP Link (5 Channel) Application
- ◇ Support Internal/External Pin Antenna Option
- ◇ Single +3.3V Power Supply
- ◇ Smallest Size: 22mm x 13.5mm x 3mm , SMT17 Package
- ◇ FCC/CE Certificated

## TABLE OF CONTENTS

<b>LIST OF FIGURES</b> .....	<b>6</b>
<b>LIST OF TABLES</b> .....	<b>7</b>
<b>HISTORY</b> .....	<b>8</b>
<b>1. PRODUCT OVERVIEW</b> .....	<b>9</b>
<b>1.1. General Description</b> .....	<b>9</b>
1.1.1 Device Features.....	9
1.1.2 Device Parameters .....	10
1.1.3 Key Application .....	10
<b>1.2. Hardware Introduction</b> .....	<b>11</b>
1.2.1 Pins Definition .....	11
1.2.2 Electrical Characteristics .....	12
1.2.3 Mechanical Size.....	13
1.2.4 On-board Chip Antenna.....	14
1.2.5 External Antenna .....	14
1.2.6 Evaluation Kit.....	14
1.2.7 Order Information.....	16
1.2.8 Hardware Typical Application .....	16
<b>2. FUNCTIONAL DESCRIPTION</b> .....	<b>18</b>
<b>2.1. Wireless Networking</b> .....	<b>18</b>
2.1.1. Basic Wireless Network Based On AP (Infrastructure) .....	18
2.1.2. Wireless Network Based On AP+STA.....	18
<b>2.2. Work Mode : Transparent Transmission Mode</b> .....	<b>19</b>
<b>2.3. UART Frame Scheme</b> .....	<b>20</b>
2.3.1. UART Free-Frame .....	20
2.3.2. UART Auto-Frame.....	20
<b>2.4. Encryption</b> .....	<b>21</b>
<b>2.5. Parameters Configuration</b> .....	<b>21</b>
<b>2.6. Firmware Update</b> .....	<b>21</b>
<b>2.7. SOCKET B Function</b> .....	<b>22</b>
<b>2.8. Multi-TCP Link Connection</b> .....	<b>22</b>
<b>3. OPERATION GUIDELINE</b> .....	<b>24</b>
<b>3.1. Configuration via Web Accessing</b> .....	<b>24</b>
3.1.1. Open Web Management Interface .....	24
3.1.2. Upgrade Software Page .....	25
<b>3.2. HF-LPT200 Usage Introduction</b> .....	<b>25</b>
3.2.1. Software Debug Tools .....	25
3.2.2. Network Connection .....	25
3.2.3. Default Parameter Setting .....	26
3.2.4. Module Debug.....	26

<b>3.3. Typical Application Examples .....</b>	<b>27</b>
3.3.1. Wireless Control Application.....	27
3.3.2. Remote Management Application.....	28
3.3.3. Transparent Serial Port Application.....	28
<b>4. AT+INSTRUCTION INTRODUCTION .....</b>	<b>29</b>
<b>4.1. Configuration Mode .....</b>	<b>29</b>
4.1.1. Switch to Configuration Mode.....	29
<b>4.2. AT+Instruction Set Overview .....</b>	<b>30</b>
4.2.1. Instruction Syntax Format.....	30
4.2.2. AT+Instruction Set .....	31
4.2.2.1. AT+E .....	33
4.2.2.2. AT+WMODE .....	34
4.2.2.3. AT+ENTM .....	34
4.2.2.4. AT+TMODE.....	34
4.2.2.5. AT+MID .....	34
4.2.2.6. AT+VER .....	35
4.2.2.7. AT+LVER .....	35
4.2.2.8. AT+FWSZ .....	35
4.2.2.9. AT+RELD .....	35
4.2.2.10. AT+FCLR.....	35
4.2.2.11. AT+Z.....	36
4.2.2.12. AT+H .....	36
4.2.2.13. AT+CFGRD .....	36
4.2.2.14. AT+CFGWR .....	36
4.2.2.15. AT+CFGFR.....	36
4.2.2.16. AT+CFGTF .....	36
4.2.2.17. AT+UART .....	37
4.2.2.18. AT+UARTF .....	37
4.2.2.19. AT+UARTFT.....	38
4.2.2.20. AT+UARTFL .....	38
4.2.2.21. AT+UARTTE.....	38
4.2.2.22. AT+SEND .....	38
4.2.2.23. AT+RECV .....	39
4.2.2.24. AT+PING .....	39
4.2.2.25. AT+NETP .....	39
4.2.2.26. AT+MAXSK .....	40
4.2.2.27. AT+TCPLK .....	40
4.2.2.28. AT+TCPTO.....	40
4.2.2.29. AT+TCPDIS.....	41
4.2.2.30. AT+SOCKB .....	41
4.2.2.31. AT+TCPDISB .....	42
4.2.2.32. AT+TCPTOB .....	42
4.2.2.33. AT+TCPLKB.....	42
4.2.2.34. AT+UDPLCPT .....	43

4.2.2.35.	AT+SNDB .....	43
4.2.2.36.	AT+RCVB .....	43
4.2.2.37.	AT+WSSSID .....	43
4.2.2.38.	AT+WSKEY .....	44
4.2.2.39.	AT+WANN .....	44
4.2.2.40.	AT+WSMAC .....	44
4.2.2.41.	AT+WSLK .....	45
4.2.2.42.	AT+WSLQ .....	45
4.2.2.43.	AT+WSCAN .....	45
4.2.2.44.	AT+WSDNS .....	45
4.2.2.45.	AT+LANN .....	46
4.2.2.46.	AT+WAP .....	46
4.2.2.47.	AT+WAKEY .....	46
4.2.2.48.	AT+WAMAC .....	47
4.2.2.49.	AT+WADHCP .....	47
4.2.2.50.	AT+WADMN .....	47
4.2.2.51.	AT+WALK .....	48
4.2.2.52.	AT+WALKIND .....	48
4.2.2.53.	AT+PLANG .....	48
4.2.2.54.	AT+UPURL .....	49
4.2.2.55.	AT+UPFILE .....	49
4.2.2.56.	AT+LOGSW .....	49
4.2.2.57.	AT+LOGPORT .....	50
4.2.2.58.	AT+UPST .....	50
4.2.2.59.	AT+WEBU .....	50
4.2.2.60.	AT+MSLP .....	50
4.2.2.61.	AT+NTPRF .....	51
4.2.2.62.	AT+NTPEN .....	51
4.2.2.63.	AT+NTPTM .....	51
4.2.2.64.	AT+NTPSER .....	52
4.2.2.65.	AT+WRMID .....	52
4.2.2.66.	AT+RLDEN .....	52
4.2.2.67.	AT+ASWD .....	52
4.2.2.68.	AT+MDCH .....	53
4.2.2.69.	AT+TXPWR .....	53
4.2.2.70.	AT+SMTLK .....	53
4.2.2.71.	AT+WPS .....	53
4.2.2.72.	AT+WPSBTNEN .....	54
4.2.2.73.	AT+LPTIO .....	54
<b>5.</b>	<b>PACKAGE INFORMATION .....</b>	<b>55</b>
5.1.	Recommended Reflow Profile .....	55
5.2.	Device Handling Instruction (Module IC SMT Preparation) .....	55
5.3.	Shipping Information .....	56

<b>APPENDIX A: HW REFERENCE DESIGN</b> .....	<b>57</b>
<b>APPENDIX B: HTTP PROTOCOL TRANSFER</b> .....	<b>58</b>
<b>B.1. HTTP AT command</b> .....	<b>58</b>
B.1.1. AT+HTTTPURL .....	58
B.1.2. AT+HTTTPTP .....	58
B.1.3. AT+HTTTPPH .....	58
B.1.4. AT+HTTTPCN .....	59
B.1.5. AT+HTTTPUA .....	59
B.1.6. AT+HTTTPDT .....	59
<b>B.2. HTTP Example</b> .....	<b>59</b>
<b>APPENDIX C: REFERENCES</b> .....	<b>61</b>
<b>C.1. High-Flying Mass Production Tool</b> .....	<b>61</b>
<b>C.2. SmartLink APP Config Tool</b> .....	<b>61</b>
<b>C.3. EVK Quick Start Guide</b> .....	<b>61</b>
<b>APPENDIX D: CONTACT INFORMATION</b> .....	<b>62</b>

## LIST OF FIGURES

Figure 1.	HF-LPT200 View .....	11
Figure 2.	HF-LPT200 Pins Map .....	11
Figure 3.	HF-LPT200 Mechanical Dimension.....	13
Figure 4.	HF-LPT200 PCB Symbol Size .....	13
Figure 5.	Suggested Module Placement Region .....	14
Figure 6.	HF-LPT200 Evaluation Kit.....	15
Figure 7.	HF-LPT200 Order Information Typical Application .....	16
Figure 8.	HF-LPT200 Hardware Typical Application .....	16
Figure 9.	HF-LPT200 Basic Wireless Network Structure .....	18
Figure 10.	HF-LPT200 AP+STA Network Structure .....	19
Figure 11.	Socket B function demo .....	22
Figure 12.	Multi-TCP Link Data Transmission Structure .....	23
Figure 13.	Open Web Management page.....	24
Figure 14.	Upgrade SW page .....	25
Figure 15.	STA Interface Debug Connection .....	25
Figure 16.	AP Interface Debug Connection .....	26
Figure 17.	“CommTools” Serial Debug Tools .....	26
Figure 18.	“TCPUDPDbg” Tools Create Connection .....	26
Figure 19.	“TCPUDPDbg” Tools Setting .....	27
Figure 20.	“TCPUDPDbg” Tools Connection .....	27
Figure 21.	Wireless Control Application.....	27
Figure 22.	Remote Management Application.....	28
Figure 23.	Transparent Serial Port Application.....	28
Figure 24.	HF-LPT200 Default UART Port Parameters.....	29
Figure 25.	Switch to Configuration Mode.....	29
Figure 26.	”AT+H” Instruction for Help .....	30
Figure 27.	Reflow Soldering Profile .....	55
Figure 28.	Shipping Information.....	56

## LIST OF TABLES

Table 1	HF-LPT200 Module Technical Specifications .....	10
Table 2	HF-LPT200 Pins Definition.....	11
Table 3	HF-LPT200 External Antenna Parameters .....	14
Table 4	HF-LPT200 Evaluation Kit Interface Description.....	15
Table 8	HF-LPT200 Web Access Default Setting .....	24
Table 9	Error Code Description .....	31
Table 10	AT+Instruction Set List .....	31
Table 11	Reflow Soldering Parameter .....	55

## HISTORY

**Ed. V1.0** 12-20-2013 First Version.

**Ed. V1.0.1** 12-25-2013. Update product view.

**Ed. V1.1** 01-02-2014. Update AT command, add AT+SMTLK、 AT+LPTIO.

**Ed. V1.2** 03-13-2014. Update product view and package. Update AT+TCPDISB, AT+NETP, AT+FCLR.description.

**Ed. V1.3** 05-10-2014. Update GPIO description. Update SDK download. Add “AT+UDPLCPT”, “AT+NTPSER” command. Update Shipping information.



# 1. PRODUCT OVERVIEW

## 1.1. General Description

The HF-LPT200 is a fully self-contained small form-factor, single stream, 802.11b/g/n Wi-Fi module, which provide a wireless interface to any equipment with a Serial/SPI interface for data transfer. HF-LPT200 integrate MAC, baseband processor, RF transceiver with power amplifier in hardware and all Wi-Fi protocol and configuration functionality and networking stack, in embedded firmware to make a fully self-contained 802.11b/g/n Wi-Fi solution for a variety of applications.

The HF-LPT200 employs the world's lowest power consumption embedded architecture. It has been optimized for all kinds of client applications in the home automation, smart grid, handheld device, personal medical application and industrial control that have lower data rates, and transmit or receive data on an infrequent basis.

The HF-LPT200 integrates all Wi-Fi functionality into a low-profile, 22x13.5x 3mm SMT module package that can be easily mounted on main PCB with application specific circuits. Also, module provides built-in antenna, external pad antenna option.

### 1.1.1 Device Features

- Single stream Wi-Fi @ 2.4 GHz with support for WEP security mode as well as WPA/WPA2
- Based on Self-developed High Cost Performance MCU
- Ultra-low-power operation with all kinds of power-save modes.
- Includes all the protocol and configuration functions for Wi-Fi connectivity.
- Support STA/AP/AP+STA Mode
- Support Smart Link Function
- Support Wireless and Remote Firmware Upgrade Function
- Integrated chip antenna, antenna connector options.
- Support WPS.
- Support AT Command Config.
- Compact surface mount module 22mm x 13.5mm x 3mm, SMT17 Package
- Single supply – 3.3V operation.
- Low power RTOS and drivers.
- CE/FCC Certified.
- RoHS compliant.

### 1.1.2 Device Parameters

Table 1 HF-LPT200 Module Technical Specifications

Class	Item	Parameters
Wireless Parameters	Certification	FCC/CE
	Wireless standard	802.11 b/g/n
	Frequency range	2.412GHz-2.484GHz
	Transmit Power	802.11b: +16 +/-2dBm (@11Mbps)
		802.11g: +14 +/-2dBm (@54Mbps)
		802.11n: +13 +/-2dBm (@HT20, MCS7)
	Receiver Sensitivity	802.11b: -93 dBm (@11Mbps ,CCK)
802.11g: -85 dBm (@54Mbps, OFDM)		
802.11n: -82 dBm (@HT20, MCS7)		
Antenna Option	External: Pad interface	
	Internal:On-board Chip antenna	
Hardware Parameters	Data Interface	UART
		SPI, GPIO
	Operating Voltage	2.8~3.6V
	Operating Current	Peak [Continuous TX]: ~200mA
		Normal [WiFi ON/OFF, DTIM=100ms]: Average. ~12mA, Peak: 200mA
		Standby : <200uA(Reserved)
	Operating Temp.	-40°C - 85°C
Storage Temp.	-45°C - 125°C	
Dimensions and Size	22mm×13.5mm×3mm	
Software Parameters	Network Type	STA /AP/STA+AP
	Security Mechanisms	WEP/WPA-PSK/WPA2-PSK
	Encryption	WEP64/WEP128/TKIP/AES
	Update Firmware	Local Wireless, Remote
	Customization	Web Page Upgrade
		Support SDK for application develop
	Network Protocol	IPv4, TCP/UDP/FTP/HTTP
User Configuration	AT+instruction set. Android/ iOS Smart Link APP tools	

### 1.1.3 Key Application

- Remote equipment monitoring
- Asset tracking and telemetry
- Security
- Industrial sensors and controls
- Home automation
- Medical devices

## 1.2. Hardware Introduction

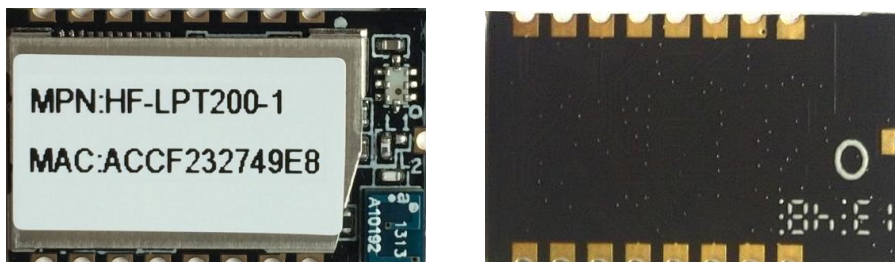

Figure 1. HF-LPT200 View

### 1.2.1. Pins Definition

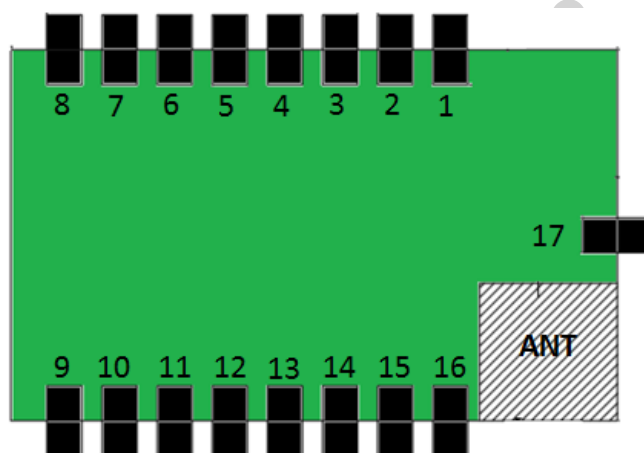

Figure 2. HF-LPT200 Pins Map

Table 2 HF-LPT200 Pins Definition

Pin	Description	Net Name	Signal Type	Comments
1	SPI Data Out	SPI_MOSI	O	GPIO1, No connect if not use.
2	SPI Interface	SPI_CLK	I/O	GPIO2, No connect if not use.
3	SPI Data In	SPI_MISO	I	GPIO3, No connect if not use
4	SPI Interface	SPI_CS	I/O	GPIO4, No connect if not use
5	UART0	UART0_TX	O	GPIO5, No connect if not use
6	UART0	UART0_RX	I	GPIO6, No connect if not use.
7	UART0	UART0_CTS	I/O	GPIO7, No connect if not use.
8	UART0	UART0_RTS	I/O	GPIO8, No connect if not use.
9	GPIO9	GPIO9	I,PU	GPIO9, No connect if not use.
10	Module Reset	EXT_RESETn	I,PU	“Low” effective reset input.
11	Module Boot Up Indicator	nReady	O	“0” – Boot-up OK; “1” – Boot-up No OK;
12	Multi-Function	nReload	I,PU	<b>Detailed functions see &lt;Notes&gt;</b>

Pin	Description	Net Name	Signal Type	Comments
13	Wi-Fi Status	nLink	O	“0” – Wi-Fi connect to router “1” – Wi-Fi unconncted; <b>Detailed functions see &lt;Notes&gt;</b>
14	GPIO14	GPIO14	I/O	Can be used for sleep control or WPS function
15	+3.3V Power	DVDD	Power	Power Input: 2.6~3.6V
16	Ground	GND	Power	
17	2.4GHz Antenna PAD	Ant_2.4G	O	50ohm Impedence

**<Notes>**

**nReload Pin (Button) function:**

1. When this pin is set to “low” during module boot up, the module will enter wireless firmware and config upgrade mode. This mode is used for customer manufacture. (See Appendix C to download software tools for customer batch configuration and upgrade firmware during mass production)
2. After module is powered up, short press this button ( “Low” < 3s ) to make the module go into “Smart Link “ config mode, waiting for APP to set password and other information. (See Appendix C to download SmartLink APP)
3. After module is powered up, long press this button ( “Low” > 3s ) to make the module recover to factory setting.

High-Flying strongly suggest customer fan out this pin to connector or button for “Manufacture” and “ Smart Link” application.

**nLink Pin (LED) function:**

1. At wireless firmware and config upgrade mode , this LED used to indicate configure and upgrade status.
2. At “Smart Link “ config mode, this LED used to indicate APP to finish setting.
3. At normal mode, it’s Wi-Fi link status indicator

High-Flying strongly suggest customer fan out this pin to LED.

**1.2.2. Electrical Characteristics**

Absolute Maximum Ratings:

Parameter	Condition	Min.	Typ.	Max.	Unit
Storage temperature range		-45		125	°C
Maximum soldering temperature	IPC/JEDEC J-STD-020			260	°C
Supply voltage		0		3.8	V
Voltage on any I/O pin		0		3.3	V
ESD (Human Body Model HBM)	TAMB=25°C			2	KV
ESD (Charged Device Model, CDM)	TAMB=25°C			1	KV

Power Supply & Power Consumption:

Parameter	Condition	Min.	Typ.	Max.	Unit
Operating Supply voltage		2.8	3.3	3.8	V
Supply current, peak	Continuous Tx		200		mA
Supply current, IEEE PS	DTIM=100ms		12		mA
Output high voltage	Sourcing 6mA	2.8			V
Output low voltage	Sinking 6mA			0.2	V
Input high voltage		2.2			V
Input low voltage				0.8	V

1.2.3. Mechanical Size

HF-LPT200 modules physical size (Unit: mm) as follows:

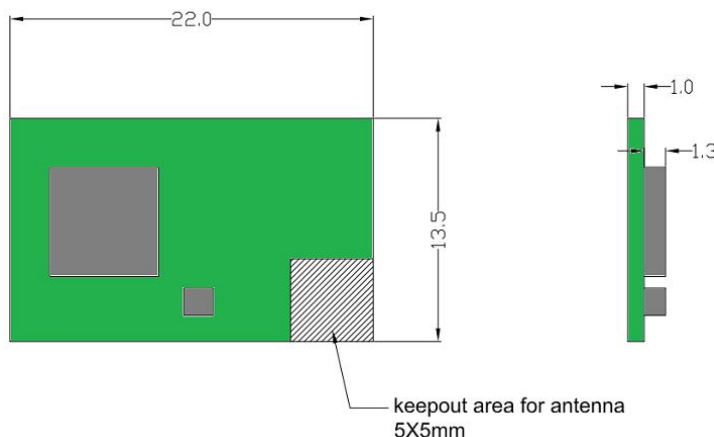

Figure 3. HF-LPT200 Mechanical Dimension

HF-LPT200 Module PCB symbol size (mm) as follows:

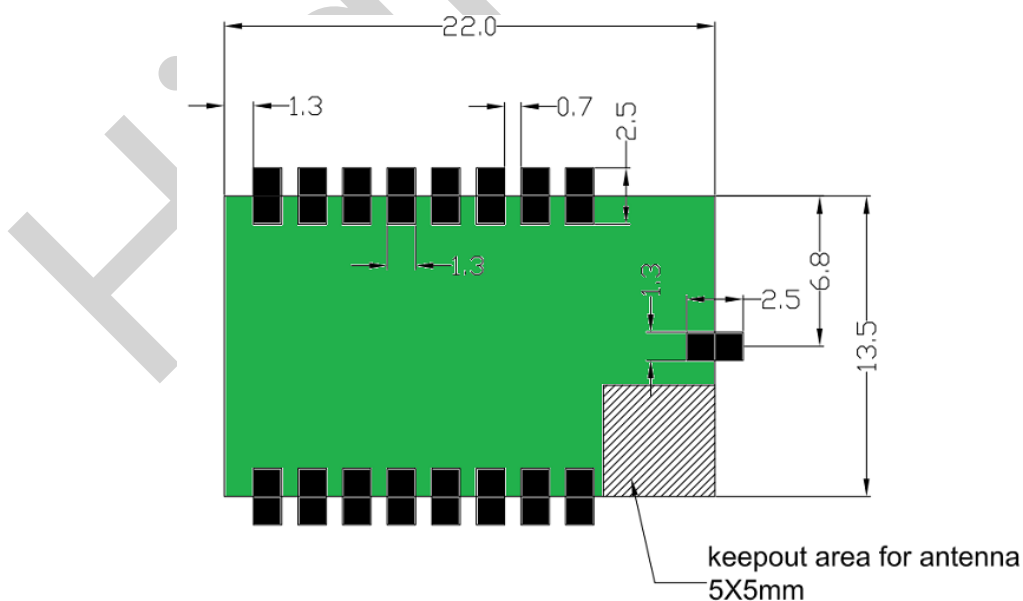

Figure 4. HF-LPT200 PCB Symbol Size

### 1.2.4. On-board Chip Antenna

HF-LPT200 module support internal on-board chip antenna option. When customer select internal antenna, you shall comply with following antenna design rules and module location suggestions:

- For customer PCB, RED color region (8.3x18.4mm) can't put componet or paste GND net;
- Antenna must away from metal or high components at least 10mm;
- Antenna can't be shieldedby any meal enclosure; All cover, include plastic, shall away from antenna at least 10mm;

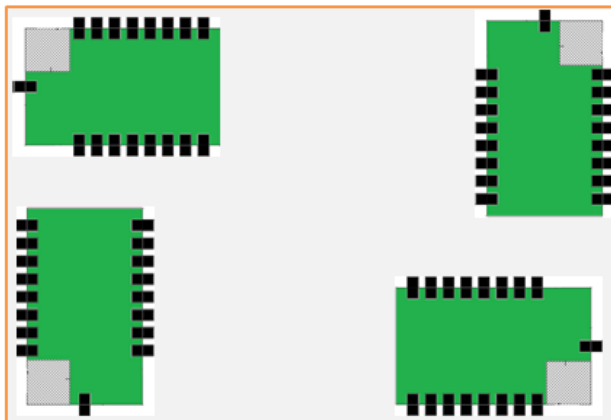

Figure 5. Suggested Module Placement Region

High-Flying suggest HF-LPT200 module better locate in following region at customer board, which to reduce the effect to antenna and wireless signal, and better consult High-Flying technical people when you structure your module placement and PCB layout.

### 1.2.5. External Antenna

HF-LPT200 module supports internal antenna and external antenna(I-PEX or SMA) option for user dedicated application.

If user select external antenna, HF-LPT200 modules must be connected to the 2.4G antenna according to IEEE 802.11b/g/n standards.

The antenna parameters required as follows:

Table 3 HF-LPT200 External Antenna Parameters

Item	Parameters
Frequency range	2.4~2.5GHz
Impedance	50 Ohm
VSWR	2 (Max)
Return Loss	-10dB (Max)
Connector Type	I-PEX or populate directly

### 1.2.6. Evaluation Kit

High-Flying provides the evaluation kit to promote user to familiar the product and develop the detailed application. The evaluation kit shown as below, user can connect to HF-LPT200 module with the RS-232 UART, USB (Internal USB to UART convector) or Wireless interface to configure the parameters, manage the module or do the some functional tests.



Figure 6. HF-LPT200 Evaluation Kit

**Notes:** User need download USB to UART port driver from High-Flying web or contact with technical support people for more detail.

The external interface description for evaluation kit as follows:

Table 4 HF-LPT200 Evaluation Kit Interface Description

Function	Name	Description
External Interface	RS232	Main data/command RS-232 interface
	USB	UART to USB debug interface. (For PC without RS232, need load driver). Can be Power input.
	DC5-18V	DC jack for power in, 5~18V input.
	EXT PORT	HF-LPT200 GPIO function extend interface connector
	JMP	4Pin USB or RS232 Jumper. Left jump select USB.
LED	Power	3.3V Power Indicator
	nLink	nLink -WiFi LINK Indicator <a href="#">See 1.2.1</a>
	nReady	nReady – Module Bootup Ready Indicator On (“low”)- Module bootup OK; Off (“high”)- Mouule botup failed; <a href="#">Twinkle- Remote Upgrade Ongoing;</a>
Button	nReset	Used to reset the module.
	nReload	Restore factory default configuration after push this pin more than 3s. <a href="#">See 1.2.1</a>
	WPS	WPS Button



1.2.7. Order Information

Base on customer detailed requirement, HF-LPT200 series modules provide different variants and physical type for detailed application.

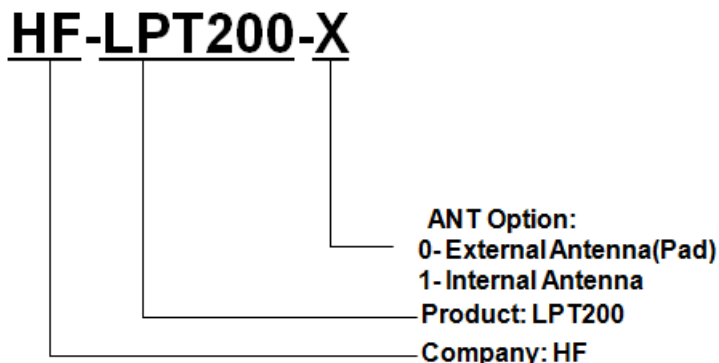

Figure 7. HF-LPT200 Order Information Typical Application

1.2.8. Hardware Typical Application

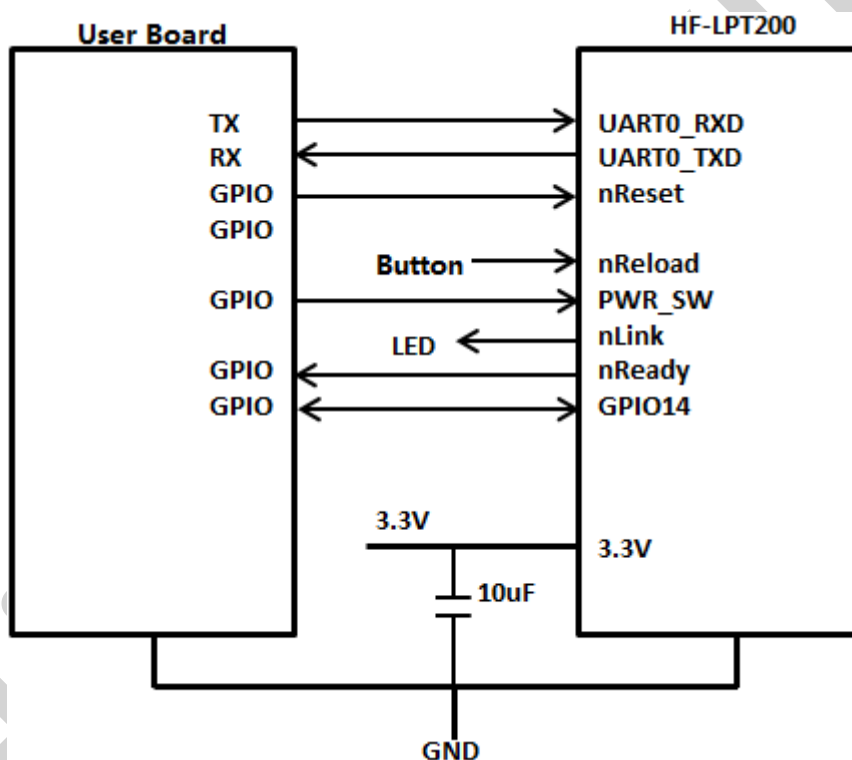

Figure 8. HF-LPT200 Hardware Typical Application

**Notes:**

**nReset-** Module hardware reset signal. Input. Logics “0” effective.

There is pull-up resistor internal and no external pull-up required. When module power up or some issue happened, MCU need assert nRST signal “0” at least 10ms, then set” 1” to keep module fully reset.

**nLink-** Module WIFI connection status indication. Output.



**(This pin is recommend to connect to LED, indicate status when the module in wireless upgrade mode)**

When module connects to AP (AP associated), this pin will output “0”. This signal used to judge if module already at WiFi connection status. There is pull-up resistor internal and no external pull-up required. If nLink function not required, can leave this pin open.

**nReady-** Module boot up ready signal. Output. Logics “0” effective.

The module will output “0” after normal boot up. This signal used to judge if module finish boot up and ready for application or working at normal mode. If nReady function not required, can leave this pin open.

**nReload-** Module restore to factory default configuration. Input. Logics “0” effective.

**(This pin is recommend to connect to button, is used to enter wireless upgrade mode)**

User can de-assert nReload signal “0” more than 3s through button or MCU pin, then release, module will restore to factory default configuration and re-start boot up process.. If nReload function not required, can leave this pin open.

**UART0\_TXD/RXD-** UART port data transmit and receive signal.

## 2. FUNCTIONAL DESCRIPTION

### 2.1. Wireless Networking

HF-LPT200 module can be configured as both wireless STA and AP base on network type. Logically there are two interfaces in HF-LPT200. One is for STA, and another is for AP. When HF-LPT200 works as AP, other STA equipments are able to connect to HF-LPT200 module directly. Wireless Networking with HF-LPT200 is very flexible.

**Notes:**

**AP:** that is the wireless Access Point, the founder of a wireless network and the centre of the network nodes. The wireless router we use at home or in office may be an AP.

**STA:** short for Station, each terminal connects to a wireless network (such as laptops, PDA and other networking devices) can be called with a STA device.

#### 2.1.1. Basic Wireless Network Based On AP (Infrastructure)

Infrastructure: it's also called basic network. It built by AP and many STAs which join in. The characters of network of this type are that AP is the centre, and all communication between STAs is transmitted through the AP. The figure following shows such type of networking.

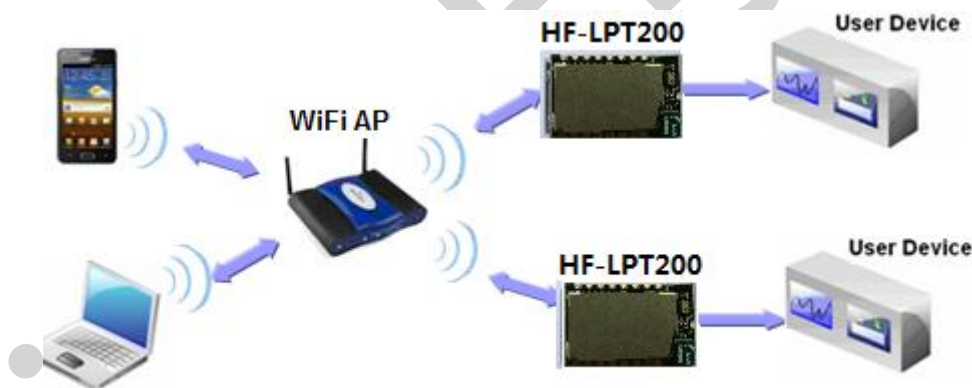

Figure 9. HF-LPT200 Basic Wireless Network Structure

#### 2.1.2. Wireless Network Based On AP+STA

HF-LPT200 module support AP+STA network mode, means module support one AP interface and one STA interface at the same time, as following figure,

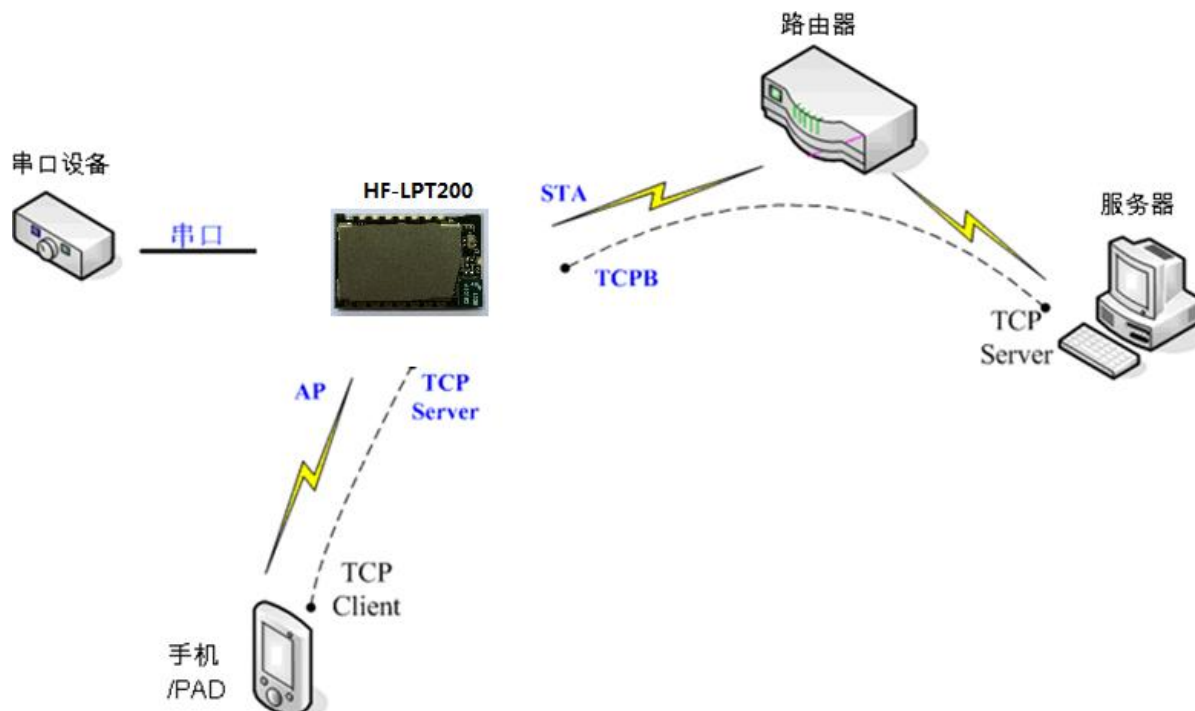

Figure 10. HF-LPT200 AP+STA Network Structure

When module enables AP+STA function, Module’s STA interface can connect with router and connect to TCP server in the network. At the same time, module’s AP interface is also active and permit phone/PAD to connect through TCPB, then phone/PAD can control user device and and setting the module parameters,

The advantage of AP+STA mode is:

- Users can easily setting and track user device through Phone/PAD and not change the original network setting.
- Users can easily setting module’s parameters through WiFi when module works as STA mode.

## 2.2. Work Mode : Transparent Transmission Mode

HF-LPT200 module support serial interface transparent transmission mode. The benefit of this mode is achieves a plug and play serial data port, and reduces user complexity furthest. In this mode, user should only configure the necessary parameters. After power on, module can automatically connect to the default wireless network and server.

As in this mode, the module’s serial port always work in the transparent transmission mode, so users only need to think of it as a virtual serial cable, and send and receive data as using a simple serial. In other words, the serial cable of users’ original serial devices is directly replaced with the module; user devices can be easy for wireless data transmission without any changes.

The transparent transmission mode can fully compatible with user’s original software platform and reduce the software development effort for integrate wireless data transmission.

The parameters which need to configure include:

- **Wireless Network Parameters**
  - Wireless Network Name (SSID)
  - Security Mode
  - Encryption Key
- **TCP/UDP Linking Parameters**
  - Protocol Type
  - Link Type (Server or Client)
  - Target Port ID Number
  - Target Port IP Address
- **Serial Port Parameters**
  - Baud Rate
  - Data Bit
  - Parity (Check) Bit
  - Stop Bit
  - Hardware Flow Control

## 2.3. UART Frame Scheme

### 2.3.1. UART Free-Frame

HF-LPT200 support UART free-frame function. If user select open this function, module will check the intervals between any two bytes when receiving UART data. If this interval time exceeds defined value (50ms default), HF-LPT200 will think it as the end of one frame and transfer this free-frame to WiFi port, or HF-LPT200 will receive UART data until 1000 bytes, then transfer 1000 bytes frame to WiFi port.

HF-LPT200's default interval time is 50ms. User can also set this interval to fast (10ms) through AT command. But user have to consider if user MCU can send UART data with 10ms interval, or the UART data may be divide as fragment.

Through AT command: AT+UARTTE=fash/normal, user can set the interval time: fast (10ms) and normal (50ms).

### 2.3.2. UART Auto-Frame

HF-LPT200 support UART auto-frame function. If user select open this function and setting auto-frame trigger length and auto-frame trigger time parameters, then module will auto framing the data which received from UART port and transmitting to the network as pre-defined data structure.

- **Auto-frame trigger length:** The fixed data length that module used to transmitting to the network.
- **Auto-frame trigger time:** After the trigger time, if UART port received data can't reach auto-frame trigger length, then module will transmitting available data to the network and bypass the auto-frame trigger length condition.

Detailed UART auto-frame function can refer to AT+instruction set “UARTF/UARTFT/UARTFL” introduction.

## 2.4. Encryption

Encryption is a method of scrambling a message that makes it unreadable to unwanted parties, adding a degree of secure communications. There are different protocols for providing encryption, and the HF-LPT200 module supports following:

- ◆ WEP
- ◆ WPA-PSK/TKIP
- ◆ WPA-PSK/AES
- ◆ WPA2-PSK/TKIP
- ◆ WPA2-PSK/AES

## 2.5. Parameters Configuration

HF-LPT200 module supports two methods to configuration parameters: **Web Accessing** and **AT+instruction set**.

Web accessing means users can configure parameters through Web browser. When HF-LPT200 module connected to wireless network, parameters configuration is done on a PC connected to the same wireless network.

AT+instruction set configuration means user configure parameters through serial interface command. Refer to “AT+instruction set” chapter for more detail.

## 2.6. Firmware Update

HF-LPT200 module supports two on-line upgrade methods:

- Webpage Wi-Fi Upgrade
- Remote Upgrade

Webpaged based Wi-Fi upgrade, please refer to 3.1.8 firmware upgrade page, user can upload firmware file from PC to HF-LPT200.

HF-LPT200 module also support upgrade from remote HTTP server, keep module connects to AP router before execute remote HTTP upgrade. Remote upgrade have two methods: **Direct Download and Upgrade**, **Configure File Based Upgrade**.

### ◆ Configure File Based Upgrade

AT+UPURL command to set the remote directory which the configuration file located, such as AT+UPURL=http://www.hi-flying.com/admin/down/

Notes: The last '/' can't be remove

AT+UPFILE command to set the configuration file name, such as AT+UPFILE=config.txt

AT+UPST command to start remote Application upgrade. After execute this command, the module will firstly download configuration file (“config.txt”), then download the upgrade file base on the URL address listed in the configure file.

General “config.txt” file format as following example:

[URL]=<http://10.10.100.100:80/lpb.bin>

[URL]= the URL address of Application.

#### ◆ Direct Download and Upgrade

AT+UPURL command to set the remote directory and file name, such as:

AT+UPURL=<http://www.hi-flying.com/admin/down/lpb.bin>

After execute this command, the module will directly download the “lpb.bin” file from remote directory and start upgrade Application.

**Notes:** please contact with high-flying technical people before upgrade firmware, or maybe damage the module and can't work again.

## 2.7. SOCKET B Function

HF-LPT200 support double socket communication, the socket B function is disabled by default.

After the module is started, send command “AT+SOCKB” to set the connection parameter, send command “AT+TCPDISB=on” to try to connect with TCP server. Send command “AT+TCPDISB=off” to close connection. Send command “AT+TCPLKB” to inquire TCP connection.

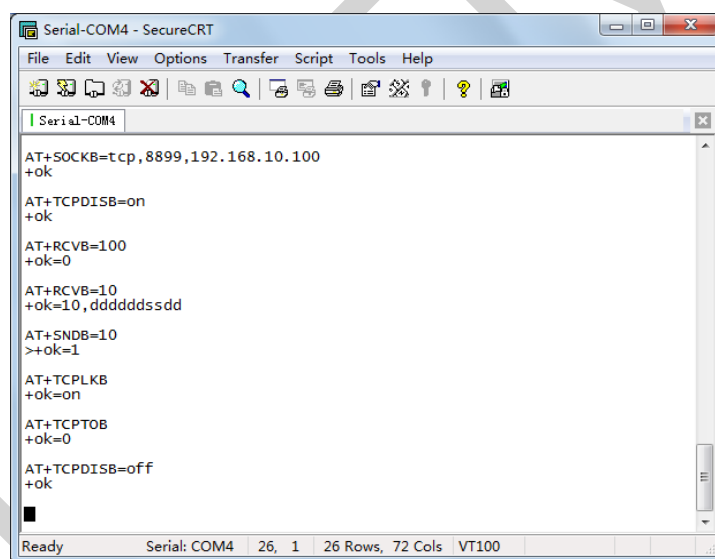

```

Serial-COM4 - SecureCRT
File Edit View Options Transfer Script Tools Help
Serial-COM4
AT+SOCKB=tc,8899,192.168.10.100
+ok
AT+TCPDISB=on
+ok
AT+RCVB=100
+ok=0
AT+RCVB=10
+ok=10,dddddsddd
AT+SNDB=10
>+ok=1
AT+TCPLKB
+ok=on
AT+TCPTOB
+ok=0
AT+TCPDISB=off
+ok
Ready Serial: COM4 26, 1 26 Rows, 72 Cols VT100

```

Figure 11. Socket B function demo

## 2.8. Multi-TCP Link Connection

When HF-LPT200 module configured as TCP Server, it supports Multi-TCP link connection, and maximum 5 TCP clients permitted to connect to HF-LPT200 module. User can realize multi-TCP link connection at each work mode.

Multi-TCP link connection will work as following structure:

Upstream: All dates from different TCP connection or client will be transmitted to the serial port as a sequence.

Downstream: All data from serial port (user) will be duplicate and broadcast to every TCP connection or client.

Detailed multi-TCP link data transmission structure as following figure:

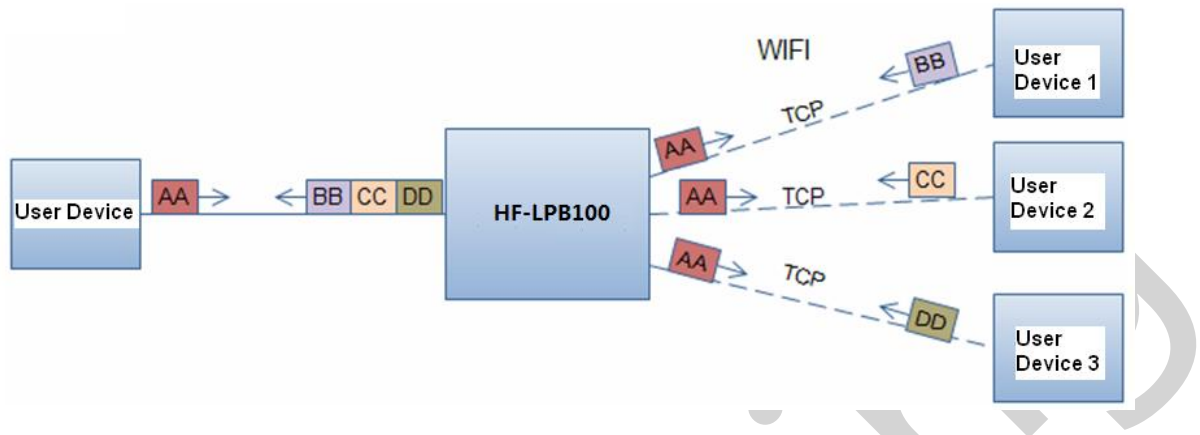

Figure 12. Multi-TCP Link Data Transmission Structure

### 3. OPERATION GUIDELINE

#### 3.1. Configuration via Web Accessing

When first use HF-LPT200 modules, user may need some configuration. User can connect to HF-LPT200 module’s wireless interface with following default setting information and configure the module through laptop.

Table 8 HF-LPT200 Web Access Default Setting

Parameters	Default Setting
SSID	HF-LPB100
IP Address	10.10.100.254
Subnet Mask	255.255.255.0
User Name	Admin
Password	Admin

##### 3.1.1. Open Web Management Interface

Step 1: Connect laptop to SSID “HF-LPT200” of HF-LPT200 module via wireless LAN card;

Step 2: After wireless connection OK. Open Wen browser and access

“<http://10.10.100.254/iweb.html>”;

Step 3: Then input user name and password in the page as following and click “OK” button.



Figure 13. Open Web Management page

The web management interface is for upgrade module software.



### 3.1.2. Upgrade Software Page

User can upgrade new software (firmware) version through Wi-Fi.



Figure 14. Upgrade SW page

## 3.2. HF-LPT200 Usage Introduction

### 3.2.1. Software Debug Tools

High-Flying use two common software tools debugging and applying HF-LPT200 module. (User can also select other tools used to debug serial port).

- Serial Debugging Software: ComTools **ComTools.exe**
- Ethernet Debugging Software: TCPUDPDbg **TCPUDPDbg.exe**

### 3.2.2. Network Connection

User can select two methods to connect HF-LPT200 module base on dedicated application.

- **Use HF-LPT200 STA interface.** HF-LPT200 and debug PC2 connect to a wireless AP, another PC1 (or user device) connect to HF-LPT200 module with serial port:



Figure 15. STA Interface Debug Connection

- **Use HF-LPT200 AP interface.** Debug PC2 connect to HF-LPT200 through wireless

- connection, another PC1 (or user device) connect to HF-LPT200 module with serial port.



Figure 16. AP Interface Debug Connection

### 3.2.3. Default Parameter Setting

- Default SSID: HF-LPB100;
- Deault security mode: open,none;
- User UART parameter setting:115200,8,1,None;
- Default network parameter setting:TCP,Server,8899,10.10.100.254;
- Module IP address: dhcp,0.0.0.0,0.0.0.0,0.0.0.0;

### 3.2.4. Module Debug

PC1 open “CommTools” program, setting the same serial port parameters with HF-LPT200 module and open serial port connection.

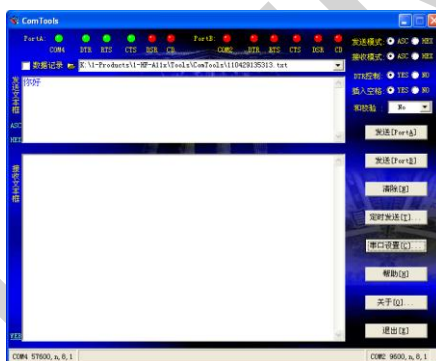

Figure 17. “CommTools” Serial Debug Tools

PC2 open “TCPUDPDbg” program, and create a new connection. If HF-LPT200 configured as Server mode, “TCPUDPDbg” Tools shall create “Client” mode connection. Or otherwise, create a “Server” mode connection.

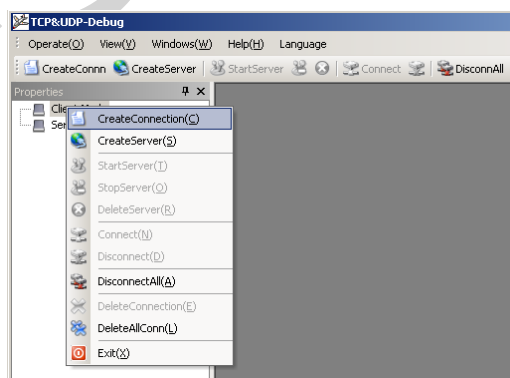

Figure 18. “TCPUDPDbg” Tools Create Connection

Then setting the TCP/UDP connection parameters. Default as following:

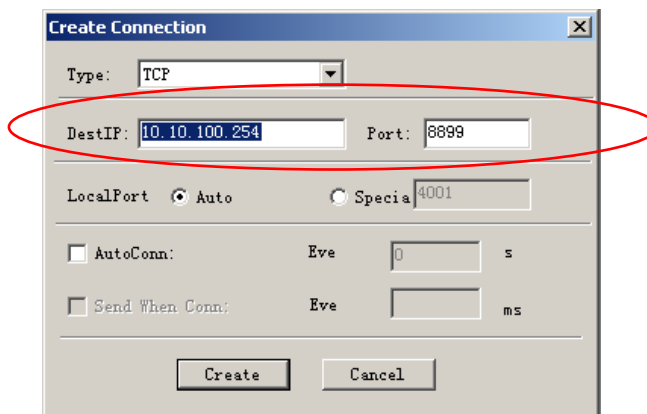

Figure 19. "TCPUDPDbg" Tools Setting

Then, click "Create" button to create a connection.

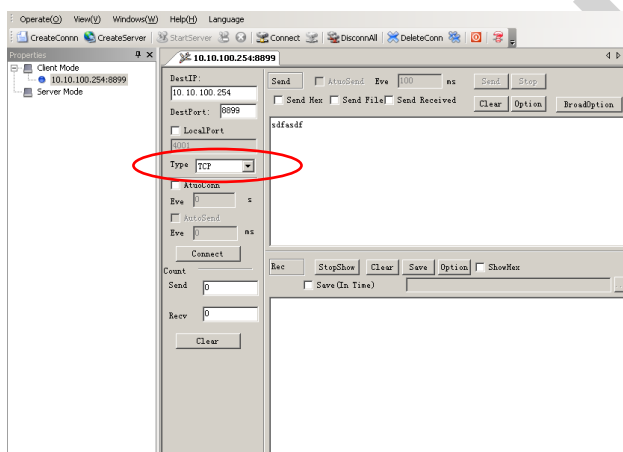

Figure 20. "TCPUDPDbg" Tools Connection

Now, in transparent transmission mode, data can be transferred from "CommTools" program to "TCPUDPDbg" program, or in reverse. You can see data in receiver side will keep same as in sender side.

### 3.3. Typical Application Examples

#### 3.3.1. Wireless Control Application

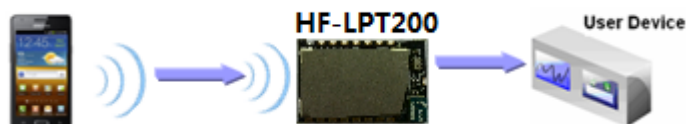

Figure 21. Wireless Control Application

For this wireless control application, HF-LPT200 works as AP mode. Module’s serial port connects to user device. So, control agent (Smart phone for this example) can manage and control the user device through the wireless connection with HF-LPT200 module.

### 3.3.2. Remote Management Application

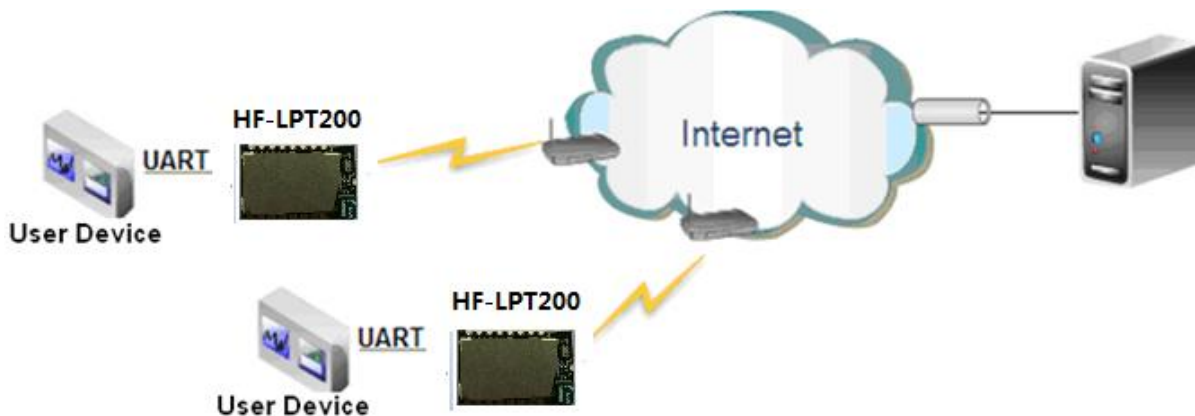

Figure 22. Remote Management Application

For this remote management application, HF-LPT200 works as STA mode and connects to Internet through wireless AP. Module configured as TCP Client and communicates with remote TCP server at Internet. Module’s serial port connects to user device.

So, user device’s data or sampling information can send to remote TCP server for storage or processing. Also remote TCP server can send command to control and manage the user device through the wireless network.

### 3.3.3. Transparent Serial Port Application

For this transparent serial port application, two HF-LPB100 modules connect as below figures to build up a transparent serial port connection. One HF-LPB100 works as AP mode, another HF-LPB100 works as STA mode. Make the STA device connects to AP.



Figure 23. Transparent Serial Port Application

## 4. AT+INSTRUCTION INTRODUCTION

### 4.1. Configuration Mode

When HF-LPT200 power up, it will default works as transparent transmission mode, then user can switch to configuration mode by serial port command. HF-LPT200 UART default parameters setting as below figure,

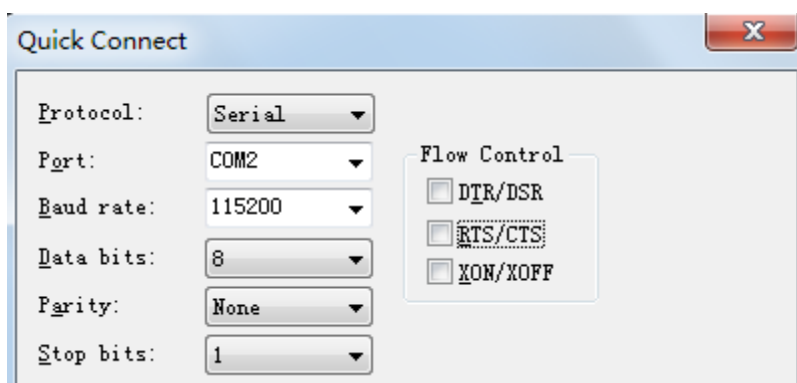

Figure 24. HF-LPT200 Default UART Port Parameters

In configuration mode, user can setting the module through AT+instruction set, which cover all web page setting function.

#### 4.1.1. Switch to Configuration Mode

Two steps to finish switching from transparent transmission mode to configuration mode.

- **UART input “+++”, after module receive “+++”, and feedback “a” as confirmation.**
- **UART input “a”, after module receive “a” and feedback “+ok” to go into AT+instruction set configuration mode.**

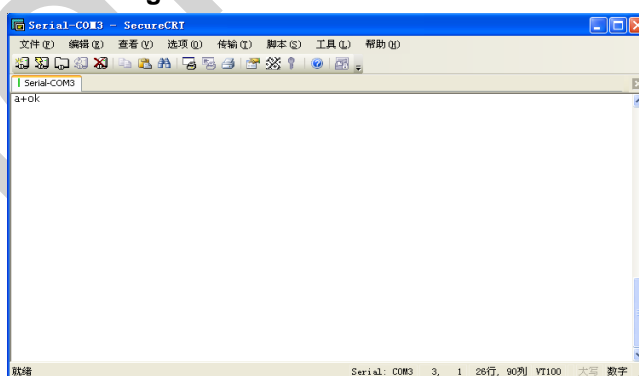
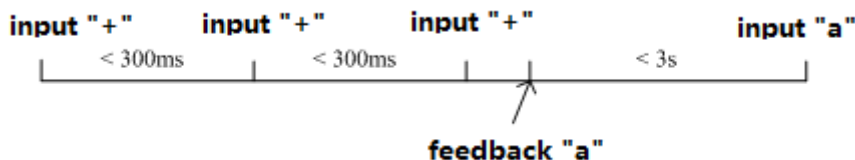

Figure 25. Switch to Configuration Mode

#### **Notes:**

1. When user input “+++” (No “Enter” key required), the UART port will display feedback information “a”, and not display input information “+++” as above UART display.

2. Any other input or wrong step to UART port will cause the module still works as original mode (transparent transmission).
3. “+++” and “a” should be input in a certain period of time to make the module switch to configuration mode. Like the following sequence.



## 4.2. AT+Instruction Set Overview

User can input AT+Instruction through hyper terminal or other serial debug terminal, also can program the AT+Instruction to script. User can also input “AT+H” to list all AT+Instruction and description to start.

```

AT+H
+ok

AT+: NONE command, reply "+ok".
AT+ASWD: Set/Query wiFi configuration code.
AT+E: Echo ON/off, to turn on/off command line echo function.
AT+ENTM: Goto Through Mode.
AT+NETP: Set/Get the Net Protocol Parameters.
AT+UART: Set/Get the UART Parameters.
AT+UARTF: Enable/disable UART AutoFrame function.
AT+UARTFT: Set/Get time of UART AutoFrame.
AT+UARTFL: Set/Get frame length of UART AutoFrame.
AT+UARTTE: Set/Query UART free-frame triggerf time between two byte.
AT+PING: General PING command.
AT+WAP: Set/Get the AP parameters.
AT+WKEY: Set/Get the Security Parameters of WIFI AP Mode.
AT+WMODE: Set/Get the WIFI Operation Mode (AP or STA).
AT+WKEY: Set/Get the Security Parameters of WIFI STA Mode.
AT+WSSID: Set/Get the AP's SSID of WIFI STA Mode.
AT+WSLK: Get Link Status of the Module (only for STA Mode).
AT+WSQL: Get Link Quality of the Module (only for STA Mode).
AT+WSCAN: Get The AP site Survey (only for STA Mode).
AT+WEBU: Set/Get the Login Parameters of WEB page.
AT+TCPK: Get The state of TCP link.
AT+TCPTO: Set/Get TCP time out.
AT+TCPDIS: Connect/Dis-connect the TCP Client link
AT+RECV: Recv data from UART
AT+SEND: Send data to UART
AT+WANN: Set/Get The WAN setting if in STA mode.
AT+LANN: Set/Get The LAN setting if in ADHOC mode.
AT+RELD: Reload the default setting and reboot.
AT+RLDEN: Put on/off the GPIO12.
AT+Z: Reset the Module.
AT+MID: Get The Module ID.
AT+VER: Get application version.
AT+H: Help.
    
```

Figure 26. “AT+H” Instruction for Help

### 4.2.1. Instruction Syntax Format

AT+Instruction protocol is based on the instruction of ASCII command style, the description of syntax format as follow.

- **Format Description**
  - <>: Means the parts must be included
  - [: Means the optional part
- **Command Message**

**AT+<CMD>[op][para-1,para-2,para-3,para-4...]<CR>**

- AT+: Prefix of command message;
- CMD: Command string;
- [op]: Symbol of command operator,
  - ◆ “=” : The command requires parameters input;
  - ◆ “NULL”: Query the current command parameters setting;
- [para-n]: Parameters input for setting if required;
- <CR>: “Enter” Key, it’s 0x0a or 0x0d in ASCII;

**Notes:** When input AT+Instruction, “AT+<CMD>” character will display capital letter automatic and other parts will not change as you input.

➤ **Response Message**

**+<RSP>[op] [para-1,para-2,para-3,para-4...]<CR><LF><CR><LF>**

- +: Prefix of response message;
- RSP: Response string;
  - ◆ “ok” : Success
  - ◆ “ERR”: Failure
- [op] : =
- [para-n]: Parameters if query command or Error code when error happened;
- <CR>: ASCII 0x0d;
- <LF>: ASCII 0x0a;

➤ **Error Code**

Table 9 Error Code Description

Error Code	Description
-1	Invalid Command Format
-2	Invalid Command
-3	Invalid Operation Symbol
-4	Invalid Parameter
-5	Operation Not Permitted

4.2.2. AT+Instruction Set

Table 10 AT+Instruction Set List

Instruction	Description
<null>	NULL
<b>Management Instruction Set</b>	
E	Open/Close show back function
WMODE	Set/Query Wi-Fi work mode (AP/STA/APSTA)
ENTM	Set module into transparent transition mode
TMODE	Set/Query module data transfer mode

Instruction	Description
MID	Query module ID information
VER	Query module software version information
LVER	Query module detailed software version
FWSZ	Query Wi-Fi driver size
RELD	Restore to factory default setting
FCLR	Erase factory setting
Z	Re-start module
H	Help
<b>Configure Parameters Instruction Set</b>	
CFGRD	Batch Read User Configure Parameters
CFGWR	Batch Write Configure Parameters
CFGFR	Batch Read Factory Default Configure Parameters
CFGTF	Copy User Parameters to Factory Default Parameters
<b>UART Instruction Set</b>	
UART	Set/Query serial port parameters
UARTFT	Open/Close UART auto-frame function
UARTFT	Set/Query UART auto-frame trigger time
UARTFL	Set/Query UART auto-frame trigger length
UARTTE	Set/Query UART free-frame trigger time between two bytes
<b>Command Mode Set</b>	
SEND	Send Data at Command Mode
RECV	Receive Data at Command Mode
<b>Network Instruction Set</b>	
PING	Network "Ping" Instruction
NETP	Set/Query network protocol parameters
MAXSK	Set/Query TCP Client connection number
TCPLK	Query if TCP link already build-up
TCPTO	Set/Query TCP timeout
TCPDIS	Open/Close TCP link
SOCKB	Set/Query SOCKB parameters
TCPDISB	Open/Close SOCKB TCP link
TCPTOB	Set/Query SOCKB TCP timeout
TCPLKB	Query if SOCKB TCP link already build-up
UDPLCPT	Set/Query UDP local port
SNDB	Send data to SOCKB in Command Mode
RCVB	Receive data from SOCKB in Command Mode
<b>Wi-Fi STA Instruction Set (Effective when module works as STA)</b>	
WSKEY	Set/Query STA security parameters
WSSID	Set/Query associated AP SSID parameters
WANN	Set/Query STA's network parameters
WSMAC	Set/Query STA's MAC address
WSLK	Query STA Wi-Fi link status
WSLQ	Query STA Wi-Fi signal strength
WSCAN	Scan AP
WSDNS	Set/Query STA's Static DNS server address
<b>Wi-Fi AP Instruction Set (Effective when module works as AP)</b>	
LANN	Set/Query AP's network parameters
WAP	Set/Query AP Wi-Fi parameters
WAKEY	Set/Query AP security parameters



Instruction	Description
WAMAC	Set/Query AP MAC address
WADHCP	Set/Query AP DHCP Server status
WADMN	Set/Query AP webpage domain name
WALK	Query MAC address of STA device connecting to module AP
WALKIND	Enable/Disable indication of connection status.
<b>Webpage Management Instruction Set</b>	
PLANG	Set/Query Webpage Language Option
WEBU	Set/Query Webpage User name and Code
<b>Remote Upgrade Instruction Set</b>	
UPURL	Set/Query remote upgrade URL address
UPFILE	Set/Query remote upgrade configure file name
LOGSW	Open/Close remote upgrade log
LOGPORT	Set/Query UDP port of remote upgrade log
UPST	Start remote Application upgrade
<b>Power Management Instruction Set</b>	
MSLP	Set/Query deep sleep/standby mode parameters
<b>Network Time Set</b>	
NTPRF	Set/Query time calibration interval
NTPEN	Enable/Disable time calibration function
NTPTM	Query time
NTPSER	Set/Query NTP server IP
<b>Others Instruction Set</b>	
WRMID	Set module ID
RLDEN	Set/Query GPIO45 status
ASWD	Set/Query WiFi configuration code
MDCH	Set Wi-Fi Auto Switch Function
TXPWR	Set/Query Wi-Fi Transmit Power
SMTLK	Start SmartLink function
WPS	Start WPS function
WPSTNEN	Enable/Disable GPIO 15 WPS function
LPTIO	nRead/nLink/WPS function mapping

**WiFi Config Tools don't support "CFGRD" command yet.**

4.2.2.1. AT+E

- Function: Open/Close show back function;
- Format:
  - ◆ Set Operation
  - AT+E=<status><CR>**
  - +ok<CR><LF><CR><LF>**
- Parameters:
  - ◆ status: Echo status
    - ✧ on: Open echo
    - ✧ off: Close echo

When HF-LPB100 module firstly switch from transparent transmission to configuration mode, show back status is open, input "AT+E" to close show back function, input "AT+E" again to open show back function.

## 4.2.2.2. AT+WMODE

- Function: Set/Query Wi-Fi work mode. Setting is valid after reset;

- Format:

- ◆ Query Operation

**AT+WMODE<CR>**

**+ok=<mode><CR><LF><CR><LF>**

- ◆ Set Operation

**AT+WMODE=<mode><CR>**

**+ok<CR><LF><CR><LF>**

- Parameters:

- ◆ mode:Wi-Fi work mode

- ◇ AP
- ◇ STA
- ◇ APSTA

## 4.2.2.3. AT+ENTM

- Function: Set module into transparent transmission mode;

- Format:

**AT+ENTM<CR>**

**+ok<CR><LF><CR><LF>**

When operate this command, module switch from configuration mode to transparent transmission mode.

## 4.2.2.4. AT+TMODE

- Function: Set/Query module data transfer mode. Setting is valid after reset.

- Format:

- ◆ Query Operation

**AT+TMODE<CR>**

**+ok=<tmode><CR><LF><CR><LF>**

- ◆ Set Operation

**AT+TMODE=<tmode><CR>**

**+ok<CR><LF><CR><LF>**

- Parameters:

- ◆ tmode: data transfer mode, include:

- ◇ throughput: throughput mode
- ◇ cmd: command mode
- ◇ pwm: PWM/GPIO mode

## 4.2.2.5. AT+MID

- Function: Query module ID information;

- Format:

- ◆ Query Operation

**AT+MID<CR>**

**+ok=<module\_id><CR><LF><CR><LF>**

- Parameters:
  - ◆ module\_id: Module ID information;
    - ◇ HF-LPB100;

Notes: User can set this parameter through AT+WRMID.

#### 4.2.2.6. AT+VER

- Function: Query module software version information;
  - Format:
    - ◆ Query Operation
- ```
AT+VER<CR>
+ok=<ver><CR><LF><CR><LF>
```
- Parameters:
    - ◆ ver: Module software version information;

#### 4.2.2.7. AT+LVER

- Function: Query module detailed software version information;
  - Format:
    - ◆ Query Operation
- ```
AT+LVER<CR>
+ok=<ver><CR><LF><CR><LF>
```
- Parameters:
    - ◆ ver: Module software detailed version information;

#### 4.2.2.8. AT+FWSZ

- Function: Query Wi-Fi driver size;
  - Format:
    - ◆ Query Operation
- ```
AT+FWSZ<CR>
+ok=<size><CR><LF><CR><LF>
```
- Parameters:
    - ◆ size: Wi-Fi driver size.(Byte)

#### 4.2.2.9. AT+RELD

- Function: module restore to factory default setting;
  - Format:
    - ◆ Set Operation
- ```
AT+RELD<CR>
+ok=rebooting...<CR><LF><CR><LF>
```

When operate this command, module will restore to factory default setting and reboot.

#### 4.2.2.10. AT+FCLR

- Function: Erase factory setting;
  - Format:
    - ◆ Query Operation
- ```
AT+FCLR<CR>
```

**+ok=<status><CR><LF><CR><LF>**

#### 4.2.2.11. AT+Z

- Function: Re-start module;
- Format:

**AT+Z<CR>**

#### 4.2.2.12. AT+H

- Function: Help;
- Format:
  - ◆ Query Operation

**AT+H<CR>**

**+ok=<command help><CR><LF><CR><LF>**

- Parameters:
  - ◆ command help: command introduction;

#### 4.2.2.13. AT+CFGRD

- Function: Batch Read User Configure Parameters;
- Format:
  - ◆ Query Operation

**AT+CFGRD<CR>**

**+ok=<config><CR><LF><CR><LF>**

- Parameters:
  - ◆ config: the first two bytes means the length of configuration parameters;

#### 4.2.2.14. AT+CFGWR

- Function: Batch Write User Configure Parameters;
- Format:
  - ◆ Set Operation

**AT+CFGWR=<config><CR>**

**+ok<CR><LF><CR><LF>**

- Parameters:
  - ◆ config: the first two bytes means the length of configuration parameters;

#### 4.2.2.15. AT+CFGFR

- Function: Batch Read Factory Default Configure Parameters;
- Format:
  - ◆ Query Operation

**AT+CFGFR<CR>**

**+ok=<config><CR><LF><CR><LF>**

- Parameters:
  - ◆ config: the first two bytes means the length of configuration parameters;

#### 4.2.2.16. AT+CFGTF

- Function: Copy User Parameters to Factory Default Parameters;

- Format:
    - ◆ Query Operation
- AT+CFGTF<CR>**  
**+ok=<status><CR><LF><CR><LF>**
- Parameters:
    - ◆ status: feedback operation status;

4.2.2.17. AT+UART

- Function: Set/Query serial port parameters. Setting is valid after reset.
  - Format:
    - ◆ Query Operation
- AT+UART<CR>**  
**+ok=<baudrate,data\_bits,stop\_bit,parity><CR><LF><CR><LF>**
- ◆ Set Operation
- AT+UART=<baudrate,data\_bits,stop\_bit,parity><CR>**  
**+ok<CR><LF><CR><LF>**
- Parameters:
    - ◆ baudrate:
      - ◇ 300,600,1200,1800,2400,4800,9600,19200,38400,57600,115200,230400,380400,460800,921600
    - ◆ data\_bits:
      - ◇ 8
    - ◆ stop\_bits:
      - ◇ 1,2
    - ◆ parity:
      - ◇ NONE
      - ◇ EVEN
      - ◇ ODD
    - ◆ Flowctrl: (CTSRTS)
      - ◇ NFC: No hardware flow control
      - ◇ FC: hardware flow control

4.2.2.18. AT+UARTF

- Function: Open/Close UART auto-frame function;
  - Format:
    - ◆ Query Operation
- AT+UARTF<CR>**  
**+ok=<para><CR><LF><CR><LF>**
- ◆ Set Operation
- AT+UARTF=<para ><CR>**  
**+ok<CR><LF><CR><LF>**
- Parameters:
    - ◆ para:
      - ◇ disable - Close auto-frame function;

- ◇ enable - Open auto-frame function;

#### 4.2.2.19. AT+UARTFT

- Function: Set/Query UART auto-frame trigger time;

- Format:

- ◆ Query Operation

**AT+UARTFT<CR>**

**+ok=<time><CR><LF><CR><LF>**

- ◆ Set Operation

**AT+UARTFT=<time ><CR>**

**+ok<CR><LF><CR><LF>**

- Parameters:

- ◆ time: Range 100 ~10000; Unit: ms. Auto-frame trigger time

#### 4.2.2.20. AT+UARTFL

- Function: Set/Query UART auto-frame trigger length;

- Format:

- ◆ Query Operation

**AT+UARTFL<CR>**

**+ok=<len><CR><LF><CR><LF>**

- ◆ Set Operation

**AT+UARTFL=<len ><CR>**

**+ok<CR><LF><CR><LF>**

- Parameters:

- ◆ len: Range 8 ~1000; Unit: Byte. Auto-frame trigger length;

#### 4.2.2.21. AT+UARTTE

- Function: Set/Query UART free-frame trigger time between two bytes;

- Format:

- ◆ Query Operation

**AT+UARTTE<CR>**

**+ok=<mode><CR><LF><CR><LF>**

- ◆ Set Operation

**AT+UARTTE=<mode><CR>**

**+ok<CR><LF><CR><LF>**

- Parameters:

- ◆ mode:

- ◇ fast: free-frame trigger time between two bytes is 10ms;

- ◇ normal: free-frame trigger time between two bytes is 50ms;

#### 4.2.2.22. AT+SEND

- Function: Send Data to SOCKA at Command Mode.

- Format:

**AT+SEND=<data\_lenth><CR>**

**+ok<CR><LF><CR><LF>**

- Parameters:
  - ◆ data\_lenth: Lenth of send data. Range: 0~1000 Byte

The UART port will wait 3 seconds for input after this command is sent OK. The data received from UART port is sent to SOCKA. If the interval of two bytes is more than 10ms, the data will be sent instantly.

#### 4.2.2.23. AT+RECV

- Function: Receive Data from SOCKA at Command Mode.
- Format:
  - AT+RECV=<data\_lenth><CR>**
  - +ok=< data\_lenth, data\_content><CR><LF><CR><LF>**
- Parameters:
  - ◆ data\_lenth: Lenth of receive data. Range: 0~1000 Byte
  - ◆ data\_content: contents of receive data.

If not receive any data in 3 second, then feedback +ok=0.

#### 4.2.2.24. AT+PING

- Function: Network “PING” Instruction.
- Format:
  - ◆ Set Operation
  - AT+PING=<IP\_address ><CR>**
  - +ok=<sta><CR><LF><CR><LF>**
- Parameters:
  - ◆ sta: feedback result
    - ◇ Success
    - ◇ Timeout
    - ◇ Unknown host

#### 4.2.2.25. AT+NETP

- Function: Set/Query network protocol parameters, Setting is valid after reset.
- Format:
  - ◆ Query Operation
  - AT+NETP<CR>**
  - +ok=<protocol,CS,port,IP><CR><LF><CR><LF>**
  - ◆ Set Operation
  - AT+NETP=<protocol,CS,port,IP><CR>**
  - +ok<CR><LF><CR><LF>**
- Parameters:
  - ◆ protocol:
    - ◇ TCP
    - ◇ UDP
  - ◆ CS: Network mode:
    - ◇ SERVER
    - ◇ CLIENT

- ◆ Port: protocol port ID: Decimal digit and less than 65535
- ◆ IP: Server's IP address when module set as client

If set as UDP SERVER, the module will save the IP address and port of the latest UDP packet received. The data will be sent to the saved IP address and port. If the module hasn't saved any IP address and port when power up. The data will be sent to the IP address and port which is set by this command.

If set as UDP,CLIENT, the data will always be sent to the IP address and port set by this command.

#### 4.2.2.26. AT+MAXSK

- Function:Set/ Query TCP Client connection number.
- Format:

- ◆ Query Operation

**AT+MAXSK<CR>**

**+ok=<num><CR><LF><CR><LF>**

- ◆ Set Operation

**AT+MAXSK=<num><CR>**

**+ok<CR><LF><CR><LF>**

- Parameters:
  - ◆ num: TCP Client connection number. Range: 1~5. 5 is the default value it means when the module work in TCP server , it accepts max 5 TCP client connect to it.

#### 4.2.2.27. AT+TCPLK

- Function: Query if TCP link already build-up;
- Format:

**AT+TCPLK<CR>**

**+ok=<sta><CR><LF><CR><LF>**

- Parameters:
  - ◆ sta.: if module already setup TCP link;
    - ◇ on: TCP link setup;
    - ◇ off: TCP link not setup;

#### 4.2.2.28. AT+TCPTO

- Function: Set/Query TCP timeout; Setting is valid after reset.
- Format:

- ◆ Query Operation

**AT+TCPTO<CR>**

**+ok=<time><CR><LF><CR><LF>**

- ◆ Set Operation

**AT+TCPTO=<time ><CR>**

**+ok<CR><LF><CR><LF>**

- Parameters:
  - ◆ time: TCP timeout time.
    - ◇ <= 600, (600s);



- ✧  $\geq 0$ , (0 means no timeout);
- ✧ Default, 300s;

Module begin to count time when TCP channel don't receive any data, clecherar time counter when TCP channel receive any data. If the time counter reaches the TCPTO, the tcp channel will be break. If the module work in TCP Client, it will connect the TCP server instantly and when the module work in TCP Server, the TCP client device should make the connection itself.

#### 4.2.2.29. AT+TCPDIS

- Function: Open/Close TCP link;
- Format:

- ◆ Query Opera

**AT+TCPDIS<CR>**

**+ok=<sta><CR><LF><CR><LF>**

- ◆ Set Operation

**AT+TCPDIS =<on/off><CR>**

**+ok<CR><LF><CR><LF>**

- Parameters:

When query, sta.: Feedback if TCP Client can be link,

- ✧ On, TCP link close
- ✧ off, TCP link on

When setting, "off" means close TCP link. After finish this command, module disconnect TCP link and not connect again. "On" means open TCP link. After finish this command, module re-connect TCP server right away.

#### 4.2.2.30. AT+SOCKB

- Function: Set/Query SOCKB parameters. Setting is valid after reset.
- Format:

- ◆ Query Operation

**AT+SOCKB<CR>**

**+ok=<protocol,port,IP><CR><LF><CR><LF>**

- ◆ Set Operation

**AT+SOCKB=<protocol,port,IP><CR>**

**+ok<CR><LF><CR><LF>**

- Parameters:

- ◆ Protocol: Protocol type:
  - ✧ TCP: Only for TCP Client
  - ✧ UDP: UDP Client
  - ✧ UDPS: UDP Server
- ◆ Port: Protocol Port in decimal, less than 65535
- ◆ IP: Destination IP address, domain name is support

If set as UDP SERVER, the module will save the IP address and port of the latest UDP packet received. The data will be sent to the saved IP address and port. If the module hasn't

saved any IP address and port when power up. The data will be sent to the IP address and port which is set by this command.

If set as UDP,CLIENT, the data will always be sent to the IP address and port set by this command.

#### 4.2.2.31. AT+TCPDISB

- Function: Open/Close SOCKB connection

- Format:

- ◆ Query Operation

**AT+TCPDISB<CR>**

**+ok=<sta><CR><LF><CR><LF>**

- ◆ Set Operation

**AT+TCPDISB =<on/off><CR>**

**+ok<CR><LF><CR><LF>**

- Parameters:

When setting, “off” means close TCP link. After finish this command, module disconnect TCP link and not connect again. “On” means open TCP link. After finish this command, module re-connect TCP server right away.

#### 4.2.2.32. AT+TCPTOB

- Function: Set/Query Operation SOCKB timeout. Setting is valid after reset.

- Format:

- ◆ Query Operation

**AT+TCPTOB<CR>**

**+ok=<time><CR><LF><CR><LF>**

- ◆ Set Operation

**AT+TCPTOB=<time ><CR>**

**+ok<CR><LF><CR><LF>**

- Parameters

- ◆ Time: TCP timeout

- ◇ ≤ 600:600s
- ◇ ≥ 0:0 means no timeout
- ◇ Default:300s

The module will not connect SOCKB after TCP timeout. The module will make connection after another “TCPDISB” command.

#### 4.2.2.33. AT+TCPLKB

- Function:Query SOCKB connection status

- Format:

**AT+TCPLKB<CR>**

**+ok=<sta><CR><LF><CR><LF>**

- Parameters:

- ◆ sta.: SOCKB connection status
  - ◇ on: TCP connected

✧ off: TCP disconnected

#### 4.2.2.34. AT+UDPLCPT

- Function: Set/Query UDP local port of Socket A and Socket B..

- Format:

- ◆ Query Operation

**AT+UDPLCPT<CR>**

**+ok=<porta,portb><CR><LF><CR><LF>**

- ◆ Set Operation

**AT+UDPLCPT=<porta,portb><CR>**

**+ok<CR><LF><CR><LF>**

- Parameters

- ◆ porta: UDP local port of Socket A, 0: do not fix local UDP port.
- ◆ portb: UDP local port of Socket B, 0: do not fix local UDP port.

#### 4.2.2.35. AT+SNDB

- Function: Send datas to SOCKB at Command Mode

- Format:

**AT+SNDB=<data\_lenth ><CR>**

**+ok<CR><LF><CR><LF>**

- Parameters:

- ◆ data\_lenth: Lenth of send data. Range: 0~1000 Byte

The UART port will wait 3 seconds for input after this command is sent OK. The data received from UART port is sent to SOCKB. If the interval of two bytes is more than 10ms, the data will be sent instantly.

#### 4.2.2.36. AT+RCVB

- Function: Receive datas from SOCKB at Command Mode

- Format:

**AT+RCVB=<data\_lenth><CR>**

**+ok=< data\_lenth, data\_content><CR><LF><CR><LF>**

- Parameters:

- ◆ data\_lenth: Lenth of receive data. Range: 0~1000 Byte
- ◆ data\_content: contents of receive data.

If not receive any data in 3 second, then feedback +ok=0.

#### 4.2.2.37. AT+WSSSID

- Function: Set/Query Wi-Fi associated AP SSID parameters. Setting is valid after reset.

- Format:

- ◆ Query Operation

**AT+WSSSID<CR>**

**+ok=<ap's ssid><CR><LF><CR><LF>**

- ◆ Set Operation

**AT+WSSSID=<ap's ssid ><CR>**

**+ok<CR><LF><CR><LF>**

- Parameters:
  - ◆ ap's ssid: AP's SSID (Within 32 character);

#### 4.2.2.38. AT+WSKEY

- Function: Set/Query STA security parameters. Setting is valid after reset.
- Format:
  - ◆ Query Operation

**AT+WSKEY<CR>**

**+ok=<auth,encry,key><CR><LF><CR><LF>**

- ◆ Set Operation

**AT+WSKEY=< auth,encry,key><CR>**

**+ok<CR><LF><CR><LF>**

- Parameters:
  - ◆ auth: Authentication mode
    - ◇ OPEN
    - ◇ SHARED
    - ◇ WPAPSK
    - ◇ WPA2PSK
  - ◆ encry:Encryption algorithm
    - ◇ NONE: When "auth=OPEN", effective
    - ◇ WEP: When "auth=OPEN" or "SHARED", effective
    - ◇ TKIP: When "auth= WPAPSK" or "WPA2PSK", effective
    - ◇ AES: When "auth= WPAPSK" "WPA2PSK", effective
  - ◆ key: password, ASCII code, shall less than 64 bit and greater than 8bit

#### 4.2.2.39. AT+WANN

- Function: Set/Query STA network setting. Setting is valid after reset.
- Format:
  - ◆ Query Operation

**AT+WANN<CR>**

**+ok=<mode,address,mask,gateway><CR><LF><CR><LF>**

- ◆ Set Operation

**AT+WANN=< mode,address,mask,gateway ><CR>**

**+ok<CR><LF><CR><LF>**

- Parameters:
  - ◆ mode: STA's IP network setting
    - ◇ static: Static IP
    - ◇ DHCP: Dynamic IP
  - ◆ address: STA IP address;
  - ◆ mask: STA subnet mask;
  - ◆ gateway: STA gateway address;

#### 4.2.2.40. AT+WSMAC

- Function: Set/Query STA MAC address parameters. Setting is valid after reset.

- Format:
  - ◆ Query Operation
 

```
AT+WSMAC<CR>
```

```
+ok=<mac_address><CR><LF><CR><LF>
```
  - ◆ Set Operation
 

```
AT+WSMAC=<code,mac_address><CR>
```

```
+ok<CR><LF><CR><LF>
```
- Parameters:
  - ◆ code: security code
    - ◇ 8888 (default value)
  - ◆ Mac\_address: STA MAC address, such as ACCF23FF1234

#### 4.2.2.41. AT+WSLK

- Function: Query STA WiFi link status
- Format:
  - ◆ Query Operation
 

```
AT+WSLK<CR>
```

```
+ok=<ret><CR><LF><CR><LF>
```
- Parameters:
  - ◆ ret
    - ◇ "Disconnected", if no WiFi connection;
    - ◇ "AP' SSID (AP's MAC" ) , if WiFi connection available;

#### 4.2.2.42. AT+WSLQ

- Function: Query STA WiFi signal strength;
- Format:
  - ◆ Query Operation
 

```
AT+WSLQ<CR>
```

```
+ok=<ret><CR><LF><CR><LF>
```
- Parameters:
  - ◆ ret
    - ◇ "Disconnected", if no WiFi connection;
    - ◇ "AP's WiFi signal strength" , if WiFi connection available;

#### 4.2.2.43. AT+WSCAN

- Function: Scan AP;
- Format:
 

```
AT+WSCAN<CR>
```

```
+ok=<ap_site><CR><LF><CR><LF>
```
- Parameters:
  - ◆ ap\_site: AP searched;

#### 4.2.2.44. AT+WSDNS

- Function: Set/Query STA static DNS server address;
- Format:

- ◆ Query Operation

**AT+WSDNS<CR>**

**+ok=<address><CR><LF><CR><LF>**

- ◆ Set Operation

**AT+WSDNS =<address><CR>**

**+ok<CR><LF><CR><LF>**

- Parameters:

- ◆ address: STA's DNS server address; Effective right away.

#### 4.2.2.45. AT+LANN

- Function: Set/Query AP's network parameters. Setting is valid after reset.

- Format:

- ◆ Query Operation

**AT+LANN<CR>**

**+ok=<ipaddress,mask><CR><LF><CR><LF>**

- ◆ Set Operation

**AT+LANN=< ipaddress,mask><CR>**

**+ok<CR><LF><CR><LF>**

- Parameters:

- ◆ ipaddress: AP's IP address;
- ◆ mask: AP's net mask;

#### 4.2.2.46. AT+WAP

- Function: Set/Query AP Wi-Fi parameters. Setting is valid after reset.

- Format:

- ◆ Query Operation

**AT+WAP<CR>**

**+ok=<wifi\_mode,ssid,channel><CR><LF><CR><LF>**

- ◆ Set Operation

**AT+WAP =<wifi\_mode,ssid,channel><CR>**

**+ok<CR><LF><CR><LF>**

- Parameters:

- ◆ wifi\_mode: Wi-Fi mode, include:
  - ◇ 11B
  - ◇ 11BG
  - ◇ 11BGN (Default Value)
- ◆ ssid:SSID at AP mode
- ◆ channel: Wi-Fi channel selection:
  - ◇ AUTO
  - ◇ CH1~CH11; (Default CH1)

#### 4.2.2.47. AT+WKEY

- Function: Set/Query AP Wi-Fi security parameters. Setting is valid after reset.

- Format:

- ◆ Query Operation

**AT+WAKEY<CR>**

**+ok=<auth, encry, key><CR><LF><CR><LF>**

- ◆ Set Operation

**AT+WAKEY=< auth, encry, key><CR>**

**+ok<CR><LF><CR><LF>**

- Parameters:

- ◆ auth: include
  - ◇ OPEN
  - ◇ WPA2PSK
- ◆ Encry: include
  - ◇ NONE: When “auth=OPEN” available;
  - ◇ AES: When “auth=WPA2PSK” available;
- ◆ key: security code, ASCII code, smaller than 64bit and bigger than 8 bit;

#### 4.2.2.48. AT+WAMAC

- Function: Query AP MAC address parameters;
- Format:
  - ◆ Query Operation

**AT+WAMAC<CR>**

**+ok=<mac\_address><CR><LF><CR><LF>**

- Parameters:

- ◆ mac\_address: AP’s MAC address;

Note: Module AP mode’s MAC address is related to STA mode’s MAC address. If user need change to others, please contact with high-flying technical people.

#### 4.2.2.49. AT+WADHCP

- Function: Set/Query AP DHCP server status; Setting is valid after reset.
- Format:
  - ◆ Query Operation

**AT+WADHCP<CR>**

**+ok=<status><CR><LF><CR><LF>**

- ◆ Set Operation

**AT+WADHCP=<status><CR>**

**+ok<CR><LF><CR><LF>**

- Parameters:

- ◆ status: AP’s DHCP server function status:
  - ◇ on: DHCP Server Open;
  - ◇ off: DHCP Server Close;

#### 4.2.2.50. AT+WADMN

- Function: Set/Query AP webpage domain name;
- Format:
  - ◆ Query Operation

**AT+WADMN<CR>**

**+ok=<domain\_name><CR><LF><CR><LF>**

- ◆ Set Operation

**AT+WADMN=<domain\_name><CR>**

**+ok<CR><LF><CR><LF>**

- Parameters:
  - ◆ Domain\_name: Webpage domain name (within 20 characters, can't all numbers).

#### 4.2.2.51. AT+WALK

- Function: Query MAC address of STA device connecting to module AP
- Format:
  - ◆ Query Operation

**AT+WALK<CR>**

**+ok=<status> <CR><LF><CR><LF>**

- Parameters:
  - ◆ status: MAC address of STA device connecting to module AP.
    - ✧ No Connection: No STA device connecting to module AP;

#### 4.2.2.52. AT+WALKIND

- Function: Enable/Disable indication of module AP connection status.
- Format:
  - ◆ Query Operation

**AT+WALKIND<CR>**

**+ok=<status> <CR><LF><CR><LF>**

- ◆ Set Operation

**AT+WALKIND=<status><CR>**

**+ok<CR><LF><CR><LF>**

- Parameters:
  - ◆ status: indication of module AP connection status.
    - ✧ on: Enable nLink indication function. When STA device connecting to module AP, nLink output Low, otherwise output High.
    - ✧ off: Disable nLink indication function. **(default mode)**.

#### 4.2.2.53. AT+PLANG

- Function: Set/Query webpage language option;
- Format:
  - ◆ Query Operation

**AT+PLANG<CR>**

**+ok=<language> <CR><LF><CR><LF>**

- ◆ Set Operation

**AT+PLANG=<language> <CR>**

**+ok<CR><LF><CR><LF>**

- Parameters:
  - ◆ language: webpage's language



- ✧ CN: Chinese Version (Default);
- ✧ EN: English Version;

#### 4.2.2.54. AT+UPURL

- Function: Set/ Query remote upgrade URL address;
- Format:

- ◆ Query Operation

**AT+UPURL<CR>**

**+ok=<url> <CR><LF><CR><LF>**

- ◆ Set Operation

**AT+UPURL=<url,filename> <CR>**

**+ok<CR><LF><CR><LF>**

- Parameters:
  - ◆ url: the upgrade file url address; the last charater shall be "/" (within 20 characters).
  - ◆ filename: the upgrade file name, it's optional and not saved parameter. If provide this file name here, the module will start upgrade right away;

#### 4.2.2.55. AT+UPFILE

- Function: Set/ Query remote upgrade configure file name;
- Format:

- ◆ Query Operation

**AT+UPFILE<CR>**

**+ok=<filename> <CR><LF><CR><LF>**

- ◆ Set Operation

**AT+UPFILE=<filename> <CR>**

**+ok<CR><LF><CR><LF>**

- Parameters:
  - ◆ filename: the upgrade configure file name (within 20 characters).

#### 4.2.2.56. AT+LOGSW

- Function: Open/Close remote upgrade logfile
- Format:

- ◆ Query Operation

**AT+LOGSW<CR>**

**+ok=<status><CR><LF><CR><LF>**

- ◆ Set Operation

**AT+LOGSW=<status><CR>**

**+ok<CR><LF><CR><LF>**

- Parameters:
  - ◆ status:
    - ✧ on: Open. The UART Port will print some upgrade status when upgrading. the log file will be sent to UDP Port after successfully
    - ✧ off: Close.

## 4.2.2.57. AT+LOGPORT

- Function: Set/Query remote upgrade UDP port of log file.
- Format:

- ◆ Query Operation

**AT+LOGPORT<CR>**

**+ok=<port><CR><LF><CR><LF>**

- ◆ Set Operation:

**AT+LOGPORT =<port><CR>**

**+ok<CR><LF><CR><LF>**

- Parameters:

- ✧ port: The remote upgrade UDP port of log file.

## 4.2.2.58. AT+UPST

- Function: Start remote upgrade;
- Format:
- ◆ Query Operation

**AT+UPST<CR>**

**+ok=<log> <CR><LF><CR><LF>**

- Parameters:

- ◆ log: feedback the status of remote upgrade;

**Note:** After execute this command, the HF-LPB100 will automatic start upgrade base on the setting of UPURL, UPFILE command contents;

## 4.2.2.59. AT+WEBU

- Function: Set/ Query webpage user name and password; Setting is valid after reset.
- Format:
- ◆ Query Operation

**AT+WEBU<CR>**

**+ok=<username,password> <CR><LF><CR><LF>**

- ◆ Set Operation

**AT+WEBU=<username,password><CR>**

**+ok<CR><LF><CR><LF>**

- Parameters:

- ◆ username: User Name, within 15 characters, not support empty.
- ◆ password: password, within 15 characters, support empty.

## 4.2.2.60. AT+MSLP

- Function: Set/Query deep sleep/standby mode parameters;
- Format:
- ◆ Query Operation

**AT+MSLP<CR>**

**+ok=<ret><CR><LF><CR><LF>**

- ◆ Set Operation

**AT+MSLP=<mode><CR><LF><CR><LF>**

- Parameters:
  - ◆ ret:
    - ◇ normal: normal mode (100ms interval)
  - ◆ mode:
    - ◇ normal: normal mode (100ms interval)
    - ◇ standby: WiFi shut down mode.(Reserved)

#### 4.2.2.61. AT+NTPRF

- Function: Set /Query time calibration interval
- Format:
  - ◆ Query Operation
 

```
AT+NTPRF<CR>
+ok=<num><CR><LF><CR><LF>
```
  - ◆ Set Operation
 

```
AT+NTPRF=<num><CR>
+ok<CR><LF><CR><LF>
```
- Parameters:
  - ◆ num: time calibration interval, range:0~720, default:30 minutes, 10 minutes for each step, set 0 means no time calibration automatically.

#### 4.2.2.62. AT+NTPEN

- Function: Enable/Disable time calibration function. Setting is valid after reset.
- Format:
  - ◆ Query Operation
 

```
AT+NTPEN<CR>
+ok=<status><CR><LF><CR><LF>
```
  - ◆ Set Operation
 

```
AT+NTPEN=<status><CR>
+ok<CR><LF><CR><LF>
```
- Parameters:
  - ◆ status: status of time calibration
    - on: Enable time calibration
    - off: Disable time calibration

#### 4.2.2.63. AT+NTPTM

- Function: Query network time
- Format:
  - ◆ Query Operation
 

```
AT+NTPTM<CR>
+ok=<time><CR><LF><CR><LF>
```
- Parameters:
  - ◆ time: network time, for example: 2013-10-9 16:10:42 Wed, if it shows Not Available means that the time calibration function is not enabled or the module doesn't connect to the internet.

## 4.2.2.64. AT+NTPSER

- Function: Set/Query NTP server IP address..
- Format:
  - ◆ Query Operation
  - AT+NTPSER<CR>**
  - +ok=<ipaddress><CR><LF><CR><LF>**
  - ◆ Set Operation
  - AT+NTPSER=<ipaddress><CR>**
  - +ok<CR><LF><CR><LF>**
- Parameters:
  - ◆ ipaddress: NTP network server IP address, 61.164.36.105(default value).

## 4.2.2.65. AT+WRMID

- Function: Set module ID;
- Format:
  - ◆ Set Operation
  - AT+WRMID=<wrmid> <CR><LF><CR><LF>**
- Parameters:
  - ◆ wrmid: set module's ID (within 20 characters).

## 4.2.2.66. AT+RLDEN

- Function: Set/Query nReload Pin function status
- Format:
  - ◆ Query Operation
  - AT+RLDEN<CR>**
  - +ok=<status><CR><LF><CR><LF>**
  - ◆ Set Operation
  - AT+RLDEN=<status><CR>**
  - +ok<CR><LF><CR><LF>**
- Parameters:
  - ◆ status: The status of module's nReload pin function
    - ◇ on: nReload pin function is enabled.
    - ◇ off: nReload pin function is disabled

## 4.2.2.67. AT+ASWD

- Function: Set/Query WiFi Configuration Password;
- Format:
  - ◆ Query Operation
  - AT+ASWD<CR>**
  - +ok=<aswd> <CR><LF><CR><LF>**
  - ◆ Set Operation
  - AT+ASWD=<aswd> <CR><LF><CR><LF>**
- Parameters:
  - ◆ aswd: WiFi Configuration Password (within 20 characters).

## 4.2.2.68. AT+MDCH

- Function: Set Wi-Fi Auto Switch Function. Setting is valid after reset.
- Format:
  - ◆ Query Operation
 

```
AT+MDCH<CR>
```

```
+ok=<mode> <CR><LF><CR><LF>
```
  - ◆ Set Operation
 

```
AT+MDCH=<mode> <CR><LF><CR><LF>
```
- Parameters:
  - ◆ mode: Wi-Fi Auto Switch Mode
    - ◇ off: Disable Wi-Fi auto switch.
    - ◇ on: Enable Wi-Fi auto switch. When the module(STA mode) fail to connect to router, it will switch to AP mode itself in one minute.
    - ◇ auto: Enable Wi-Fi auto detect function. The module will reset itself when encounter any abnormal. The default time interval is 10 minutes. **(default mode)**
    - ◇ 3-120: unit: minute. Set the time interval to reset itself when abnormal.

## 4.2.2.69. AT+TXPWR

- Function: Set/Query Wi-Fi Transmit Power, Real Transmit Power=Default Transmit Power(16dBm) – [Setting Value] \* 0.5dBm. Setting is valid after reset.
- Format:
  - ◆ Query Operation
 

```
AT+TXPWR <CR>
```

```
+ok=<num><CR><LF><CR><LF>
```
  - ◆ Set Operation
 

```
AT+TXPWR=<num><CR>
```

```
+ok<CR><LF><CR><LF>
```
- Parameters:
  - ◆ num: [Setting Value]. The default is 0, it can be sent from 0 ~ 24. If set to 24, the module transmit power will be at a minimum of 4dBm. Reboot to make this setting change valid. It will not restore to default if reload the module.

## 4.2.2.70. AT+SMTLK

- Function: Start WPS function
- Format:
  - ◆ Query Operation
 

```
AT+SMTLK<CR>
```

SmartLink is a One-Key config function. Config the module connecting to router easily. After start SmartLink function, the module work in SmartLink status and nLink LED is fast flashing waiting for APP to push information. See the Appendix for more details.

## 4.2.2.71. AT+WPS

- Function: Start WPS function

- Format:
  - ◆ Query Operation
 

```
AT+WPS<CR>
```

```
+ok=<status> <CR><LF><CR><LF>
```
- Parameters:
  - ◆ status: Start WPS Scan function. The module will reboot and work in STA mode connecting to specific router when WPS communication is OK.
    - ✧ WPS Scan Failed: WPS communication is failed.

Note: The router WPS function must be open first then enable module WPS Scan function. The module will quit WPS scan status if there is no WPS router in 5 seconds.

#### 4.2.2.72. AT+WPSBTNEN

- Function: Enable/Disable WPS function.
- Format:
  - ◆ Query Operation
 

```
AT+WPSBTNEN<CR>
```

```
+ok=<status> <CR><LF><CR><LF>
```
  - ◆ Set Operation
 

```
AT+ WPSBTNEN =<status><CR>
```

```
+ok<CR><LF><CR><LF>
```
- Parameters:
  - ◆ status:
    - ✧ on: Enable WPS function
    - ✧ off: Disable WPS function.

Note: The router WPS function must be open first then enable module WPS Scan function. The module will quit WPS scan status if there is no WPS router in 5 seconds.

#### 4.2.2.73. AT+LPTIO

- Function: nReady,nLink, WPS function mapping. Setting is valid after reset.
- Format:
  - ◆ Query Operation
 

```
AT+LPTIO<CR>
```

```
+ok=<status> <CR><LF><CR><LF>
```
  - ◆ Set Operation
 

```
AT+ LPTIO =<status><CR>
```

```
+ok<CR><LF><CR><LF>
```
- Parameters:
  - ◆ status: nReady,nLink, WPS function mapping.
    - ✧ off/lpb100: nReady,nLink, WPS function are mapping to HF-LPB100 corresponding pin.(Pin44, Pin43, Pin15)
    - ✧ on/lpt100: nReady,nLink, WPS function are mapping to HF-LPT100 corresponding pin.(Pin9, Pin10, Pin8)
    - ✧ lpt200: nReady,nLink, WPS function are mapping to HF-LPT200 corresponding pin.(Pin11, Pin13, Pin14)

## 5. PACKAGE INFORMATION

### 5.1. Recommended Reflow Profile

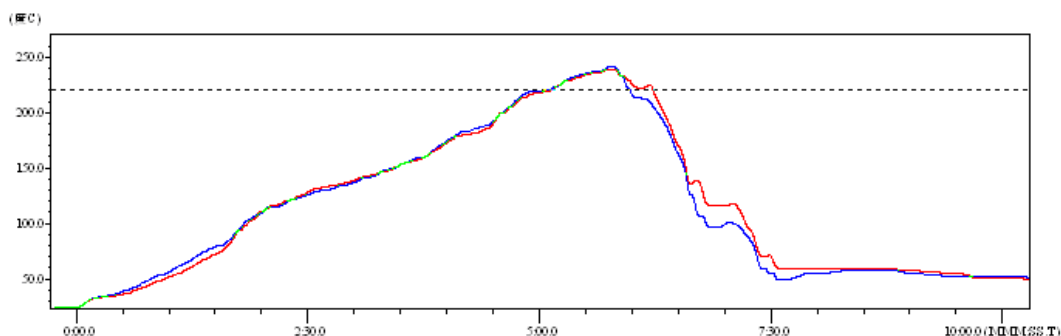

Figure 27. Reflow Soldering Profile

Table 11 Reflow Soldering Parameter

| NO. | Item        | Temperature (Degree) | Time(Sec) |
|-----|-------------|----------------------|-----------|
| 1   | Reflow Time | Time of above 220    | 35~55 sec |
| 2   | Peak-Temp   | 260 max              |           |

- Note:** 1. Recommend to supply N2 for reflow oven.  
 2. N2 atmosphere during reflow (O2<300ppm)

### 5.2. Device Handling Instruction (Module IC SMT Preparation)

- Shelf life in sealed bag: 12 months, at <30°C and <60% relative humidity (RH)
- After bag is opened, devices that will be re-baked required after last baked with window time 168 hours.
- Recommend to oven bake with N2 supplied
- Recommend end to reflow oven with N2 supplied
- Baked required with 24 hours at 125±5°C before rework process for two modules, one is new module and two is board with module
- Recommend to store at ≤ 10% RH with vacuum packing
- If SMT process needs twice reflow:
  - Top side SMT and reflow
  - Bottom side SMT and reflow

Case 1: Wifi module mounted on top side. Need to bake when bottom side process over 168 hours window time, no need to bake within 168 hours

Case 2: Wifi module mounted on bottom side, follow normal bake rule before process

**Note:** Window time means from last bake end to next reflow start that has 168 hours space.

### 5.3. Shipping Information

#### TAPE

Size: 340\*340\*70 mm



#### BOX

Size: 340\*340\*350 mm (inside)



Figure 28. Shipping Information

**Note:**

1 tape = 500pcs

1 box = 5 tapes = 5 \* 500 pcs = 2500pcs



# APPENDIX A: HW REFERENCE DESIGN

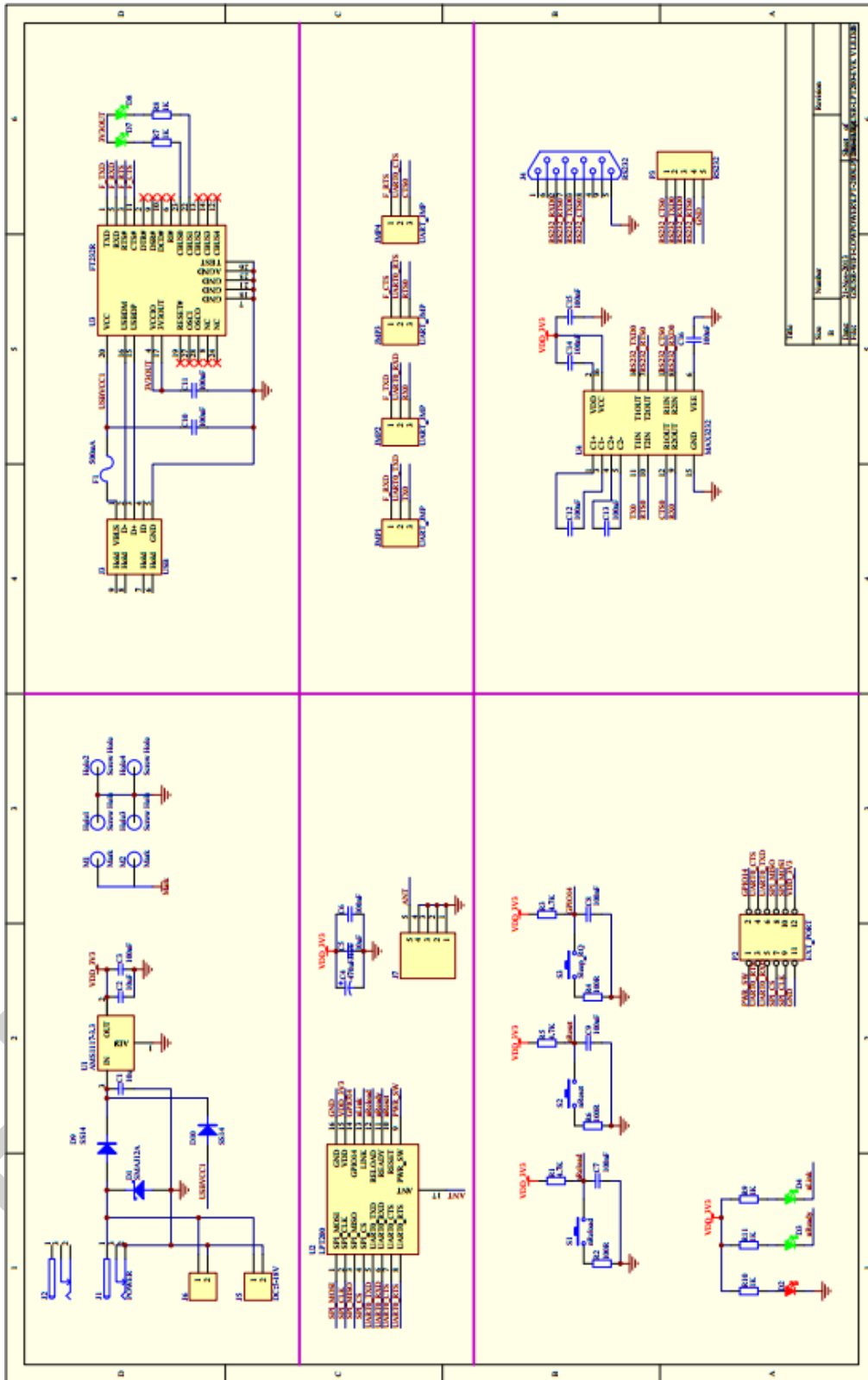

Detailed HF-LPT200 Evaluation Board design source files, pls access High-Flying web download page or contact with High-Flying technical support people to acquire.

## APPENDIX B: HTTP PROTOCOL TRANSFER

HF-LPT200 module support http data transfer in command mode. If any detailed HTTP protocol, contact us and we may support customization.

### B.1. HTTP AT command

#### B.1.1. AT+HTTPURL

- Function: Set /Query HTTP server IP address and Port Number.
- Format:
  - ◆ Query Operation
 

```
AT+HTTPURL<CR>
+ok=<IP,Port><CR><LF><CR><LF>
```
  - ◆ Set Operation
 

```
AT+HTTPURL=<IP,Port><CR>
+ok<CR><LF><CR><LF>
```
- Parameters:
  - ◆ IP: IP address.
  - ◆ Port: Port number.

#### B.1.2. AT+HTTPTP

- Function: Set /Query HTTP request type
- Format:
  - ◆ Query Operation
 

```
AT+HTTPTP<CR>
+ok=<Type><CR><LF><CR><LF>
```
  - ◆ Set Operation
 

```
AT+HTTPTP=<Type><CR>
+ok<CR><LF><CR><LF>
```
- Parameters:
  - ◆ Type: GET(default) or POST.

#### B.1.3. AT+HTTTPH

- Function: Set/Query HTTP protocol header path.
- Format:
  - ◆ Query Operation
 

```
AT+HTTTPH<CR>
+ok=<Path><CR><LF><CR><LF>
```
  - ◆ Set Operation
 

```
AT+HTTTPH=<Path><CR>
+ok<CR><LF><CR><LF>
```
- Parameters:

- ◆ Path: Max length is 50 bytes.

#### B.1.4. AT+HTTPCN

- Function: Set/Query Connection of HTTP protocol header

- Format:

- ◆ Query Operation

**AT+HTTPCN<CR>**

**+ok=<Connection><CR><LF><CR><LF>**

- ◆ Set Operation

**AT+HTTPCN=<Connection><CR>**

**+ok<CR><LF><CR><LF>**

- Parameters:

- ◆ Connection: Max length is 20 bytes.

#### B.1.5. AT+HTTPUA

- Function: Set/Query User-Agent of HTTP protocol header.

- Format:

- ◆ Query Operation

**AT+HTTPUA<CR>**

**+ok=<Parameter><CR><LF><CR><LF>**

- ◆ Set Operation

**AT+HTTPUA=<Parameter><CR>**

**+ok<CR><LF><CR><LF>**

- Parameters:

- ◆ Parameter: Max length is 20 bytes.

#### B.1.6. AT+HTTPDPT

- Function: Send HTTP request or data.

- Format:

- ◆ Set Operation

**AT+HTTPDPT=<Data><CR>**

**+ok<CR><LF><CR><LF>**

- Parameters:

- ◆ Data: HTTP request data, send AT+HTTPDPT directly if no data to be sent.

## B.2. HTTP Example

HTTP parameter settings are as follows:

|                           |                                  |
|---------------------------|----------------------------------|
| AT+HTTPURL=192.168.1.1,80 | Set HTTP server address and port |
| AT+HTTPPT=POST            | Set HTTP request type            |
| AT+HTTPPH=/abcd           | Set HTTP protocol header path    |
| AT+HTTPCN= keep-alive     | Set HTTP Connection area         |
| AT+HTTPUA= lwip1.3.2      | Set HTTP User-Agent area         |

If send “AT+HTTPD”, the data packet will be sent as the following instance including the two new line:

```
POST /abcd HTTP/1.1
Connection:keep-alive
User-Agent:lwip1.3.2
Content-Length:0
Host:192.168.0.127:8999
```

If send AT+HTTPD=abcd, the data packet will be sent as the following instance:

```
POST /abcd HTTP/1.1
Connection:keep-alive
User-Agent:lwip1.3.2
Content-Length:4
Host:192.168.0.127:8999
```

abcd

The data received from HTTP server will be output to serial port and end with “+ok”.

If the module hasn't received data from HTTP server for 5 second, it will cut the TCP link with HTTP server.

## APPENDIX C: REFERENCES

### C.1. High-Flying Mass Production Tool

Download Address: [http://www.hi-flying.com/download\\_detail\\_dc/&downloadsId=07bc0a59-0a0d-4fb4-a5e5-c3403f09ab08&comp\\_stats=comp-FrontDownloads\\_list01-dc.html](http://www.hi-flying.com/download_detail_dc/&downloadsId=07bc0a59-0a0d-4fb4-a5e5-c3403f09ab08&comp_stats=comp-FrontDownloads_list01-dc.html)

### C.2. SmartLink APP Config Tool

IOS Platform : [http://www.hi-flying.com/download\\_detail\\_dc/&downloadsId=5cc0c241-77b4-48c1-bf9c-2ad2954b3b50&comp\\_stats=comp-FrontDownloads\\_list01-dc.html](http://www.hi-flying.com/download_detail_dc/&downloadsId=5cc0c241-77b4-48c1-bf9c-2ad2954b3b50&comp_stats=comp-FrontDownloads_list01-dc.html)

Android Platform: [http://www.hi-flying.com/download\\_detail\\_dc/&downloadsId=9a0d0290-477e-4184-8636-18510eaed6b1&comp\\_stats=comp-FrontDownloads\\_list01-dc.html](http://www.hi-flying.com/download_detail_dc/&downloadsId=9a0d0290-477e-4184-8636-18510eaed6b1&comp_stats=comp-FrontDownloads_list01-dc.html)

### C.3. EVK Quick Start Guide

Download Address: [http://www.hi-flying.com/download\\_detail\\_dc/&downloadsId=b545c662-4ec7-49a4-aea4-e0997f062a62&comp\\_stats=comp-FrontDownloads\\_list01-dc.html](http://www.hi-flying.com/download_detail_dc/&downloadsId=b545c662-4ec7-49a4-aea4-e0997f062a62&comp_stats=comp-FrontDownloads_list01-dc.html)

## APPENDIX D: CONTACT INFORMATION

---

**Address:** Room.511/510, Building 7, No.365, Chuanhong Road, Pudong New Area,  
Shanghai, China, 201202

**Web:** [www.hi-flying.com](http://www.hi-flying.com)

**Service Online:** 400-189-3108

**Sales Contact:** [sales@hi-flying.com](mailto:sales@hi-flying.com)

---

For more information about High-Flying modules, applications, and solutions, please visit our web site  
<http://www.hi-flying.com/en/>

**<END OF DOCUMENT>**

---

© Copyright High-Flying, May, 2011

The information disclosed herein is proprietary to High-Flying and is not to be used by or disclosed to unauthorized persons without the written consent of High-Flying. The recipient of this document shall respect the security status of the information.

The master of this document is stored on an electronic database and is "write-protected" and may be altered only by authorized persons at High-Flying. Viewing of the master document electronically on electronic database ensures access to the current issue. Any other copies must be regarded as uncontrolled copies.