

Description

The AZ2185 series is low dropout positive voltage regulators with a maximum dropout of 1.5V at 3A of load current.

The device features low quiescent current, low adjustable current and improved load transient performance. This device built in band-gap reference circuit, on-chip thermal shutdown and current limit function.

The AZ2185 is available in adjustable version. The adjustable version can set the output voltage with two external resistors.

The AZ2185 series is available in standard packages of TO252 (Standard).

Features

- Low Dropout Voltage: Typical 1.3V at 3A
- Current Limiting and Thermal Protection
- Output Current: 3A
- Current Limit: 4.5A
- Operating Junction Temperature: -40 to +125°C
- Line Regulation: 0.015%/V (Typ)
- Load Regulation: 0.1%/A (Typ)
- Adjust Pin Current: 6µA (Typ)
- Minimum Load Current: 0.3mA (Typ)
- Compatible with Low ESR Ceramic Capacitor
- **Totally Lead-Free & Fully RoHS Compliant (Notes 1 & 2)**
- **Halogen and Antimony Free. "Green" Device (Note 3)**

Applications

- High Efficiency Linear Regulators
- Battery Charger
- Digital Video/Camcorder
- Post Regulation for Switching Supplies
- Microprocessor Supply
- Mother Board Power Supplies
- DVD-video Player
- Telecom Equipment
- Set Top Boxes and Web Boxes Modules' Supply

Features

(Top View)

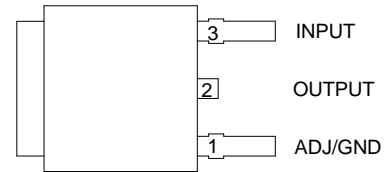

TO252 (Standard)

Applications

- High Efficiency Linear Regulators
- Battery Charger
- Digital Video/Camcorder
- Post Regulation for Switching Supplies
- Microprocessor Supply
- Mother Board Power Supplies
- DVD-video Player
- Telecom Equipment
- Set Top Boxes and Web Boxes Modules' Supply

- Notes:
1. No purposely added lead. Fully EU Directive 2002/95/EC (RoHS) & 2011/65/EU (RoHS 2) compliant.
 2. See http://www.diodes.com/quality/lead_free.html for more information about Diodes Incorporated's definitions of Halogen- and Antimony-free, "Green" and Lead-free.
 3. Halogen- and Antimony-free "Green" products are defined as those which contain <900ppm bromine, <900ppm chlorine (<1500ppm total Br + Cl) and <1000ppm antimony compounds.

Typical Applications Circuit (Note 4)

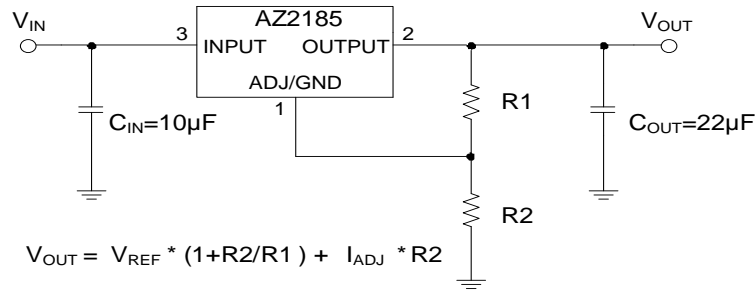

Note 4: The AZ2185 is compatible with low ESR ceramic capacitor.
The ESR of the output capacitors must be less than 0.4Ω.
A minimum of 10µF output capacitor is required.

Pin Descriptions

| Pin Number | Pin Name | Function |
|------------|----------|-------------------|
| 1 | ADJ/GND | Adjust pin/Ground |
| 2 | OUTPUT | Output voltage |
| 3 | INPUT | Input voltage |

Functional Block Diagram

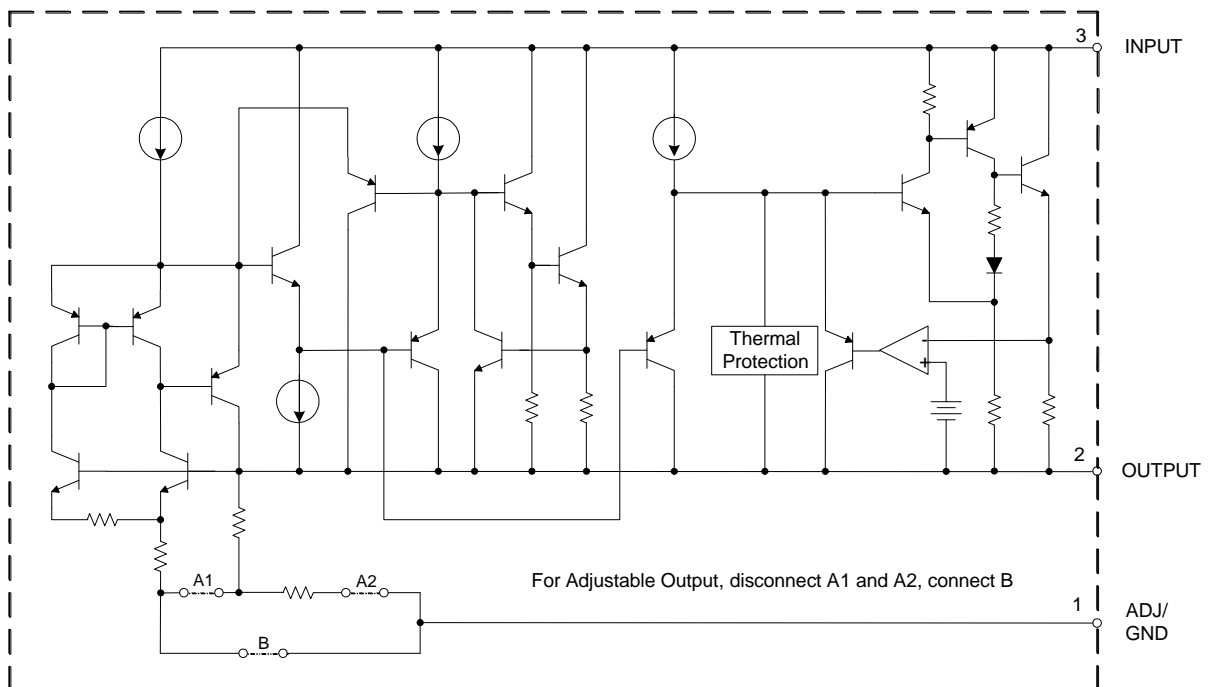

Absolute Maximum Ratings (Note 5)

| Symbol | Parameter | Rating | Unit |
|---------------|--|-------------|------|
| V_{IN} | Input Voltage | 18 | V |
| T_J | Operating Junction Temperature | +150 | °C |
| T_{STG} | Storage Temperature Range | -65 to +150 | °C |
| T_{LEAD} | Lead Temperature (Soldering, 10sec) | +260 | °C |
| θ_{JA} | Thermal Resistance (Junction to Ambient) | 75 | °C/W |
| — | ESD (Human Body Model) | 5000 | V |
| — | ESD (Charge Device Model) | 2000 | V |

Note 5: Stresses greater than those listed under “Absolute Maximum Ratings” may cause permanent damage to the device. These are stress ratings only, and functional operation of the device at these or any other conditions beyond those indicated under “Recommended Operating Conditions” is not implied. Exposure to “Absolute Maximum Ratings” for extended periods may affect device reliability.

Recommended Operating Conditions

| Symbol | Parameter | Min | Max | Unit |
|----------|--------------------------------|-----|------|------|
| V_{IN} | Input Voltage | — | 12 | V |
| T_J | Operating Junction Temperature | -40 | +125 | °C |

Electrical Characteristics (Typicals and limits appearing in normal type apply for $T_J = +25^\circ\text{C}$. Limits appearing in **Boldface** type apply over the entire operating junction temperature range -40 to $+125^\circ\text{C}$.)

| Symbol | Parameter | Conditions | Min | Typ | Max | Unit |
|----------------------|--|---|-----------------------|-----------------------|-----------------------|--------------------|
| V_{REF} | Reference Voltage | $I_{OUT} = 10\text{mA}$, $V_{IN}-V_{OUT} = 3\text{V}$, $T_J = +25^\circ\text{C}$, $10\text{mA} \leq I_{OUT} \leq 3\text{A}$, $1.5\text{V} \leq V_{IN}-V_{OUT} \leq 5\text{V}$ | 1.238 1.225 | 1.250 1.250 | 1.262 1.275 | V |
| V_{RLOAD} | Load Regulation | $10\text{mA} \leq I_{OUT} \leq 3\text{A}$, $V_{IN}-V_{OUT} = 3\text{V}$ | — | 0.1 0.2 | 0.4 0.5 | %/A |
| V_{RLINE} | Line Regulation | $I_{OUT} = 10\text{mA}$, $2.85\text{V} \leq V_{IN} \leq 10\text{V}$ | — | 0.015 0.035 | 0.2 0.2 | %/V |
| V_{DROP} | Dropout Voltage | $I_{OUT} = 3\text{A}$, ΔV_{REF} , $\Delta V_{OUT} = 1\%$ | — | 1.3 | 1.5 | V |
| I_{LIMIT} (Note 6) | Current Limit | $V_{IN}-V_{OUT} = 3\text{V}$ | 3.2 | 4.5 | 4.95 | A |
| I_{LOAD} | Minimum Load Current | $V_{IN} = 10\text{V}$ | — | 0.3 | 1 | mA |
| I_{ADJ} | Adjust Pin Current | $V_{IN} = 4.25\text{V}$, $I_{OUT} = 10\text{mA}$ | — | 6 | 10 | μA |
| ΔI_{ADJ} | Adjust Pin Current Change | $10\text{mA} \leq I_{OUT} \leq 3\text{A}$, $1.5\text{V} \leq V_{IN}-V_{OUT} \leq 6\text{V}$ | — | 0.3 | 2 | μA |
| PSRR | Ripple Rejection | $f_{RIPPLE} = 120\text{Hz}$, $C_{OUT} = 22\mu\text{F}$, $I_{OUT} = 3\text{A}$, $V_{IN}-V_{OUT} = 3\text{V}$ | — | 50 | — | dB |
| — | Long Term Stability | $T_A = +125^\circ\text{C}$, 1000Hrs | — | 0.5 | — | % |
| — | Temperature Stability | $I_{OUT} = 10\text{mA}$, $V_{IN}-V_{OUT} = 1.5\text{V}$ | — | 50 | — | PPM% |
| — | RMS Noise (% of V_{OUT}) | $T_A = +125^\circ\text{C}$, $10\text{Hz} \leq f \leq 10\text{kHz}$ | — | 0.003 | — | % |
| — | OTSD | — | — | +150 | — | $^\circ\text{C}$ |
| — | OTSD Hysteresis | — | — | +20 | — | $^\circ\text{C}$ |
| θ_{JC} | Thermal Resistance (Junction to Case) | — | — | 10 | — | $^\circ\text{C/W}$ |

Note 6: Make the V_{OUT} down to about 98% of the test values, I_{OUT} value is set to I_{LIMIT} at this time.

Performance Characteristics

NEW PRODUCT

Line Regulation vs. Temperature

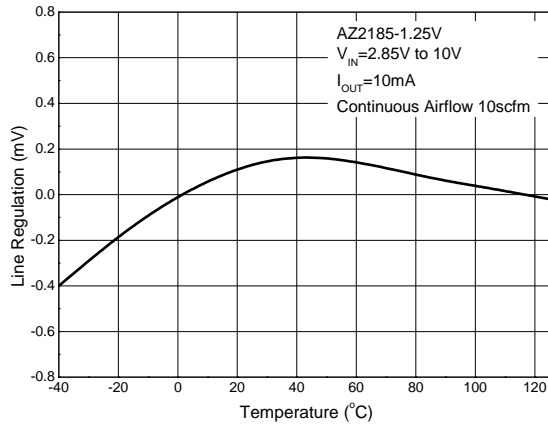

Load Regulation vs. Temperature

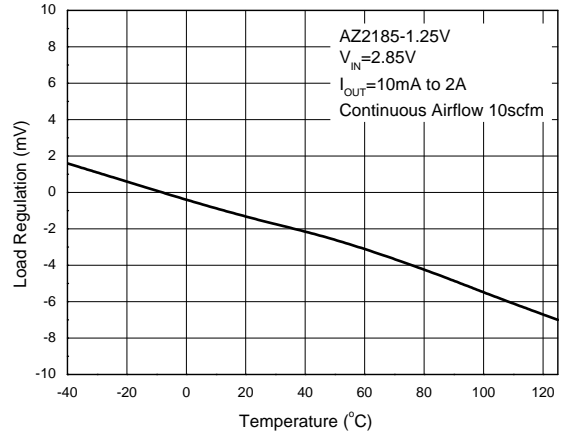

Reference Voltage vs. Temperature

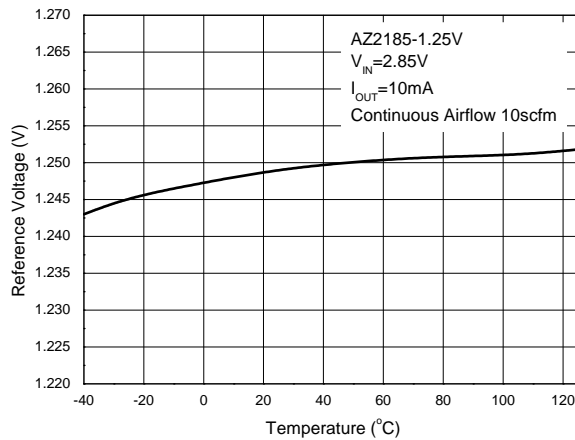

Current Limit vs. Temperature

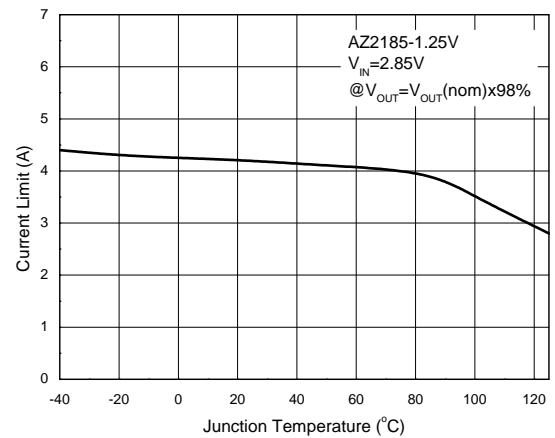

Minimum Load Current vs. Temperature

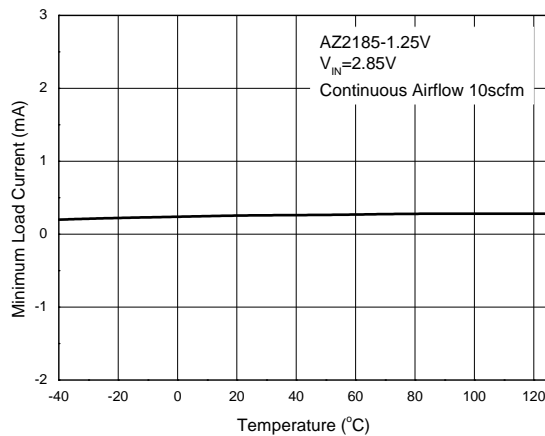

Adjust Pin Current vs. Temperature

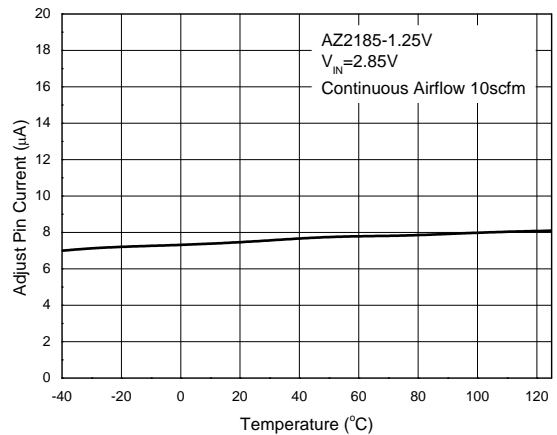

Performance Characteristics (Cont.)

Dropout Voltage vs. Output Current

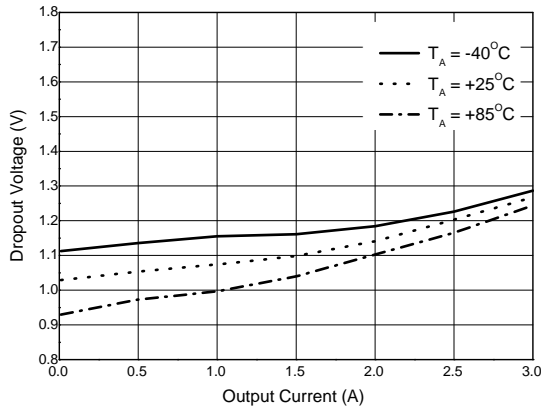

Dropout Voltage vs. Temperature

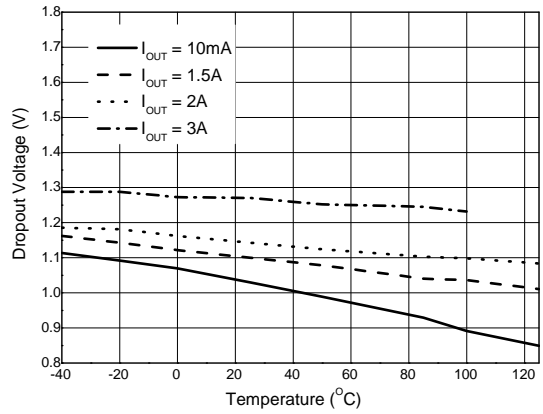

PSRR vs. Frequency

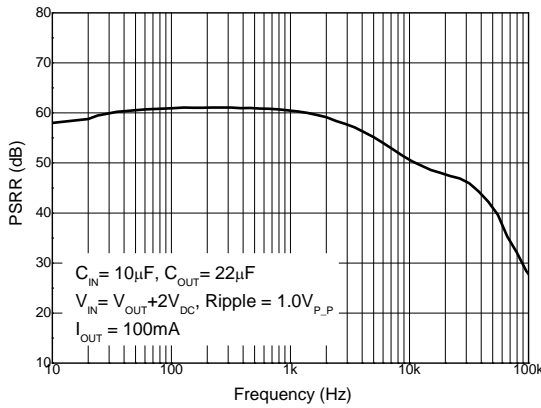

Load Transient Response

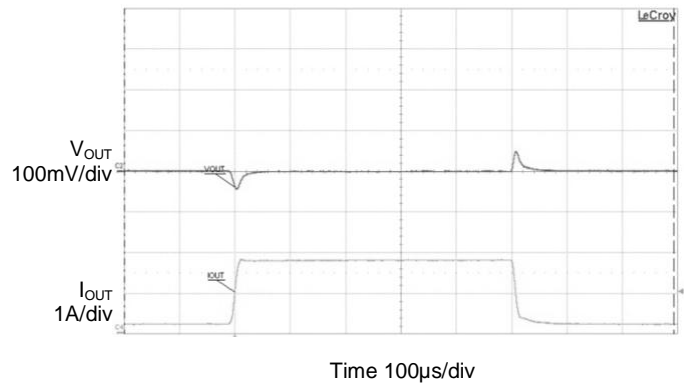

Power Dissipation vs. Temperature

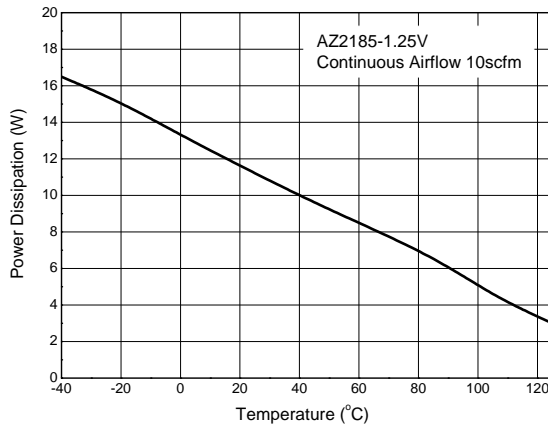

NEW PRODUCT

Ordering Information

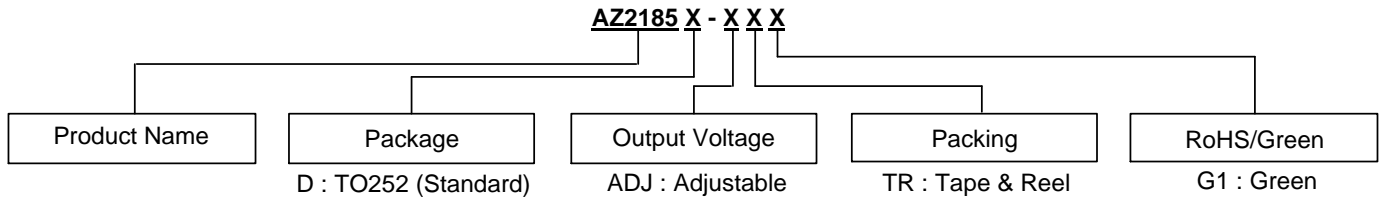

| Package | Temperature Range | Part Number | Marking ID | Packing |
|------------------|-------------------|-----------------|---------------|------------------|
| TO252 (Standard) | -40 to +125°C | AZ2185D-ADJTRG1 | AZ2185D-ADJG1 | 2500/Tape & Reel |

NEW PRODUCT

Marking Information

(1) TO252 (Standard)

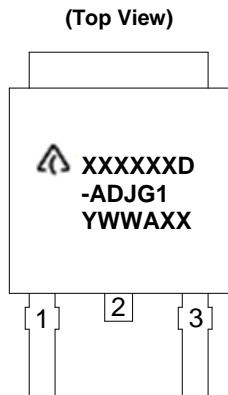

First and Second Lines: Logo and Marking ID (See Ordering Information)
 Third Line: Date Code
 Y: Year
 WW: Work Week of Molding
 A: Assembly House Code
 XX: 7th and 8th Digits of Batch Number

Package Outline Dimensions

Please see <http://www.diodes.com/package-outlines.html> for the latest version.

(1) Package Type: TO252 (Standard)

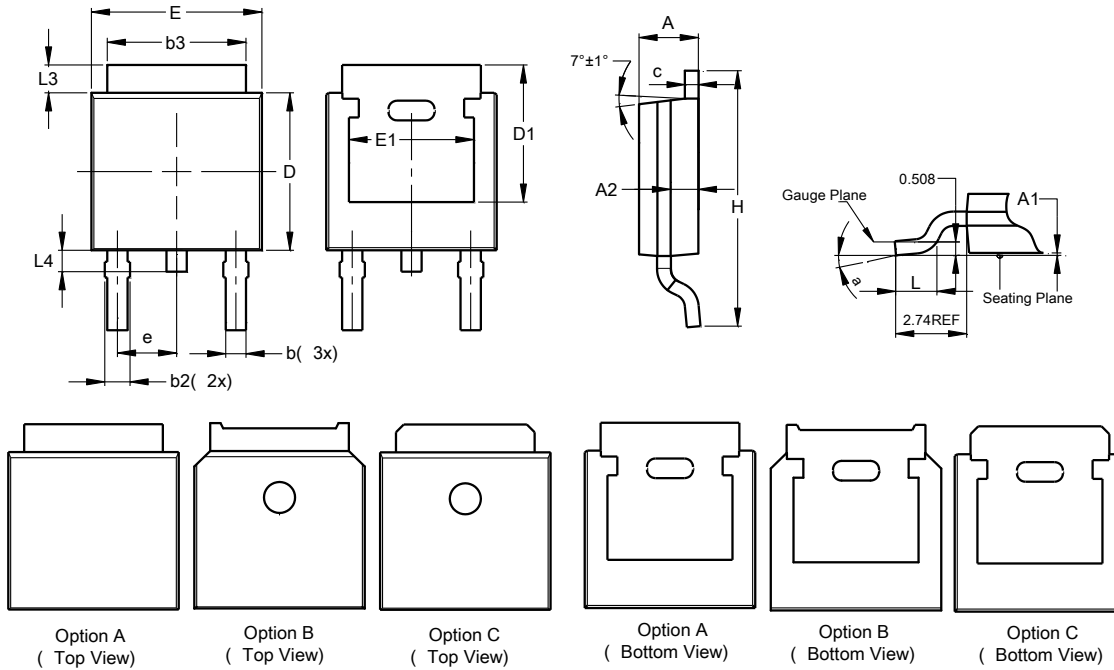

| TO252 (Standard) | | | |
|----------------------|------|-------|-------|
| Dim | Min | Max | Typ |
| A | 2.19 | 2.39 | 2.29 |
| A1 | 0.00 | 0.13 | 0.08 |
| A2 | 0.97 | 1.17 | 1.07 |
| b | 0.64 | 0.88 | 0.783 |
| b2 | 0.76 | 1.14 | 0.95 |
| b3 | 5.21 | 5.46 | 5.33 |
| c | 0.45 | 0.58 | 0.531 |
| D | 6.00 | 6.20 | 6.10 |
| D1 | 5.21 | - | - |
| e | - | - | 2.286 |
| E | 6.45 | 6.70 | 6.58 |
| E1 | 4.32 | - | - |
| H | 9.40 | 10.41 | 9.91 |
| L | 1.40 | 1.78 | 1.59 |
| L3 | 0.88 | 1.27 | 1.08 |
| L4 | 0.60 | 1.02 | 0.83 |
| a | 0° | 10° | - |
| All Dimensions in mm | | | |

Suggested Pad Layout

Please see <http://www.diodes.com/package-outlines.html> for the latest version.

(1) Package Type: TO252 (Standard)

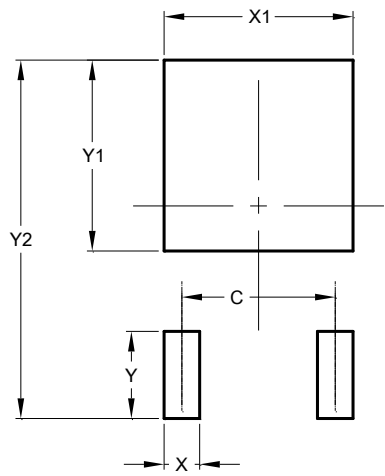

| Dimensions | Value (in mm) |
|------------|---------------|
| C | 4.572 |
| X | 1.060 |
| X1 | 5.632 |
| Y | 2.600 |
| Y1 | 5.700 |
| Y2 | 10.700 |

NEW PRODUCT

IMPORTANT NOTICE

DIODES INCORPORATED MAKES NO WARRANTY OF ANY KIND, EXPRESS OR IMPLIED, WITH REGARDS TO THIS DOCUMENT, INCLUDING, BUT NOT LIMITED TO, THE IMPLIED WARRANTIES OF MERCHANTABILITY AND FITNESS FOR A PARTICULAR PURPOSE (AND THEIR EQUIVALENTS UNDER THE LAWS OF ANY JURISDICTION).

Diodes Incorporated and its subsidiaries reserve the right to make modifications, enhancements, improvements, corrections or other changes without further notice to this document and any product described herein. Diodes Incorporated does not assume any liability arising out of the application or use of this document or any product described herein; neither does Diodes Incorporated convey any license under its patent or trademark rights, nor the rights of others. Any Customer or user of this document or products described herein in such applications shall assume all risks of such use and will agree to hold Diodes Incorporated and all the companies whose products are represented on Diodes Incorporated website, harmless against all damages.

Diodes Incorporated does not warrant or accept any liability whatsoever in respect of any products purchased through unauthorized sales channel. Should Customers purchase or use Diodes Incorporated products for any unintended or unauthorized application, Customers shall indemnify and hold Diodes Incorporated and its representatives harmless against all claims, damages, expenses, and attorney fees arising out of, directly or indirectly, any claim of personal injury or death associated with such unintended or unauthorized application.

Products described herein may be covered by one or more United States, international or foreign patents pending. Product names and markings noted herein may also be covered by one or more United States, international or foreign trademarks.

This document is written in English but may be translated into multiple languages for reference. Only the English version of this document is the final and determinative format released by Diodes Incorporated.

LIFE SUPPORT

Diodes Incorporated products are specifically not authorized for use as critical components in life support devices or systems without the express written approval of the Chief Executive Officer of Diodes Incorporated. As used herein:

A. Life support devices or systems are devices or systems which:

1. are intended to implant into the body, or
2. support or sustain life and whose failure to perform when properly used in accordance with instructions for use provided in the labeling can be reasonably expected to result in significant injury to the user.

B. A critical component is any component in a life support device or system whose failure to perform can be reasonably expected to cause the failure of the life support device or to affect its safety or effectiveness.

Customers represent that they have all necessary expertise in the safety and regulatory ramifications of their life support devices or systems, and acknowledge and agree that they are solely responsible for all legal, regulatory and safety-related requirements concerning their products and any use of Diodes Incorporated products in such safety-critical, life support devices or systems, notwithstanding any devices- or systems-related information or support that may be provided by Diodes Incorporated. Further, Customers must fully indemnify Diodes Incorporated and its representatives against any damages arising out of the use of Diodes Incorporated products in such safety-critical, life support devices or systems.

Copyright © 2017, Diodes Incorporated

www.diodes.com