

FEATURES

- Qualified for automotive applications
- Low power operation
 - 5 V operation
 - 1.2 mA per channel maximum at 0 Mbps to 2 Mbps
 - 3.5 mA per channel maximum at 10 Mbps
 - 32 mA per channel maximum at 90 Mbps
 - 3 V operation
 - 0.8 mA per channel maximum at 0 Mbps to 2 Mbps
 - 2.2 mA per channel maximum at 10 Mbps
 - 20 mA per channel maximum at 90 Mbps
- Bidirectional communication
- 3 V/5 V level translation
- High temperature operation: 125°C
- High data rate: dc to 90 Mbps (NRZ)
- Precise timing characteristics
 - 2 ns maximum pulse width distortion
 - 2 ns maximum channel-to-channel matching
- High common-mode transient immunity: >25 kV/μs
- Output enable function
- 16-lead SOIC wide body package
- RoHS-compliant models available
- Safety and regulatory approvals
 - UL recognition: 2500 V rms for 1 minute per UL 1577
 - CSA Component Acceptance Notice 5A
 - VDE Certificate of Conformity
 - DIN V VDE V 0884-10 (VDE V 0884-10):2006-12
 - V_{IORM} = 560 V peak
 - TÜV approval: IEC/EN/UL/CSA 61010-1

APPLICATIONS

- General-purpose multichannel isolation
- SPI interface/data converter isolation
- RS-232/RS-422/RS-485 transceivers
- Industrial field bus isolation
- Automotive systems

GENERAL DESCRIPTION

The ADuM1300/ADuM1301¹ are triple-channel digital isolators based on the Analog Devices, Inc., *iCoupler*® technology. Combining high speed CMOS and monolithic transformer technology, these isolation components provide outstanding performance characteristics superior to alternatives, such as optocouplers.

By avoiding the use of LEDs and photodiodes, *iCoupler* devices remove the design difficulties commonly associated with optocouplers. The typical optocoupler concerns regarding uncertain current transfer ratios, nonlinear transfer functions, and temperature and lifetime effects are eliminated with the simple *iCoupler* digital interfaces and stable performance characteristics. The need for external drivers and other discrete components is eliminated with these *iCoupler* products. Furthermore, *iCoupler* devices consume one-tenth to one-sixth of the power of optocouplers at comparable signal data rates.

The ADuM1300/ADuM1301 isolators provide three independent isolation channels in a variety of channel configurations and data rates (see the Ordering Guide). Both models operate with the supply voltage on either side ranging from 2.7 V to 5.5 V, providing compatibility with lower voltage systems as well as enabling a voltage translation functionality across the isolation barrier. In addition, the ADuM1300/ADuM1301 provide low pulse width distortion (<2 ns for CRW grade) and tight channel-to-channel matching (<2 ns for CRW grade). Unlike other optocoupler alternatives, the ADuM1300/ADuM1301 isolators have a patented refresh feature that ensures dc correctness in the absence of input logic transitions and when power is not applied to one of the supplies.

¹ Protected by U.S. Patents 5,952,849; 6,873,065; 6,903,578; and 7,075,329.

FUNCTIONAL BLOCK DIAGRAMS

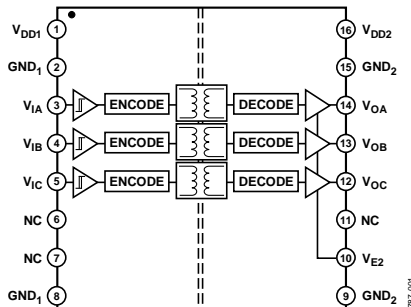

Figure 1. ADuM1300 Functional Block Diagram

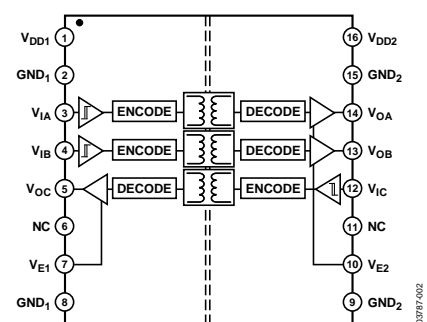

Figure 2. ADuM1301 Functional Block Diagram

Rev. K

[Document Feedback](#)

Information furnished by Analog Devices is believed to be accurate and reliable. However, no responsibility is assumed by Analog Devices for its use, nor for any infringements of patents or other rights of third parties that may result from its use. Specifications subject to change without notice. No license is granted by implication or otherwise under any patent or patent rights of Analog Devices. Trademarks and registered trademarks are the property of their respective owners.

TABLE OF CONTENTS

| | | | |
|--|----|--|----|
| Features | 1 | DIN V VDE V 0884-10 (VDE V 0884-10):2006-12 Insulation Characteristics | 20 |
| Applications | 1 | Recommended Operating Conditions | 20 |
| General Description | 1 | Absolute Maximum Ratings | 21 |
| Functional Block Diagrams | 1 | ESD Caution | 21 |
| Revision History | 3 | Pin Configurations and Function Descriptions | 22 |
| Specifications | 4 | Typical Performance Characteristics | 23 |
| Electrical Characteristics—5 V, 105°C Operation | 4 | Applications Information | 25 |
| Electrical Characteristics—3 V, 105°C Operation | 6 | Printed Circuit Board (PCB) Layout | 25 |
| Electrical Characteristics—Mixed 5 V/3 V or 3 V/5 V, 105°C Operation | 8 | Propagation Delay-Related Parameters | 25 |
| Electrical Characteristics—5 V, 125°C Operation | 11 | DC Correctness and Magnetic Field Immunity | 25 |
| Electrical Characteristics—3 V, 125°C Operation | 13 | Power Consumption | 26 |
| Electrical Characteristics—Mixed 5 V/3 V, 125°C Operation | 15 | Insulation Lifetime | 27 |
| Electrical Characteristics—Mixed 3 V/5 V, 125°C Operation | 17 | Outline Dimensions | 28 |
| Package Characteristics | 19 | Ordering Guide | 29 |
| Regulatory Information | 19 | Automotive Products | 29 |
| Insulation and Safety-Related Specifications | 19 | | |

REVISION HISTORY**11/15—Rev. J to Rev. K**

| | |
|---------------------------------------|----|
| Changes to Table 9 and Table 10 | 19 |
| Changes to Ordering Guide..... | 29 |

4/14—Rev. I to Rev. J

| | |
|-------------------------|----|
| Change to Table 9 | 19 |
|-------------------------|----|

3/12—Rev. H to Rev. I

| | |
|--|----|
| Created Hyperlink for Safety and Regulatory Approvals Entry in Features Section | 1 |
| Change to PC Board Layout Section | 25 |
| Updated Outline Dimensions..... | 28 |
| Moved Automotive Products Section..... | 28 |

5/08—Rev. G to Rev. H

| | |
|--|-----------|
| Added ADuM1300W and ADuM1301W Parts..... | Universal |
| Changes to Features List..... | 1 |
| Added Table 4 | 11 |
| Added Table 5 | 13 |
| Added Table 6 | 15 |
| Added Table 7 | 17 |
| Changes to Table 12 | 20 |
| Changes to Table 13 | 21 |
| Added Automotive Products Section | 27 |
| Changes to Ordering Guide..... | 28 |

11/07—Rev. F to Rev. G

| | |
|--|----|
| Changes to Note 1 and Figure 2 | 1 |
| Added ADuM130xARW Change vs. Temperature Parameter ... | 3 |
| Added ADuM130xARW Change vs. Temperature Parameter ... | 5 |
| Added ADuM130xARW Change vs. Temperature Parameter ... | 8 |
| Changes to Figure 14 | 16 |

6/07—Rev. E to Rev. F

| | |
|---|----|
| Updated VDE Certification Throughout..... | 1 |
| Changes to Features, Note 1, Figure 1, and Figure 2 | 1 |
| Changes to Regulatory Information Section | 10 |
| Added Table 10 | 12 |
| Added Insulation Lifetime Section | 17 |
| Updated Outline Dimensions..... | 19 |
| Changes to Ordering Guide..... | 19 |

2/06—Rev. D to Rev. E

| | |
|---------------------------|-----------|
| Updated Format | Universal |
| Added TÜV Approval | Universal |
| Changes to Figure 2 | 1 |

5/05—Rev. C to Rev. D

| | |
|--------------------------------|-----------|
| Changes to Format..... | Universal |
| Changes to Figure 2 | 1 |
| Changes to Table 6 | 10 |
| Changes to Ordering Guide..... | 18 |

6/04—Rev. B to Rev. C

| | |
|---|-----------|
| Changes to Format..... | Universal |
| Changes to Features | 1 |
| Changes to Electrical Characteristics—5 V Operation..... | 3 |
| Changes to Electrical Characteristics—3 V Operation..... | 5 |
| Changes to Electrical Characteristics—Mixed 5 V/3 V or 3 V/5 V Operation | 7 |
| Changes to Ordering Guide..... | 18 |

5/04—Rev. A to Rev. B

| | |
|--|-----------|
| Changes to the Format | Universal |
| Changes to the Features..... | 1 |
| Changes to Table 7 and Table 8 | 14 |
| Changes to Table 9 | 15 |
| Changes to the DC Correctness and Magnetic Field Immunity Section | 19 |
| Changes to the Power Consumption Section..... | 20 |
| Changes to the Ordering Guide | 21 |

9/03—Rev. 0 to Rev. A

| | |
|--|----|
| Edits to Regulatory Information | 13 |
| Edits to Absolute Maximum Ratings..... | 15 |
| Deleted the Package Branding Information | 16 |

9/03—Revision 0: Initial Version

SPECIFICATIONS

ELECTRICAL CHARACTERISTICS—5 V, 105°C OPERATION

All voltages are relative to their respective ground. $4.5\text{ V} \leq V_{DD1} \leq 5.5\text{ V}$, $4.5\text{ V} \leq V_{DD2} \leq 5.5\text{ V}$; all minimum/maximum specifications apply over the entire recommended operation range, unless otherwise noted; all typical specifications are at $T_A = 25^\circ\text{C}$, $V_{DD1} = V_{DD2} = 5\text{ V}$. These specifications do not apply to ADuM1300W and ADuM1301W automotive grade versions.

Table 1.

| Parameter | Symbol | Min | Typ | Max | Unit | Test Conditions |
|--|--|--------------------------------|-------|------|---------------|--|
| DC SPECIFICATIONS | | | | | | |
| Input Supply Current per Channel, Quiescent | $I_{DD1(Q)}$ | | 0.50 | 0.53 | mA | |
| Output Supply Current per Channel, Quiescent | $I_{DD0(Q)}$ | | 0.19 | 0.24 | mA | |
| ADuM1300 Total Supply Current, Three Channels ¹ | | | | | | |
| DC to 2 Mbps | | | | | | |
| V_{DD1} Supply Current | $I_{DD1(Q)}$ | | 1.6 | 2.5 | mA | DC to 1 MHz logic signal freq. |
| V_{DD2} Supply Current | $I_{DD2(Q)}$ | | 0.7 | 1.0 | mA | DC to 1 MHz logic signal freq. |
| 10 Mbps (BRW and CRW Grades Only) | | | | | | |
| V_{DD1} Supply Current | $I_{DD1(10)}$ | | 6.5 | 8.1 | mA | 5 MHz logic signal freq. |
| V_{DD2} Supply Current | $I_{DD2(10)}$ | | 1.9 | 2.5 | mA | 5 MHz logic signal freq. |
| 90 Mbps (CRW Grade Only) | | | | | | |
| V_{DD1} Supply Current | $I_{DD1(90)}$ | | 57 | 77 | mA | 45 MHz logic signal freq. |
| V_{DD2} Supply Current | $I_{DD2(90)}$ | | 16 | 18 | mA | 45 MHz logic signal freq. |
| ADuM1301 Total Supply Current, Three Channels ¹ | | | | | | |
| DC to 2 Mbps | | | | | | |
| V_{DD1} Supply Current | $I_{DD1(Q)}$ | | 1.3 | 2.1 | mA | DC to 1 MHz logic signal freq. |
| V_{DD2} Supply Current | $I_{DD2(Q)}$ | | 1.0 | 1.4 | mA | DC to 1 MHz logic signal freq. |
| 10 Mbps (BRW and CRW Grades Only) | | | | | | |
| V_{DD1} Supply Current | $I_{DD1(10)}$ | | 5.0 | 6.2 | mA | 5 MHz logic signal freq. |
| V_{DD2} Supply Current | $I_{DD2(10)}$ | | 3.4 | 4.2 | mA | 5 MHz logic signal freq. |
| 90 Mbps (CRW Grade Only) | | | | | | |
| V_{DD1} Supply Current | $I_{DD1(90)}$ | | 43 | 57 | mA | 45 MHz logic signal freq. |
| V_{DD2} Supply Current | $I_{DD2(90)}$ | | 29 | 37 | mA | 45 MHz logic signal freq. |
| For All Models | | | | | | |
| Input Currents | $I_{IA}, I_{IB}, I_{IC}, I_{E1}, I_{E2}$ | -10 | +0.01 | +10 | μA | $0\text{ V} \leq V_{IA}, V_{IB}, V_{IC} \leq V_{DD1}$ or V_{DD2} , $0\text{ V} \leq V_{E1}, V_{E2} \leq V_{DD1}$ or V_{DD2} |
| Logic High Input Threshold | V_{IH}, V_{EH} | 2.0 | | | V | |
| Logic Low Input Threshold | V_{IL}, V_{EL} | | | 0.8 | V | |
| Logic High Output Voltages | $V_{OAH}, V_{OBH}, V_{OCH}$ | $(V_{DD1}$ or $V_{DD2}) - 0.1$ | 5.0 | | V | $I_{Ox} = -20\ \mu\text{A}, V_{Ix} = V_{IxH}$ |
| | | $(V_{DD1}$ or $V_{DD2}) - 0.4$ | 4.8 | | V | $I_{Ox} = -4\ \text{mA}, V_{Ix} = V_{IxH}$ |
| Logic Low Output Voltages | $V_{OAL}, V_{OBL}, V_{OCL}$ | | 0.0 | 0.1 | V | $I_{Ox} = 20\ \mu\text{A}, V_{Ix} = V_{IxL}$ |
| | | | 0.04 | 0.1 | V | $I_{Ox} = 400\ \mu\text{A}, V_{Ix} = V_{IxL}$ |
| | | | 0.2 | 0.4 | V | $I_{Ox} = 4\ \text{mA}, V_{Ix} = V_{IxL}$ |
| SWITCHING SPECIFICATIONS | | | | | | |
| ADuM1300ARW/ADuM1301ARW | | | | | | |
| Minimum Pulse Width ² | PW | | | 1000 | ns | $C_L = 15\ \text{pF}$, CMOS signal levels |
| Maximum Data Rate ³ | | 1 | | | Mbps | $C_L = 15\ \text{pF}$, CMOS signal levels |
| Propagation Delay ⁴ | t_{PHL}, t_{PLH} | 50 | 65 | 100 | ns | $C_L = 15\ \text{pF}$, CMOS signal levels |
| Pulse Width Distortion, $ t_{PLH} - t_{PHL} $ ⁴ | PWD | | | 40 | ns | $C_L = 15\ \text{pF}$, CMOS signal levels |
| Change vs. Temperature | | | 11 | | ps/°C | $C_L = 15\ \text{pF}$, CMOS signal levels |
| Propagation Delay Skew ⁵ | t_{PSK} | | | 50 | ns | $C_L = 15\ \text{pF}$, CMOS signal levels |
| Channel-to-Channel Matching ⁶ | t_{PSKCD}/t_{PSKOD} | | | 50 | ns | $C_L = 15\ \text{pF}$, CMOS signal levels |

| Parameter | Symbol | Min | Typ | Max | Unit | Test Conditions |
|---|-------------------------------------|-----|------|------|---------|--|
| ADuM1300BRW/ADuM1301BRW | | | | | | |
| Minimum Pulse Width ² | PW | | | 100 | ns | C _L = 15 pF, CMOS signal levels |
| Maximum Data Rate ³ | | 10 | | | Mbps | C _L = 15 pF, CMOS signal levels |
| Propagation Delay ⁴ | t _{PHL} , t _{PLH} | 20 | 32 | 50 | ns | C _L = 15 pF, CMOS signal levels |
| Pulse Width Distortion, t _{PLH} – t _{PHL} ⁴ | PWD | | | 3 | ns | C _L = 15 pF, CMOS signal levels |
| Change vs. Temperature | | | 5 | | ps/°C | C _L = 15 pF, CMOS signal levels |
| Propagation Delay Skew ⁵ | t _{PSK} | | | 15 | ns | C _L = 15 pF, CMOS signal levels |
| Channel-to-Channel Matching, Codirectional Channels ⁶ | t _{PSKCD} | | | 3 | ns | C _L = 15 pF, CMOS signal levels |
| Channel-to-Channel Matching, Opposing-Directional Channels ⁶ | t _{PSKOD} | | | 6 | ns | C _L = 15 pF, CMOS signal levels |
| ADuM1300CRW/ADuM1301CRW | | | | | | |
| Minimum Pulse Width ² | PW | | 8.3 | 11.1 | ns | C _L = 15 pF, CMOS signal levels |
| Maximum Data Rate ³ | | 90 | 120 | | Mbps | C _L = 15 pF, CMOS signal levels |
| Propagation Delay ⁴ | t _{PHL} , t _{PLH} | 18 | 27 | 32 | ns | C _L = 15 pF, CMOS signal levels |
| Pulse Width Distortion, t _{PLH} – t _{PHL} ⁴ | PWD | | 0.5 | 2 | ns | C _L = 15 pF, CMOS signal levels |
| Change vs. Temperature | | | 3 | | ps/°C | C _L = 15 pF, CMOS signal levels |
| Propagation Delay Skew ⁵ | t _{PSK} | | | 10 | ns | C _L = 15 pF, CMOS signal levels |
| Channel-to-Channel Matching, Codirectional Channels ⁶ | t _{PSKCD} | | | 2 | ns | C _L = 15 pF, CMOS signal levels |
| Channel-to-Channel Matching, Opposing-Directional Channels ⁶ | t _{PSKOD} | | | 5 | ns | C _L = 15 pF, CMOS signal levels |
| For All Models | | | | | | |
| Output Disable Propagation Delay (High/Low to High Impedance) | t _{PHZ} , t _{PLH} | | 6 | 8 | ns | C _L = 15 pF, CMOS signal levels |
| Output Enable Propagation Delay (High Impedance to High/Low) | t _{PZH} , t _{PZL} | | 6 | 8 | ns | C _L = 15 pF, CMOS signal levels |
| Output Rise/Fall Time (10% to 90%) | t _R /t _F | | 2.5 | | ns | C _L = 15 pF, CMOS signal levels |
| Common-Mode Transient Immunity at Logic High Output ⁷ | CM _H | 25 | 35 | | kV/μs | V _{ix} = V _{DD1} or V _{DD2} , V _{CM} = 1000 V, transient magnitude = 800 V |
| Common-Mode Transient Immunity at Logic Low Output ⁷ | CM _L | 25 | 35 | | kV/μs | V _{ix} = 0 V, V _{CM} = 1000 V, transient magnitude = 800 V |
| Refresh Rate | f _r | | 1.2 | | Mbps | |
| Input Dynamic Supply Current per Channel ⁸ | I _{DDI (D)} | | 0.19 | | mA/Mbps | |
| Output Dynamic Supply Current per Channel ⁸ | I _{DDO (D)} | | 0.05 | | mA/Mbps | |

¹ The supply current values are for all three channels combined when running at identical data rates. Output supply current values are specified with no output load present. The supply current associated with an individual channel operating at a given data rate may be calculated as described in the Power Consumption section. See Figure 6 through Figure 8 for information on per-channel supply current as a function of data rate for unloaded and loaded conditions. See Figure 9 through Figure 12 for total V_{DD1} and V_{DD2} supply currents as a function of data rate for ADuM1300/ADuM1301 channel configurations.

² The minimum pulse width is the shortest pulse width at which the specified pulse width distortion is guaranteed.

³ The maximum data rate is the fastest data rate at which the specified pulse width distortion is guaranteed.

⁴ t_{PHL} propagation delay is measured from the 50% level of the falling edge of the V_{ix} signal to the 50% level of the falling edge of the V_{ox} signal. t_{PLH} propagation delay is measured from the 50% level of the rising edge of the V_{ix} signal to the 50% level of the rising edge of the V_{ox} signal.

⁵ t_{PSK} is the magnitude of the worst-case difference in t_{PHL} or t_{PLH} that is measured between units at the same operating temperature, supply voltages, and output load within the recommended operating conditions.

⁶ Codirectional channel-to-channel matching is the absolute value of the difference in propagation delays between any two channels with inputs on the same side of the isolation barrier. Opposing-directional channel-to-channel matching is the absolute value of the difference in propagation delays between any two channels with inputs on opposing sides of the isolation barrier.

⁷ CM_H is the maximum common-mode voltage slew rate that can be sustained while maintaining V_O > 0.8 V_{DD2}. CM_L is the maximum common-mode voltage slew rate that can be sustained while maintaining V_O < 0.8 V. The common-mode voltage slew rates apply to both rising and falling common-mode voltage edges. The transient magnitude is the range over which the common mode is slewed.

⁸ Dynamic supply current is the incremental amount of supply current required for a 1 Mbps increase in signal data rate. See Figure 6 through Figure 8 for information on per-channel supply current for unloaded and loaded conditions. See the Power Consumption section for guidance on calculating the per-channel supply current for a given data rate.

ELECTRICAL CHARACTERISTICS—3 V, 105°C OPERATION

All voltages are relative to their respective ground. $2.7\text{ V} \leq V_{DD1} \leq 3.6\text{ V}$, $2.7\text{ V} \leq V_{DD2} \leq 3.6\text{ V}$; all minimum/maximum specifications apply over the entire recommended operation range, unless otherwise noted; all typical specifications are at $T_A = 25^\circ\text{C}$, $V_{DD1} = V_{DD2} = 3.0\text{ V}$.

These specifications do not apply to [ADuM1300W](#) and [ADuM1301W](#) automotive grade versions.

Table 2.

| Parameter | Symbol | Min | Typ | Max | Unit | Test Conditions |
|--|--|--------------------------------|-------|------|----------------------|--|
| DC SPECIFICATIONS | | | | | | |
| Input Supply Current per Channel, Quiescent | $I_{DD1(Q)}$ | | 0.26 | 0.31 | mA | |
| Output Supply Current per Channel, Quiescent | $I_{DDO(Q)}$ | | 0.11 | 0.15 | mA | |
| ADuM1300 Total Supply Current, Three Channels ¹ | | | | | | |
| DC to 2 Mbps | | | | | | |
| V_{DD1} Supply Current | $I_{DD1(Q)}$ | | 0.9 | 1.7 | mA | DC to 1 MHz logic signal freq. |
| V_{DD2} Supply Current | $I_{DD2(Q)}$ | | 0.4 | 0.7 | mA | DC to 1 MHz logic signal freq. |
| 10 Mbps (BRW and CRW Grades Only) | | | | | | |
| V_{DD1} Supply Current | $I_{DD1(10)}$ | | 3.4 | 4.9 | mA | 5 MHz logic signal freq. |
| V_{DD2} Supply Current | $I_{DD2(10)}$ | | 1.1 | 1.6 | mA | 5 MHz logic signal freq. |
| 90 Mbps (CRW Grade Only) | | | | | | |
| V_{DD1} Supply Current | $I_{DD1(90)}$ | | 31 | 48 | mA | 45 MHz logic signal freq. |
| V_{DD2} Supply Current | $I_{DD2(90)}$ | | 8 | 13 | mA | 45 MHz logic signal freq. |
| ADuM1301 Total Supply Current, Three Channels ¹ | | | | | | |
| DC to 2 Mbps | | | | | | |
| V_{DD1} Supply Current | $I_{DD1(Q)}$ | | 0.7 | 1.4 | mA | DC to 1 MHz logic signal freq. |
| V_{DD2} Supply Current | $I_{DD2(Q)}$ | | 0.6 | 0.9 | mA | DC to 1 MHz logic signal freq. |
| 10 Mbps (BRW and CRW Grades Only) | | | | | | |
| V_{DD1} Supply Current | $I_{DD1(10)}$ | | 2.6 | 3.7 | mA | 5 MHz logic signal freq. |
| V_{DD2} Supply Current | $I_{DD2(10)}$ | | 1.8 | 2.5 | mA | 5 MHz logic signal freq. |
| 90 Mbps (CRW Grade Only) | | | | | | |
| V_{DD1} Supply Current | $I_{DD1(90)}$ | | 24 | 36 | mA | 45 MHz logic signal freq. |
| V_{DD2} Supply Current | $I_{DD2(90)}$ | | 16 | 23 | mA | 45 MHz logic signal freq. |
| For All Models | | | | | | |
| Input Currents | $I_{IA}, I_{IB}, I_{IC}, I_{E1}, I_{E2}$ | -10 | +0.01 | +10 | μA | $0\text{ V} \leq V_{IA}, V_{IB}, V_{IC} \leq V_{DD1}$ or V_{DD2} , $0\text{ V} \leq V_{E1}, V_{E2} \leq V_{DD1}$ or V_{DD2} |
| Logic High Input Threshold | V_{IH}, V_{EH} | 1.6 | | | V | |
| Logic Low Input Threshold | V_{IL}, V_{EL} | | | 0.4 | V | |
| Logic High Output Voltages | $V_{OAH}, V_{OBH}, V_{OCH}$ | $(V_{DD1}$ or $V_{DD2}) - 0.1$ | 3.0 | | V | $I_{OX} = -20\ \mu\text{A}, V_{IX} = V_{IXH}$ |
| | | $(V_{DD1}$ or $V_{DD2}) - 0.4$ | 2.8 | | V | $I_{OX} = -4\ \text{mA}, V_{IX} = V_{IXH}$ |
| Logic Low Output Voltages | $V_{OAL}, V_{OBL}, V_{OCL}$ | | 0.0 | 0.1 | V | $I_{OX} = 20\ \mu\text{A}, V_{IX} = V_{IXL}$ |
| | | | 0.04 | 0.1 | V | $I_{OX} = 400\ \mu\text{A}, V_{IX} = V_{IXL}$ |
| | | | 0.2 | 0.4 | V | $I_{OX} = 4\ \text{mA}, V_{IX} = V_{IXL}$ |
| SWITCHING SPECIFICATIONS | | | | | | |
| ADuM1300ARW/ADuM1301ARW | | | | | | |
| Minimum Pulse Width ² | PW | | | 1000 | ns | $C_L = 15\ \text{pF}$, CMOS signal levels |
| Maximum Data Rate ³ | | 1 | | | Mbps | $C_L = 15\ \text{pF}$, CMOS signal levels |
| Propagation Delay ⁴ | t_{PHL}, t_{PLH} | 50 | 75 | 100 | ns | $C_L = 15\ \text{pF}$, CMOS signal levels |
| Pulse Width Distortion, $ t_{PLH} - t_{PHL} $ ⁴ | PWD | | | 40 | ns | $C_L = 15\ \text{pF}$, CMOS signal levels |
| Change vs. Temperature | | | 11 | | ps/ $^\circ\text{C}$ | $C_L = 15\ \text{pF}$, CMOS signal levels |
| Propagation Delay Skew ⁵ | t_{PSK} | | | 50 | ns | $C_L = 15\ \text{pF}$, CMOS signal levels |
| Channel-to-Channel Matching ⁶ | t_{PSKCD}/t_{PSKOD} | | | 50 | ns | $C_L = 15\ \text{pF}$, CMOS signal levels |

| Parameter | Symbol | Min | Typ | Max | Unit | Test Conditions |
|---|-------------------------------------|-----|------|------|---------|--|
| ADuM1300BRW/ADuM1301BRW | | | | | | |
| Minimum Pulse Width ² | PW | | | 100 | ns | C _L = 15 pF, CMOS signal levels |
| Maximum Data Rate ³ | | 10 | | | Mbps | C _L = 15 pF, CMOS signal levels |
| Propagation Delay ⁴ | t _{PHL} , t _{PLH} | 20 | 38 | 50 | ns | C _L = 15 pF, CMOS signal levels |
| Pulse Width Distortion, t _{PLH} – t _{PHL} ⁴ | PWD | | | 3 | ns | C _L = 15 pF, CMOS signal levels |
| Change vs. Temperature | | | 5 | | ps/°C | C _L = 15 pF, CMOS signal levels |
| Propagation Delay Skew ⁵ | t _{PSK} | | | 26 | ns | C _L = 15 pF, CMOS signal levels |
| Channel-to-Channel Matching, Codirectional Channels ⁶ | t _{PSKCD} | | | 3 | ns | C _L = 15 pF, CMOS signal levels |
| Channel-to-Channel Matching, Opposing-Directional Channels ⁶ | t _{PSKOD} | | | 6 | ns | C _L = 15 pF, CMOS signal levels |
| ADuM1300CRW/ADuM1301CRW | | | | | | |
| Minimum Pulse Width ² | PW | | 8.3 | 11.1 | ns | C _L = 15 pF, CMOS signal levels |
| Maximum Data Rate ³ | | 90 | 120 | | Mbps | C _L = 15 pF, CMOS signal levels |
| Propagation Delay ⁴ | t _{PHL} , t _{PLH} | 20 | 34 | 45 | ns | C _L = 15 pF, CMOS signal levels |
| Pulse Width Distortion, t _{PLH} – t _{PHL} ⁴ | PWD | | 0.5 | 2 | ns | C _L = 15 pF, CMOS signal levels |
| Change vs. Temperature | | | 3 | | ps/°C | C _L = 15 pF, CMOS signal levels |
| Propagation Delay Skew ⁵ | t _{PSK} | | | 16 | ns | C _L = 15 pF, CMOS signal levels |
| Channel-to-Channel Matching, Codirectional Channels ⁶ | t _{PSKCD} | | | 2 | ns | C _L = 15 pF, CMOS signal levels |
| Channel-to-Channel Matching, Opposing-Directional Channels ⁶ | t _{PSKOD} | | | 5 | ns | C _L = 15 pF, CMOS signal levels |
| For All Models | | | | | | |
| Output Disable Propagation Delay (High/Low to High Impedance) | t _{PHZ} , t _{PLH} | | 6 | 8 | ns | C _L = 15 pF, CMOS signal levels |
| Output Enable Propagation Delay (High Impedance to High/Low) | t _{PZH} , t _{PZL} | | 6 | 8 | ns | C _L = 15 pF, CMOS signal levels |
| Output Rise/Fall Time (10% to 90%) | t _R /t _F | | 3 | | ns | C _L = 15 pF, CMOS signal levels |
| Common-Mode Transient Immunity at Logic High Output ⁷ | CM _H | 25 | 35 | | kV/μs | V _{ix} = V _{DD1} or V _{DD2} , V _{CM} = 1000 V, transient magnitude = 800 V |
| Common-Mode Transient Immunity at Logic Low Output ⁷ | CM _L | 25 | 35 | | kV/μs | V _{ix} = 0 V, V _{CM} = 1000 V, transient magnitude = 800 V |
| Refresh Rate | f _r | | 1.1 | | Mbps | |
| Input Dynamic Supply Current per Channel ⁸ | I _{DDI} (D) | | 0.10 | | mA/Mbps | |
| Output Dynamic Supply Current per Channel ⁸ | I _{DDO} (D) | | 0.03 | | mA/Mbps | |

¹ The supply current values are for all three channels combined when running at identical data rates. Output supply current values are specified with no output load present. The supply current associated with an individual channel operating at a given data rate may be calculated as described in the Power Consumption section. See Figure 6 through Figure 8 for information on per-channel supply current as a function of data rate for unloaded and loaded conditions. See Figure 9 through Figure 12 for total V_{DD1} and V_{DD2} supply currents as a function of data rate for ADuM1300/ADuM1301 channel configurations.

² The minimum pulse width is the shortest pulse width at which the specified pulse width distortion is guaranteed.

³ The maximum data rate is the fastest data rate at which the specified pulse width distortion is guaranteed.

⁴ t_{PHL} propagation delay is measured from the 50% level of the falling edge of the V_{ix} signal to the 50% level of the falling edge of the V_{ox} signal. t_{PLH} propagation delay is measured from the 50% level of the rising edge of the V_{ix} signal to the 50% level of the rising edge of the V_{ox} signal.

⁵ t_{PSK} is the magnitude of the worst-case difference in t_{PHL} or t_{PLH} that is measured between units at the same operating temperature, supply voltages, and output load within the recommended operating conditions.

⁶ Codirectional channel-to-channel matching is the absolute value of the difference in propagation delays between any two channels with inputs on the same side of the isolation barrier. Opposing-directional channel-to-channel matching is the absolute value of the difference in propagation delays between any two channels with inputs on opposing sides of the isolation barrier.

⁷ CM_H is the maximum common-mode voltage slew rate that can be sustained while maintaining V_O > 0.8 V_{DD2}. CM_L is the maximum common-mode voltage slew rate that can be sustained while maintaining V_O < 0.8 V. The common-mode voltage slew rates apply to both rising and falling common-mode voltage edges. The transient magnitude is the range over which the common mode is slewed.

⁸ Dynamic supply current is the incremental amount of supply current required for a 1 Mbps increase in signal data rate. See Figure 6 through Figure 8 for information on per-channel supply current for unloaded and loaded conditions. See the Power Consumption section for guidance on calculating the per-channel supply current for a given data rate.

ELECTRICAL CHARACTERISTICS—MIXED 5 V/3 V OR 3 V/5 V, 105°C OPERATION

All voltages are relative to their respective ground. 5 V/3 V operation: $4.5\text{ V} \leq V_{DD1} \leq 5.5\text{ V}$, $2.7\text{ V} \leq V_{DD2} \leq 3.6\text{ V}$; 3 V/5 V operation: $2.7\text{ V} \leq V_{DD1} \leq 3.6\text{ V}$, $4.5\text{ V} \leq V_{DD2} \leq 5.5\text{ V}$; all minimum/maximum specifications apply over the entire recommended operation range, unless otherwise noted; all typical specifications are at $T_A = 25^\circ\text{C}$; $V_{DD1} = 3.0\text{ V}$, $V_{DD2} = 5\text{ V}$ or $V_{DD1} = 5\text{ V}$, $V_{DD2} = 3.0\text{ V}$. These specifications do not apply to [ADuM1300W](#) and [ADuM1301W](#) automotive grade versions.

Table 3.

| Parameter | Symbol | Min | Typ | Max | Unit | Test Conditions |
|--|---------------|-----|------|------|------|--------------------------------|
| DC SPECIFICATIONS | | | | | | |
| Input Supply Current per Channel, Quiescent | $I_{DD1(Q)}$ | | | | | |
| 5 V/3 V Operation | | | 0.50 | 0.53 | mA | |
| 3 V/5 V Operation | | | 0.26 | 0.31 | mA | |
| Output Supply Current per Channel, Quiescent | $I_{DDO(Q)}$ | | | | | |
| 5 V/3 V Operation | | | 0.11 | 0.15 | mA | |
| 3 V/5 V Operation | | | 0.19 | 0.24 | mA | |
| ADuM1300 Total Supply Current, Three Channels ¹ | | | | | | |
| DC to 2 Mbps | | | | | | |
| V_{DD1} Supply Current | $I_{DD1(Q)}$ | | | | | |
| 5 V/3 V Operation | | | 1.6 | 2.5 | mA | DC to 1 MHz logic signal freq. |
| 3 V/5 V Operation | | | 0.9 | 1.7 | mA | DC to 1 MHz logic signal freq. |
| V_{DD2} Supply Current | $I_{DD2(Q)}$ | | | | | |
| 5 V/3 V Operation | | | 0.4 | 0.7 | mA | DC to 1 MHz logic signal freq. |
| 3 V/5 V Operation | | | 0.7 | 1.0 | mA | DC to 1 MHz logic signal freq. |
| 10 Mbps (BRW and CRW Grades Only) | | | | | | |
| V_{DD1} Supply Current | $I_{DD1(10)}$ | | | | | |
| 5 V/3 V Operation | | | 6.5 | 8.1 | mA | 5 MHz logic signal freq. |
| 3 V/5 V Operation | | | 3.4 | 4.9 | mA | 5 MHz logic signal freq. |
| V_{DD2} Supply Current | $I_{DD2(10)}$ | | | | | |
| 5 V/3 V Operation | | | 1.1 | 1.6 | mA | 5 MHz logic signal freq. |
| 3 V/5 V Operation | | | 1.9 | 2.5 | mA | 5 MHz logic signal freq. |
| 90 Mbps (CRW Grade Only) | | | | | | |
| V_{DD1} Supply Current | $I_{DD1(90)}$ | | | | | |
| 5 V/3 V Operation | | | 57 | 77 | mA | 45 MHz logic signal freq. |
| 3 V/5 V Operation | | | 31 | 48 | mA | 45 MHz logic signal freq. |
| V_{DD2} Supply Current | $I_{DD2(90)}$ | | | | | |
| 5 V/3 V Operation | | | 8 | 13 | mA | 45 MHz logic signal freq. |
| 3 V/5 V Operation | | | 16 | 18 | mA | 45 MHz logic signal freq. |
| ADuM1301 Total Supply Current, Three Channels ¹ | | | | | | |
| DC to 2 Mbps | | | | | | |
| V_{DD1} Supply Current | $I_{DD1(Q)}$ | | | | | |
| 5 V/3 V Operation | | | 1.3 | 2.1 | mA | DC to 1 MHz logic signal freq. |
| 3 V/5 V Operation | | | 0.7 | 1.4 | mA | DC to 1 MHz logic signal freq. |
| V_{DD2} Supply Current | $I_{DD2(Q)}$ | | | | | |
| 5 V/3 V Operation | | | 0.6 | 0.9 | mA | DC to 1 MHz logic signal freq. |
| 3 V/5 V Operation | | | 1.0 | 1.4 | mA | DC to 1 MHz logic signal freq. |
| 10 Mbps (BRW and CRW Grades Only) | | | | | | |
| V_{DD1} Supply Current | $I_{DD1(10)}$ | | | | | |
| 5 V/3 V Operation | | | 5.0 | 6.2 | mA | 5 MHz logic signal freq. |
| 3 V/5 V Operation | | | 2.6 | 3.7 | mA | 5 MHz logic signal freq. |
| V_{DD2} Supply Current | $I_{DD2(10)}$ | | | | | |
| 5 V/3 V Operation | | | 1.8 | 2.5 | mA | 5 MHz logic signal freq. |
| 3 V/5 V Operation | | | 3.4 | 4.2 | mA | 5 MHz logic signal freq. |

| Parameter | Symbol | Min | Typ | Max | Unit | Test Conditions |
|---|---|---|-------|------|-------|--|
| 90 Mbps (CRW Grade Only) | | | | | | |
| V _{DD1} Supply Current | I _{DD1(90)} | | | | | |
| 5 V/3 V Operation | | | 43 | 57 | mA | 45 MHz logic signal freq. |
| 3 V/5 V Operation | | | 24 | 36 | mA | 45 MHz logic signal freq. |
| V _{DD2} Supply Current | I _{DD2(90)} | | | | | |
| 5 V/3 V Operation | | | 16 | 23 | mA | 45 MHz logic signal freq. |
| 3 V/5 V Operation | | | 29 | 37 | mA | 45 MHz logic signal freq. |
| For All Models | | | | | | |
| Input Currents | I _{IA} , I _{IB} , I _{IC} , I _{E1} , I _{E2} | -10 | +0.01 | +10 | μA | 0 V ≤ V _{IA} , V _{IB} , V _{IC} ≤ V _{DD1} or V _{DD2} , 0 V ≤ V _{E1} , V _{E2} ≤ V _{DD1} or V _{DD2} |
| Logic High Input Threshold | V _{IH} , V _{EH} | | | | | |
| 5 V/3 V Operation | | 2.0 | | | V | |
| 3 V/5 V Operation | | 1.6 | | | V | |
| Logic Low Input Threshold | V _{IL} , V _{EL} | | | | | |
| 5 V/3 V Operation | | | | 0.8 | V | |
| 3 V/5 V Operation | | | | 0.4 | V | |
| Logic High Output Voltages | V _{OAH} , V _{OBH} , V _{OCH} | (V _{DD1} or V _{DD2}) - 0.1 (V _{DD1} or V _{DD2}) | | | V | I _{Ox} = -20 μA, V _{Ix} = V _{IxH} |
| | | (V _{DD1} or V _{DD2}) - 0.4 (V _{DD1} or V _{DD2}) - 0.2 | | | V | I _{Ox} = -4 mA, V _{Ix} = V _{IxH} |
| Logic Low Output Voltages | V _{OAL} , V _{OBL} , V _{OCL} | | 0.0 | 0.1 | V | I _{Ox} = 20 μA, V _{Ix} = V _{IxL} |
| | | | 0.04 | 0.1 | V | I _{Ox} = 400 μA, V _{Ix} = V _{IxL} |
| | | | 0.2 | 0.4 | V | I _{Ox} = 4 mA, V _{Ix} = V _{IxL} |
| SWITCHING SPECIFICATIONS | | | | | | |
| ADuM1300ARW/ADuM1301ARW | | | | | | |
| Minimum Pulse Width ² | PW | | | 1000 | ns | C _L = 15 pF, CMOS signal levels |
| Maximum Data Rate ³ | | 1 | | | Mbps | C _L = 15 pF, CMOS signal levels |
| Propagation Delay ⁴ | t _{PHL} , t _{PLH} | 50 | 70 | 100 | ns | C _L = 15 pF, CMOS signal levels |
| Pulse Width Distortion, t _{PLH} - t _{PHL} ⁴ | PWD | | | 40 | ns | C _L = 15 pF, CMOS signal levels |
| Change vs. Temperature | | | 11 | | ps/°C | C _L = 15 pF, CMOS signal levels |
| Propagation Delay Skew ⁵ | t _{PSK} | | | 50 | ns | C _L = 15 pF, CMOS signal levels |
| Channel-to-Channel Matching ⁶ | t _{PSKCD} /t _{PSKOD} | | | 50 | ns | C _L = 15 pF, CMOS signal levels |
| ADuM1300BRW/ADuM1301BRW | | | | | | |
| Minimum Pulse Width ² | PW | | | 100 | ns | C _L = 15 pF, CMOS signal levels |
| Maximum Data Rate ³ | | 10 | | | Mbps | C _L = 15 pF, CMOS signal levels |
| Propagation Delay ⁴ | t _{PHL} , t _{PLH} | 15 | 35 | 50 | ns | C _L = 15 pF, CMOS signal levels |
| Pulse Width Distortion, t _{PLH} - t _{PHL} ⁴ | PWD | | | 3 | ns | C _L = 15 pF, CMOS signal levels |
| Change vs. Temperature | | | 5 | | ps/°C | C _L = 15 pF, CMOS signal levels |
| Propagation Delay Skew ⁵ | t _{PSK} | | | 6 | ns | C _L = 15 pF, CMOS signal levels |
| Channel-to-Channel Matching, Codirectional Channels ⁶ | t _{PSKCD} | | | 3 | ns | C _L = 15 pF, CMOS signal levels |
| Channel-to-Channel Matching, Opposing-Directional Channels ⁶ | t _{PSKOD} | | | 22 | ns | C _L = 15 pF, CMOS signal levels |
| ADuM1300CRW/ADuM1301CRW | | | | | | |
| Minimum Pulse Width ² | PW | | 8.3 | 11.1 | ns | C _L = 15 pF, CMOS signal levels |
| Maximum Data Rate ³ | | 90 | 120 | | Mbps | C _L = 15 pF, CMOS signal levels |
| Propagation Delay ⁴ | t _{PHL} , t _{PLH} | 20 | 30 | 40 | ns | C _L = 15 pF, CMOS signal levels |
| Pulse Width Distortion, t _{PLH} - t _{PHL} ⁴ | PWD | | 0.5 | 2 | ns | C _L = 15 pF, CMOS signal levels |
| Change vs. Temperature | | | 3 | | ps/°C | C _L = 15 pF, CMOS signal levels |
| Propagation Delay Skew ⁵ | t _{PSK} | | | 14 | ns | C _L = 15 pF, CMOS signal levels |
| Channel-to-Channel Matching, Codirectional Channels ⁶ | t _{PSKCD} | | | 2 | ns | C _L = 15 pF, CMOS signal levels |
| Channel-to-Channel Matching, Opposing-Directional Channels ⁶ | t _{PSKOD} | | | 5 | ns | C _L = 15 pF, CMOS signal levels |

| Parameter | Symbol | Min | Typ | Max | Unit | Test Conditions |
|--|--------------------|-----|------|-----|-------------|---|
| For All Models | | | | | | |
| Output Disable Propagation Delay (High/Low to High Impedance) | t_{PHZ}, t_{PLH} | | 6 | 8 | ns | $C_L = 15 \text{ pF}$, CMOS signal levels |
| Output Enable Propagation Delay (High Impedance to High/Low) | t_{PZH}, t_{PZL} | | 6 | 8 | ns | $C_L = 15 \text{ pF}$, CMOS signal levels |
| Output Rise/Fall Time (10% to 90%) | t_R/t_F | | | | | $C_L = 15 \text{ pF}$, CMOS signal levels |
| 5 V/3 V Operation | | | 3.0 | | ns | |
| 3 V/5 V Operation | | | 2.5 | | ns | |
| Common-Mode Transient Immunity at Logic High Output ⁷ | $ CM_H $ | 25 | 35 | | kV/ μ s | $V_{ix} = V_{DD1}$ or V_{DD2} , $V_{CM} = 1000 \text{ V}$, transient magnitude = 800 V |
| Common-Mode Transient Immunity at Logic Low Output ⁷ | $ CM_L $ | 25 | 35 | | kV/ μ s | $V_{ix} = 0 \text{ V}$, $V_{CM} = 1000 \text{ V}$, transient magnitude = 800 V |
| Refresh Rate | f_r | | | | | |
| 5 V/3 V Operation | | | 1.2 | | Mbps | |
| 3 V/5 V Operation | | | 1.1 | | Mbps | |
| Input Dynamic Supply Current per Channel ⁸ | $I_{DDI(D)}$ | | | | | |
| 5 V/3 V Operation | | | 0.19 | | mA/Mbps | |
| 3 V/5 V Operation | | | 0.10 | | mA/Mbps | |
| Output Dynamic Supply Current per Channel ⁸ | $I_{DDO(D)}$ | | | | | |
| 5 V/3 V Operation | | | 0.03 | | mA/Mbps | |
| 3 V/5 V Operation | | | 0.05 | | mA/Mbps | |

¹ The supply current values are for all three channels combined when running at identical data rates. Output supply current values are specified with no output load present. The supply current associated with an individual channel operating at a given data rate may be calculated as described in the Power Consumption section. See Figure 6 through Figure 8 for information on per-channel supply current as a function of data rate for unloaded and loaded conditions. See Figure 9 through Figure 12 for total V_{DD1} and V_{DD2} supply currents as a function of data rate for ADuM1300/ADuM1301 channel configurations.

² The minimum pulse width is the shortest pulse width at which the specified pulse width distortion is guaranteed.

³ The maximum data rate is the fastest data rate at which the specified pulse width distortion is guaranteed.

⁴ t_{PHL} propagation delay is measured from the 50% level of the falling edge of the V_{ix} signal to the 50% level of the falling edge of the V_{ox} signal. t_{PLH} propagation delay is measured from the 50% level of the rising edge of the V_{ix} signal to the 50% level of the rising edge of the V_{ox} signal.

⁵ t_{PSK} is the magnitude of the worst-case difference in t_{PHL} or t_{PLH} that is measured between units at the same operating temperature, supply voltages, and output load within the recommended operating conditions.

⁶ Codirectional channel-to-channel matching is the absolute value of the difference in propagation delays between any two channels with inputs on the same side of the isolation barrier. Opposing-directional channel-to-channel matching is the absolute value of the difference in propagation delays between any two channels with inputs on opposing sides of the isolation barrier.

⁷ CM_H is the maximum common-mode voltage slew rate that can be sustained while maintaining $V_O > 0.8 V_{DD2}$. CM_L is the maximum common-mode voltage slew rate that can be sustained while maintaining $V_O < 0.8 \text{ V}$. The common-mode voltage slew rates apply to both rising and falling common-mode voltage edges. The transient magnitude is the range over which the common mode is slewed.

⁸ Dynamic supply current is the incremental amount of supply current required for a 1 Mbps increase in signal data rate. See Figure 6 through Figure 8 for information on per-channel supply current for unloaded and loaded conditions. See the Power Consumption section for guidance on calculating the per-channel supply current for a given data rate.

ELECTRICAL CHARACTERISTICS—5 V, 125°C OPERATION

All voltages are relative to their respective ground. $4.5\text{ V} \leq V_{DD1} \leq 5.5\text{ V}$, $4.5\text{ V} \leq V_{DD2} \leq 5.5\text{ V}$; all minimum/maximum specifications apply over the entire recommended operation range, unless otherwise noted; all typical specifications are at $T_A = 25^\circ\text{C}$, $V_{DD1} = V_{DD2} = 5\text{ V}$. These specifications apply to [ADuM1300W](#) and [ADuM1301W](#) automotive grade versions.

Table 4.

| Parameter | Symbol | Min | Typ | Max | Unit | Test Conditions |
|---|--|--------------------------|-------|------|----------------------|--|
| DC SPECIFICATIONS | | | | | | |
| Input Supply Current per Channel, Quiescent | $I_{DD1(Q)}$ | | 0.50 | 0.53 | mA | |
| Output Supply Current per Channel, Quiescent | $I_{DDO(Q)}$ | | 0.19 | 0.24 | mA | |
| ADuM1300W , Total Supply Current, Three Channels ¹ | | | | | | |
| DC to 2 Mbps | | | | | | |
| V_{DD1} Supply Current | $I_{DD1(Q)}$ | | 1.6 | 2.5 | mA | DC to 1 MHz logic signal freq. |
| V_{DD2} Supply Current | $I_{DD2(Q)}$ | | 0.7 | 1.0 | mA | DC to 1 MHz logic signal freq. |
| 10 Mbps (TRWZ Grade Only) | | | | | | |
| V_{DD1} Supply Current | $I_{DD1(10)}$ | | 6.5 | 8.1 | mA | 5 MHz logic signal freq. |
| V_{DD2} Supply Current | $I_{DD2(10)}$ | | 1.9 | 2.5 | mA | 5 MHz logic signal freq. |
| ADuM1301W , Total Supply Current, Three Channels ¹ | | | | | | |
| DC to 2 Mbps | | | | | | |
| V_{DD1} Supply Current | $I_{DD1(Q)}$ | | 1.3 | 2.1 | mA | DC to 1 MHz logic signal freq. |
| V_{DD2} Supply Current | $I_{DD2(Q)}$ | | 1.0 | 1.4 | mA | DC to 1 MHz logic signal freq. |
| 10 Mbps (TRWZ Grade Only) | | | | | | |
| V_{DD1} Supply Current | $I_{DD1(10)}$ | | 5.0 | 6.2 | mA | 5 MHz logic signal freq. |
| V_{DD2} Supply Current | $I_{DD2(10)}$ | | 3.4 | 4.2 | mA | 5 MHz logic signal freq. |
| For All Models | | | | | | |
| Input Currents | $I_{IA}, I_{IB}, I_{IC}, I_{E1}, I_{E2}$ | -10 | +0.01 | +10 | μA | $0\text{ V} \leq V_{IA}, V_{IB}, V_{IC} \leq V_{DD1}$ or V_{DD2} , $0\text{ V} \leq V_{E1}, V_{E2} \leq V_{DD1}$ or V_{DD2} |
| Logic High Input Threshold | V_{IH}, V_{EH} | 2.0 | | | V | |
| Logic Low Input Threshold | V_{IL}, V_{EL} | | | 0.8 | V | |
| Logic High Output Voltages | $V_{OAH}, V_{OBH}, V_{OCH}$ | $V_{DD1}, V_{DD2} - 0.1$ | 5.0 | | V | $I_{Ox} = -20\ \mu\text{A}, V_{Ix} = V_{IxH}$ |
| | | $V_{DD1}, V_{DD2} - 0.4$ | 4.8 | | V | $I_{Ox} = -4\ \text{mA}, V_{Ix} = V_{IxH}$ |
| Logic Low Output Voltages | $V_{OAL}, V_{OBL}, V_{OCL}$ | | 0.0 | 0.1 | V | $I_{Ox} = 20\ \mu\text{A}, V_{Ix} = V_{IxL}$ |
| | | | 0.04 | 0.1 | V | $I_{Ox} = 400\ \mu\text{A}, V_{Ix} = V_{IxL}$ |
| | | | 0.2 | 0.4 | V | $I_{Ox} = 4\ \text{mA}, V_{Ix} = V_{IxL}$ |
| SWITCHING SPECIFICATIONS | | | | | | |
| ADuM1300WSRWZ/ADuM1301WSRWZ | | | | | | |
| Minimum Pulse Width ² | PW | | | 1000 | ns | $C_L = 15\ \text{pF}$, CMOS signal levels |
| Maximum Data Rate ³ | | 1 | | | Mbps | $C_L = 15\ \text{pF}$, CMOS signal levels |
| Propagation Delay ⁴ | t_{PHL}, t_{PLH} | 50 | 65 | 100 | ns | $C_L = 15\ \text{pF}$, CMOS signal levels |
| Pulse Width Distortion, $ t_{PLH} - t_{PHL} ^4$ | PWD | | | 40 | ns | $C_L = 15\ \text{pF}$, CMOS signal levels |
| Propagation Delay Skew ⁵ | t_{PSK} | | | 50 | ns | $C_L = 15\ \text{pF}$, CMOS signal levels |
| Channel-to-Channel Matching ⁶ | t_{PSKCD}/t_{PSKOD} | | | 50 | ns | $C_L = 15\ \text{pF}$, CMOS signal levels |
| ADuM1300WTRWZ/ADuM1301WTRWZ | | | | | | |
| Minimum Pulse Width ² | PW | | | 100 | ns | $C_L = 15\ \text{pF}$, CMOS signal levels |
| Maximum Data Rate ³ | | 10 | | | Mbps | $C_L = 15\ \text{pF}$, CMOS signal levels |
| Propagation Delay ⁴ | t_{PHL}, t_{PLH} | 18 | 27 | 32 | ns | $C_L = 15\ \text{pF}$, CMOS signal levels |
| Pulse Width Distortion, $ t_{PLH} - t_{PHL} ^4$ | PWD | | | 3 | ns | $C_L = 15\ \text{pF}$, CMOS signal levels |
| Change vs. Temperature | | | 5 | | ps/ $^\circ\text{C}$ | $C_L = 15\ \text{pF}$, CMOS signal levels |
| Propagation Delay Skew ⁵ | t_{PSK} | | | 15 | ns | $C_L = 15\ \text{pF}$, CMOS signal levels |
| Channel-to-Channel Matching, Codirectional Channels ⁶ | t_{PSKCD} | | | 3 | ns | $C_L = 15\ \text{pF}$, CMOS signal levels |
| Channel-to-Channel Matching, Opposing-Directional Channels ⁶ | t_{PSKOD} | | | 6 | ns | $C_L = 15\ \text{pF}$, CMOS signal levels |

| Parameter | Symbol | Min | Typ | Max | Unit | Test Conditions |
|---|--------------------|-----|------|-----|-------------|---|
| For All Models | | | | | | |
| Output Disable Propagation Delay (High/Low to High Impedance) | t_{PHZ}, t_{PLH} | | 6 | 8 | ns | $C_L = 15 \text{ pF}$, CMOS signal levels |
| Output Enable Propagation Delay (High Impedance to High/Low) | t_{PZH}, t_{PZL} | | 6 | 8 | ns | $C_L = 15 \text{ pF}$, CMOS signal levels |
| Output Rise/Fall Time (10% to 90%) | t_R/t_F | | 2.5 | | ns | $C_L = 15 \text{ pF}$, CMOS signal levels |
| Common-Mode Transient Immunity at Logic High Output ⁷ | $ CM_H $ | 25 | 35 | | kV/ μ s | $V_{IX} = V_{DD1}/V_{DD2}$, $V_{CM} = 1000 \text{ V}$, transient magnitude = 800 V |
| Common-Mode Transient Immunity at Logic Low Output ⁷ | $ CM_L $ | 25 | 35 | | kV/ μ s | $V_{IX} = 0 \text{ V}$, $V_{CM} = 1000 \text{ V}$, transient magnitude = 800 V |
| Refresh Rate | f_r | | 1.2 | | Mbps | |
| Input Dynamic Supply Current per Channel ⁸ | $I_{DDI(D)}$ | | 0.19 | | mA/Mbps | |
| Output Dynamic Supply Current per Channel ⁸ | $I_{DDO(D)}$ | | 0.05 | | mA/Mbps | |

¹ The supply current values are for all three channels combined when running at identical data rates. Output supply current values are specified with no output load present. The supply current associated with an individual channel operating at a given data rate may be calculated as described in the Power Consumption section. See Figure 6 through Figure 8 for information on per-channel supply current as a function of data rate for unloaded and loaded conditions. See Figure 9 through Figure 12 for total V_{DD1} and V_{DD2} supply currents as a function of data rate for ADUM1300W/ADUM1301W channel configurations.

² The minimum pulse width is the shortest pulse width at which the specified pulse width distortion is guaranteed.

³ The maximum data rate is the fastest data rate at which the specified pulse width distortion is guaranteed.

⁴ t_{PHL} propagation delay is measured from the 50% level of the falling edge of the V_{IX} signal to the 50% level of the falling edge of the V_{OX} signal. t_{PLH} propagation delay is measured from the 50% level of the rising edge of the V_{IX} signal to the 50% level of the rising edge of the V_{OX} signal.

⁵ t_{PSK} is the magnitude of the worst-case difference in t_{PHL} or t_{PLH} that is measured between units at the same operating temperature, supply voltages, and output load within the recommended operating conditions.

⁶ Codirectional channel-to-channel matching is the absolute value of the difference in propagation delays between any two channels with inputs on the same side of the isolation barrier. Opposing-directional channel-to-channel matching is the absolute value of the difference in propagation delays between any two channels with inputs on opposing sides of the isolation barrier.

⁷ CM_H is the maximum common-mode voltage slew rate that can be sustained while maintaining $V_O > 0.8 V_{DD2}$. CM_L is the maximum common-mode voltage slew rate that can be sustained while maintaining $V_O < 0.8 \text{ V}$. The common-mode voltage slew rates apply to both rising and falling common-mode voltage edges. The transient magnitude is the range over which the common mode is slewed.

⁸ Dynamic supply current is the incremental amount of supply current required for a 1 Mbps increase in signal data rate. See Figure 6 through Figure 8 for information on per-channel supply current for unloaded and loaded conditions. See the Power Consumption section for guidance on calculating the per-channel supply current for a given data rate.

ELECTRICAL CHARACTERISTICS—3 V, 125°C OPERATION

All voltages are relative to their respective ground. $3.0\text{ V} \leq V_{DD1} \leq 3.6\text{ V}$, $3.0\text{ V} \leq V_{DD2} \leq 3.6\text{ V}$; all minimum/maximum specifications apply over the entire recommended operation range, unless otherwise noted; all typical specifications are at $T_A = 25^\circ\text{C}$, $V_{DD1} = V_{DD2} = 3.0\text{ V}$. These specifications apply to [ADuM1300W](#) and [ADuM1301W](#) automotive grade versions.

Table 5.

| Parameter | Symbol | Min | Typ | Max | Unit | Test Conditions |
|---|--|--------------------------|-------|------|---------------|--|
| DC SPECIFICATIONS | | | | | | |
| Input Supply Current per Channel, Quiescent | $I_{DD1(Q)}$ | | 0.26 | 0.31 | mA | |
| Output Supply Current per Channel, Quiescent | $I_{DDO(Q)}$ | | 0.11 | 0.15 | mA | |
| ADuM1300W, Total Supply Current, Three Channels¹ | | | | | | |
| DC to 2 Mbps | | | | | | |
| V_{DD1} Supply Current | $I_{DD1(Q)}$ | | 0.9 | 1.7 | mA | DC to 1 MHz logic signal freq. |
| V_{DD2} Supply Current | $I_{DD2(Q)}$ | | 0.4 | 0.7 | mA | DC to 1 MHz logic signal freq. |
| 10 Mbps (TRWZ Grade Only) | | | | | | |
| V_{DD1} Supply Current | $I_{DD1(10)}$ | | 3.4 | 4.9 | mA | 5 MHz logic signal freq. |
| V_{DD2} Supply Current | $I_{DD2(10)}$ | | 1.1 | 1.6 | mA | 5 MHz logic signal freq. |
| ADuM1301W, Total Supply Current, Three Channels¹ | | | | | | |
| DC to 2 Mbps | | | | | | |
| V_{DD1} Supply Current | $I_{DD1(Q)}$ | | 0.7 | 1.4 | mA | DC to 1 MHz logic signal freq. |
| V_{DD2} Supply Current | $I_{DD2(Q)}$ | | 0.6 | 0.9 | mA | DC to 1 MHz logic signal freq. |
| 10 Mbps (TRWZ Grade Only) | | | | | | |
| V_{DD1} Supply Current | $I_{DD1(10)}$ | | 2.6 | 3.7 | mA | 5 MHz logic signal freq. |
| V_{DD2} Supply Current | $I_{DD2(10)}$ | | 1.8 | 2.5 | mA | 5 MHz logic signal freq. |
| For All Models | | | | | | |
| Input Currents | $I_{IA}, I_{IB}, I_{IC}, I_{E1}, I_{E2}$ | -10 | +0.01 | +10 | μA | $0\text{ V} \leq V_{IA}, V_{IB}, V_{IC} \leq V_{DD1}$ or V_{DD2} , $0\text{ V} \leq V_{E1}, V_{E2} \leq V_{DD1}$ or V_{DD2} |
| Logic High Input Threshold | V_{IH}, V_{EH} | 1.6 | | | V | |
| Logic Low Input Threshold | V_{IL}, V_{EL} | | | 0.4 | V | |
| Logic High Output Voltages | $V_{OAH}, V_{OBH}, V_{OCH}$ | $V_{DD1}, V_{DD2} - 0.1$ | 3.0 | | V | $I_{OX} = -20\ \mu\text{A}, V_{IX} = V_{IXH}$ |
| | | $V_{DD1}, V_{DD2} - 0.4$ | 2.8 | | V | $I_{OX} = -4\ \mu\text{A}, V_{IX} = V_{IXH}$ |
| Logic Low Output Voltages | $V_{OAL}, V_{OBL}, V_{OCL}$ | | 0.0 | 0.1 | V | $I_{OX} = 20\ \mu\text{A}, V_{IX} = V_{IXL}$ |
| | | | 0.04 | 0.1 | V | $I_{OX} = 400\ \mu\text{A}, V_{IX} = V_{IXL}$ |
| | | | 0.2 | 0.4 | V | $I_{OX} = 4\ \text{mA}, V_{IX} = V_{IXL}$ |
| SWITCHING SPECIFICATIONS | | | | | | |
| ADuM1300WSRWZ/ADuM1301WSRWZ | | | | | | |
| Minimum Pulse Width ² | PW | | | 1000 | ns | $C_L = 15\ \text{pF}$, CMOS signal levels |
| Maximum Data Rate ³ | | 1 | | | Mbps | $C_L = 15\ \text{pF}$, CMOS signal levels |
| Propagation Delay ⁴ | t_{PHL}, t_{PLH} | 50 | 75 | 100 | ns | $C_L = 15\ \text{pF}$, CMOS signal levels |
| Pulse Width Distortion, $ t_{PLH} - t_{PHL} ^4$ | PWD | | | 40 | ns | $C_L = 15\ \text{pF}$, CMOS signal levels |
| Propagation Delay Skew ⁵ | t_{PSK} | | | 50 | ns | $C_L = 15\ \text{pF}$, CMOS signal levels |
| Channel-to-Channel Matching ⁶ | t_{PSKCD}/t_{PSKOD} | | | 50 | ns | $C_L = 15\ \text{pF}$, CMOS signal levels |
| ADuM1300WTRWZ/ADuM1301WTRWZ | | | | | | |
| Minimum Pulse Width ² | PW | | | 100 | ns | $C_L = 15\ \text{pF}$, CMOS signal levels |
| Maximum Data Rate ³ | | 10 | | | Mbps | $C_L = 15\ \text{pF}$, CMOS signal levels |
| Propagation Delay ⁴ | t_{PHL}, t_{PLH} | 20 | 34 | 45 | ns | $C_L = 15\ \text{pF}$, CMOS signal levels |
| Pulse Width Distortion, $ t_{PLH} - t_{PHL} ^4$ | PWD | | | 3 | ns | $C_L = 15\ \text{pF}$, CMOS signal levels |
| Change vs. Temperature | | | 5 | | ps/°C | $C_L = 15\ \text{pF}$, CMOS signal levels |
| Propagation Delay Skew ⁵ | t_{PSK} | | | 26 | ns | $C_L = 15\ \text{pF}$, CMOS signal levels |
| Channel-to-Channel Matching, Codirectional Channels ⁶ | t_{PSKCD} | | | 3 | ns | $C_L = 15\ \text{pF}$, CMOS signal levels |
| Channel-to-Channel Matching, Opposing-Directional Channels ⁶ | t_{PSKOD} | | | 6 | ns | $C_L = 15\ \text{pF}$, CMOS signal levels |

| Parameter | Symbol | Min | Typ | Max | Unit | Test Conditions |
|--|--------------------|-----|------|-----|-------------|--|
| For All Models | | | | | | |
| Output Disable Propagation Delay (High/Low to High Impedance) | t_{PHZ}, t_{PLH} | | 6 | 8 | ns | $C_L = 15 \text{ pF}$, CMOS signal levels |
| Output Enable Propagation Delay (High Impedance to High/Low) | t_{PZH}, t_{PZL} | | 6 | 8 | ns | $C_L = 15 \text{ pF}$, CMOS signal levels |
| Output Rise/Fall Time (10% to 90%) | t_R/t_F | | 3 | | ns | $C_L = 15 \text{ pF}$, CMOS signal levels |
| Common-Mode Transient Immunity at Logic High Output ⁷ | $ CM_H $ | 25 | 35 | | kV/ μ s | $V_{ix} = V_{DD1}/V_{DD2}$, $V_{CM} = 1000 \text{ V}$, transient magnitude = 800 V |
| Common-Mode Transient Immunity at Logic Low Output ⁷ | $ CM_L $ | 25 | 35 | | kV/ μ s | $V_{ix} = 0 \text{ V}$, $V_{CM} = 1000 \text{ V}$, transient magnitude = 800 V |
| Refresh Rate | f_r | | 1.1 | | Mbps | |
| Input Dynamic Supply Current per Channel ⁸ | $I_{DDI(D)}$ | | 0.10 | | mA/Mbps | |
| Output Dynamic Supply Current per Channel ⁸ | $I_{DDO(D)}$ | | 0.03 | | mA/Mbps | |

¹ The supply current values are for all three channels combined when running at identical data rates. Output supply current values are specified with no output load present. The supply current associated with an individual channel operating at a given data rate may be calculated as described in the Power Consumption section. See Figure 6 through Figure 8 for information on per-channel supply current as a function of data rate for unloaded and loaded conditions. See Figure 9 through Figure 12 for total V_{DD1} and V_{DD2} supply currents as a function of data rate for ADUM1300W/ADUM1301W channel configurations.

² The minimum pulse width is the shortest pulse width at which the specified pulse width distortion is guaranteed.

³ The maximum data rate is the fastest data rate at which the specified pulse width distortion is guaranteed.

⁴ t_{PHL} propagation delay is measured from the 50% level of the falling edge of the V_{ix} signal to the 50% level of the falling edge of the V_{ox} signal. t_{PLH} propagation delay is measured from the 50% level of the rising edge of the V_{ix} signal to the 50% level of the rising edge of the V_{ox} signal.

⁵ t_{PSK} is the magnitude of the worst-case difference in t_{PHL} or t_{PLH} that is measured between units at the same operating temperature, supply voltages, and output load within the recommended operating conditions.

⁶ Codirectional channel-to-channel matching is the absolute value of the difference in propagation delays between any two channels with inputs on the same side of the isolation barrier. Opposing-directional channel-to-channel matching is the absolute value of the difference in propagation delays between any two channels with inputs on opposing sides of the isolation barrier.

⁷ CM_H is the maximum common-mode voltage slew rate that can be sustained while maintaining $V_O > 0.8 V_{DD2}$. CM_L is the maximum common-mode voltage slew rate that can be sustained while maintaining $V_O < 0.8 \text{ V}$. The common-mode voltage slew rates apply to both rising and falling common-mode voltage edges. The transient magnitude is the range over which the common mode is slewed.

⁸ Dynamic supply current is the incremental amount of supply current required for a 1 Mbps increase in signal data rate. See Figure 6 through Figure 8 for information on per-channel supply current for unloaded and loaded conditions. See the Power Consumption section for guidance on calculating the per-channel supply current for a given data rate.

ELECTRICAL CHARACTERISTICS—MIXED 5 V/3 V, 125°C OPERATION¹

All voltages are relative to their respective ground. $4.5\text{ V} \leq V_{DD1} \leq 5.5\text{ V}$, $3.0\text{ V} \leq V_{DD2} \leq 3.6\text{ V}$; all minimum/maximum specifications apply over the entire recommended operation range, unless otherwise noted; all typical specifications are at $T_A = 25^\circ\text{C}$; $V_{DD1} = 5\text{ V}$, $V_{DD2} = 3.0\text{ V}$. These specifications apply to [ADuM1300W](#) and [ADuM1301W](#) automotive grade versions.

Table 6.

| Parameter | Symbol | Min | Typ | Max | Unit | Test Conditions |
|---|--|--|--|-------------------|---------------|--|
| DC SPECIFICATIONS | | | | | | |
| Input Supply Current per Channel, Quiescent | $I_{DD1(Q)}$ | | 0.50 | 0.53 | mA | |
| Output Supply Current per Channel, Quiescent | $I_{DD0(Q)}$ | | 0.11 | 0.15 | mA | |
| ADuM1300W , Total Supply Current, Three Channels ² | | | | | | |
| DC to 2 Mbps | | | | | | |
| V_{DD1} Supply Current | $I_{DD1(Q)}$ | | 1.6 | 2.5 | mA | DC to 1 MHz logic signal freq. |
| V_{DD2} Supply Current | $I_{DD2(Q)}$ | | 0.4 | 0.7 | mA | DC to 1 MHz logic signal freq. |
| 10 Mbps (TRWZ Grade Only) | | | | | | |
| V_{DD1} Supply Current | $I_{DD1(10)}$ | | 6.5 | 8.1 | mA | 5 MHz logic signal freq. |
| V_{DD2} Supply Current | $I_{DD2(10)}$ | | 1.1 | 1.6 | mA | 5 MHz logic signal freq. |
| ADuM1301W , Total Supply Current, Three Channels ¹ | | | | | | |
| DC to 2 Mbps | | | | | | |
| V_{DD1} Supply Current | $I_{DD1(Q)}$ | | 1.3 | 2.1 | mA | DC to 1 MHz logic signal freq. |
| V_{DD2} Supply Current | $I_{DD2(Q)}$ | | 0.6 | 0.9 | mA | DC to 1 MHz logic signal freq. |
| 10 Mbps (TRWZ Grade Only) | | | | | | |
| V_{DD1} Supply Current | $I_{DD1(10)}$ | | 5.0 | 6.2 | mA | 5 MHz logic signal freq. |
| V_{DD2} Supply Current | $I_{DD2(10)}$ | | 1.8 | 2.5 | mA | 5 MHz logic signal freq. |
| For All Models | | | | | | |
| Input Currents | $I_{IA}, I_{IB}, I_{IC}, I_{E1}, I_{E2}$ | -10 | +0.01 | +10 | μA | $0\text{ V} \leq V_{IA}, V_{IB}, V_{IC} \leq V_{DD1}$ or V_{DD2} , $0\text{ V} \leq V_{E1}, V_{E2} \leq V_{DD1}$ or V_{DD2} |
| Logic High Input Threshold | V_{IH}, V_{EH} | 2.0 | | | V | |
| Logic Low Input Threshold | V_{IL}, V_{EL} | | | 0.8 | V | |
| Logic High Output Voltages | $V_{OAH}, V_{OBH}, V_{OCH}$ | $V_{DD1}, V_{DD2} - 0.1$ $V_{DD1}, V_{DD2} - 0.4$ | V_{DD1}, V_{DD2} $V_{DD1}, V_{DD2} - 0.2$ | | V | $I_{OX} = -20\ \mu\text{A}, V_{IX} = V_{IXH}$ $I_{OX} = -4\ \text{mA}, V_{IX} = V_{IXH}$ |
| Logic Low Output Voltages | $V_{OAL}, V_{OBL}, V_{OCL}$ | | 0.0 0.04 0.2 | 0.1 0.1 0.4 | V | $I_{OX} = 20\ \mu\text{A}, V_{IX} = V_{IXL}$ $I_{OX} = 400\ \mu\text{A}, V_{IX} = V_{IXL}$ $I_{OX} = 4\ \text{mA}, V_{IX} = V_{IXL}$ |
| SWITCHING SPECIFICATIONS | | | | | | |
| ADuM1300WSRWZ/ADuM1301WSRWZ | | | | | | |
| Minimum Pulse Width ³ | PW | | | 1000 | ns | $C_L = 15\ \text{pF}$, CMOS signal levels |
| Maximum Data Rate ⁴ | | 1 | | | Mbps | $C_L = 15\ \text{pF}$, CMOS signal levels |
| Propagation Delay ⁵ | t_{PHL}, t_{PLH} | 50 | 70 | 100 | ns | $C_L = 15\ \text{pF}$, CMOS signal levels |
| Pulse Width Distortion, $ t_{PLH} - t_{PHL} ^4$ | PWD | | | 40 | ns | $C_L = 15\ \text{pF}$, CMOS signal levels |
| Propagation Delay Skew ⁶ | t_{PSK} | | | 50 | ns | $C_L = 15\ \text{pF}$, CMOS signal levels |
| Channel-to-Channel Matching ⁷ | t_{PSKCD}/t_{PSKOD} | | | 50 | ns | $C_L = 15\ \text{pF}$, CMOS signal levels |
| ADuM1300WTRWZ/ADuM1301WTRWZ | | | | | | |
| Minimum Pulse Width ² | PW | | | 100 | ns | $C_L = 15\ \text{pF}$, CMOS signal levels |
| Maximum Data Rate ³ | | 10 | | | Mbps | $C_L = 15\ \text{pF}$, CMOS signal levels |
| Propagation Delay ⁴ | t_{PHL}, t_{PLH} | 20 | 30 | 40 | ns | $C_L = 15\ \text{pF}$, CMOS signal levels |
| Pulse Width Distortion, $ t_{PLH} - t_{PHL} ^4$ | PWD | | | 3 | ns | $C_L = 15\ \text{pF}$, CMOS signal levels |
| Change vs. Temperature | | | 5 | | ps/°C | $C_L = 15\ \text{pF}$, CMOS signal levels |
| Propagation Delay Skew ⁵ | t_{PSK} | | | 6 | ns | $C_L = 15\ \text{pF}$, CMOS signal levels |
| Channel-to-Channel Matching, Codirectional Channels ⁶ | t_{PSKCD} | | | 3 | ns | $C_L = 15\ \text{pF}$, CMOS signal levels |
| Channel-to-Channel Matching, Opposing-Directional Channels ⁶ | t_{PSKOD} | | | 22 | ns | $C_L = 15\ \text{pF}$, CMOS signal levels |

| Parameter | Symbol | Min | Typ | Max | Unit | Test Conditions |
|--|--------------------|-----|------|-----|-------------|---|
| For All Models | | | | | | |
| Output Disable Propagation Delay (High/Low to High Impedance) | t_{PHZ}, t_{PLH} | | 6 | 8 | ns | $C_L = 15$ pF, CMOS signal levels |
| Output Enable Propagation Delay (High Impedance to High/Low) | t_{PZH}, t_{PZL} | | 6 | 8 | ns | $C_L = 15$ pF, CMOS signal levels |
| Output Rise/Fall Time (10% to 90%) | t_R/t_F | | 3.0 | | ns | $C_L = 15$ pF, CMOS signal levels |
| Common-Mode Transient Immunity at Logic High Output ⁸ | $ CM_H $ | 25 | 35 | | kV/ μ s | $V_{IX} = V_{DD1}/V_{DD2}$, $V_{CM} = 1000$ V, transient magnitude = 800 V |
| Common-Mode Transient Immunity at Logic Low Output ⁷ | $ CM_L $ | 25 | 35 | | kV/ μ s | $V_{IX} = 0$ V, $V_{CM} = 1000$ V, transient magnitude = 800 V |
| Refresh Rate | f_r | | 1.2 | | Mbps | |
| Input Dynamic Supply Current per Channel ⁹ | $I_{DDI(D)}$ | | 0.19 | | mA/Mbps | |
| Output Dynamic Supply Current per Channel ⁸ | $I_{DDO(D)}$ | | 0.03 | | mA/Mbps | |

¹ All voltages are relative to their respective ground.

² The supply current values are for all three channels combined when running at identical data rates. Output supply current values are specified with no output load present. The supply current associated with an individual channel operating at a given data rate may be calculated as described in the Power Consumption section. See Figure 6 through Figure 8 for information on per-channel supply current as a function of data rate for unloaded and loaded conditions. See Figure 9 through Figure 12 for total V_{DD1} and V_{DD2} supply currents as a function of data rate for ADUM1300W/ADUM1301W channel configurations.

³ The minimum pulse width is the shortest pulse width at which the specified pulse width distortion is guaranteed.

⁴ The maximum data rate is the fastest data rate at which the specified pulse width distortion is guaranteed.

⁵ t_{PHL} propagation delay is measured from the 50% level of the falling edge of the V_{IX} signal to the 50% level of the falling edge of the V_{OX} signal. t_{PLH} propagation delay is measured from the 50% level of the rising edge of the V_{IX} signal to the 50% level of the rising edge of the V_{OX} signal.

⁶ t_{PSK} is the magnitude of the worst-case difference in t_{PHL} or t_{PLH} that is measured between units at the same operating temperature, supply voltages, and output load within the recommended operating conditions.

⁷ Codirectional channel-to-channel matching is the absolute value of the difference in propagation delays between any two channels with inputs on the same side of the isolation barrier. Opposing-directional channel-to-channel matching is the absolute value of the difference in propagation delays between any two channels with inputs on opposing sides of the isolation barrier.

⁸ CM_H is the maximum common-mode voltage slew rate that can be sustained while maintaining $V_O > 0.8 V_{DD2}$. CM_L is the maximum common-mode voltage slew rate that can be sustained while maintaining $V_O < 0.8 V$. The common-mode voltage slew rates apply to both rising and falling common-mode voltage edges. The transient magnitude is the range over which the common mode is slewed.

⁹ Dynamic supply current is the incremental amount of supply current required for a 1 Mbps increase in signal data rate. See Figure 6 through Figure 8 for information on per-channel supply current for unloaded and loaded conditions. See the Power Consumption section for guidance on calculating the per-channel supply current for a given data rate.

ELECTRICAL CHARACTERISTICS—MIXED 3 V/5 V, 125°C OPERATION

All voltages are relative to their respective ground. $3.0\text{ V} \leq V_{DD1} \leq 3.6\text{ V}$, $4.5\text{ V} \leq V_{DD2} \leq 5.5\text{ V}$; all minimum/maximum specifications apply over the entire recommended operation range, unless otherwise noted; all typical specifications are at $T_A = 25^\circ\text{C}$; $V_{DD1} = 3.0\text{ V}$, $V_{DD2} = 5\text{ V}$. These apply to [ADuM1300W](#) and [ADuM1301W](#) automotive grade versions.

Table 7.

| Parameter | Symbol | Min | Typ | Max | Unit | Test Conditions |
|---|--|--------------------------|--------------------------|------|---------------|--|
| DC SPECIFICATIONS | | | | | | |
| Input Supply Current per Channel, Quiescent | $I_{DD1(Q)}$ | | 0.26 | 0.31 | mA | |
| Output Supply Current per Channel, Quiescent | $I_{DD0(Q)}$ | | 0.19 | 0.24 | mA | |
| ADuM1300W , Total Supply Current, Three Channels ¹ | | | | | | |
| DC to 2 Mbps | | | | | | |
| V_{DD1} Supply Current | $I_{DD1(Q)}$ | | 0.9 | 1.7 | mA | DC to 1 MHz logic signal freq. |
| V_{DD2} Supply Current | $I_{DD2(Q)}$ | | 0.7 | 1.0 | mA | DC to 1 MHz logic signal freq. |
| 10 Mbps (TRWZ Grade Only) | | | | | | |
| V_{DD1} Supply Current | $I_{DD1(10)}$ | | 3.4 | 4.9 | mA | 5 MHz logic signal freq. |
| V_{DD2} Supply Current | $I_{DD2(10)}$ | | 1.9 | 2.5 | mA | 5 MHz logic signal freq. |
| ADuM1301W , Total Supply Current, Three Channels ¹ | | | | | | |
| DC to 2 Mbps | | | | | | |
| V_{DD1} Supply Current | $I_{DD1(Q)}$ | | 0.7 | 1.4 | mA | DC to 1 MHz logic signal freq. |
| V_{DD2} Supply Current | $I_{DD2(Q)}$ | | 1.0 | 1.4 | mA | DC to 1 MHz logic signal freq. |
| 10 Mbps (TRWZ Grade Only) | | | | | | |
| V_{DD1} Supply Current | $I_{DD1(10)}$ | | 2.6 | 3.7 | mA | 5 MHz logic signal freq. |
| V_{DD2} Supply Current | $I_{DD2(10)}$ | | 3.4 | 4.2 | mA | 5 MHz logic signal freq. |
| For All Models | | | | | | |
| Input Currents | $I_{IA}, I_{IB}, I_{IC}, I_{E1}, I_{E2}$ | -10 | +0.01 | +10 | μA | $0\text{ V} \leq V_{IA}, V_{IB}, V_{IC} \leq V_{DD1}$ or V_{DD2} , $0\text{ V} \leq V_{E1}, V_{E2} \leq V_{DD1}$ or V_{DD2} |
| Logic High Input Threshold | V_{IH}, V_{EH} | 1.6 | | | V | |
| Logic Low Input Threshold | V_{IL}, V_{EL} | | | 0.4 | V | |
| Logic High Output Voltages | $V_{OAH}, V_{OBH}, V_{OCH}$ | $V_{DD1}, V_{DD2} - 0.1$ | V_{DD1}, V_{DD2} | | V | $I_{OX} = -20\ \mu\text{A}$, $V_{IX} = V_{IXH}$ |
| | | $V_{DD1}, V_{DD2} - 0.4$ | $V_{DD1}, V_{DD2} - 0.2$ | | V | $I_{OX} = -4\ \text{mA}$, $V_{IX} = V_{IXH}$ |
| Logic Low Output Voltages | $V_{OAL}, V_{OBL}, V_{OCL}$ | | 0.0 | 0.1 | V | $I_{OX} = 20\ \mu\text{A}$, $V_{IX} = V_{IXL}$ |
| | | | 0.04 | 0.1 | V | $I_{OX} = 400\ \mu\text{A}$, $V_{IX} = V_{IXL}$ |
| | | | 0.2 | 0.4 | V | $I_{OX} = 4\ \text{mA}$, $V_{IX} = V_{IXL}$ |
| SWITCHING SPECIFICATIONS | | | | | | |
| ADuM1300WSRWZ/ADuM1301WSRWZ | | | | | | |
| Minimum Pulse Width ² | PW | | | 1000 | ns | $C_L = 15\ \text{pF}$, CMOS signal levels |
| Maximum Data Rate ³ | | 1 | | | Mbps | $C_L = 15\ \text{pF}$, CMOS signal levels |
| Propagation Delay ⁴ | t_{PHL}, t_{PLH} | 50 | 70 | 100 | ns | $C_L = 15\ \text{pF}$, CMOS signal levels |
| Pulse Width Distortion, $ t_{PLH} - t_{PHL} ^4$ | PWD | | | 40 | ns | $C_L = 15\ \text{pF}$, CMOS signal levels |
| Propagation Delay Skew ⁵ | t_{PSK} | | | 50 | ns | $C_L = 15\ \text{pF}$, CMOS signal levels |
| Channel-to-Channel Matching ⁶ | t_{PSKCD}/t_{PSKOD} | | | 50 | ns | $C_L = 15\ \text{pF}$, CMOS signal levels |
| ADuM1300WTRWZ/ADuM1301WTRWZ | | | | | | |
| Minimum Pulse Width ² | PW | | | 100 | ns | $C_L = 15\ \text{pF}$, CMOS signal levels |
| Maximum Data Rate ³ | | 10 | | | Mbps | $C_L = 15\ \text{pF}$, CMOS signal levels |
| Propagation Delay ⁴ | t_{PHL}, t_{PLH} | 20 | 30 | 40 | ns | $C_L = 15\ \text{pF}$, CMOS signal levels |
| Pulse Width Distortion, $ t_{PLH} - t_{PHL} ^4$ | PWD | | | 3 | ns | $C_L = 15\ \text{pF}$, CMOS signal levels |
| Change vs. Temperature | | | 5 | | ps/°C | $C_L = 15\ \text{pF}$, CMOS signal levels |
| Propagation Delay Skew ⁵ | t_{PSK} | | | 6 | ns | $C_L = 15\ \text{pF}$, CMOS signal levels |
| Channel-to-Channel Matching, Codirectional Channels ⁶ | t_{PSKCD} | | | 3 | ns | $C_L = 15\ \text{pF}$, CMOS signal levels |
| Channel-to-Channel Matching, Opposing-Directional Channels ⁶ | t_{PSKOD} | | | 22 | ns | $C_L = 15\ \text{pF}$, CMOS signal levels |

| Parameter | Symbol | Min | Typ | Max | Unit | Test Conditions |
|--|--------------------|-----|------|-----|-------------------|--|
| For All Models | | | | | | |
| Output Disable Propagation Delay (High/Low to High Impedance) | t_{PHZ}, t_{PLH} | | 6 | 8 | ns | $C_L = 15 \text{ pF}$, CMOS signal levels |
| Output Enable Propagation Delay (High Impedance to High/Low) | t_{PZH}, t_{PZL} | | 6 | 8 | ns | $C_L = 15 \text{ pF}$, CMOS signal levels |
| Output Rise/Fall Time (10% to 90%) | t_R/t_F | | | | | $C_L = 15 \text{ pF}$, CMOS signal levels |
| 5 V/3 V Operation | | | 3.0 | | ns | |
| 3 V/5 V Operation | | | 2.5 | | ns | |
| Common-Mode Transient Immunity at Logic High Output ⁷ | $ CM_H $ | 25 | 35 | | kV/ μs | $V_{IX} = V_{DD1}/V_{DD2}$, $V_{CM} = 1000 \text{ V}$, transient magnitude = 800 V |
| Common-Mode Transient Immunity at Logic Low Output ⁷ | $ CM_L $ | 25 | 35 | | kV/ μs | $V_{IX} = 0 \text{ V}$, $V_{CM} = 1000 \text{ V}$, transient magnitude = 800 V |
| Refresh Rate | f_r | | 1.1 | | Mbps | |
| Input Dynamic Supply Current per Channel ⁸ | $I_{DDI(D)}$ | | 0.10 | | mA/Mbps | |
| Output Dynamic Supply Current per Channel ⁸ | $I_{DDO(D)}$ | | 0.05 | | mA/Mbps | |

¹ The supply current values are for all three channels combined when running at identical data rates. Output supply current values are specified with no output load present. The supply current associated with an individual channel operating at a given data rate may be calculated as described in the Power Consumption section. See Figure 6 through Figure 8 for information on per-channel supply current as a function of data rate for unloaded and loaded conditions. See Figure 9 through Figure 12 for total V_{DD1} and V_{DD2} supply currents as a function of data rate for ADuM1300W/ADuM1301W channel configurations.

² The minimum pulse width is the shortest pulse width at which the specified pulse width distortion is guaranteed.

³ The maximum data rate is the fastest data rate at which the specified pulse width distortion is guaranteed.

⁴ t_{PHL} propagation delay is measured from the 50% level of the falling edge of the V_{IX} signal to the 50% level of the falling edge of the V_{OX} signal. t_{PLH} propagation delay is measured from the 50% level of the rising edge of the V_{IX} signal to the 50% level of the rising edge of the V_{OX} signal.

⁵ t_{PSK} is the magnitude of the worst-case difference in t_{PHL} or t_{PLH} that is measured between units at the same operating temperature, supply voltages, and output load within the recommended operating conditions.

⁶ Codirectional channel-to-channel matching is the absolute value of the difference in propagation delays between any two channels with inputs on the same side of the isolation barrier. Opposing-directional channel-to-channel matching is the absolute value of the difference in propagation delays between any two channels with inputs on opposing sides of the isolation barrier.

⁷ CM_H is the maximum common-mode voltage slew rate that can be sustained while maintaining $V_O > 0.8 V_{DD2}$. CM_L is the maximum common-mode voltage slew rate that can be sustained while maintaining $V_O < 0.8 \text{ V}$. The common-mode voltage slew rates apply to both rising and falling common-mode voltage edges. The transient magnitude is the range over which the common mode is slewed.

⁸ Dynamic supply current is the incremental amount of supply current required for a 1 Mbps increase in signal data rate. See Figure 6 through Figure 8 for information on per-channel supply current for unloaded and loaded conditions. See the Power Consumption section for guidance on calculating the per-channel supply current for a given data rate.

PACKAGE CHARACTERISTICS

Table 8.

| Parameter | Symbol | Min | Typ | Max | Unit | Test Conditions |
|--|------------------|-----|------------------|-----|------|---|
| Resistance (Input-to-Output) ¹ | R _{I-O} | | 10 ¹² | | Ω | |
| Capacitance (Input-to-Output) ¹ | C _{I-O} | | 1.7 | | pF | f = 1 MHz |
| Input Capacitance ² | C _I | | 4.0 | | pF | |
| IC Junction-to-Case Thermal Resistance, Side 1 | θ _{JCI} | | 33 | | °C/W | Thermocouple located at center of package underside |
| IC Junction-to-Case Thermal Resistance, Side 2 | θ _{JCO} | | 28 | | °C/W | |

¹ Device is considered a 2-terminal device; Pin 1, Pin 2, Pin 3, Pin 4, Pin 5, Pin 6, Pin 7, and Pin 8 are shorted together and Pin 9, Pin 10, Pin 11, Pin 12, Pin 13, Pin 14, Pin 15, and Pin 16 are shorted together.

² Input capacitance is from any input data pin to ground.

REGULATORY INFORMATION

The ADuM1300/ADuM1301 are approved by the organizations listed in Table 9. Refer to Table 14 and the Insulation Lifetime section for details regarding recommended maximum working voltages for specific crossisolation waveforms and insulation levels.

Table 9.

| UL | CSA | CQC | VDE | TÜV |
|--|--|---|---|---|
| Recognized Under 1577 Component Recognition Program ¹ | Approved under CSA Component Acceptance Notice 5A | Approved under CQC11-471543-2012 | Certified according to DIN V VDE V 0884-10 (VDE V 0884-10):2006-12 ² | Approved according to IEC 61010-1:2001 (2 nd Edition), EN 61010-1:2001 (2 nd Edition), UL 61010-1:2004 CSA C22.2.61010.1:2005 |
| Single Protection, 2500 V rms Isolation Voltage | Basic insulation per CSA 60950-1-03 and IEC 60950-1, 800 V rms (1131 V peak) maximum working voltage Reinforced insulation per CSA 60950-1-03 and IEC 60950-1, 400 V rms (566 V peak) maximum working voltage | Basic insulation per GB4943.1-2011 Basic insulation, 415 V rms (588 V peak) maximum working voltage, tropical climate, altitude ≤ 5000 m | Reinforced insulation, 560 V peak | Reinforced insulation, 400 V rms maximum working voltage |
| File E214100 | File 205078 | File: CQC14001114900 | File 2471900-4880-0001 | Certificate U8V 05 06 56232 002 |

¹ In accordance with UL 1577, each ADuM1300/ADuM1301 is proof tested by applying an insulation test voltage ≥3000 V rms for 1 sec (current leakage detection limit = 5 μA).

² In accordance with DIN V VDE V 0884-10, each ADuM1300/ADuM1301 is proof tested by applying an insulation test voltage ≥1050 V peak for 1 sec (partial discharge detection limit = 5 pC). The * marking branded on the component designates DIN V VDE V 0884-10 approval.

INSULATION AND SAFETY-RELATED SPECIFICATIONS

Table 10.

| Parameter | Symbol | Value | Unit | Conditions |
|--|--------|-----------|-------|--|
| Rated Dielectric Insulation Voltage | | 2500 | V rms | 1-minute duration |
| Minimum External Air Gap (Clearance) | L(I01) | 7.7 min | mm | Measured from input terminals to output terminals, shortest distance through air |
| Minimum External Tracking (Creepage) | L(I02) | 8.1 min | mm | Measured from input terminals to output terminals, shortest distance path along body |
| Minimum Internal Gap (Internal Clearance) | | 0.017 min | mm | Insulation distance through insulation |
| Tracking Resistance (Comparative Tracking Index) Isolation Group | CTI | >400 | V | DIN IEC 112/VDE 0303 Part 1 Material Group (DIN VDE 0110, 1/89, Table 1) |

DIN V VDE V 0884-10 (VDE V 0884-10):2006-12 INSULATION CHARACTERISTICS

These isolators are suitable for reinforced electrical isolation only within the safety limit data. Maintenance of the safety data is ensured by protective circuits. The asterisk (*) marking on packages denotes DIN V VDE V 0884-10 approval for 560 V peak working voltage.

Table 11.

| Description | Conditions | Symbol | Characteristic | Unit |
|---|--|-------------------|--------------------------------|------------------|
| Installation Classification per DIN VDE 0110 For Rated Mains Voltage ≤ 150 V rms For Rated Mains Voltage ≤ 300 V rms For Rated Mains Voltage ≤ 400 V rms | | | I to IV I to III I to II | |
| Climatic Classification | | | 40/105/21 | |
| Pollution Degree per DIN VDE 0110, Table 1 | | | 2 | |
| Maximum Working Insulation Voltage | | V _{IORM} | 560 | V peak |
| Input-to-Output Test Voltage, Method B1 | V _{IORM} × 1.875 = V _{PR} , 100% production test, t _m = 1 sec, partial discharge < 5 pC | V _{PR} | 1050 | V peak |
| Input-to-Output Test Voltage, Method A After Environmental Tests Subgroup 1 After Input and/or Safety Test Subgroup 2 and Subgroup 3 | V _{IORM} × 1.6 = V _{PR} , t _m = 60 sec, partial discharge < 5 pC V _{IORM} × 1.2 = V _{PR} , t _m = 60 sec, partial discharge < 5 pC | V _{PR} | 896 672 | V peak V peak |
| Highest Allowable Overvoltage Safety-Limiting Values | Transient overvoltage, t _{TR} = 10 seconds Maximum value allowed in the event of a failure (see Figure 3) | V _{TR} | 4000 | V peak |
| Case Temperature | | T _S | 150 | °C |
| Side 1 Current | | I _{S1} | 265 | mA |
| Side 2 Current | | I _{S2} | 335 | mA |
| Insulation Resistance at T _S | V _{IO} = 500 V | R _S | >10 ⁹ | Ω |

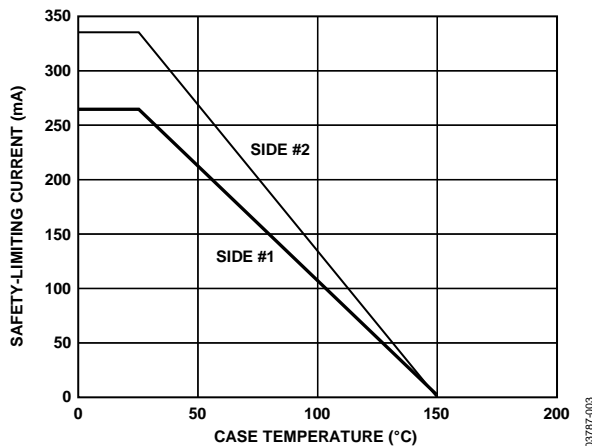

Figure 3. Thermal Derating Curve, Dependence of Safety-Limiting Values with Case Temperature per DIN V VDE V 0884-10

RECOMMENDED OPERATING CONDITIONS

Table 12.

| Parameter | Rating |
|--|-----------------|
| Operating Temperature (T _A) ¹ | -40°C to +105°C |
| Operating Temperature (T _A) ² | -40°C to +125°C |
| Supply Voltages (V _{DD1} , V _{DD2}) ^{1, 3} | 2.7 V to 5.5 V |
| Supply Voltages (V _{DD1} , V _{DD2}) ^{2, 3} | 3.0 V to 5.5 V |
| Input Signal Rise and Fall Times | 1.0 ms |

¹ Does not apply to ADuM1300W and ADuM1301W automotive grade versions.
² Applies to ADuM1300W and ADuM1301W automotive grade versions.
³ All voltages are relative to their respective ground. See the DC Correctness and Magnetic Field Immunity section for information on immunity to external magnetic fields.

ABSOLUTE MAXIMUM RATINGS

Ambient temperature = 25°C, unless otherwise noted.

Table 13.

| Parameter | Rating |
|---|------------------------------------|
| Storage Temperature (T _{ST}) | –65°C to +150°C |
| Ambient Operating Temperature (T _A) ¹ | –40°C to +105°C |
| Ambient Operating Temperature (T _A) ² | –40°C to +125°C |
| Supply Voltages (V _{DD1} , V _{DD2}) ³ | –0.5 V to +7.0 V |
| Input Voltage (V _{IA} , V _{IB} , V _{IC} , V _{E1} , V _{E2}) ^{3,4} | –0.5 V to V _{DD1} + 0.5 V |
| Output Voltage (V _{OA} , V _{OB} , V _{OC}) ^{3,4} | –0.5 V to V _{DD0} + 0.5 V |
| Average Output Current per Pin ⁵ | |
| Side 1 (I _{O1}) | –23 mA to +23 mA |
| Side 2 (I _{O2}) | –30 mA to +30 mA |
| Common-Mode Transients ⁶ | –100 kV/μs to +100 kV/μs |

¹ Does not apply to ADuM1300W and ADuM1301W automotive grade versions.

² Applies to ADuM1300W and ADuM1301W automotive grade versions.

³ All voltages are relative to their respective ground.

⁴ V_{DD1} and V_{DD0} refer to the supply voltages on the input and output sides of a given channel, respectively. See the Printed Circuit Board (PCB) Layout section.

⁵ See Figure 3 for maximum rated current values for various temperatures.

⁶ This refers to common-mode transients across the insulation barrier.

Common-mode transients exceeding the Absolute Maximum Ratings may cause latch-up or permanent damage.

Stresses at or above those listed under Absolute Maximum Ratings may cause permanent damage to the product. This is a stress rating only; functional operation of the product at these or any other conditions above those indicated in the operational section of this specification is not implied. Operation beyond the maximum operating conditions for extended periods may affect product reliability.

ESD CAUTION



ESD (electrostatic discharge) sensitive device. Charged devices and circuit boards can discharge without detection. Although this product features patented or proprietary protection circuitry, damage may occur on devices subjected to high energy ESD. Therefore, proper ESD precautions should be taken to avoid performance degradation or loss of functionality.

Table 14. Maximum Continuous Working Voltage¹

| Parameter | Max | Unit | Constraint |
|-------------------------------|------|--------|--|
| AC Voltage, Bipolar Waveform | 565 | V peak | 50-year minimum lifetime |
| AC Voltage, Unipolar Waveform | | | |
| Basic Insulation | 1131 | V peak | Maximum approved working voltage per IEC 60950-1 |
| Reinforced Insulation | 560 | V peak | Maximum approved working voltage per IEC 60950-1 and VDE V 0884-10 |
| DC Voltage | | | |
| Basic Insulation | 1131 | V peak | Maximum approved working voltage per IEC 60950-1 |
| Reinforced Insulation | 560 | V peak | Maximum approved working voltage per IEC 60950-1 and VDE V 0884-10 |

¹ Refers to continuous voltage magnitude imposed across the isolation barrier. See the Insulation Lifetime section for more details.

Table 15. Truth Table (Positive Logic)

| V _{ix} Input ¹ | V _{Ex} Input ^{1,2} | V _{DD1} State ¹ | V _{DD0} State ¹ | V _{Ox} Output ¹ | Notes |
|------------------------------------|--------------------------------------|-------------------------------------|-------------------------------------|-------------------------------------|--|
| H | H or NC | Powered | Powered | H | |
| L | H or NC | Powered | Powered | L | |
| X | L | Powered | Powered | Z | |
| X | H or NC | Unpowered | Powered | H | Outputs return to the input state within 1 μs of V _{DD1} power restoration. |
| X | L | Unpowered | Powered | Z | |
| X | X | Powered | Unpowered | Indeterminate | Outputs return to the input state within 1 μs of V _{DD0} power restoration if the V _{Ex} state is H or NC. Outputs return to a high impedance state within 8 ns of V _{DD0} power restoration if the V _{Ex} state is L. |

¹ V_{ix} and V_{Ox} refer to the input and output signals of a given channel (A, B, or C). V_{Ex} refers to the output enable signal on the same side as the V_{Ox} outputs. V_{DD1} and V_{DD0} refer to the supply voltages on the input and output sides of the given channel, respectively.

² In noisy environments, connecting V_{Ex} to an external logic high or low is recommended.

PIN CONFIGURATIONS AND FUNCTION DESCRIPTIONS

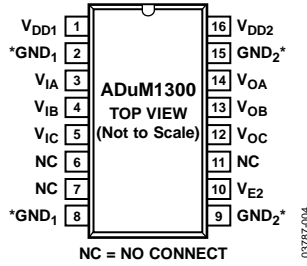

*PIN 2 AND PIN 8 ARE INTERNALLY CONNECTED, AND CONNECTING BOTH TO GND₁ IS RECOMMENDED. PIN 9 AND PIN 15 ARE INTERNALLY CONNECTED, AND CONNECTING BOTH TO GND₂ IS RECOMMENDED.

Figure 4. ADuM1300 Pin Configuration

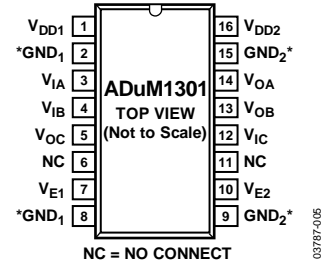

*PIN 2 AND PIN 8 ARE INTERNALLY CONNECTED, AND CONNECTING BOTH TO GND₁ IS RECOMMENDED. PIN 9 AND PIN 15 ARE INTERNALLY CONNECTED, AND CONNECTING BOTH TO GND₂ IS RECOMMENDED.

Figure 5. ADuM1301 Pin Configuration

Table 16. ADuM1300 Pin Function Descriptions

| Pin No. | Mnemonic | Description |
|---------|------------------|--|
| 1 | V _{DD1} | Supply Voltage for Isolator Side 1. |
| 2 | GND ₁ | Ground 1. Ground reference for Isolator Side 1. |
| 3 | V _{IA} | Logic Input A. |
| 4 | V _{IB} | Logic Input B. |
| 5 | V _{IC} | Logic Input C. |
| 6 | NC | No Connect. |
| 7 | NC | No Connect. |
| 8 | GND ₁ | Ground 1. Ground reference for Isolator Side 1. |
| 9 | GND ₂ | Ground 2. Ground reference for Isolator Side 2. |
| 10 | V _{E2} | Output Enable 2. Active high logic input. V _{OA} , V _{OB} , and V _{OC} outputs are enabled when V _{E2} is high or disconnected. V _{OA} , V _{OB} , and V _{OC} outputs are disabled when V _{E2} is low. In noisy environments, connecting V _{E2} to an external logic high or low is recommended. |
| 11 | NC | No Connect. |
| 12 | V _{OC} | Logic Output C. |
| 13 | V _{OB} | Logic Output B. |
| 14 | V _{OA} | Logic Output A. |
| 15 | GND ₂ | Ground 2. Ground reference for Isolator Side 2. |
| 16 | V _{DD2} | Supply Voltage for Isolator Side 2. |

Table 17. ADuM1301 Pin Function Descriptions

| Pin No. | Mnemonic | Description |
|---------|------------------|--|
| 1 | V _{DD1} | Supply Voltage for Isolator Side 1. |
| 2 | GND ₁ | Ground 1. Ground reference for Isolator Side 1. |
| 3 | V _{IA} | Logic Input A. |
| 4 | V _{IB} | Logic Input B. |
| 5 | V _{OC} | Logic Output C. |
| 6 | NC | No Connect. |
| 7 | V _{E1} | Output Enable 1. Active high logic input. V _{OC} output is enabled when V _{E1} is high or disconnected. V _{OC} output is disabled when V _{E1} is low. In noisy environments, connecting V _{E1} to an external logic high or low is recommended. |
| 8 | GND ₁ | Ground 1. Ground reference for Isolator Side 1. |
| 9 | GND ₂ | Ground 2. Ground reference for Isolator Side 2. |
| 10 | V _{E2} | Output Enable 2. Active high logic input. V _{OA} and V _{OB} outputs are enabled when V _{E2} is high or disconnected. V _{OA} and V _{OB} outputs are disabled when V _{E2} is low. In noisy environments, connecting V _{E2} to an external logic high or low is recommended. |
| 11 | NC | No Connect. |
| 12 | V _{IC} | Logic Input C. |
| 13 | V _{OB} | Logic Output B. |
| 14 | V _{OA} | Logic Output A. |
| 15 | GND ₂ | Ground 2. Ground reference for Isolator Side 2. |
| 16 | V _{DD2} | Supply Voltage for Isolator Side 2. |

TYPICAL PERFORMANCE CHARACTERISTICS

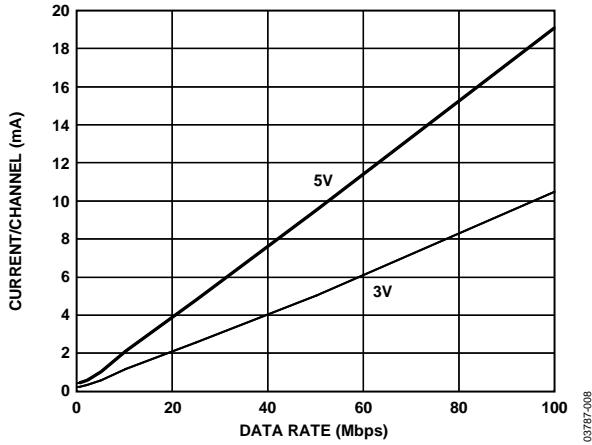

Figure 6. Typical Input Supply Current per Channel vs. Data Rate for 5 V and 3 V Operation

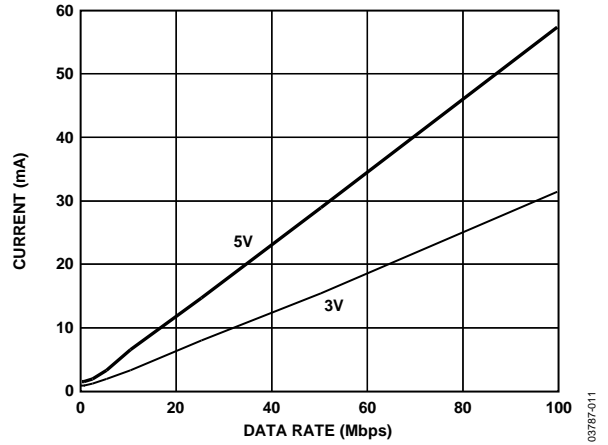

Figure 9. Typical ADuM1300 V_{DD1} Supply Current vs. Data Rate for 5 V and 3 V Operation

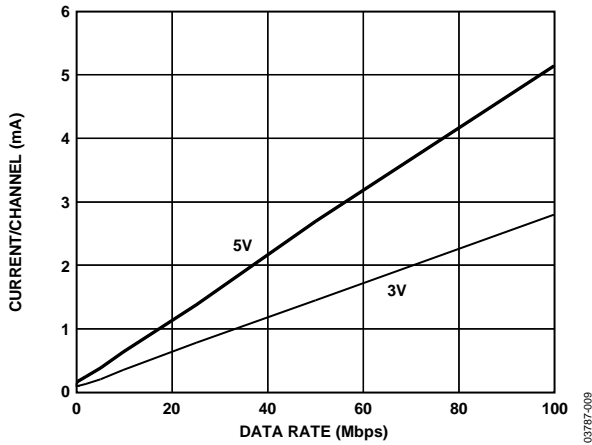

Figure 7. Typical Output Supply Current per Channel vs. Data Rate for 5 V and 3 V Operation (No Output Load)

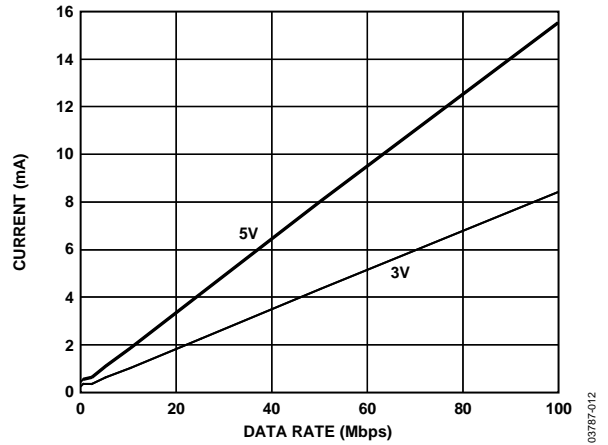

Figure 10. Typical ADuM1300 V_{DD2} Supply Current vs. Data Rate for 5 V and 3 V Operation

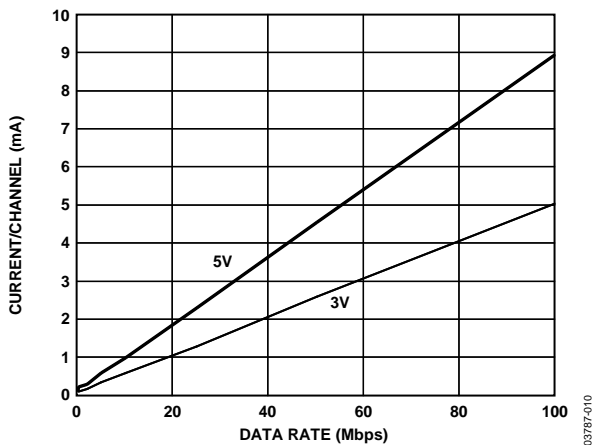

Figure 8. Typical Output Supply Current per Channel vs. Data Rate for 5 V and 3 V Operation (15 pF Output Load)

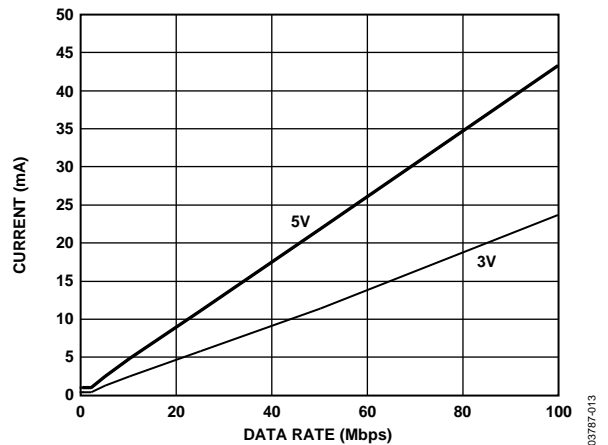

Figure 11. Typical ADuM1301 V_{DD1} Supply Current vs. Data Rate for 5 V and 3 V Operation

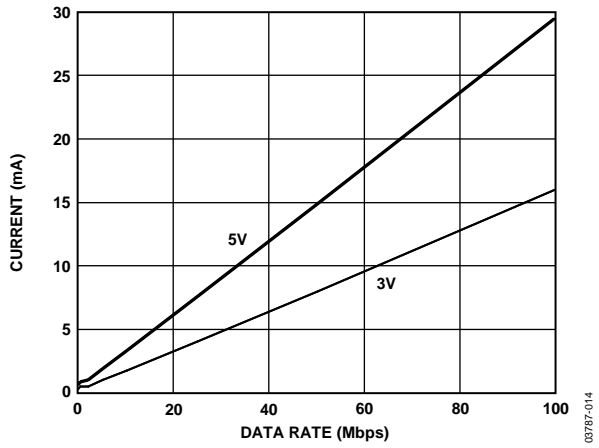

Figure 12. Typical ADuM1301 V_{DD2} Supply Current vs. Data Rate for 5 V and 3 V Operation

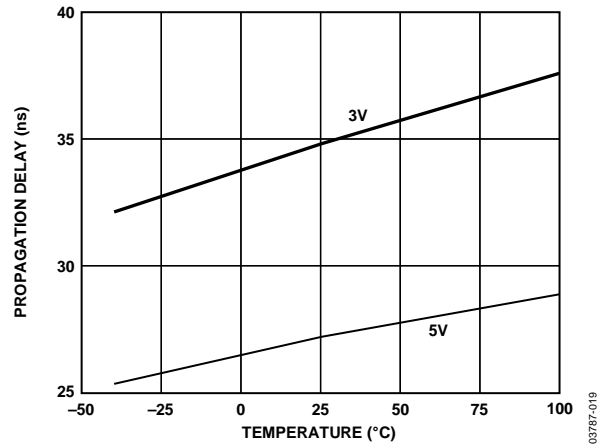

Figure 13. Propagation Delay vs. Temperature, C Grade

APPLICATIONS INFORMATION

PRINTED CIRCUIT BOARD (PCB) LAYOUT

The ADuM1300/ADuM1301 digital isolator requires no external interface circuitry for the logic interfaces. Power supply bypassing is strongly recommended at the input and output supply pins (see Figure 14). Bypass capacitors are most conveniently connected between Pin 1 and Pin 2 for V_{DD1} and between Pin 15 and Pin 16 for V_{DD2}. The capacitor value should be between 0.01 μF and 0.1 μF. The total lead length between both ends of the capacitor and the input power supply pin should not exceed 20 mm. Bypassing between Pin 1 and Pin 8 and between Pin 9 and Pin 16 should also be considered unless the ground pair on each package side is connected close to the package.

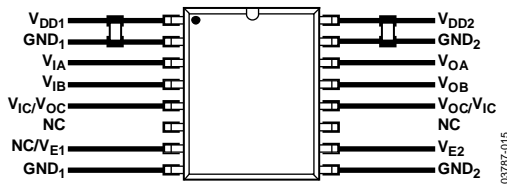

Figure 14. Recommended Printed Circuit Board Layout

In applications involving high common-mode transients, take care to ensure that board coupling across the isolation barrier is minimized. Furthermore, the board layout should be designed such that any coupling that does occur equally affects all pins on a given component side. Failure to ensure this could cause voltage differentials between pins exceeding the absolute maximum ratings of the device, thereby leading to latch-up or permanent damage.

See the AN-1109 Application Note for board layout guidelines.

PROPAGATION DELAY-RELATED PARAMETERS

Propagation delay is a parameter that describes the time it takes a logic signal to propagate through a component. The propagation delay to a logic low output may differ from the propagation delay to a logic high output.

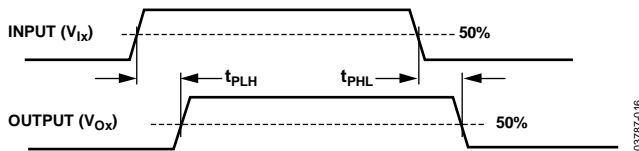

Figure 15. Propagation Delay Parameters

Pulse width distortion is the maximum difference between these two propagation delay values and is an indication of how accurately the timing of the input signal is preserved.

Channel-to-channel matching refers to the maximum amount that the propagation delay differs between channels within a single ADuM1300/ADuM1301 component.

Propagation delay skew refers to the maximum amount that the propagation delay differs between multiple ADuM1300/ADuM1301 components operating under the same conditions.

DC CORRECTNESS AND MAGNETIC FIELD IMMUNITY

Positive and negative logic transitions at the isolator input cause narrow (approximately 1 ns) pulses to be sent to the decoder via the transformer. The decoder is bistable and is therefore either set or reset by the pulses, indicating input logic transitions. In the absence of logic transitions at the input for more than approximately 1 μs, a periodic set of refresh pulses indicative of the correct input state are sent to ensure dc correctness at the output. If the decoder receives no internal pulses for more than about 5 μs, the input side is assumed to be unpowered or nonfunctional, in which case the isolator output is forced to a default state (see Table 15) by the watchdog timer circuit.

The ADuM1300/ADuM1301 is extremely immune to external magnetic fields. The limitation on the magnetic field immunity of the ADuM1300/ADuM1301 is set by the condition in which induced voltage in the receiving coil of the transformer is sufficiently large enough to either falsely set or reset the decoder. The following analysis defines the conditions under which this may occur. The 3 V operating condition of the ADuM1300/ADuM1301 is examined because it represents the most susceptible mode of operation.

The pulses at the transformer output have an amplitude greater than 1.0 V. The decoder has a sensing threshold at about 0.5 V, thus establishing a 0.5 V margin in which induced voltages can be tolerated. The voltage induced across the receiving coil is given by

$$V = (-d\beta/dt)\sum n r_n^2; n = 1, 2, \dots, N$$

where:

β is magnetic flux density (gauss).

N is the number of turns in the receiving coil.

r_n is the radius of the n^{th} turn in the receiving coil (cm).

Given the geometry of the receiving coil in the ADuM1300/ADuM1301 and an imposed requirement that the induced voltage be 50% at most of the 0.5 V margin at the decoder, a maximum allowable magnetic field is calculated as shown in Figure 16.

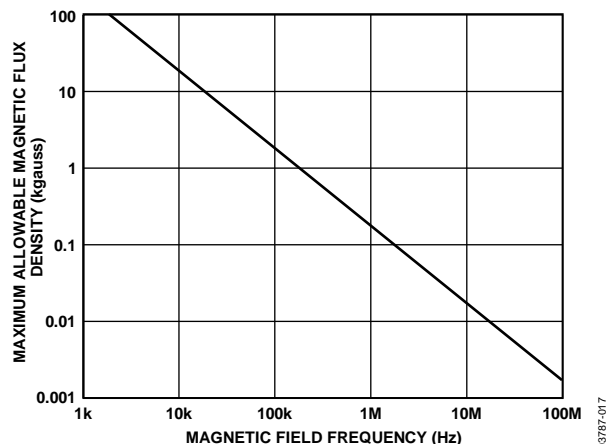

Figure 16. Maximum Allowable External Magnetic Flux Density

For example, at a magnetic field frequency of 1 MHz, the maximum allowable magnetic field of 0.2 kgauss induces a voltage of 0.25 V at the receiving coil. This is about 50% of the sensing threshold and does not cause a faulty output transition. Similarly, if such an event occurs during a transmitted pulse (and has the worst-case polarity), it reduces the received pulse from >1.0 V to 0.75 V—still well above the 0.5 V sensing threshold of the decoder.

The preceding magnetic flux density values correspond to specific current magnitudes at given distances from the ADuM1300/ADuM1301 transformers. Figure 17 shows these allowable current magnitudes as a function of frequency for selected distances. The ADuM1300/ADuM1301 is extremely immune and can be affected only by extremely large currents operated at a high frequency very close to the component. For the 1 MHz example noted, one would have to place a 0.5 kA current 5 mm away from the ADuM1300/ADuM1301 to affect the operation of the component.

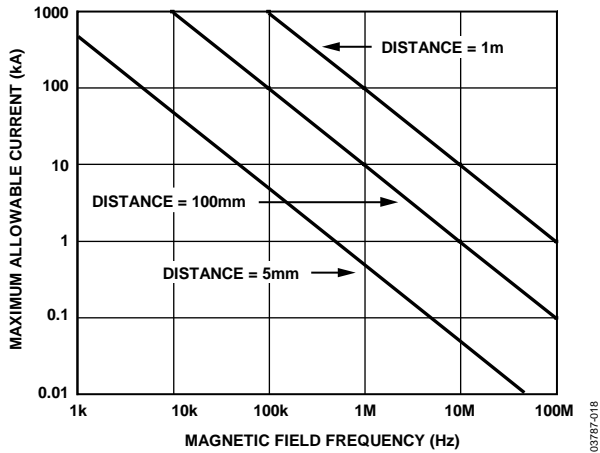

Figure 17. Maximum Allowable Current for Various Current-to-ADuM1300/ADuM1301 Spacings

Note that at combinations of strong magnetic field and high frequency, any loops formed by printed circuit board traces could induce error voltages sufficiently large enough to trigger the thresholds of succeeding circuitry. Take care in the layout of such traces to avoid this possibility.

POWER CONSUMPTION

The supply current at a given channel of the ADuM1300/ADuM1301 isolator is a function of the supply voltage, the data rate of the channel, and the output load of the channel.

For each input channel, the supply current is given by

$$I_{DD1} = I_{DD1(Q)} \quad f \leq 0.5 f_r$$

$$I_{DD1} = I_{DD1(D)} \times (2f - f_r) + I_{DD1(Q)} \quad f > 0.5 f_r$$

For each output channel, the supply current is given by

$$I_{DDO} = I_{DDO(Q)} \quad f \leq 0.5 f_r$$

$$I_{DDO} = (I_{DDO(D)} + (0.5 \times 10^{-3}) \times C_L \times V_{DDO}) \times (2f - f_r) + I_{DDO(Q)} \quad f > 0.5 f_r$$

where:

$I_{DD1(D)}$, $I_{DDO(D)}$ are the input and output dynamic supply currents per channel (mA/Mbps).

C_L is the output load capacitance (pF).

V_{DDO} is the output supply voltage (V).

f is the input logic signal frequency (MHz); it is half of the input data rate expressed in units of Mbps.

f_r is the input stage refresh rate (Mbps).

$I_{DD1(Q)}$, $I_{DDO(Q)}$ are the specified input and output quiescent supply currents (mA).

To calculate the total V_{DD1} and V_{DD2} supply current, the supply currents for each input and output channel corresponding to V_{DD1} and V_{DD2} are calculated and totaled. Figure 6 and Figure 7 provide per-channel supply currents as a function of data rate for an unloaded output condition. Figure 8 provides per-channel supply current as a function of data rate for a 15 pF output condition. Figure 9 through Figure 12 provide total V_{DD1} and V_{DD2} supply current as a function of data rate for ADuM1300/ADuM1301 channel configurations.

INSULATION LIFETIME

All insulation structures eventually break down when subjected to voltage stress over a sufficiently long period. The rate of insulation degradation is dependent on the characteristics of the voltage waveform applied across the insulation. In addition to the testing performed by the regulatory agencies, Analog Devices carries out an extensive set of evaluations to determine the lifetime of the insulation structure within the [ADuM1300/ADuM1301](#).

Analog Devices performs accelerated life testing using voltage levels higher than the rated continuous working voltage. Acceleration factors for several operating conditions are determined. These factors allow calculation of the time to failure at the actual working voltage. The values shown in Table 14 summarize the peak voltage for 50 years of service life for a bipolar ac operating condition and the maximum CSA/VDE approved working voltages. In many cases, the approved working voltage is higher than the 50-year service life voltage. Operation at these high working voltages can lead to shortened insulation life in some cases.

The insulation lifetime of the [ADuM1300/ADuM1301](#) depends on the voltage waveform type imposed across the isolation barrier. The *iCoupler* insulation structure degrades at different rates depending on whether the waveform is bipolar ac, unipolar ac, or dc. Figure 18, Figure 19, and Figure 20 illustrate these different isolation voltage waveforms, respectively.

Bipolar ac voltage is the most stringent environment. The goal of a 50-year operating lifetime under the ac bipolar condition determines the Analog Devices recommended maximum working voltage.

In the case of unipolar ac or dc voltage, the stress on the insulation is significantly lower, which allows operation at higher working voltages while still achieving a 50-year service life. The working voltages listed in Table 14 can be applied while maintaining the 50-year minimum lifetime provided the voltage conforms to either the unipolar ac or dc voltage cases. Any cross insulation voltage waveform that does not conform to Figure 19 or Figure 20 should be treated as a bipolar ac waveform, and its peak voltage should be limited to the 50-year lifetime voltage value listed in Table 14.

Note that the voltage presented in Figure 19 is shown as sinusoidal for illustration purposes only. It is meant to represent any voltage waveform varying between 0 V and some limiting value. The limiting value can be positive or negative, but the voltage cannot cross 0 V.

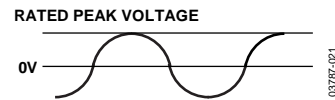

Figure 18. Bipolar AC Waveform

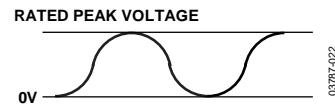

Figure 19. Unipolar AC Waveform

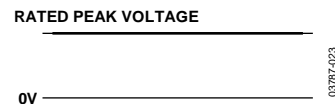
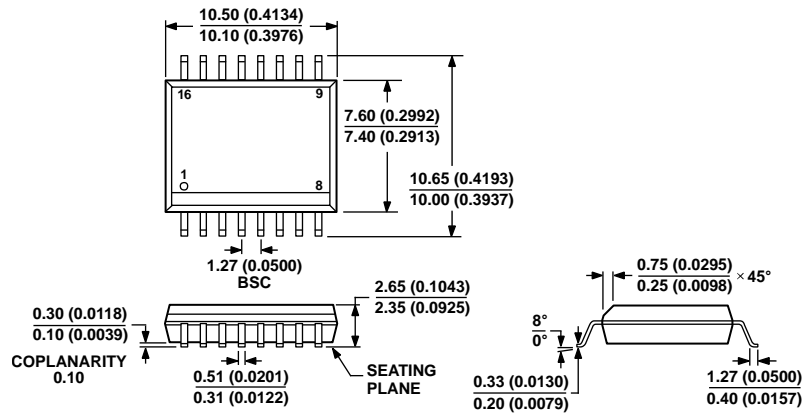

Figure 20. DC Waveform

OUTLINE DIMENSIONS



COMPLIANT TO JEDEC STANDARDS MS-013-AA
 CONTROLLING DIMENSIONS ARE IN MILLIMETERS; INCH DIMENSIONS
 (IN PARENTHESES) ARE ROUNDED-OFF MILLIMETER EQUIVALENTS FOR
 REFERENCE ONLY AND ARE NOT APPROPRIATE FOR USE IN DESIGN.

Figure 21. 16-Lead Standard Small Outline Package [SOIC_W]
 Wide Body (RW-16)
 Dimensions shown in millimeters (and inches)

03-27-2007-B

ORDERING GUIDE

| Model ^{1, 2, 3} | Number of Inputs, V _{DD1} Side | Number of Inputs, V _{DD2} Side | Maximum Data Rate (Mbps) | Maximum Propagation Delay, 5 V (ns) | Maximum Pulse Width Distortion (ns) | Temperature Range | Package Option ⁴ |
|--------------------------|---|---|--------------------------|-------------------------------------|-------------------------------------|-------------------|-----------------------------|
| ADuM1300ARW | 3 | 0 | 1 | 100 | 40 | -40°C to +105°C | RW-16 |
| ADuM1300ARW-RL | 3 | 0 | 1 | 100 | 40 | -40°C to +105°C | RW-16 |
| ADuM1300ARWZ | 3 | 0 | 1 | 100 | 40 | -40°C to +105°C | RW-16 |
| ADuM1300ARWZ-RL | 3 | 0 | 1 | 100 | 40 | -40°C to +105°C | RW-16 |
| ADuM1300BRWZ | 3 | 0 | 10 | 50 | 3 | -40°C to +105°C | RW-16 |
| ADuM1300BRWZ-RL | 3 | 0 | 10 | 50 | 3 | -40°C to +105°C | RW-16 |
| ADuM1300CRWZ | 3 | 0 | 90 | 32 | 2 | -40°C to +105°C | RW-16 |
| ADuM1300CRWZ-RL | 3 | 0 | 90 | 32 | 2 | -40°C to +105°C | RW-16 |
| ADuM1300WSRWZ | 3 | 0 | 1 | 100 | 40 | -40°C to +125°C | RW-16 |
| ADuM1300WSRWZ-RL | 3 | 0 | 1 | 100 | 40 | -40°C to +125°C | RW-16 |
| ADuM1300WTRWZ | 3 | 0 | 10 | 32 | 3 | -40°C to +125°C | RW-16 |
| ADuM1300WTRWZ-RL | 3 | 0 | 10 | 32 | 3 | -40°C to +125°C | RW-16 |
| ADuM1301ARW | 2 | 1 | 1 | 100 | 40 | -40°C to +105°C | RW-16 |
| ADuM1301ARW-RL | 2 | 1 | 1 | 100 | 40 | -40°C to +105°C | RW-16 |
| ADuM1301ARWZ | 2 | 1 | 1 | 100 | 40 | -40°C to +105°C | RW-16 |
| ADuM1301ARWZ-RL | 2 | 1 | 1 | 100 | 40 | -40°C to +105°C | RW-16 |
| ADuM1301BRW | 2 | 1 | 10 | 50 | 3 | -40°C to +105°C | RW-16 |
| ADuM1301BRW-RL | 2 | 1 | 10 | 50 | 3 | -40°C to +105°C | RW-16 |
| ADuM1301BRWZ | 2 | 1 | 10 | 50 | 3 | -40°C to +105°C | RW-16 |
| ADuM1301BRWZ-RL | 2 | 1 | 10 | 50 | 3 | -40°C to +105°C | RW-16 |
| ADuM1301CRW | 2 | 1 | 90 | 32 | 2 | -40°C to +105°C | RW-16 |
| ADuM1301CRWZ | 2 | 1 | 90 | 32 | 2 | -40°C to +105°C | RW-16 |
| ADuM1301CRWZ-RL | 2 | 1 | 90 | 32 | 2 | -40°C to +105°C | RW-16 |
| ADuM1301WSRWZ | 2 | 1 | 1 | 100 | 40 | -40°C to +125°C | RW-16 |
| ADuM1301WSRWZ-RL | 2 | 1 | 1 | 100 | 40 | -40°C to +125°C | RW-16 |
| ADuM1301WTRWZ | 2 | 1 | 10 | 32 | 3 | -40°C to +125°C | RW-16 |
| ADuM1301WTRWZ-RL | 2 | 1 | 10 | 32 | 3 | -40°C to +125°C | RW-16 |
| EVAL-ADuMQSEBZ | | | | | | | |

¹ Z = RoHS Compliant Part.

² W = Qualified for Automotive Applications.

³ The addition of an -RL suffix designates a 13" (1,000 units) tape-and-reel option.

⁴ RW-16 = 16-lead wide body SOIC.

AUTOMOTIVE PRODUCTS

The [ADuM1300W/ADuM1301W](#) models are available with controlled manufacturing to support the quality and reliability requirements of automotive applications. Note that these automotive models may have specifications that differ from the commercial models; therefore, designers should review the Specifications section of this data sheet carefully. Only the automotive grade products shown are available for use in automotive applications. Contact your local Analog Devices account representative for specific product ordering information and to obtain the specific Automotive Reliability reports for these models.

NOTES

NOTES

NOTES