

Features

Regulated Converters

- 2:1 Wide Input Range Regulated Converter
- 2W In Compact SMD Package
- -40°C To +85°C Operating Temperature @ Full Load
- high 3kVDC/1 Second (1kVAC/1 Minute)
- Continuous Short Circuit Protection
- IEC/EN62368-1 Certified (CB Scheme)

Description

The RTC2 is a 2W, open-frame, SMD, isolated DC/DC converter with 2:1 input voltage range. It is available with 5V (4.5-9V) or 24V (18-36V) inputs and offers a single 5V output which is short circuit protected. The output is tightly regulated with less than 50mV output ripple. There is no minimum load requirement. The operating temperature is -40°C up to 100°C (with derating). Isolation is 3kVDC/1kVAC (functional Isolation) and a control pin is fitted as standard. The converter is IEC/EN62368-1 certified and is 10/10 RoHS-conform. Class B EMC conformity can be reached with a simple external LC filter.

Selection Guide

Part Number	nom. Input Voltage [VDC]	Output Voltage [VDC]	Output Current [mA]	Efficiency typ. ⁽¹⁾ [%]	max. Capacitive Load ⁽²⁾ [µF]
RTC2-0505SRW	4.5 - 9	5	400	76	4700
RTC2-2405SRW	18 - 36	5	400	80	4700

Notes:

Note1: Efficiency is tested at nominal input and full load at +25°C ambient.

Note2: Max. cap. load is tested at minimum input and full resistive load.

Model Numbering



Notes:

Note3: without suffix, standard tray packaging
add suffix „-R“ for Tape and Reel packaging

Ordering Examples:

RTC2-0505SRW = nom. Vin=5VDC, nom. Vout= 5VDC, standard 3kVDC/1 second isolation, tray packaging

RTC2-2405SRW-R = nom. Vin= 24VDC, nom. Vout= 5VDC, standard 3kVDC/1 second isolation, tape and reel packaging

Specifications (measured @ ta= 25°C, nominal Vin, full load and after warm up unless otherwise specified)

BASIC CHARACTERISTICS				
Parameter	Condition	Min.	Typ.	Max.
Internal Input Filter				capacitor
Input Voltage Range	nom. Vin= 5VDC 24VDC	4.5VDC 18VDC	5VDC 24VDC	9VDC 36VDC
Input Surge Voltage	100ms max. nom. Vin= 5VDC 24VDC		15VDC 50VDC	
Quiescent Current	nom. Vin= 5VDC 24VDC		40mA 3mA	

continued on next page

RTC2

2 Watt
SMD
Single Output

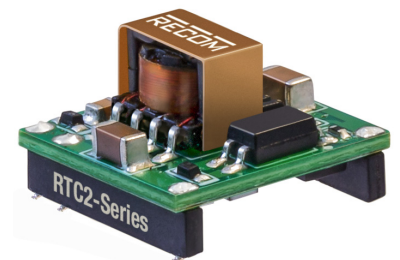

IEC/EN62368-1 Certified
CB Report
EN55022

Specifications (measured @ $t_a = 25^\circ\text{C}$, nominal V_{in} , full load and after warm up unless otherwise specified)

Parameter	Condition	Min.	Typ.	Max.
Start-up time			500 μs	
Rise Time			450 μs	
Hold-up Time			10 μs	
Internal Operating Frequency	nom $V_{in} =$ 5VDC 24VDC		180kHz 210kHz	
Minimum Load		0%		
Output Ripple and Noise ⁽⁴⁾	20MHz BW			50mVp-p
ON/OFF CTRL	DC-DC ON DC-DC OFF			Open or $0.0\text{V} < V_r < 0.8\text{VDC}$ $2\text{V} < V_r < 6\text{VDC}$
Input Current of CTRL Pin	nom $V_{in} =$ 5VDC 24VDC		40mA 16mA	
Standby Current			0.75mA	1.5mA

Notes:

Note4: Measurements are made with a 0.1 μF MLCC across output. (low ESR)

Efficiency vs. Load

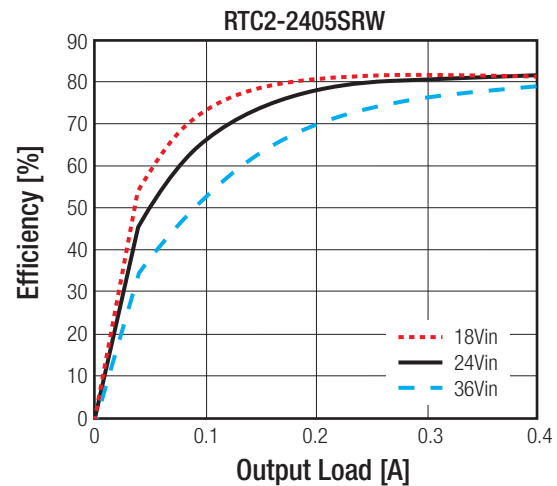
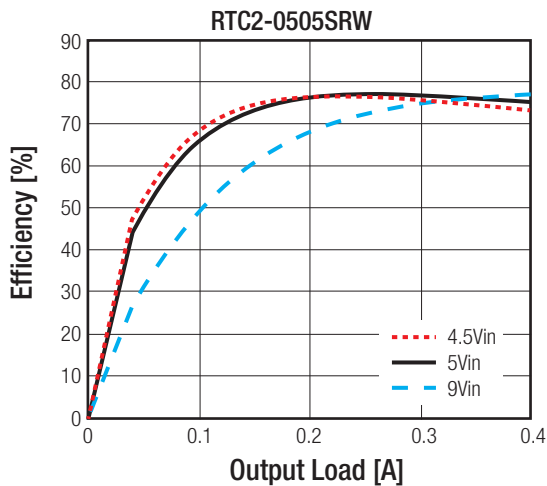

REGULATIONS

Parameter	Condition	Value
Output Accuracy		$\pm 2.0\%$ typ.
Line Regulation	low line to high line, full load	$\pm 0.2\%$ max.
Load Regulation	0% to 100% load	$\pm 0.5\%$ max.

Accuracy vs. Load

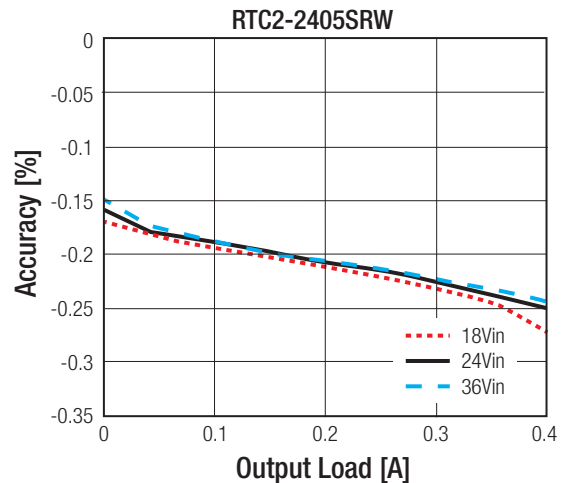
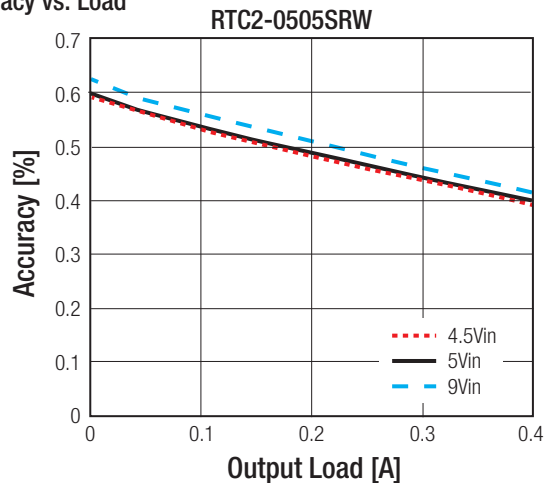

Specifications (measured @ $t_a = 25^\circ\text{C}$, nominal V_{in} , full load and after warm up unless otherwise specified)

PROTECTIONS			
Parameter	Type	Value	
Short Circuit Protection (SCP)	below $100\text{m}\Omega$	continuous, auto recovery	
Isolation Voltage ⁽⁵⁾	I/P to O/P	tested for 1 second	3kVDC
		rated for 1 minute	1kVAC ⁽⁷⁾
Isolation Resistance		$1\text{G}\Omega$ min.	
Isolation Capacitance		25pF typ.	
Insulation Grade		functional	

Protection Circuit

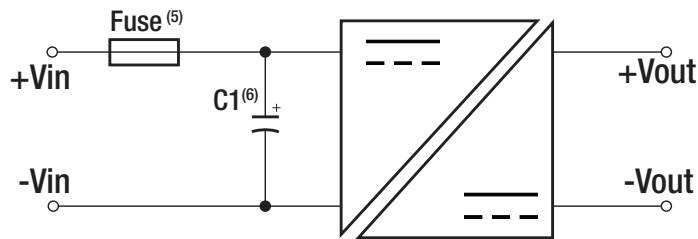

Notes:

- Note5: For repeat Hi-Pot testing, reduce the time and/or the test voltage
- Note6: An input fuse is required if the main supply is not over-current protected. Recommended fuse: T2A slow blow type
- Note7: An external input filter capacitor is required if the model has to meet EN6100-4-4 and EN61000-4-5
Recom suggested: Nippon chemi-con KY Series, 220 μF /100V ESR 48m Ω
- Note8: Customers are allowed to test once with 1kVAC/1 minute in their production. Thereafter the test voltage and time must be reduced for any repeat testing

ENVIRONMENTAL		
Parameter	Condition	Value
Operating Temperature Range	with derating (see graph)	-40°C to $+100^\circ\text{C}$
Temperature Coefficient		$\pm 0.05\%/^\circ\text{C}$
Operating Altitude		5000m
Operating Humidity	non-condensing	5% - 95% RH max.
Pollution Degree		PD2
Vibration		according to MIL-STD-202G
MTBF	according to MIL-HDBK-217F, G.B. $+25^\circ\text{C}$	2145×10^3 hours

Derating Graph

(@ Chamber and natural convection 0.1m/s)

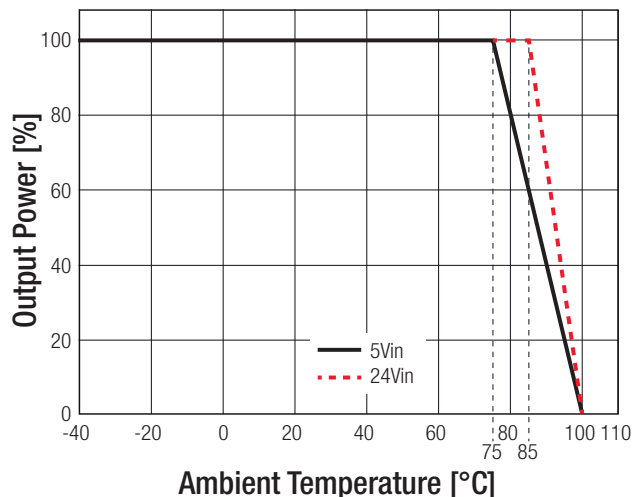

Specifications (measured @ $t_a = 25^\circ\text{C}$, nominal V_{in} , full load and after warm up unless otherwise specified)

SAFETY AND CERTIFICATIONS

Certificate Type (Safety)	Report / File Number	Standard
Audio/Video, information and communication technology equipment - Safety requirements (CB Scheme)	L0339m43-CB-1-B1	IEC62368-1, 2nd Edition, 2014 EN62368-1, 2014
RoHS2		RoHS-2011/65/EU + AM2 (10/10)

EMC Compliance

EMC Compliance	Condition	Standard / Criterion
Information technology equipment - Radio disturbance characteristics - Limits and methods of measurement	with external filter (see filter suggestion below)	EN55022, Class A EN55022, Class B
Electromagnetic compatibility of multimedia equipment - Emission requirements		EN55032, Class B
Information technology equipment - Immunity characteristics - Limits and methods of measurement		EN55024
ESD Electrostatic discharge immunity test	Air: $\pm 8\text{kV}$; Contact: $\pm 4\text{kV}$	EN61000-4-2, Criteria A
Radiated, radio-frequency, electromagnetic field immunity test	3V/m	EN61000-4-3, Criteria A
Fast Transient and Burst Immunity	DC Port: $\pm 0.5\text{kV}$	EN61000-4-4, Criteria A
Surge Immunity	DC Port: $\pm 1\text{kV}$	EN61000-4-5, Criteria B
Immunity to conducted disturbances, induced by radio-frequency fields	DC Port: 3V	EN61000-4-6, Criteria A
Power Magnetic Field Immunity	50Hz 1A/m	EN61000-4-8, Criteria A

EMC Filtering Suggestions according to EN55022 Class A

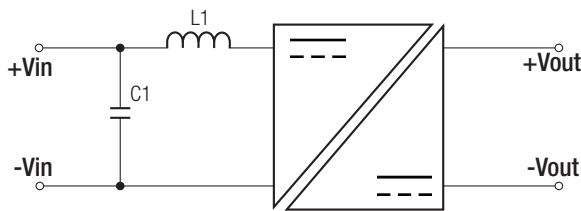

nom. Vin	C1	L1
5VDC	22 μF /16V MLCC	12 μH SMD Inductor
24VDC	22 μF /50V MLCC	22 μH SMD Inductor

EN55022 Class A Conducted Emissions

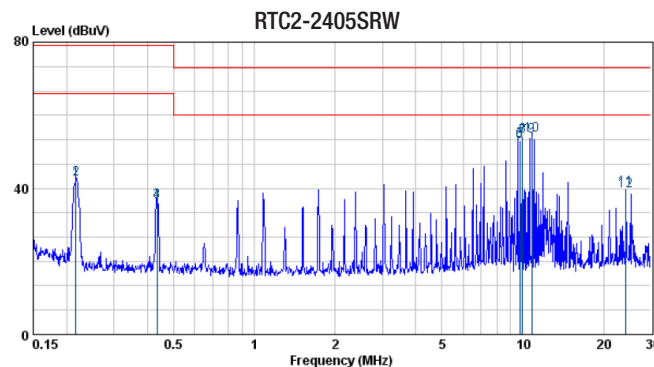
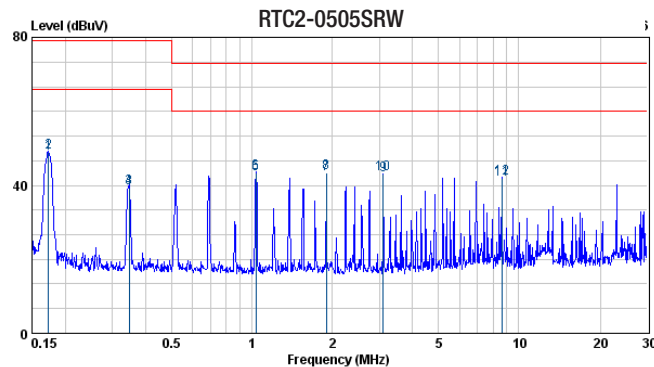

vcontinued on next page

Specifications (measured @ $t_a = 25^\circ\text{C}$, nominal V_{in} , full load and after warm up unless otherwise specified)

EMC Filtering Suggestions according to EN55022 Class B

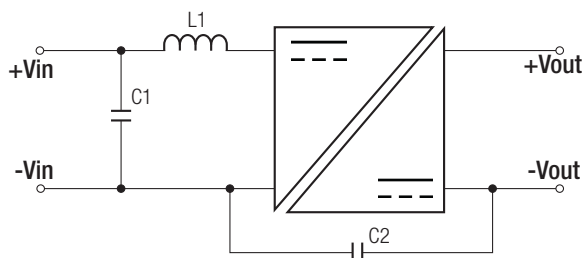

nom. V_{in}	C1	C2	L1
5VDC	22 μF /16V MLCC	220pF/4kV	12 μH SMD
24VDC	22 μF /50V MLCC	Disc ceramic	Inductor

EN55022 Class B Conducted Emissions

RTC2-0505SRW

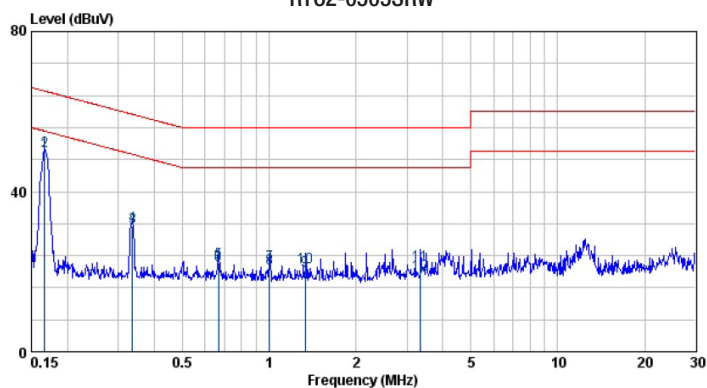

RTC2-2405SRW

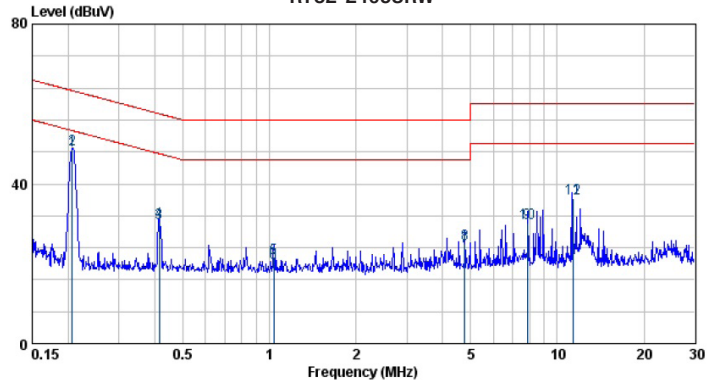

DIMENSION and PHYSICAL CHARACTERISTICS

Parameter	Type	Value
Material	Case (spacers) PCB	plastic (UL94 V-0) FR4 (UL94 V-0)
Package Dimension (LxWxH)		14.99 x 14.22 x 9.6mm
Package Weight		2.0g typ.

continued on next page

Specifications (measured @ $t_a = 25^\circ\text{C}$, nominal V_{in} , full load and after warm up unless otherwise specified)

Derating Graph

(@ Chamber and natural convection 0.1 m/s)

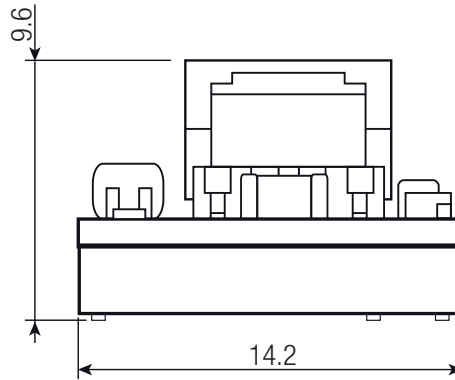
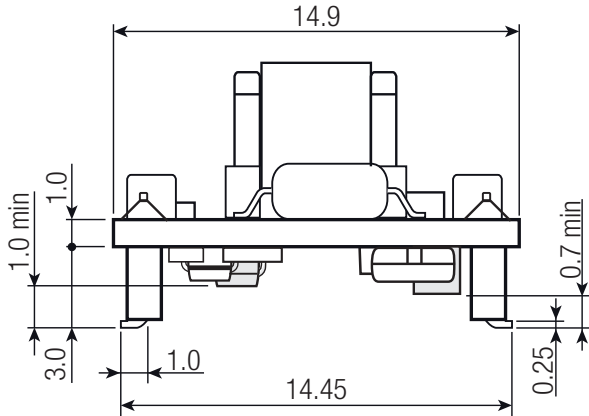
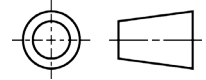

Pin Connection

Pin #	Function
1	+Vin
2	-Vin
3	CTRL
4	+Vout
5	-Vout

Tolerance: xx.x±0.5mm
xx.xx ±0.25mm
Pin dimension: ±0.1mm

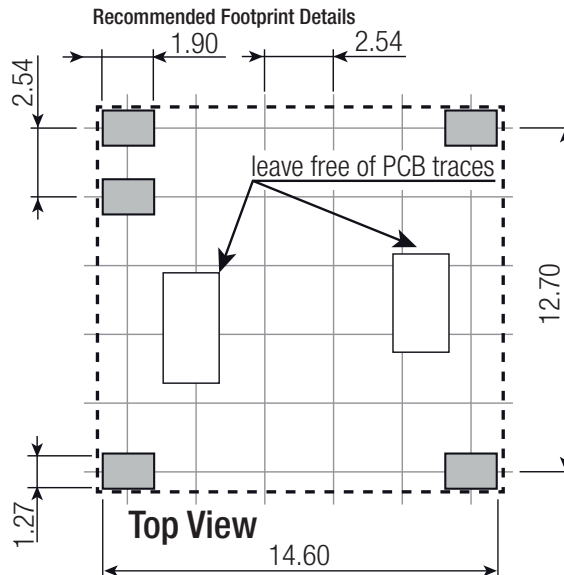
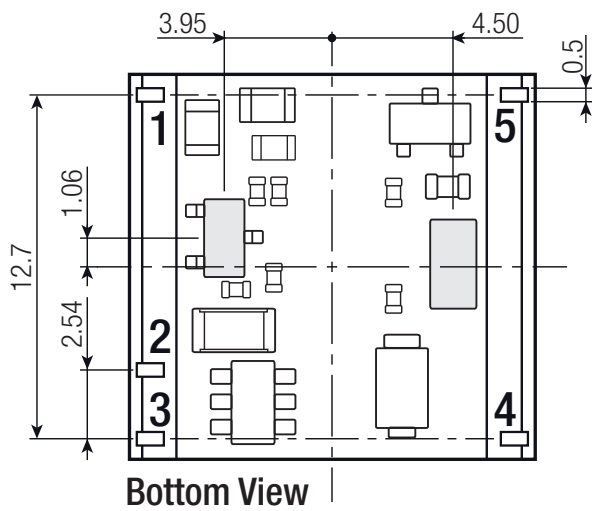

INSTALLATION and APPLICATION

ON/OFF CTRL Circuit

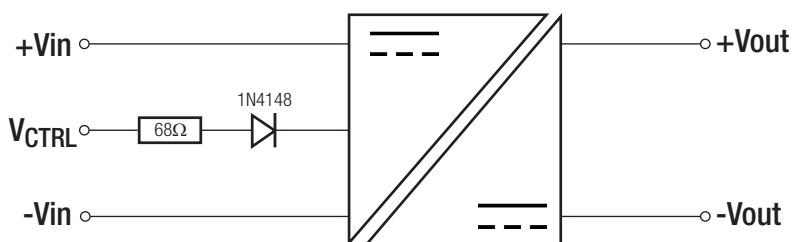

DC-DC ON: Open or $0V < V_r < 0.8VDC$
DC-DC OFF: $2V < V_r < 6VDC$

continued on next page

Specifications (measured @ $t_a = 25^\circ\text{C}$, nominal V_{in} , full load and after warm up unless otherwise specified)

Lead-free Recommended Solder Profile according to JEDEC STD-020D-01

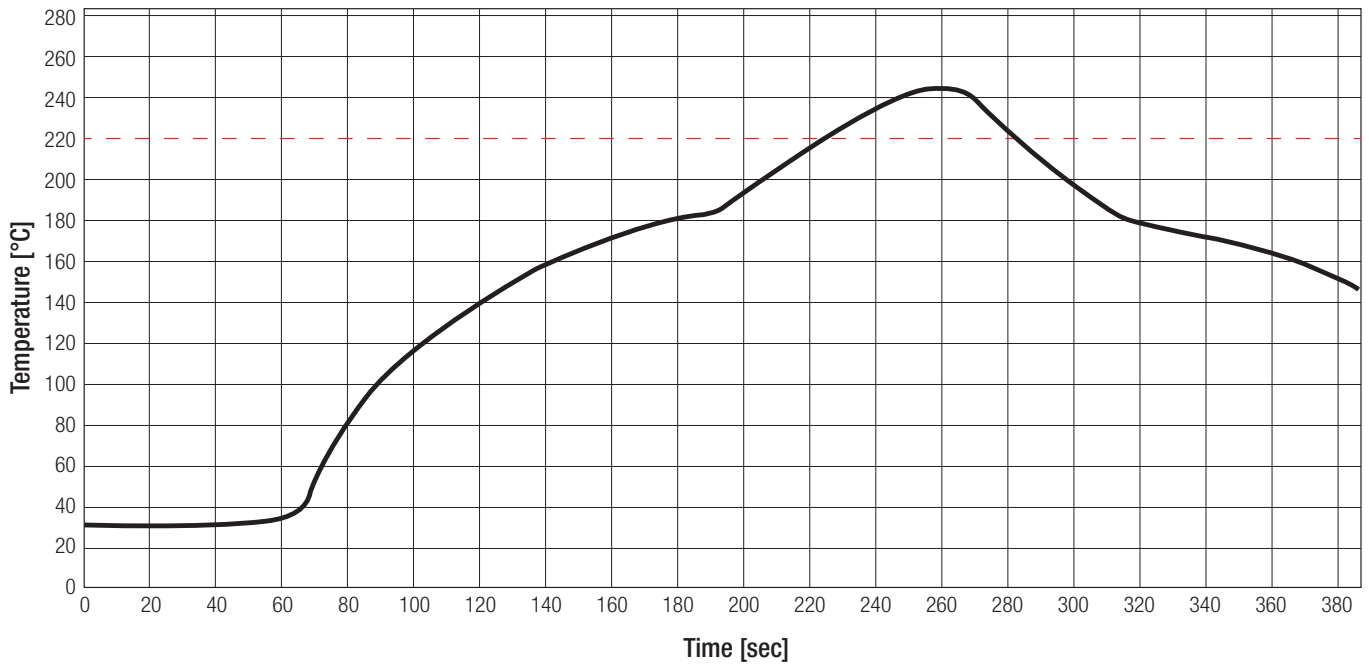

PACKAGING INFORMATION

Packaging Dimension (LxWxH)	tray carton	260.0 x 205.0 x 25.0mm
	tray	240.0 x 200.0 x 20.0mm
	tape and reel (-R) carton	385.0 x 375.0 x 70.0mm
	reel	330.0 x 50.0 x 330.0mm
Packaging Quantity	tray	30pcs
	tape and reel (-R)	200pcs
Tape Width		44mm
Storage Temperature Range		-55°C to +125°C
Storage Humidity		95% RH max.

The product information and specifications are subject to change without prior notice. RECOM products are not authorized for use in safety-critical applications (such as life support) without RECOM's explicit written consent. A safety-critical application is defined as an application where a failure of a RECOM product may reasonably be expected to endanger or cause loss of life, inflict bodily harm or damage property. The buyer shall indemnify and hold harmless RECOM, its affiliated companies and its representatives against any damage claims in connection with the unauthorized use of RECOM products in such safety-critical applications.