

A-A

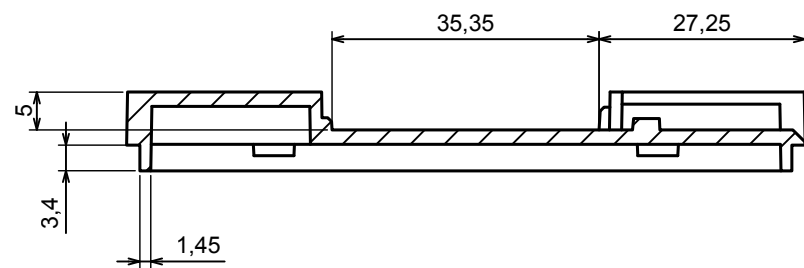

B-B

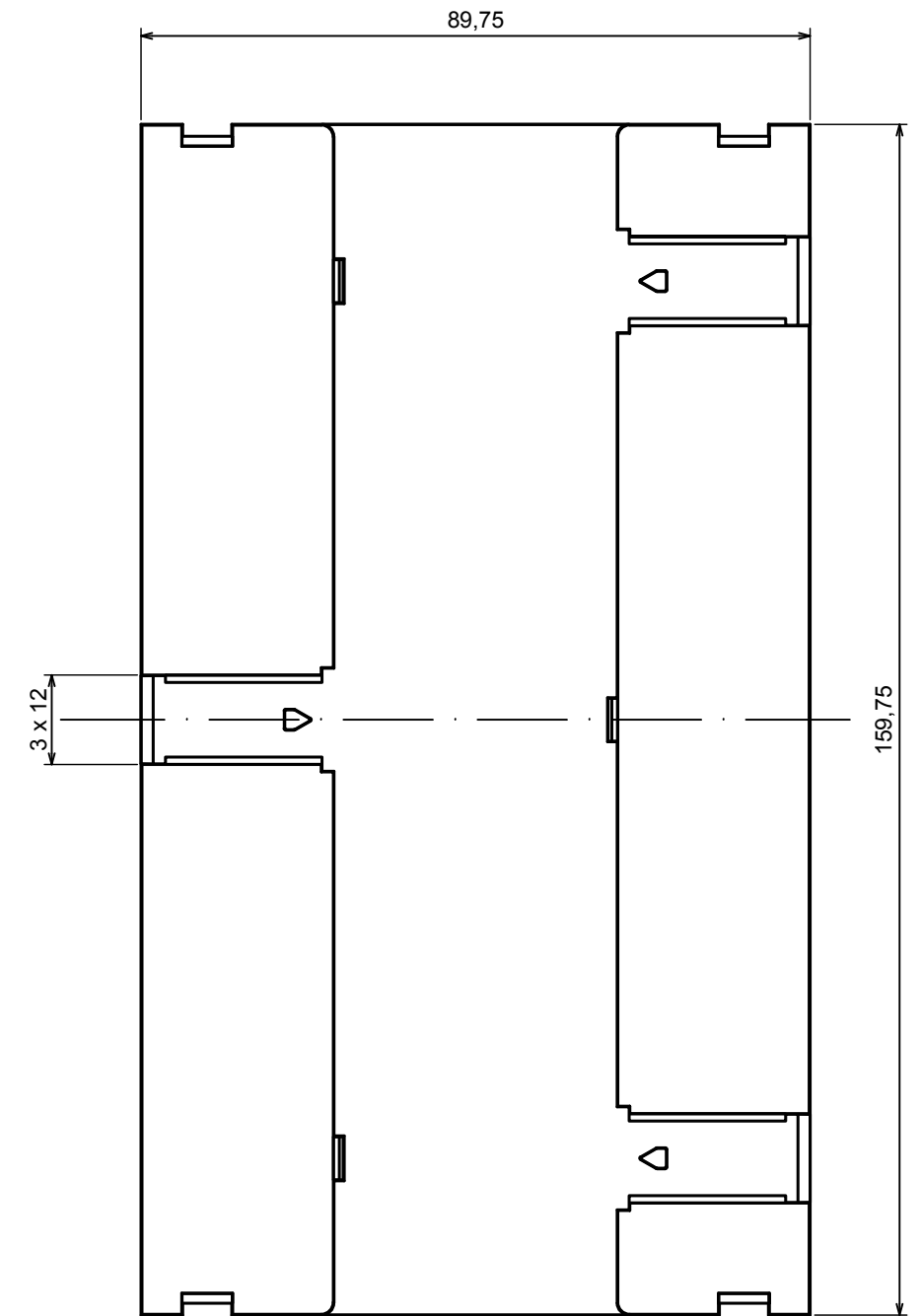

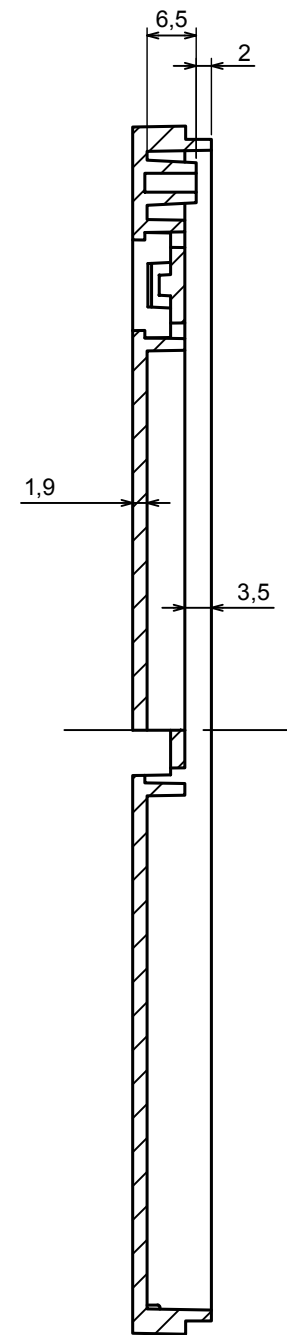
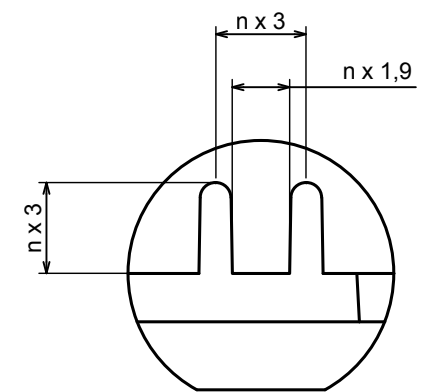
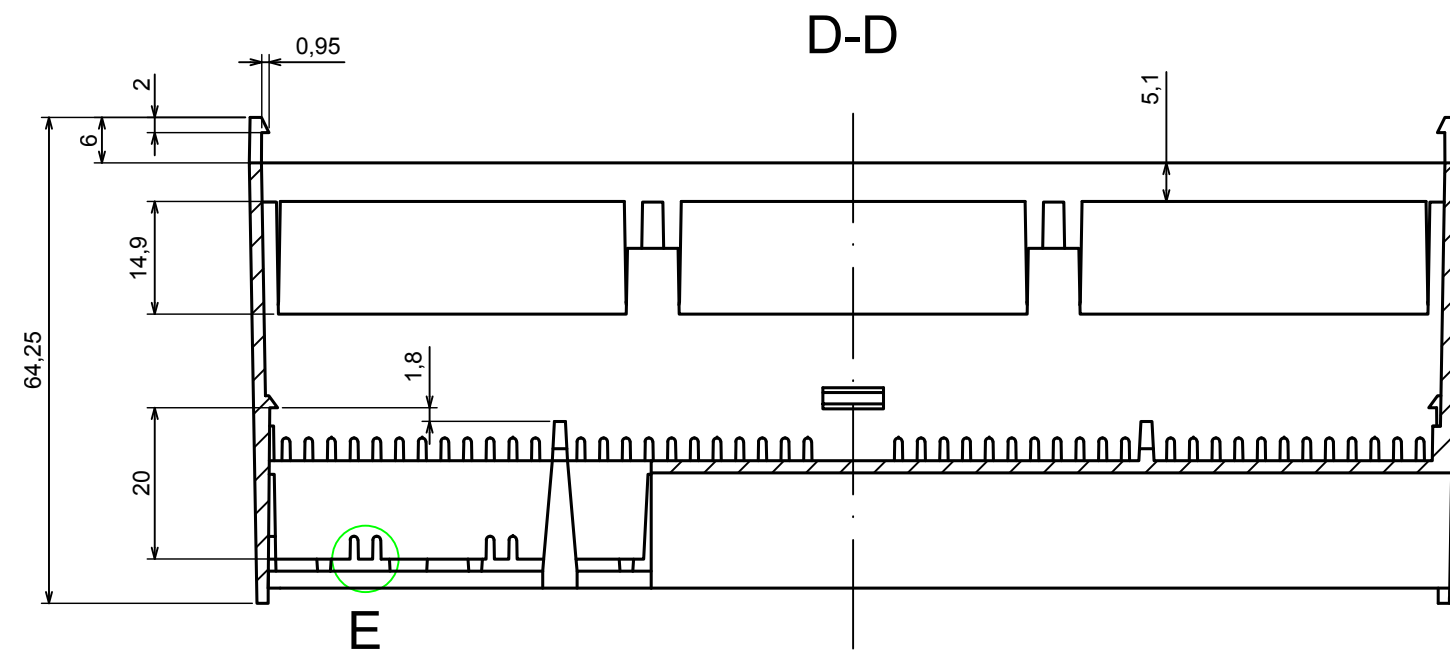
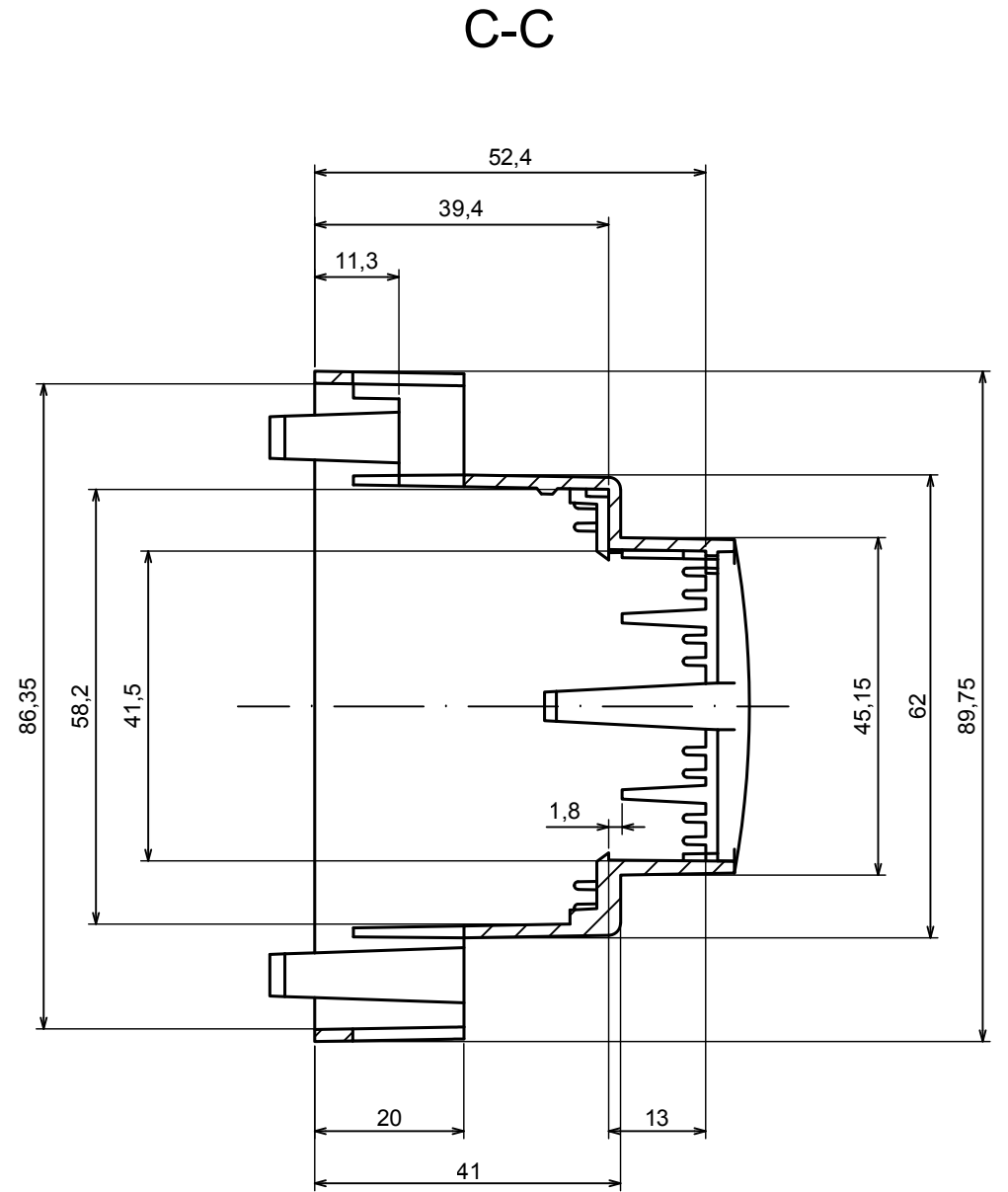
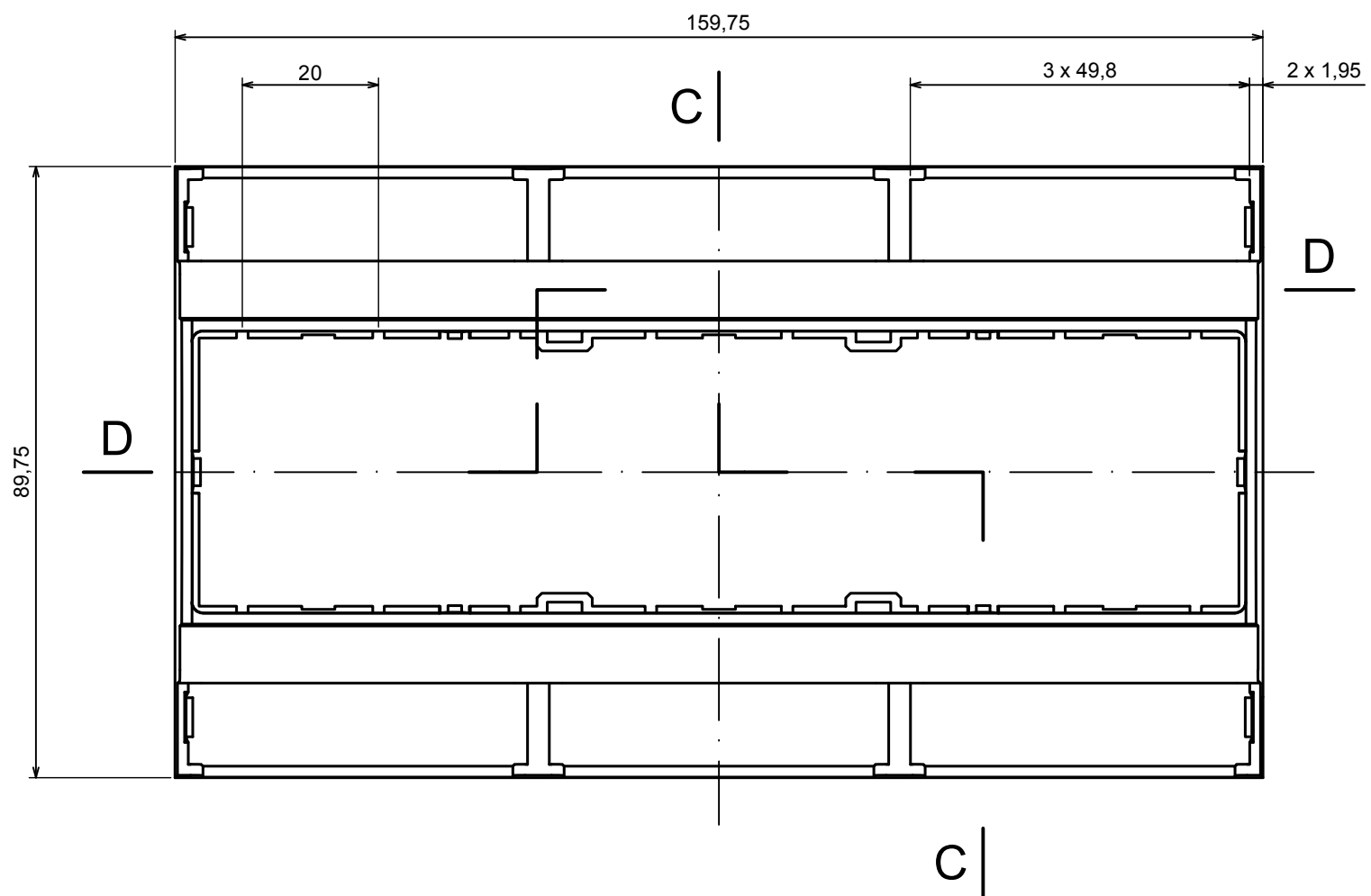

E (4.0000)

