

EEMB CO., LTD

Lithium Manganese Dioxide Battery Specification

Button Type

Model:	CR1220
Capacity:	40mAh

Prepared	Checked	Approved

Customer :

Customer Approval (Customer confirmation) :		
Signature	Checked	Approved

Address: Room ABCD, 25/F, Block A, Fortune Plaza, NO.7060 Shennan Road Shenzhen, China

Postal code: 518040

Phone: 0086-755-83022275

Fax: 0086-755-83021966

<http://www.eemb.com>

Battery Structure

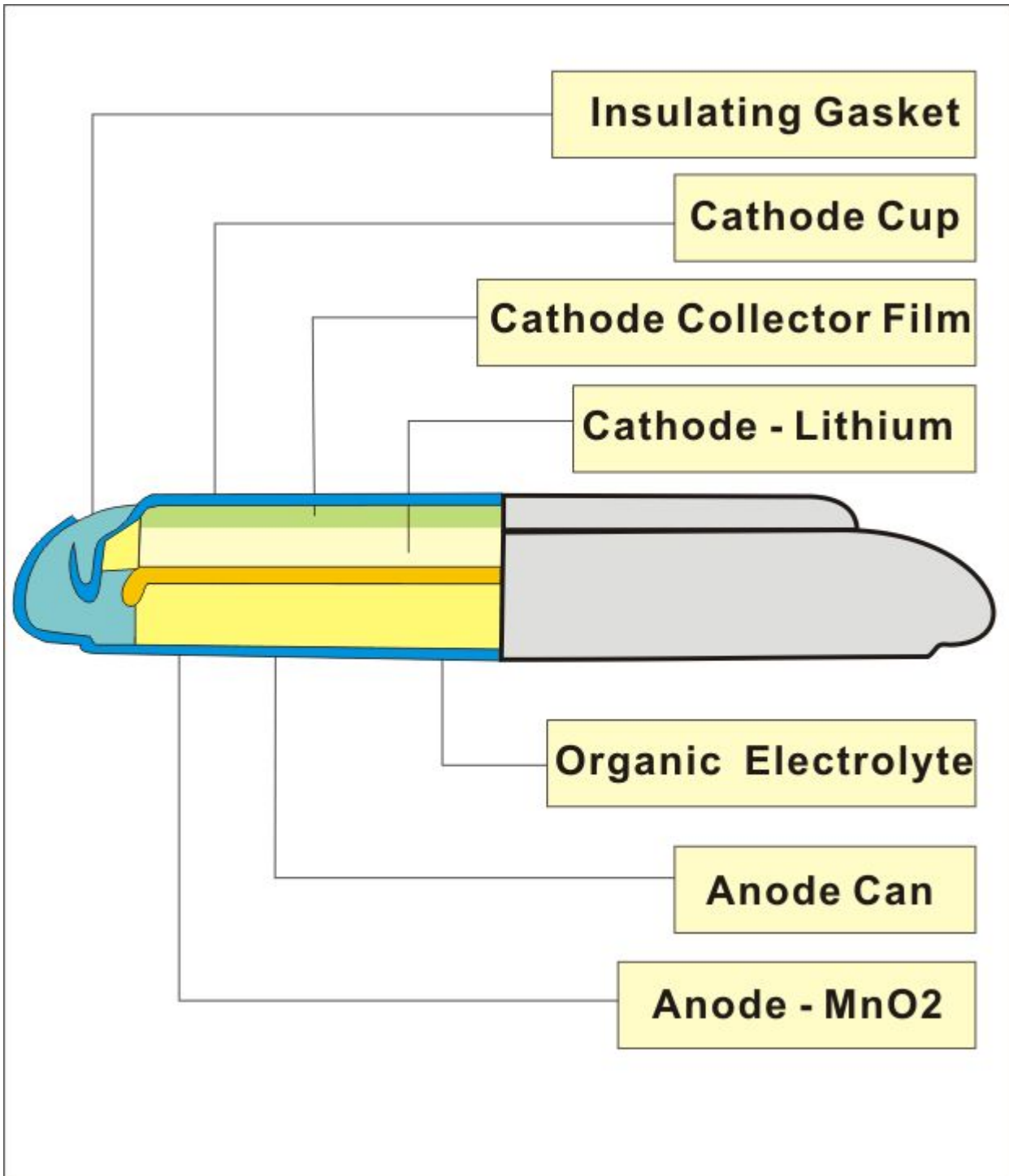

Catalog

Chapter	Content	Page
0	Catalog.....	3
1	Scope.....	4
2	Features and Applications	4
3	Battery Basic Characteristics.....	4
4	Battery Dimension	5
5	Appearance	5
6	Performance and Test Methods	5
7	Characteristics Curve	5~6
8	Memory Backup Circuit Design Suggestion	6
9	Matters Needing Attention	6~9

1. Scope

This product specification defines the requirements of the Lithium Manganese Dioxide battery supplied to the customer by EEMB Co., Ltd.

Manganese dioxide (MnO₂) is used for the active cathode material, and high voltage, high activity lithium metal for the anode material. Battery discharge reactions are as follows:

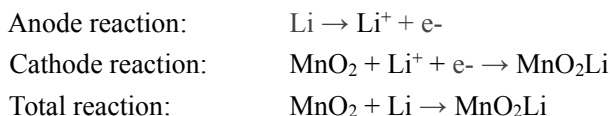

2. Features and Applications

Features:

- Light weight, high voltage and high energy density
- Excellent stable discharge characteristics
- Outstanding temperature characteristics
- Excellent leakage resistance
- Excellent long-term reliability

Applications:

- Watches
- Calculators
- PC notebooks
- Electronic keys
- Card-type radios
- IC cards
- Memory cards
- Medical equipment
- CMOS memory backup

3. Battery Basic Characteristics

No.	Item	Characteristics	Remarks
3.1	Model	CR1220	
3.2	Nominal capacity	40mAh	Standard discharge with load 15KΩ
3.3	Nominal voltage	3.0V	Standard discharge
3.4	Weight	Approx. 0.8g	Unit cell
3.5	Self-discharge rate	≤3%	Stored for 12 months at room temperature
3.6	Operating temperature	-20 ~ 60°C	
3.7	Storage temperature	0 ~ 35°C	

4. Dimension (Unit: mm)

Item	Specification
D	12.5 _{-0.3}
H	2.0 _{-0.2}
d	Max. 10.4
h	Max. 0.2

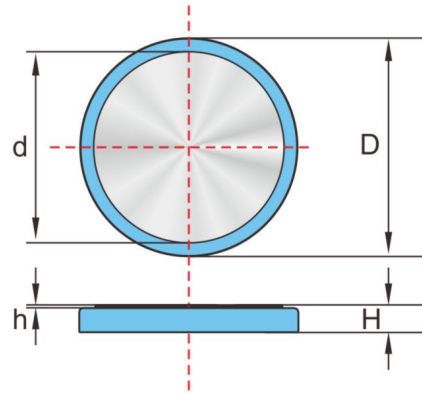

5. Appearance

It shall be free from any defects such as remarkable scratches, breaks, cracks, discoloration, leakage, or middle deformation.

6. Performance and Test Methods

Test condition: Temperature 20°C~25°C; Humidity 65±20%.

No	Item	Standard	Test Methods
6.1	Capacity	≥200h	Continuously discharge for 8 hours with load 15kΩ, till 2.0V end-voltage (for fresh battery only: within 3 months)
6.2	Vibration test	Characteristics keep stability	Put battery on the platform of the vibrations machine, start the machine and adjust the frequency form 10 times per minute to 15 times per minute. keep it running for an hour
6.3	Leakage at high temperature	Leakage rate≤0.6%	Stored under temperature (45°C) for 30 days
6.4	Over discharge Test	No leakage allowed	After 2.0V end-voltage, continuously discharged for 5 hours

7. Characteristics Curve

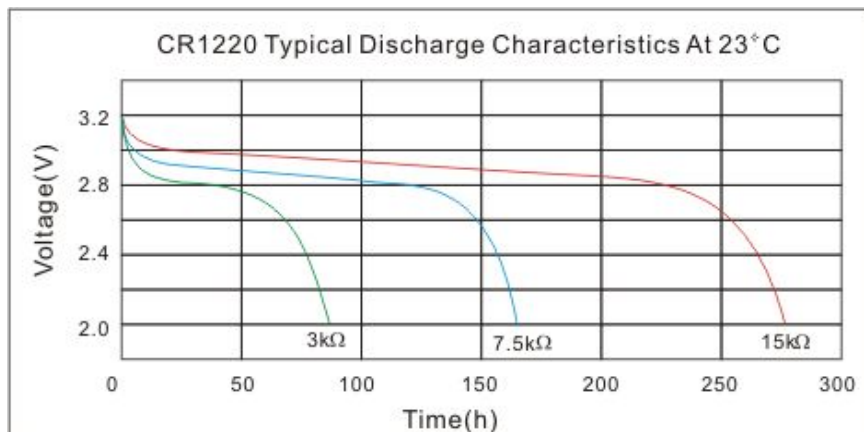

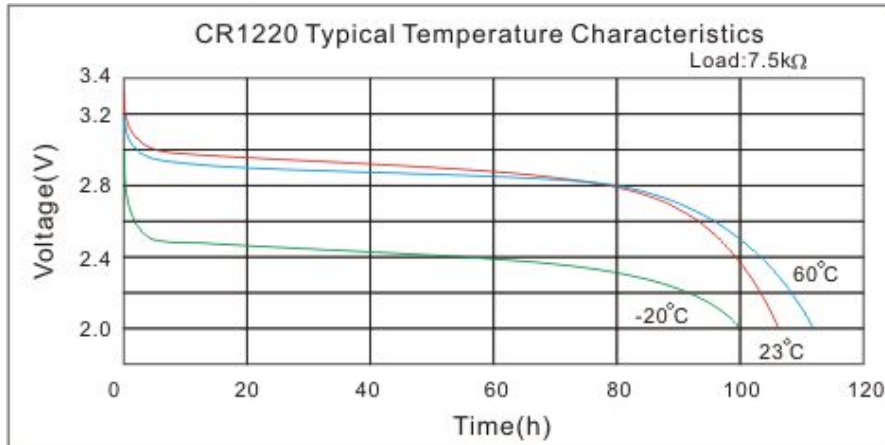

8. Memory Backup Circuit Design Suggestion

A primary lithium battery is not rechargeable, when used for memory backup in combination with another power source; current may flow into the battery from the other source. A protection diode and resistor into the circuit is needed to avoid battery charging or over discharging. Select a silicon diode or a diode with minimum leakage current, and design the circuit so that the amount of charging due to leakage current will not exceed 2% of the nominal battery capacity over the total period of use.

While used for memory backup, the following circuit shall be applied:

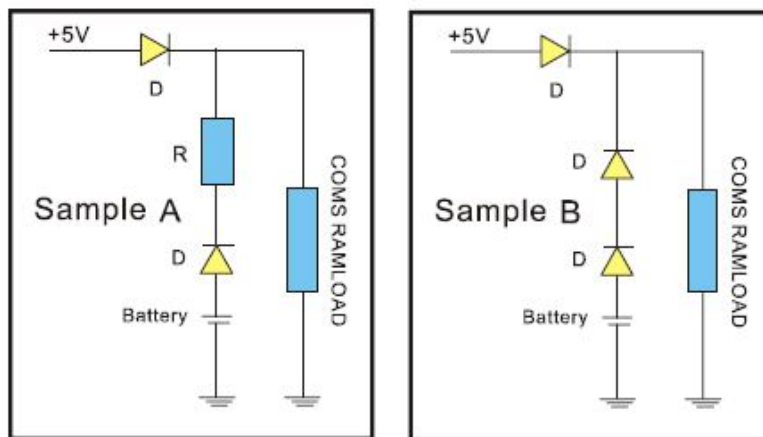

9. Matters Needing Attention

Strictly observes the following needing attention. EEMB will not be responsible for any accident occurred by handling outside of the precautions in this specification.

! Caution

- Use Nickel-plated iron or Nickel-plated stainless steel for the terminals that contact the battery.
- Make sure that terminal contact pressure is 50g minimum, for a stable contact.
- Keep the battery and contact terminal surfaces clean and free from moisture and foreign matter.
- Before inserting the battery, check the battery contact terminals to make sure they are normal, not bent or damaged. (Bent terminals may not make good contact with the battery or may cause short circuit.)

- When the batteries are piled up in a disorderly way, their positive and negative terminals may short-circuit, consuming some batteries while charging others, causing explosion.
- Lithium batteries that are almost exhausted can output a voltage that is almost the same as that of a new battery: Please does not judge a battery only with a Voltmeter. Do not mix batteries of different types and brands, or new and used batteries. We are well informed that battery pack should be assembled with single batteries of similar voltage, capacity and inner resistance.
- Lithium batteries need a period of time to recover their normal voltage after even a slight short circuit. Therefore, if the battery is short-circuited, wait an adequate long time for batteries to recover before measuring their electrical characteristics.
- Use a high impedance (1M or higher) voltmeter to measure battery voltage.
- Add fuse between negative and connector. Once short circuit, it will cut immediately and permanently.
- Do not contact terminals with conductive i.e. metal, goods. Keep batteries in non-conductive, i.e. plastic, trays.
- Reduce impact to insulation layer from vibration, but the dimension will enlarge.
- Battery characteristics vary with type and grade, even when batteries are the same size and shape. When replacing batteries with new ones, be sure to carefully check the symbols and numbers on them.

! Danger

- DO NOT recharge, short-circuit, disassemble, deform, heat or place the battery near a direct flame. This battery contains flammable materials such as lithium and organic solvent and performing any of the above actions could cause it to ignite explode or become damaged.
- DO NOT over-discharge the battery. In case the battery is over-discharged when connected with exterior power source or connected with other batteries in series, explosion may occur.
- Keep this battery out of the reach of children. If it is swallowed, contact a physician immediately.
- When storing a battery or throwing it away, be sure to cover it with tape. If the battery is contacted with other metal objects, it could cause fire or become damaged.

! Warning

- Thoroughly read the user's manual before use, inaccurate handling may cause leakage, heat, smoke, explosion, or fire, causing device trouble or injury.
- Insert the battery with the "+" and "-" ends correctly oriented.
- If the battery is used together with new batteries, do not use it with a different type battery.
- Do not solder the battery directly. Protect the welding point and connector.
- The battery should be preferably stored in dry and cool conditions. Avoid storing the battery in direct sunlight, or in excessively hot and humid place. Storage at high temperature must be avoided to preserve the battery life time.

! Storage and Mount

The cell should be preferably stored in dry and cool conditions.

+60°C, 120 days stored condition is the equivalent of 6 years at room temperature (+21°C).

Button lithium batteries need special method to avoid short-circuiting before and after they are installed. As short circuits tend to occur in the following cases, please take care when handling the batteries.

- **Overlapping Batteries**

A Button lithium battery is shaped as shown below. It has exposed positive and negative metallic surfaces with a thin cylindrical seal, called the gasket, in between.

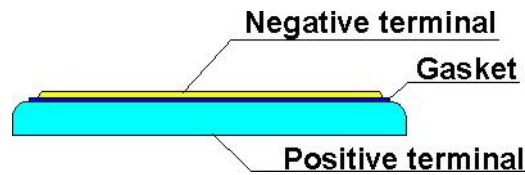

When batteries are overlapped or mixed together in a disorder way, their positive and negative terminals touch each other, causing short circuits.



- **Batteries put in a Metallic Container or on a Metallic Plate**

Similar to the overlapping battery problem, when batteries are put in a metallic container or on a metallic plate, their positive and negative terminals may short circuit through the conductive surface depending on the placement

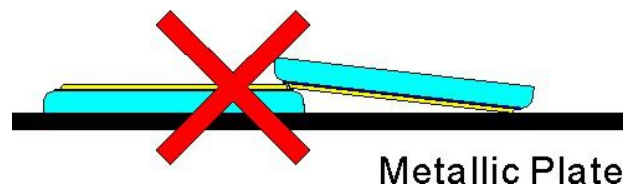

- **When a Battery is Held with Tweezers**

When held with a pair of metallic tweezers as shown below, the battery short-circuits through the tweezers



- **When Battery Lead Plates Touch Each Other**

When battery lead plates bend and touch each other or either terminal, the battery short-circuits.



- **Solder Bridges**

Solder may bridge between board conductors, short-circuiting and draining battery.

- **Short-circuited though Soldering Iron**

Similar to solder bridging, when the circuit board wiring is short-circuited by a soldering iron for an extended period, the battery is drained and consumed. Complete manual soldering within 5 seconds.

- **Shorts through Piled Circuit Board**

When circuit boards with batteries are piled on top of one another, their conductive traces may touch, and form a battery discharge circuit that consumes the battery's power.

- ***Discharge through Conductive Electrostatic Prevention Mats***

Conductive mats are widely used to prevent static electricity from destroying semiconductors. If a circuit board with a battery mounted in put on a conductive mat, the soldered conductors may touch the mat, providing a discharge path for the battery.

- ***Improper Battery Mounting Polarity***

When the battery's positive (+) and negative (-) terminals are backward with respect to the battery mounting's polarity marks, the battery may be discharged, depending on the type of electric circuit.

- ***Solder***

When the battery's lead plates are dipped in a molten solder bath, the battery is temporarily short-circuited. Therefore, complete dipping within 5 seconds.

EEMB reserves the final explanation. Please use battery strictly according to specification. EEMB will not be responsible for any inappropriate operation. EEMB keeps the right to change product specifications without previous notice. If any question, please consult with the manufacturer