

Fuse Inserter/Extractor with Cover Function for 10.3x38 mm Fuses in Clips, Patent Pending



ESO Fuse Inserter/Extractor (part of the delivery)  
 Order required accessories separately

See below:  
[Approvals and Compliances](#)

### Description

- Fuse inserter, extractor and cover in one component
- Patented, compact and cost-effective design
- Terminal marking optional possible
- Touch-safe according to IP20
- Captive fuse
- Designed for use with CSO clips only

### Applications

- All photovoltaic applications
- Inverters
- Battery charge controllers
- String fuses
- DC applications

### References

Mating cover to [AEO 10.3x38](#); [ASO 10.3x38](#); [CSO](#)

### Weblinks

[pdf data sheet](#), [html datasheet](#), [General Product Information](#), [Packaging details](#), [Distributor-Stock-Check](#), [Accessories](#), [Detailed request for product](#), [Microsite](#), [Video](#)

### Technical Data

Fuse-Link	10.3 x 38 mm	Contact Resistance	< 5mΩ at 100 mA
Mounting	Plug-in assembly		
Degree of Protection	IP 20		
Admissible Ambient Air Temp.	-40 °C to 85 °C		
Climatic Category	40/085/21 acc. to IEC 60068-1		
Material	Thermoplastic black UL 94V-0		
Unit Weight	9.2 g		
Storage Conditions	0 °C to 60 °C, max. 70% r.h.		
Product Marking	 Type, Safety Note		

### Approvals and Compliances

Detailed information on product approvals, code requirements, usage instructions and detailed test conditions can be looked up in [Details about Approvals](#)

SCHURTER products are designed for use in industrial environments. They have approvals from independent testing bodies according to national and international standards. Products with specific characteristics and requirements such as required in the automotive sector according to IATF 16949, medical technology according to ISO 13485 or in the aerospace industry can be offered exclusively with customer-specific, individual agreements by SCHURTER.

### Approvals



The approval mark is used by the testing authorities to certify compliance with the safety requirements placed on electronic products.

Approval Reference Type: ESO

Approval Logo	Certificates	Certification Body	Description
	<a href="#">UL Approvals</a>	UL	UL File Number: E39328

### Product standards

Product standards that are referenced

Organization	Design	Standard	Description
	Designed according to	UL 4248-1	Fuseholder general requirements
	Designed according to	CSA C22.2 no. 4248.1	Fuseholder general requirements





## Application standards

Application standards where the product can be used

Organization	Design	Standard	Description
	Designed for applications acc.	IEC/UL 62368-1	IEC 62368-1 includes the basic requirements for safety of audio, video, information technology and office equipment.

## Compliances

The product complies with following Guide Lines

Identification	Details	Initiator	Description
	<a href="#">CE declaration of conformity</a>	SCHURTER AG	The CE marking declares that the product complies with the applicable requirements laid down in the harmonisation of Community legislation on its affixing in accordance with EU Regulation 765/2008.
	RoHS	SCHURTER AG	Directive RoHS 2011/65/EU, Amendment (EU) 2015/863
	China RoHS	SCHURTER AG	The law SJ / T 11363-2006 (China RoHS) has been in force since 1 March 2007. It is similar to the EU directive RoHS.
	REACH	SCHURTER AG	On 1 June 2007, Regulation (EC) No 1907/2006 on the Registration, Evaluation, Authorization and Restriction of Chemicals 1 (abbreviated as "REACH") entered into force.

## Dimension [mm]

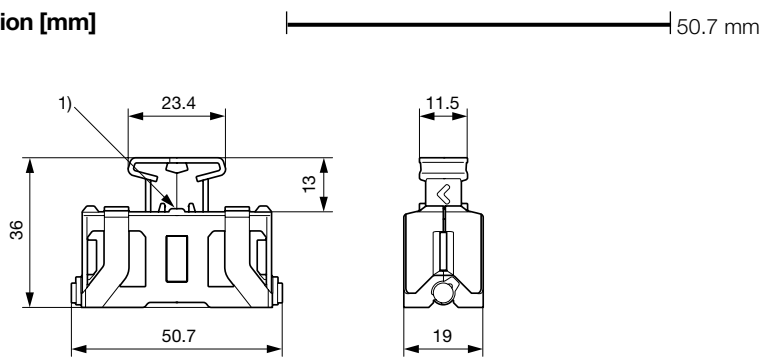

1) Position for optional terminal marking  
 (terminal block width: 5.2 mm, lettering field: 4.6x5.1 mm,  
 e.g. item 0818153 from Phoenix Contact)

## All Variants

Type	Packaging	Order Number
ESO 10.3x38	Bulk (50 pcs.)	0853.1250
ESO 10.3x38	Bulk (500 pcs.)	0853.1251

 Most Popular.

Availability for all products can be searched real-time: <https://www.schurter.com/en/Stock-Check/Stock-Check-SCHURTER>

## Required Accessory



### Description

**CSO**  
 Heavy Duty Fuse Clip, 10.3 x 38 / 10.3 x 85 mm, 1500 VAC/VDC, 32 A

10.3 x 38 / 10.3 x 85 mm	0751.0500
10.3 x 38 / 10.3 x 85 mm	0751.0501
10.3 x 38 / 10.3 x 85 mm	0751.0502
10.3 x 38 / 10.3 x 85 mm	0751.0503

...