

**AMIC**

**ASR8823**

***Ambient Light, Solar\_UV\_Index, IR and Proximity Sensor  
Preliminary with VCSEL Laser Diode Embedded and I2C digital interface***

---

**Document Title**

**Ambient Light, Solar\_UV\_Index, IR and Proximity Sensor with VCSEL Laser Diode Embedded and I2C digital interface**

**Revision History**

<b><u>Rev. No.</u></b>	<b><u>History</u></b>	<b><u>Issue Date</u></b>	<b><u>Remark</u></b>
0.0	Initial issue	July 30, 2018	Preliminary
0.1	Add 8-pin OCDFN (1.35mm x 2.45mm x 1.1mm) Package Information	December 19, 2018	



**Ambient Light, Solar\_UV\_Index, IR and Proximity Sensor**

**Preliminary**

**with VCSEL Laser Diode Embedded and I2C digital interface**

**General Description**

The ASR8823 is an integrated sensor of ambient light (ALS), Infrared light (IR), Solar\_UV\_Index (SUVI), and proximity sensing (PS). It provides innovative algorithms which can be friendly in application. ASR8823 is a perfect solution for light and PS sensing.

ASR8823 ALS/IR sensing offers ASC mode (Auto Scale Control) other than traditional manual mode. With ASC mode, ASR8823 can automatically adjust best measured resolution according to the detecting light intensity. User can measure the light data in accuracy by simply reading the data without any other setting. The ASC output data is in dynamic range of 16 bits with best 12 bits resolution.

ASR8823 can sense 3 light intensity ranges by ASC mode, high intensity (500K~7.6 lux), normal intensity (8K~0.1 lux), and low intensity (max 200 lux). To define these 3 sensing range, it just easily sets by ALS\_H (high intensity mode) and ALS\_L (low intensity mode) registers.

To get better resolution under 0.1 lux to 0.001 lux, the user can set ALS\_Gain value under ASC mode, or please contact AMIC for further application setting.

If the user wants to sense the higher light intensity (>400K lux), please contact AMIC for further application setting.

ASR8823 has an IR LD (Laser Diode) internally built in to do PS sensing and detects the presence of nearby object to avoid any physical contact. The driving current and pulse time of LD is widely optional according to the distance to be detected.

To cancel the PS optical crosstalk from overlay reflection, ASR8823 offers a PS Offset Cancellation function to easily cancel system internal reflection. After this cancellation, ASR8823 can still keep full 8 bits (256 steps) dynamic range of PS output, so that user has no need to modify the PS threshold setting.

**Applications**

- Notebook / Monitor
- Smart phone (touch screen disable and backlight control)
- LCD display (backlight control)
- Table PC
- PDA
- Presence Detection
- Industrial sensor

**Ordering Information**

Part Number	Temp. Range	Package & Size	Sensor to VCSEL LD Pitch	Packing	Lead-Free/RoHS
ASR8823-AA	-40°C ~ +85°C	8-pin (1.35mm x 2.45mm x 1.1mm)	1.778mm (small pitch)	Tape and Reel (3,000/reel)	Compliant

**Features**

- Ambient Light, Solar\_UV\_Index, IR and Proximity Sensor
  - Ambient Light (ALS) / IR Sensing
    - ALS closes to human-eye response (UV/IR rejection)
    - 3 ALS light ranges by ASC mode for various application
    - ALS dynamic rang up to 500K lux @high intensity mode
    - IR detecting spectrum in range of near Infrared
    - Unique 16bit ASC output
    - 16 bits ASC output by dynamic 12 bits ADC resolution
    - Programmable high/low threshold interrupt
  - Solar\_UV\_Index Sensing
    - CIE Erythemat Action Spectrum weighted
    - 11 indexes calculated by 8 bits dynamic output data
  - Proximity Sensing (PS)
    - IR VCSEL LD (Laser Diode) embedded
    - LD driving current 2.5/5/10/15 mA
    - Changeable PS pulse time from 0.05ms to 6.4ms
    - 8 bits effective output counts
    - Programmable high/low threshold interrupt
    - PS Offset to cancel crosstalk without dynamic range loss
  - On chip user trimming is capable for overlay correction
  - I2C digital Interface up to 400KHz with Interrupt Pin
  - Wait-time range from 0 to 7 seconds to save power
  - VDD = 2.5V to 3.6V
  - Temperature compensation : -40°C to +85°C
  - Low Power consumption I<sub>ALS</sub>~17uA, I<sub>PS+LD</sub>~30uA
- Package option
- 8-pin OCDFN (1.35mm x 2.45mm x 1.1mm)
  - All Pb-free (Lead-free) Products are RoHS2.0 Compliant

**Pin Assignment**

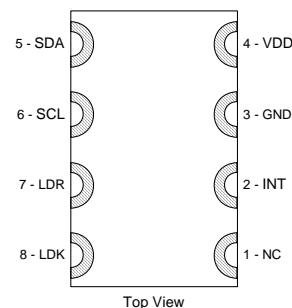

5	I2C Data	4	VDD Power
6	I2C Clock	3	Ground
7	LD Driving Port	2	Interrupt
8	LD Cathode ( - )	1	No Connection

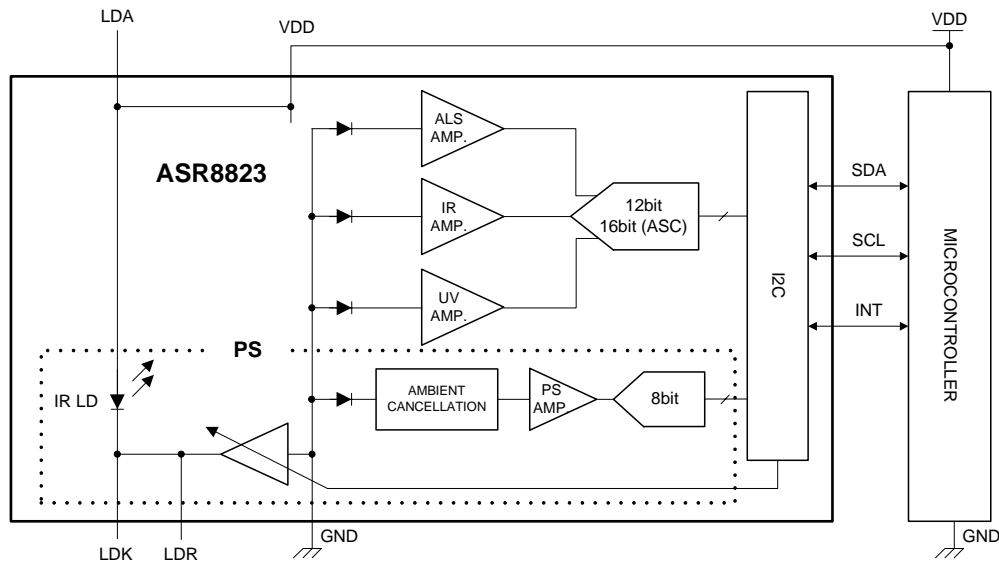
**Brief Block Diagram**

**Absolute Maximum Ratings\***

Storage Temperature (TSTG) .....	-40°C to + 100°C
Lead Temperature during Soldering (Note 1)	
D.C. Voltage on Any Pin to Ground Potential .....	-0.6V to $V_{CC} + 0.6V$
Transient Voltage (<20ns) on Any Pin to Ground Potential..	
.....	-2.0V to $V_{CC} + 2.0V$
Supply Voltage ( $V_{CC}$ ) .....	-0.6V to +4.0V
Electrostatic Discharge Voltage (Human Body model) (VESD) (Note 2) .....	-2000V to 2000V

**Notes:**

1. Compliant with JEDEC Std J-STD-020B (for small body, Sn-Pb or Pb assembly). For wave solder process, IC could meet 265°C, 5secs.
2. JEDEC Std JESD22-A114A (C1=100 pF, R1=1500Ω, R2=500Ω)

**\*Comments**

Stressing the device above the rating listed in the Absolute Maximum Ratings may cause permanent damage to the device. These are stress ratings only and operation of the device at these or any other conditions above those indicated in the operating sections of this specification is not implied. Exposure to Absolute Maximum Rating conditions for extended periods may affect device reliability.

**Electrical Characteristics**

Symbol	Parameter	Test Condition	Min.	Typ.	Max.	Unit
$V_{CC}$	Supply Voltage		2.5		3.6	V
$T_A$	Operating Temperature		-40		85	°C
$I_{LI}$	Input Leakage Current				± 2	μA
$I_{LO}$	Output Leakage Current				± 2	μA
$V_{IL}$	Input Low Voltage				0.55	V
$V_{IH}$	Input High Voltage		1.25			V
$V_{OL}$	Output Low Voltage	$I_{SINK} = 6mA$			0.4	V
$I_{CC1}$	Standby Current	No I2C activity		0.5	1	μA
$I_{CC2}$	Operating Current @Wait Time=60ms (without LD)	Light sensing only (ALS/IR/SUVI)		17	20	μA
		PS only (with $I_{LD} = 10mA$ )		27		μA
		PS and Light sensing ( $I_{LD} = 10mA$ )		30		μA

## Optical Characteristics

### ALS/IR Characteristics

Symbol	Parameter	Test Condition	Min.	Typ.	Max.	Unit
$\lambda_{P\_ALS}$	Peak Sensitivity Wavelength for ALS			550		nm
$\lambda_{P\_IR}$	Peak Sensitivity Wavelength for IR			850		nm
Data <sub>ALS_F</sub>	Full Scale ALS/IR Count		0		65535 (Note 1)	Count
Data <sub>ALS_O</sub>	Dark ALS/IR Count			0	3	Count
	ALS Detecting Light Intensity (ASC mode, ASC_Gain=x1)	High Intensity Mode (ALS_H=1, ALS_L=0)	~7.6		~500k	7.6 Lux/LSB
		Normal Mode (ALS_H=0, ALS_L=0)	~0.1		~8K	0.13 Lux/LSB
		Low Intensity Mode (ALS_H=0, ALS_L=1)	(Note 2)		~200	0.003m Lux/LSB
		ALS Detecting Light Intensity (Manual mode)	(Note 3)			~500k
-	ALS/IR Sensing Tolerance				±10	%

#### Notes:

1. The full ADC scale is 65535 counts under ASC mode, and 4095 counts under non ASC mode.
2. To get better resolution under 0.1 lux to 0.001 lux, the user can set ALS\_Gain value, or please contact AMIC for further application setting.
3. The manual mode ALS light intensity is defined by the value of ALS\_H/L, ALS\_Gain, and ALS\_IT. Please refer the page of ALS Lux Calculation

### IR LD Characteristics

Symbol	Parameter	Test Condition	Min.	Typ.	Max.	Unit
$\lambda_{P\_LD}$	Peak Wavelength			850		nm
$\Delta\lambda$	Spectrum Width, Half Power			1		nm
T <sub>R</sub>	Optical Rise Time			1		ns
T <sub>F</sub>	Optical Fall Time			1		ns

### PS Characteristics

Symbol	Parameter	Test Condition	Min.	Typ.	Max.	Unit
$\lambda_{P\_PS}$	Peak Sensitivity Wavelength	(Note)		850/550		nm
Data <sub>PS_F</sub>	Full Scale PS Count		0		255	Count
I <sub>LED/LD</sub>	LED/LD Sink Current		2.5		300	mA
t <sub>LED/LD_P</sub>	LED/LD Pulse Period		0.05		6.4	ms

#### Note:

The spectrum of LED/LD light source could be IR or Green selected by customer using user command 0x0D[3:0].

### Solar UV Index Characteristics

Symbol	Parameter	Test Condition	Min.	Typ.	Max.	Unit
Data <sub>SUVI_F</sub>	Full Scale Solar UV Index Count		0		255	Count
Data <sub>SUVI_O</sub>	Dark Solar UV Index Count			0	1	Count
-	Solar UV Index Sensing Tolerance				±15	%

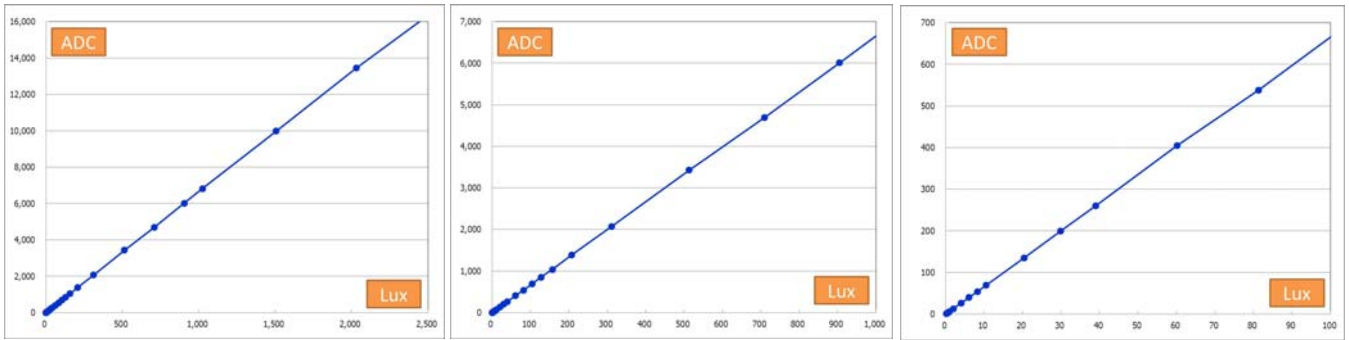
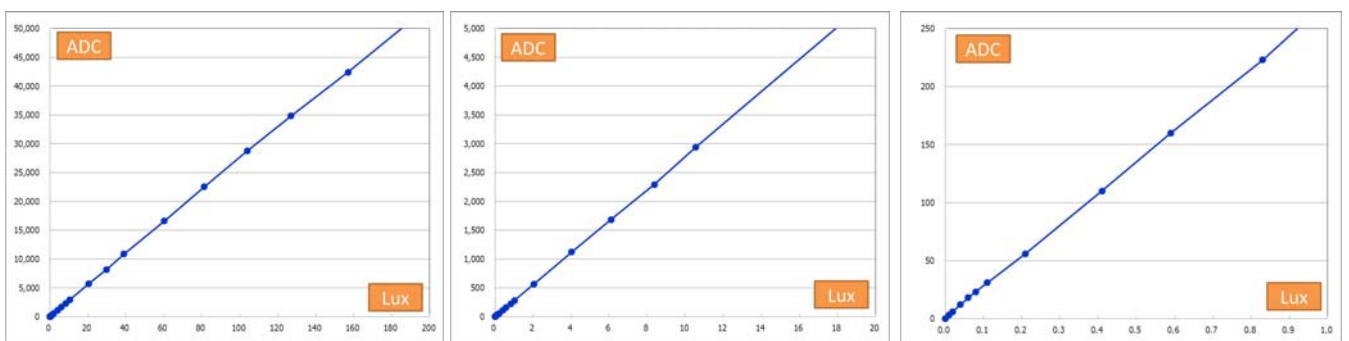

**ALS ADC count vs. Lux @ASC\_Normal mode with ASC\_Gain=x1**

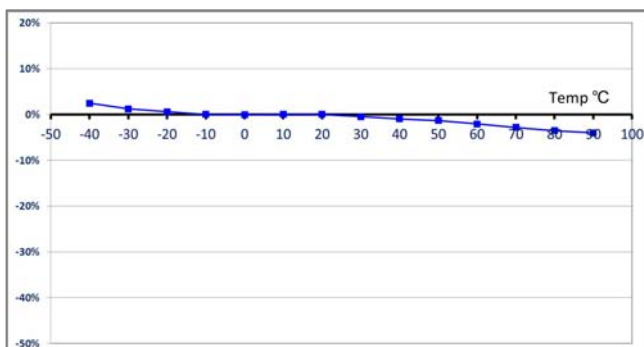
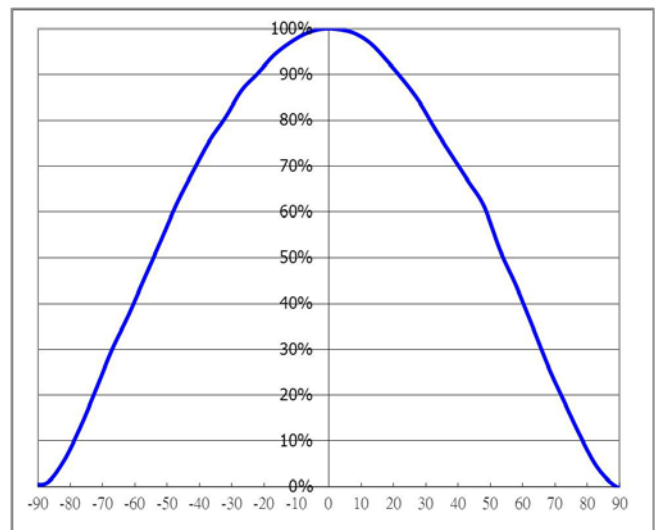
**ALS ADC count vs. Lux @ASC\_Low mode with ASC\_Gain=x1**

Note: To get better resolution under 0.1 lux to 0.001 lux, the user can set ALS\_Gain value, or please contact AMIC for further application setting.)

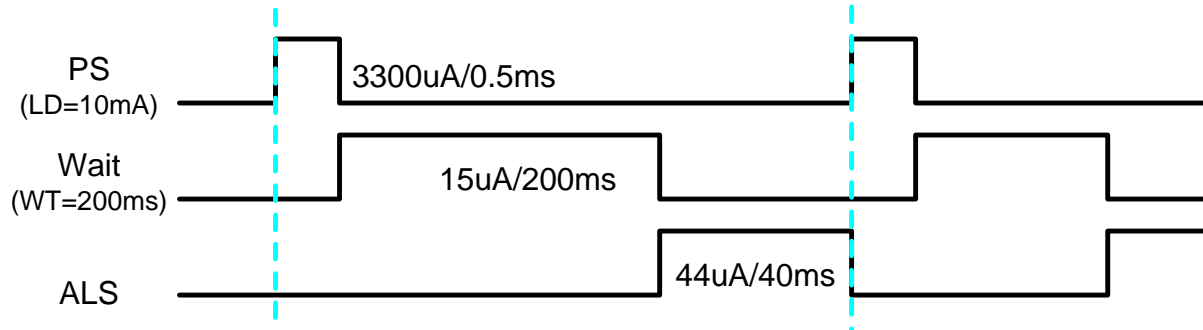

**ALS ADC count vs. Temperature**

**ALS View Angle**

### Power Management

Example: ALS Ts=40ms, PS (PS\_PT=Tps x1, LD=10mA included), Wait Time=200ms

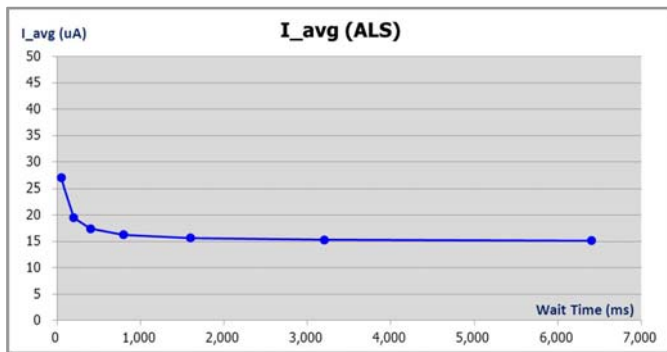

$$I_{avg} = (3300 \times 0.5 + 15 \times 200 + 44 \times 40) / (0.5 + 200 + 40) = 26 \mu A$$



ALS Average I<sub>CC2</sub>

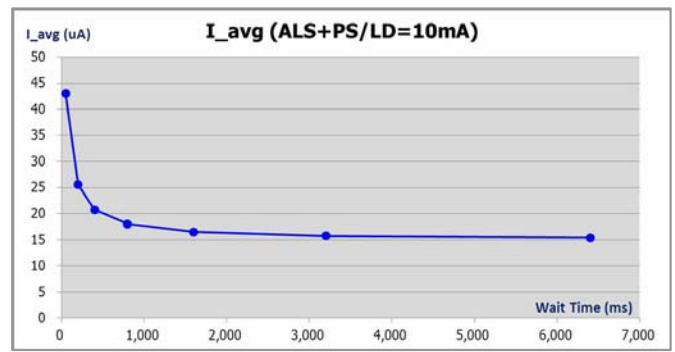

ALS+PS/LD=10mA Average I<sub>CC2</sub>

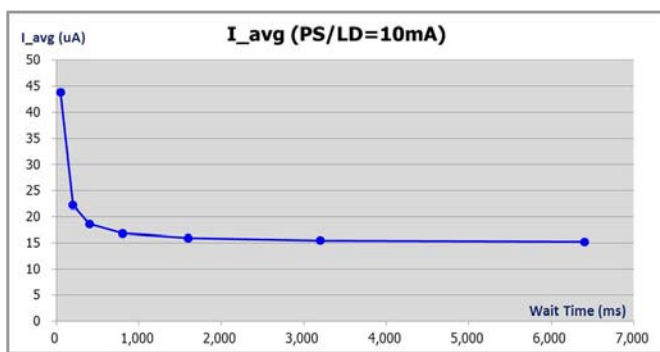

PS/LD=10mA Average I<sub>CC2</sub>

## Function Description

### Light Sensor

The ASR8823 converts light intensity of ambient light (ALS), Infrared light (IR) or Solar\_UV\_Index to digital signal through I2C interface by various photodiodes and ADC circuit. The I2C interface follows Philip™ I2C specification with an open drain active Interrupt pin.

The built-in ADC has 12 bits resolution. ASR8823 offers user flexibility selection in integration time or gain for different specific light detection range. If the light detection is in general purpose, the user can use ASC (Auto Scale Control) mode which can automatically adjust integration time and gain to the best resolution for various light intensity. The user has no need manually to set the integration time or gain. With ASC mode, the output data is in dynamic range of 16 bits. The Solar\_UV\_Index sensing adopts only ASC mode internally without manual mode option.

If the sensor will be under an overlay that is not 100% transmits to light source, the light data can be trimmed back on chip to the correct one. Please contact AMIC for more information on adjusting these offset.

### Proximity Sensor

Proximity sensing equips an internal IR VCSEL LD (Laser Diode) as light source to emit light, which is then viewed by the integrated light detector to measure the amount of reflected light when an object is in the light path. The amount of light detected from a reflected surface can then be used to determine an object's proximity to the sensor.

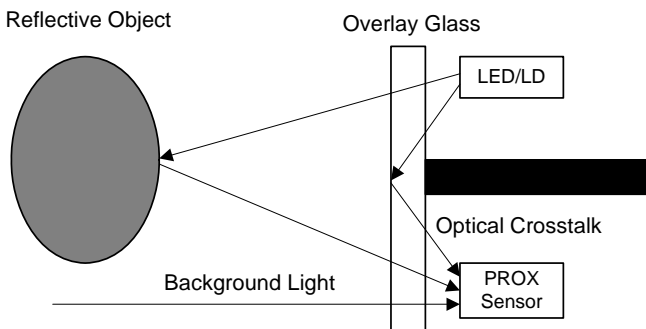

When the proximity sensing is enabled, the internal LD is driven by the built-in driver through the LDR pin. The driving current of LD is optional with range from 2.5mA to 15mA, and the pulse time is also changeable from 0.05ms to 6.4ms. These optional settings are according to the distance to be detected in application.

The ADC resolution of PS sensing is 8 bits with PS Offset function to cancel the PS optical crosstalk from overlay reflection. The PS offset value can be measured by PS\_OS function without any object in front of the overlay. After setting the offset value to 0xA5, the ASR8823 can cancel the system internal reflection but still keep full dynamic range of PS output with 8 bits (256 steps) resolution, and, the user has no need to modify PS threshold setting.

### Solar Ultraviolet (UV) Index

The Solar\_UV\_Index is a number linearly related to the intensity of sunlight reaching the earth and is weighted according to the CIE Erythral Action Spectrum. This weighting is a standardized measure of human skin's response to different wavelengths of sunlight from UVB to UVA. The UV Index has been standardized by the World Health Organization and includes a simplified consumer UV exposure level. ASR8823 can sense Solar\_UV\_Index with 8 bits output data, and user can multiply it by P\_SUVI to get Solar\_UV\_index.

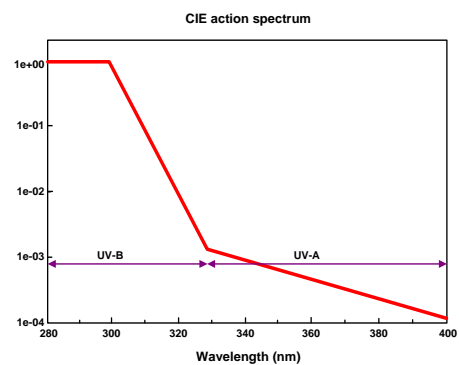

CIE Erythral Action Spectrum and UV Index Scale

### Interrupt Function

The ASR8823 has an intelligent interrupt scheme designed for light and PS sensing. The active low interrupt pin is an open drain pull-down configuration. The interrupt pin serves as an alarm or monitoring function to determine whether the ambient light or PS data exceeds the upper threshold or goes below the lower threshold. The user can also configure the persistency for the interrupt to eliminate any false triggers, such as noise or sudden spikes in ambient light conditions. The user uses 0x00[3,2] to identify which interrupt status, light sensing or PS one, is raised.

### System Operation State

The ASR8823 provides control of ambient light (ALS), IR light, Solar\_UV\_Index, proximity sensing (PS) detection, and power management through an internal state machine. After a power on reset, the device is in standby mode. As soon as any of light or PS sensing bit is enable, the device will move to the start state, and then it will continue through PS, UV, wait, and ALS/IR states.

If any Write command is executed during sensing in operation, then the device will interrupt the sensing process and move back to standby stage. It will then restart the process according to the new written conditions.

Regarding the enable setting of PS, UV and ALS/IR, customer can refer to the register 0x01 configuration.

### VDD Power-up and Power Supply Considerations

Upon power-up, a VDD slew rate of 0.5V/ms or greater is preferable. After power-up, or if the user's power supply is temporarily fluctuated by unknown noise causing system abnormal, AMIC recommends the user to issue a soft reset command 0x5B with data 0xB5, and then rewrite all registers to the desired values. If the user prefers a hardware reset method instead of soft reset, please set VDD = 0V for 1 second or more, and then power up at the required slew rate.

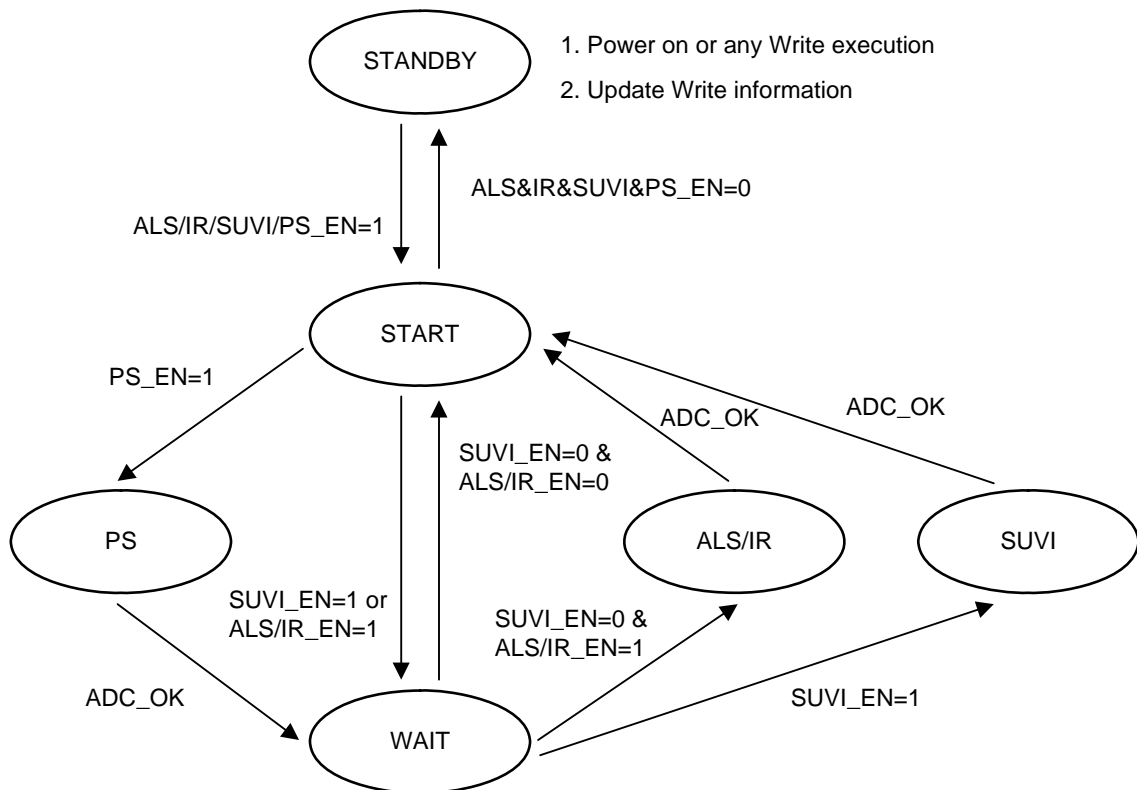

**Note:** When the SUVI sensing enables, all the other sensing will be disable, and their data will remain as previous sensing before SUVI was enable.



### I2C Protocol

The bus interface and control are accomplished through an I2C compatible, 2-wire serial interface consisting of a serial-data line (SDA) and a serial-clock line (SCL). SDA and SCL facilitate communication between the IC and the master at clock rate up to 400k Hz. The devices support the 7-bit I2C addressing protocol and 8-bit register address and data byte.

The I2C standard provides for three types of bus transaction: read, write, and a combined protocol.

During a write operation, after (slave\_address + R/W) byte, the first byte written is a register address followed by data

byte. If a read command is issued, the register address from the previous command will be used for data access. In a combined protocol, the first byte written is the register address followed by reading a series of data bytes.

ASR8823 slave address is 1001010X, which 0x94 is Write to ASR8823, and 0x95 is Read from ASR8823.

The I2C bus protocol follows Philip™ (now NXP company) I2C specification. For a complete description of I2C protocol, please refer to NXP I2C design specification.

### I2C Protocols

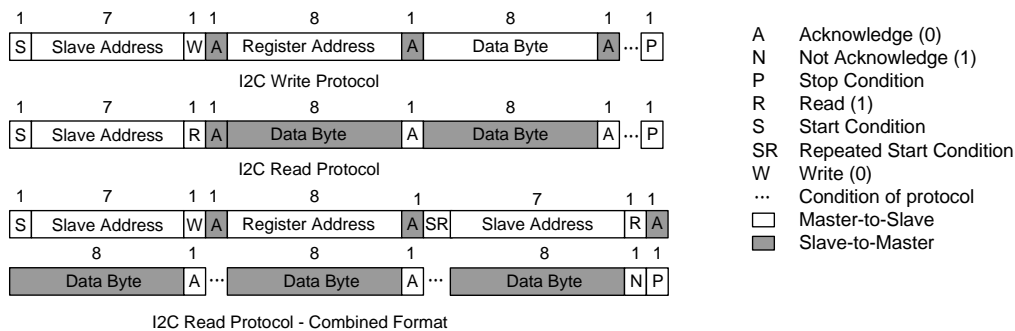

### Timing Diagrams

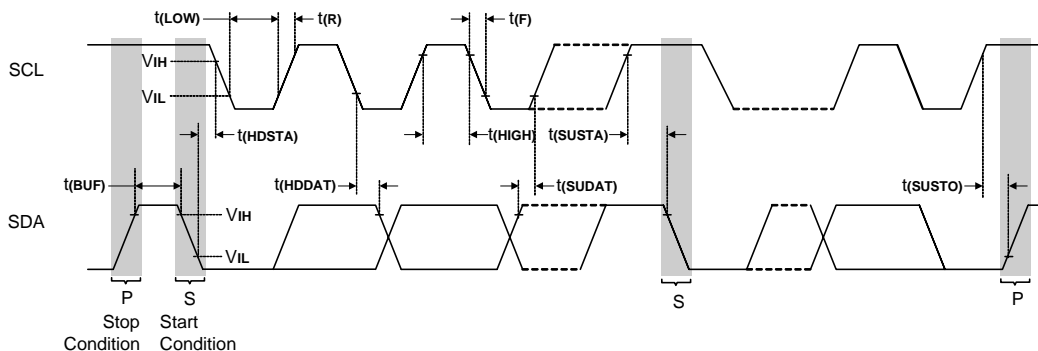

### I2C Bus Timing Characteristics

Symbol	Parameter	Min.	Typ.	Max.	Unit
$f_{(SCL)}$	Serial-Clock Frequency			400	KHz
$t_{(HIGH)}$	Clock High Period	0.6			$\mu$ s
$t_{(LOW)}$	Clock Low Period	1.3			$\mu$ s
$T_{(R)}$	Clock/Data Rise Time		100		ns
$T_{(F)}$	Clock/Data Fall Time		100		ns
$t_{(SUDAT)}$	Data Setup Time	100			ns
$t_{(HDDAT)}$	Data Hold Time	100			ns
$t_{(BUF)}$	Bus Free Time Between STOP and START	1.3			$\mu$ s
$t_{(HDSTA)}$	Hold Time (Repeated) Start Condition	0.6			$\mu$ s
$t_{(SUSTA)}$	Repeated Start Condition Setup Time	0.6			$\mu$ s
$t_{(SUSTO)}$	Stop Condition Setup Time	0.6			$\mu$ s
$t_{(SP)}$	Pulse Width of Suppressed Spike	0		50	ns

## ASR8823 Register Map

1. ASR8823 slave address is 1001010X, which 0x94 is Write to ASR8823, and 0x95 is Read from ASR8823
2. Register 0xA5 (PS Offset Trim\_A5) must be written once after power on for accurate PS sensing (Note).
3. Register 0x10 (Special Mode) is recommended to be written at least once after power on.

### System Registers

ADDR	R/W	Register Name	Bit7	Bit6	Bit5	Bit4	Bit3	Bit2	Bit1	Bit0	Default
0x5B	W	Soft Reset	Soft Reset, 0xB5								
0xE3	R	Device ID	Device ID, 0xA0								
0x10	R/W	Special Mode	0	0	ALS/IR#_Low	One Shot	ALS/IR_High	OVR_ENB	0	0	0x00

### Status Bits and Operation Command Registers

0x00	R	<b>State (Ready, Interrupt)</b>	AI/SUVI_RDY	L_OVR (Reserved)	---	---	ALS/IR_INTS	PS_INTS	---	---	0x00
0x01	R/W	Mode (Operation Mode)	WT [2:0]			ALS/IR_EN[1:0]		PS/SUVI_EN[1:0]		IR mode	0x00

### ALS/IR Registers

0x02	R/W	AI_CTRL (ALS/IR)	ASC#	ALS/IR_IT [2:0]		ALS/IR_GAIN [1:0]	ALS/IR_PRST [1:0]	0x00		
0x03	R	AI_D_L	ALS/IR Data Low Byte [7:0]							0x00
0x04	R	AI_D_H	ALS/IR Data High Byte [11:8], ASC mode [15:8]							0x00
0x05	R/W	AI_HTH_L	ALS/IR High Threshold - Low Byte [7:0]							0x00
0x06	R/W	AI_HTH_H	ALS/IR High Threshold - High Byte [11:8], ASC mode [15:8]							0x00
0x07	R/W	AI_LTH_L	ALS/IR Low Threshold - Low Byte [7:0]							0x00
0x08	R/W	AI_LTH_H	ALS/IR Low Threshold - High Byte [11:8], ASC mode [15:8]							0x00

### PS Registers

0x09	R/W	PS_CTRL (PS)	PS_OS	PS_PT [2:0]		PS_I [1:0]	PS_PRST [1:0]	0x00		
0x0A	R	PS_D	PS Data [7:0]							0x00
0x0B	R/W	PS_HTH	PS High Threshold [7:0]							0x00
0x0C	R/W	PS_LTH	PS Low Threshold [7:0]							0x00
0x0D	R/W	PS_DRIVE	PS Driving Current Magnification [3:0]			PS Light Type (IR/Green) [3:0]			0x00	

### Solar\_UV\_Index Registers

0x0E	R	SUVI_D	Solar UV Index Data [7:0]							0x00
------	---	--------	---------------------------	--	--	--	--	--	--	------

### Trim Registers

0xA0 ~ 0xA4/A7	R/W	Trim_A0 ~ Trim_A4/A7	(reserved)							
0xA5	R/W	Trim_A5	PS Offset [7:0]							0x28
0xA6	R/W	Trim_A6	PS_PT Trim [7:0]							0x28

### Note:

The best PS Offset setting value of 0xA5 is generated by executing PS function with PS\_OS register 0x09[7]=1. Please refer the "Application Note of ASR8xxx PS Offset Cancellation" to get this 0xA5 value.

## System Registers

ADDR	R/W	Register Name	Bit7	Bit6	Bit5	Bit4	Bit3	Bit2	Bit1	Bit0	Default
0x5B	W	Soft Reset	Soft Reset, 0xB5								
0xE3	R	Device ID	Device ID, 0xA0								
0x10	R/W	Special Mode	0	0	ALS/IR# _Low	One Shot	ALS/IR _High	OVR _ENB	0	0	0x00

### Register 0x10 (Special Mode)

Bit	Name	Function Description			
5	ALS/IR#_Low (with 0x10[3]=0)	Set the ALS/IR# sensing to low intensity range			
		0	ALS Normal intensity sensing (IR Low intensity sensing)	1	ALS Low intensity sensing (IR Normal intensity sensing)
4	One Shot	Set One Shot sensing only to each enable.			
		0	Repeat sensing	1	One Shot sensing
3	ALS/IR_High (with 0x10[5]=0 @ALS or 0x10[5]=1 @IR)	Set the ALS sensing to high intensity range			
		0	Normal intensity sensing	1	High intensity sensing
2	OVR_ENB (reserved)	ALS_OVR function (reserved)			
		0	ALS_OVR function enable	1	ALS_OVR function disable

## Status Bits and Operation Command Registers

### Register 0x00 (Data Ready & Interrupt Status Bits)

ADDR	R/W	Register Name	Bit7	Bit6	Bit5	Bit4	Bit3	Bit2	Bit1	Bit0	Default
0x00	R	<b>State (Ready, Interrupt)</b>	AI/SUVI _RDY	L_OVR (Reserved)	---	---	ALS/ IR _INTS	PS _INTS	---	---	0x00

Bit	Name	Function Description
7	AI/SUVI Ready Status	ALS/IR & SUVI Data Ready Status
		0 Data is NOT available to be used since power-on or last "clear".
		1 The data is available after enable. Once this bit is set, the only 2 ways to clear it to 0 are to read this register or set such sensing disable.
3:2	Interrupt Status	Interrupt Status Bits ([3]=ALS/IR_INTS, [2]=PS_INTS)
		0 No interrupt event has occurred since power-on or last "clear".
		1 The data has exceeded the designated window limits defined by Threshold registers, and persist timer is greater than the set Persist count. Once this bit is set, the only 2 ways to clear it to 0 are to read this register or set such sensing disable.

### Register 0x01 (Operation Control)

ADDR	R/W	Register Name	Bit7	Bit6	Bit5	Bit4	Bit3	Bit2	Bit1	Bit0	Default
0x01	R/W	<b>Mode (Operation Mode)</b>	WT [2:0]			ALS/IR_EN[1:0]		PS/SUVI _EN[1:0]		IR mode	0x00

Bit	Name	Function Description
7:5	Wait Time	Wait Time Setting for power consumption control, Tw=50ms
		000 Tw x1
		001 Tw x4
		010 Tw x8
		011 Tw x16
4:3	ALS/IR_Enable	ALS/IR Sensing enable
		00 ALS/IR sensing disable
		01 ALS sensing enable
2:1	PS/SUVI _Enable	PS/Solar_UV_Index Sensing enable (Note)
		00 PS/SUVI sensing disable
		01 PS sensing enable
0	IR mode	IR Mode
		0 ALS/PS/SUVI mode

#### Note:

When the SUVI sensing enables, all the other sensing will be disable, and their data will remain as previous sensing before SUVI was enable.

## ALS/IR Registers

### Register 0x02 (ALS/IR Command Set)

ADDR	R/W	Register Name	Bit7	Bit6	Bit5	Bit4	Bit3	Bit2	Bit1	Bit0	Default	
0x02	R/W	AI_CTRL (ALS/IR)	ASC#	ALS/IR_IT [2:0]			ALS/IR_Gain [1:0]		ALS/IR_PRST [1:0]		0x00	
Bit	Name	Function Description										
7	Auto Scale Control # (ASC mode)	Auto Scale Control of ALS/IR mode										
		0	ASC mode is active, ALS/IR_IT is automatically scaled by internal circuit, and ALS/IR Data and Hi/Lo threshold would be defined as 16 bits of [15:0]. The default ALS/IR_Gain value is x1 Gain, and it can be assigned higher to increase the sensitivity when the ASC ADC data is too low under measurement.									
		1	ALS/IR_IT and ALS/IR_Gain are controlled by register 0x02[6:4] and 0x02[3:2].									
6:4	ALS/IR_IT	ALS Integration Time Setting, Ts=5ms										
		000	Ts x1			100	Ts x16					
		001	Ts x2			101	Ts x32					
		010	Ts x4			110	Ts x64					
		011	Ts x8			111	Ts x128					
3:2	ALS/IR_Gain	ALS/IR Gain Setting for sensitivity range selection										
		00	x1 Gain			10	x4 Gain					
		01	x2 Gain			11	x8 Gain					
1:0	ALS/IR_PRST	ALS/IR Persist Setting for consecutive count of data value out of threshold range										
		00	1 count			10	4 counts					
		01	2 counts			11	8 counts					

### Register 0x03/04/05/06/07/08 (ALS/IR Data and Hi/Lo Threshold)

ADDR	R/W	Register Name	Function Description
0x03	R	AI_D_L	Read ALS/IR_Data 12 bits of [11:0]. If ASC mode is active, the data is auto scaled as 16 bits of [15:0].
0x04	R	AI_D_H	
0x05	R/W	AI_HTH_L	The ALS/IR High Threshold registers provide the values to be used as the high trigger point for interrupt generation. An interrupt is generated when the value of ALS/IR conversion is greater than the high threshold and persist count is reached. If ASC mode is active, the data is defined as 16 bits of [15:0].
0x06	R/W	AI_HTH_H	
0x07	R/W	AI_LTH_L	The ALS/IR Low Threshold registers provide the values to be used as the low trigger point for interrupt generation. An interrupt is generated when the value of ALS/IR conversion is lower than the low threshold and persist count is reached. If ASC mode is active, the data is defined as 16 bits of [15:0].
0x08	R/W	AI_LTH_H	

## PS Registers

### Register 0x09 (PS Command Set)

ADDR	R/W	Register Name	Bit7	Bit6	Bit5	Bit4	Bit3	Bit2	Bit1	Bit0	Default
0x09	R/W	<b>PS_CTRL (PS)</b>	PS_OS	PS_PT [2:0]			PS_I [1:0]		PS_PRST [1:0]		0x00

Bit	Name	Function Description	
7	PS_OS	PS Offset measurement: While this PS_OS measurement is under operation, NO any reflective object should be in front of the sensor or overlay. The measurement is set by PS mode enable with this bit = "1"; the value of PS_OS would be automatically written to register 0xA5, and the system needs to write this value to register 0xA5 (PS Offset) to cancel PS offset after each power-on (Note).	
6:4	PS_PT	PS Light Pulse Time Setting, Tps=0.05ms	
		000 Tps x1	100 Tps x16
		001 Tps x2	101 Tps x32
		010 Tps x4	110 Tps x64
		011 Tps x8	111 Tps x128
3:2	PS_I	PS Light Driving Current Setting, the current can be magnified as x1, x2, x10, x20 times by 0x0D[7:4].	
		00 2.5mA	01 5mA
1:0	PS_PRST	PS Persist Setting for consecutive count of data value out of threshold range	
		00 1 count	10 3 counts
		01 2 counts	11 4 counts

#### Note:

- For the initial use of ASR8823 without any overlay, it needs a first register values setting of 0xA5 (PS Offset) and 0xA6 (PS\_IT Trim). Below table are the reference values for user to set.
- For the first setup of ASR8823 in application or if any PS\_PT/I of 0x09[6:2] registers have been changed, the PS\_OS function must be executed again to get proper PS offset value of 0xA5, so that the cross talk can be fully cancelled when PS measurement. Please refer the "Application Note of ASR8xxx PS Offset Cancellation.

Part Number	LD to Sensor pitch ( $\lambda$ P_LD)	PS register set		PS condition
		0xA6	0xA5	
ASR8823-AA/XX	1.778mm (850nm)	0x1D	0x1C	@PS_PT=Tpsx1, PS_I=10mA

**Register 0x0A/0B/0C (PS Data and Hi/Lo Threshold)**

ADDR	R/W	Register Name	Function Description
0x0A	R	PS_D	Read the PS_Data 8 bits of [7:0].
0x0B	R/W	PS_HTH	The PS Hi_THreshold register provides the values to be used as the high trigger point for interrupt generation. An interrupt is generated when the value of proximity conversion is higher than the threshold and persist count is reached.
0x0C	R/W	PS_LTH	The PS Lo_THreshold register provides the values to be used as the low trigger point for interrupt generation. An interrupt is generated when the value of proximity conversion is lower than the threshold and persist count is reached.

**Register 0x0D (PS Driving Current Magnification and Light Type Selection)**

ADDR	R/W	Register Name	Bit7	Bit6	Bit5	Bit4	Bit3	Bit2	Bit1	Bit0	Default
0x0D	R/W	PS Light Source	PS Driving Current Magnification				PS Light Type (IR/Green)				0x00
Bit	Name	Function Description									
7:4	PS Driving Current Magnification	PS Driving Current Magnification of PS_I 0x09[3:2]									
		0000	PS_I current x1				0101	PS_I current x10			
		1000	PS_I current x2				1101	PS_I current x20			
3:0	PS Light Type	PS Light Source Type (IR/Green)									
		0000	Infrared (IR) Light				0101	Green Light (with ALS_L=0x10[5]=1)			

**Solar UV Index Registers**
**Register 0x0E (Solar\_UV\_Index Data)**

ADDR	R/W	Register Name	Function Description
0x0E	R	SUVI_D	Solar_UV_Index_Data [7:0]

## ALS Lux Calculation (value in decimal base)

### Parameter List:

**P\_Lux = 0.13** (ALS\_ADC\_Data to Lux\_value ratio)

**P\_ASC\_G = 2^(0x02[3:2])** (ASC mode Gain value)

**P\_Man = 2^(IT\_value + GAIN\_value - 4) = 2^(0x02[6:4] + 0x02[3:2] - 4)** (Manual mode value)

**P\_ALS\_L = 1** @ ALS\_L = 0x10[5] = 0

= **42** @ ALS\_L = 0x10[5] = 1 (ALS Low intensity sensing)

**P\_ALS\_H = 1** @ ALS\_H = 0x10[3] = 0

= **(0xA0[7:0]x64 + 1) ÷ (0xA0[7:0] + 1)** @ ALS\_H = 0x10[3] = 1 (ALS High intensity sensing)

### ALS Lux in ASC Mode (Auto Scale):

$$\text{ALS\_Lux} = \text{ALS\_ADC\_Data} \times (\text{P\_Lux} \div \text{P\_ASC\_G}) \times (\text{P\_ALS\_H} \div \text{P\_ALS\_L})$$

Example\_1 @ALS\_ADC\_Data=0AB8h=2744, ALS\_H/L=0x10[3,5]=[0,0], Gain=0x02[3:2]=[10]=2

$$\text{ALS\_Lux} = 2744 \times (0.13 / 2^2) \times 1 = 2744 \times 0.0325 = 89.18 \text{ lux}$$

Example\_2 @ALS\_ADC\_Data=1234h=4660, ALS\_H/L=0x10[3,5]=[1,0]

@Gain=0x02[3:2]=[00]=0, 0xA0[7:0]=0Ah=10

$$\text{ALS\_Lux} = 4660 \times (0.13 / 1) \times [(10 \times 64 + 1) \div (10 + 1) / 1] = 4660 \times 0.13 \times 58.27 = 35300 \text{ lux}$$

Example\_3 @ALS\_ADC\_Data=5678h=22136, ALS\_H/L=0x10[3,5]=[0,1], Gain=0x02[3:2]=[01]=1

$$\text{ALS\_Lux} = 22136 \times (0.13 / 2^1) \times (1 / 42) = 22136 \times 0.065 \times (1 / 42) = 34.26 \text{ lux}$$

### ALS Lux in Manual mode: (Sensing range set by ALS\_IT and ALS\_GAIN)

$$\text{ALS\_Lux} = \text{ALS\_ADC\_Data} \times (\text{P\_Lux} \div \text{P\_Man}) \times (\text{P\_ALS\_H} \div \text{P\_ALS\_L})$$

Example\_1 @ALS\_ADC\_Data=0234h=564, ALS\_H/L=0x10[3,5]=[0,0]

@IT=0x02[6:4]=[101]=5, Gain=0x02[3:2]=[11]=3

$$\text{ALS\_Lux} = 564 \times (0.13 / 2^{(5+3-4)}) \times 1 = 564 \times (0.13 \div 16) \times 1 = 4.583 \text{ lux}$$

Example\_2 @ALS\_ADC\_Data=0ABCh=2748, ALS\_H/L=0x10[3,5]=[1,0], 0xA0[7:0]=0Ah=10

@IT=0x02[6:4]=[010]=2, Gain=0x02[3:2]=[01]=1

$$\text{ALS\_Lux} = 2748 \times (0.13 / 2^{(2+1-4)}) \times [(10 \times 64 + 1) \div (10 + 1) / 1] = 2748 \times (0.13 / 0.5) \times 58.27 = 41633 \text{ lux}$$

Example\_3 @ALS\_ADC\_Data=0789h=1929, ALS\_H/L=0x10[3,5]=[0,1]

@IT=0x02[6:4]=[110]=6, Gain=0x02[3:2]=[00]=0

$$\text{ALS\_Lux} = 1929 \times (0.13 / 2^{(6+0-4)}) \times (1 / 42) = 1929 \times (0.13 / 4) \times (1 / 42) = 1.493 \text{ lux}$$



## Solar UV index (SUVI) Calculation

Please refer “ASR8xxx Application Note of Solar UV index (SUVI) Calculation”

## ALS Lux Calculation between Different Modes

For some applications like surveillance or Sun light measurement, High/Normal/Low Intensity Modes would be mixed use in between. AMIC offers an application note to

help users smoothly calculate the lux value when different modes are switched.

Please refer to the “Application Note of ASR8823 ALS Lux Calculation between Different Modes”

### Main Flow

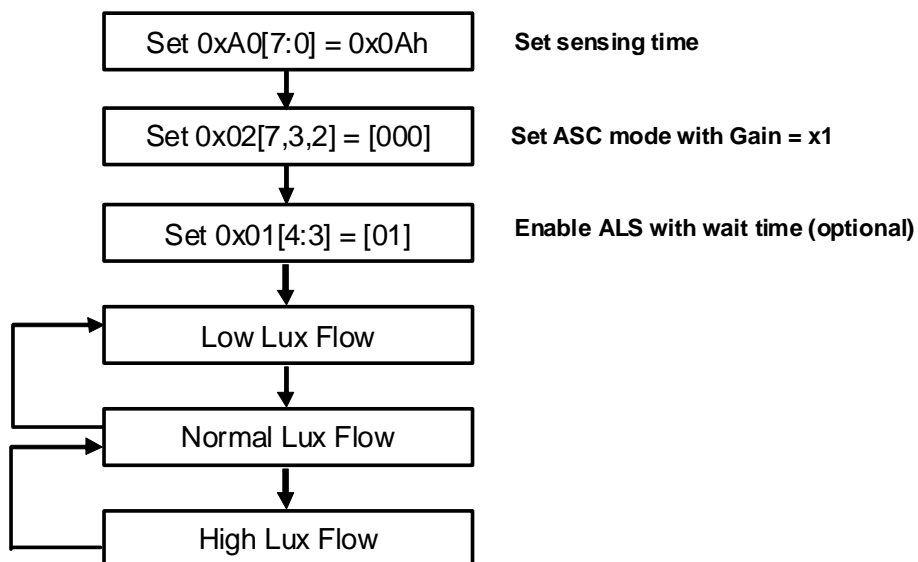

#### Notes:

1. Please skip the ASC ADC data of 65,535 (0xFFFF) to calculate the Lux value due to data overflow issue when different modes change in between.
2. When ASC\_Gain=x4 or x8, ASC ADC data of (511, 1023, 2047, 4095, 8191, 16383, 32767, 65535) should be skipped to calculate the Lux value due to data overflow issue caused by noise in ASC mode operation.
3. ASC\_Gain=x8 is not recommended to be used in ASC mode unless the measured light is too small to be detected.

## **ALS Measurement Calibration**

The overlay components in system, such as dark overlay windows, might have optical effect that affects accuracy of ALS measurement. System usually set a software calibration factor to correct back this effect. This device provides a hardware calibration method to get best

accuracy in this case. When this hardware calibration process is done, the user would get a new value of 0xA2[7:0]. After the system write the new value of 0xA2[7:0] to device each time after power on, the ALS\_ADC\_Data would be automatically adjusted to the correct one

**Please refer to the “Application Note of ASR8823 ALS Measurement Calibration Flow”**

## **PS Offset Cancellation**

When PS measurement operates, optical crosstalk offset would be naturally generated due to reflective components in application system such as overlay glass in front. This offset needs to be cancelled to get suitable dynamic range in measurement; otherwise it would lead to mistake in PS threshold check.

This device offers user an easy way to precisely compensate the PS offset. Through this process, user can record and cancel the offset data for the following PS measurement.

**Please refer the “Application Note of ASR8xxx PS Offset Cancellation” to process this PS offset cancellation.**

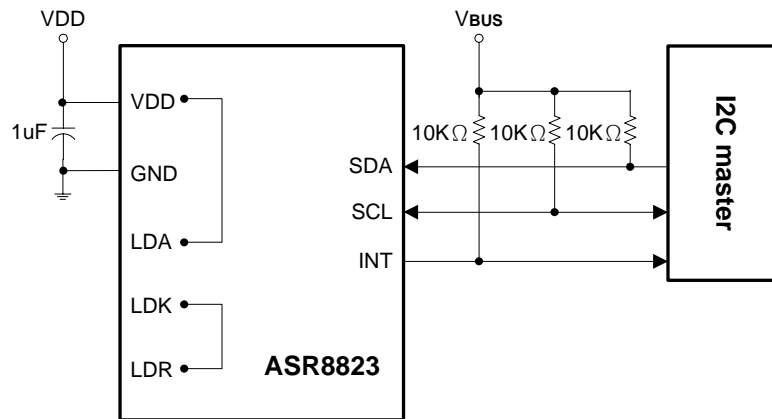
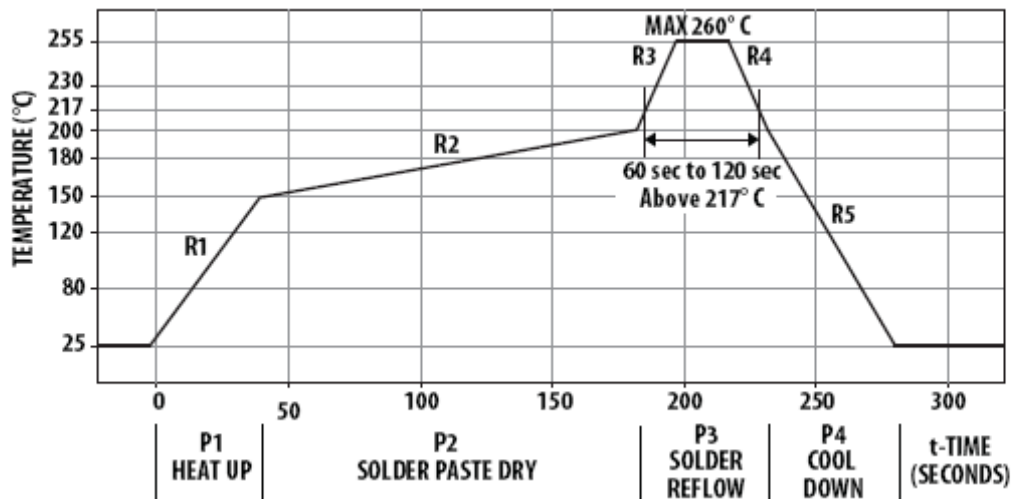
**Application Circuit Reference**

**Recommended Reflow Profile**

Process Zone	Symbol	$\Delta T$	Maximum $\Delta T/\Delta \text{time}$ or Duration
Heat Up	P1, R1	25°C to 150°C	3°C/s
Solder Paste Dry	P2, R2	150°C to 200°C	100s to 180s
Solder Reflow	P3, R3	200°C to 260°C	3°C/s
	P3, R4	260°C to 200°C	-6°C/s
Cool Down	P4, R5	200°C to 25°C	-6°C/s
Time maintained above liquid point, 217°C		> 217°C	60s to 120s
Peak Temperature		260°C	-
Time within 5°C of actual Peak Temperature		> 255°C	20s to 40s
Time 25°C to Peak Temperature		25°C to 260°C	8 mins

**Package Information**
**OCDFN 8L (1.35mm x 2.45mm x 1.1mm) Outline Dimensions**

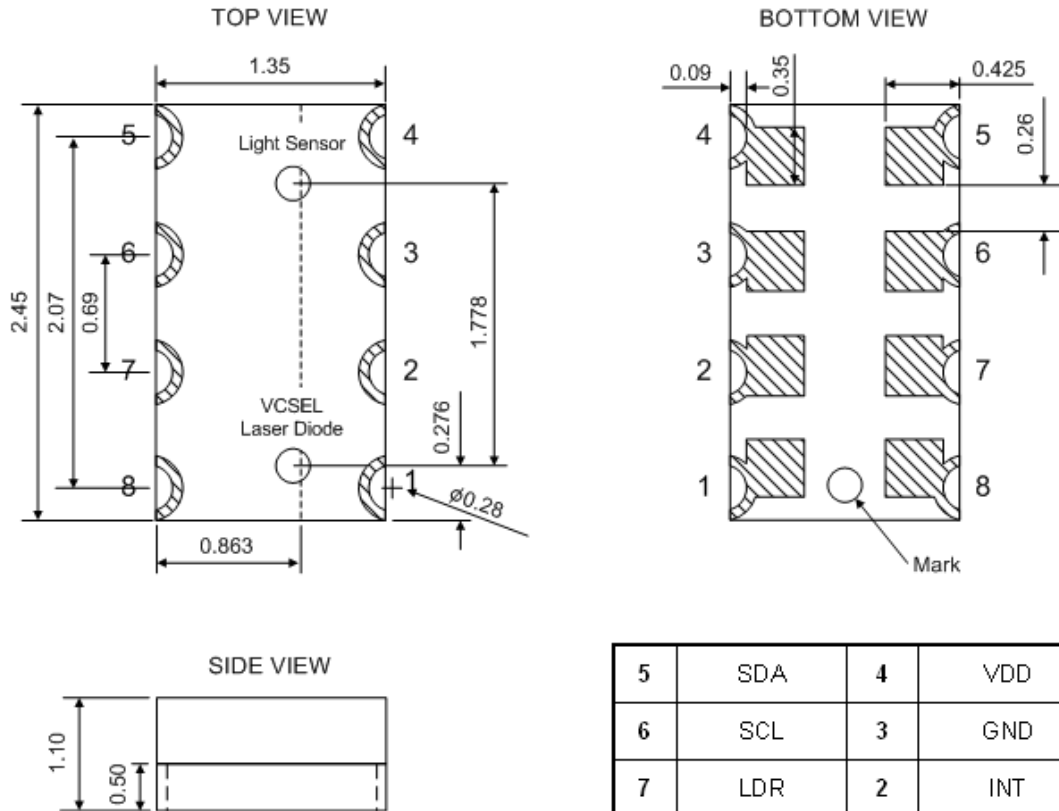
All linear dimensions are in mm

**PCB Pad Layout**

Suggested PCB pad layout guidelines for surface mount package are shown below.

