

Fast Recovery Rectifier

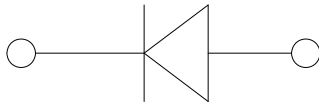
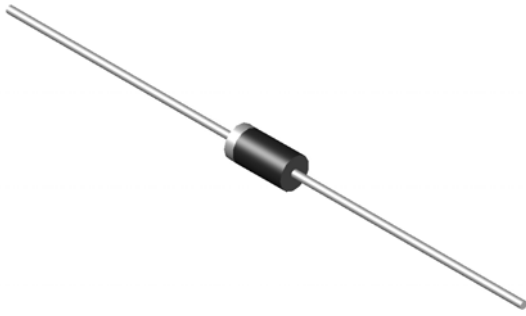

Features

- High efficiency
- High current capability
- High reliability
- High surge current capability
- Low power loss
- Glass passivated chip junction
- Solder dip 275 °C max. 7 s, per JESD 22-B106

Mechanical Data

- **Package:** DO-204AC(DO-15)
Molding compound meets UL 94 V-0 flammability rating, RoHS-compliant
- **Terminals:** Tin plated leads, solderable per J-STD-002 and JESD22-B102
- **Polarity:** Color band denotes cathode end

■ Maximum Ratings (Ta=25°C Unless otherwise specified)

PARAMETER	SYMBOL	UNIT	FR151	FR152	FR153	FR154	FR155	FR156	FR157
Device marking code			FR151	FR152	FR153	FR154	FR155	FR156	FR157
Maximum Repetitive Peak Reverse Voltage	V _{RRM}	V	50	100	200	400	600	800	1000
Maximum RMS Voltage	V _{RMS}	V	35	70	140	280	420	560	700
Maximum DC blocking Voltage	V _{DC}	V	50	100	200	400	600	800	1000
Average Forward Current @60Hz sine wave, Resistance load, Ta=75°C	I _{F(AV)}	A	1.5						
Forward Surge Current (Non-repetitive) @60Hz Half-sine wave, 1 cycle, Tj=25°C	I _{FSM}	A	50						
Forward Surge Current (Non-repetitive) @1ms, square wave, 1 cycle, Tj=25°C			100						
Current squared time @1ms≤t≤8.3ms Tj=25°C, Rating of per diode	I ² t	A ² s	10.375						
Typical junction capacitance @Measured at 1MHz and Applied Reverse Voltage of 4.0 V.D.C	C _j	pF	17				13	10	
Storage Temperature	T _{stg}	°C	-55 ~ +150						
Junction Temperature	T _j	°C	-55 ~ +150						

■ Electrical Characteristics (Ta=25°C Unless otherwise specified)

PARAMETER	SYMBOL	UNIT	TEST CONDITIONS	FR151	FR152	FR153	FR154	FR155	FR156	FR157
Maximum instantaneous forward voltage drop per diode	V _F	V	I _{FM} =1.5A	1.3						
Maximum DC reverse current at rated DC blocking voltage per diode	I _R	μA	T _j =25°C	2.5						
			T _j =125°C	100						
Maximum reverse recovery time	t _{rr}	ns	I _F =0.5A, I _R =1.0A, I _r =0.25A	150			250	500		



FR151 THRU FR157

■ Thermal Characteristics ($T_a=25^\circ\text{C}$ Unless otherwise specified)

PARAMETER	SYMBOL	UNIT	FR151	FR152	FR153	FR154	FR155	FR156	FR157
Typical Thermal Resistance	$R_{\theta J-A}$	$^\circ\text{C/W}$	50						

■ Ordering Information (Example)

PREFERED P/N	PACKAGE CODE	UNIT WEIGHT(g)	MINIMUM PACKAGE(pcs)	INNER BOX QUANTITY(pcs)	OUTER CARTON QUANTITY(pcs)	DELIVERY MODE
FR151 ~ FR157	D1	Approximate 0.38	3000	3000	30000	Tape
FR151 ~ FR157	C1	Approximate 0.38	500	500	25000	Bulk

■ Characteristics (Typical)

FIG.1: I_o - T_a Curve

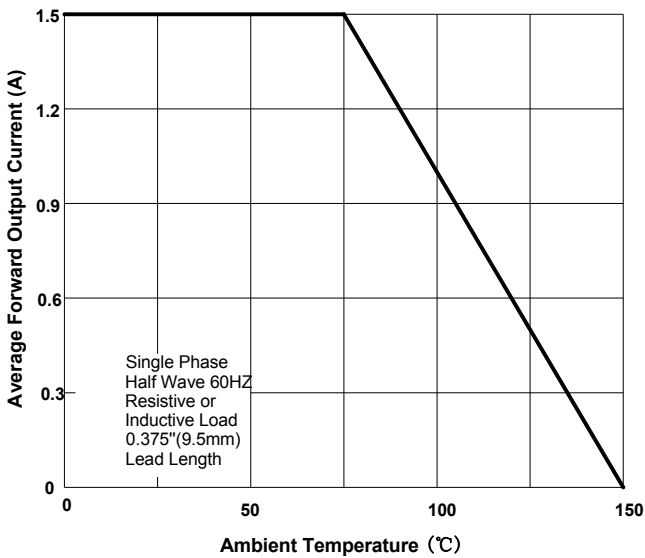

FIG.2: Forward Surge Current Capability

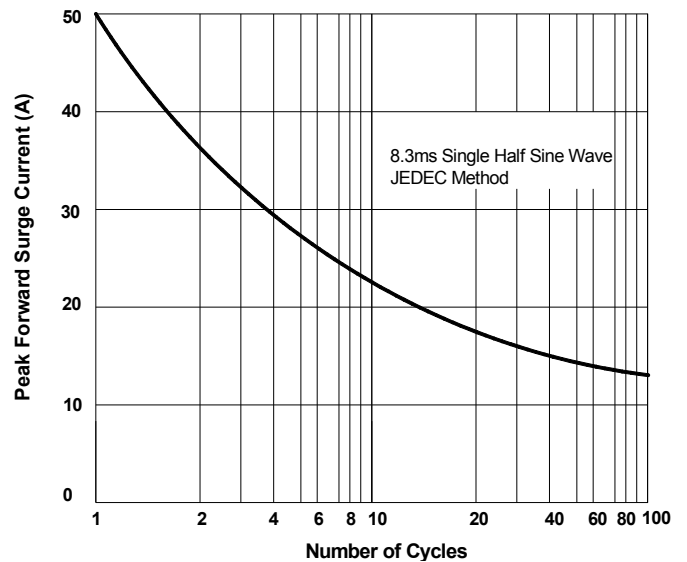

FIG.3: Forward Voltage

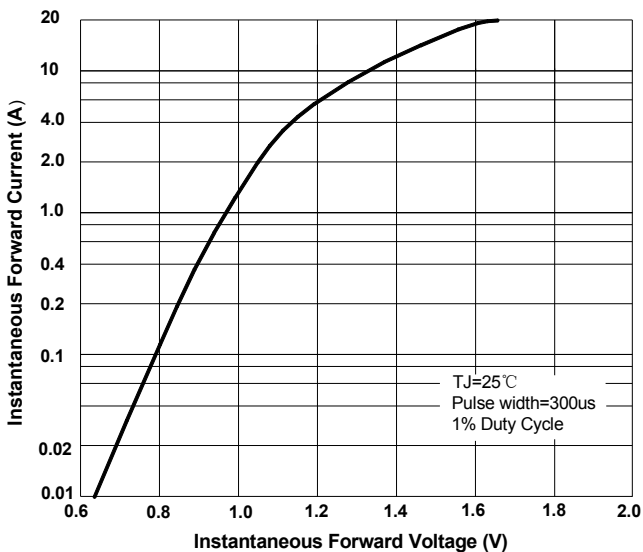

FIG.4: Typical Reverse Characteristics

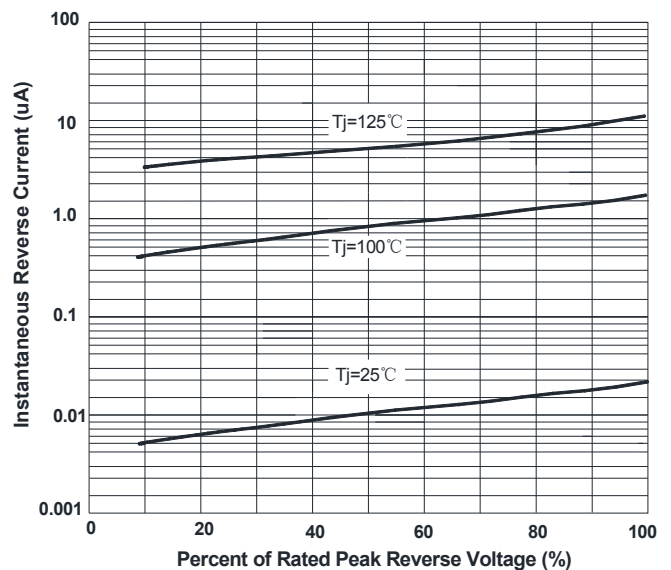
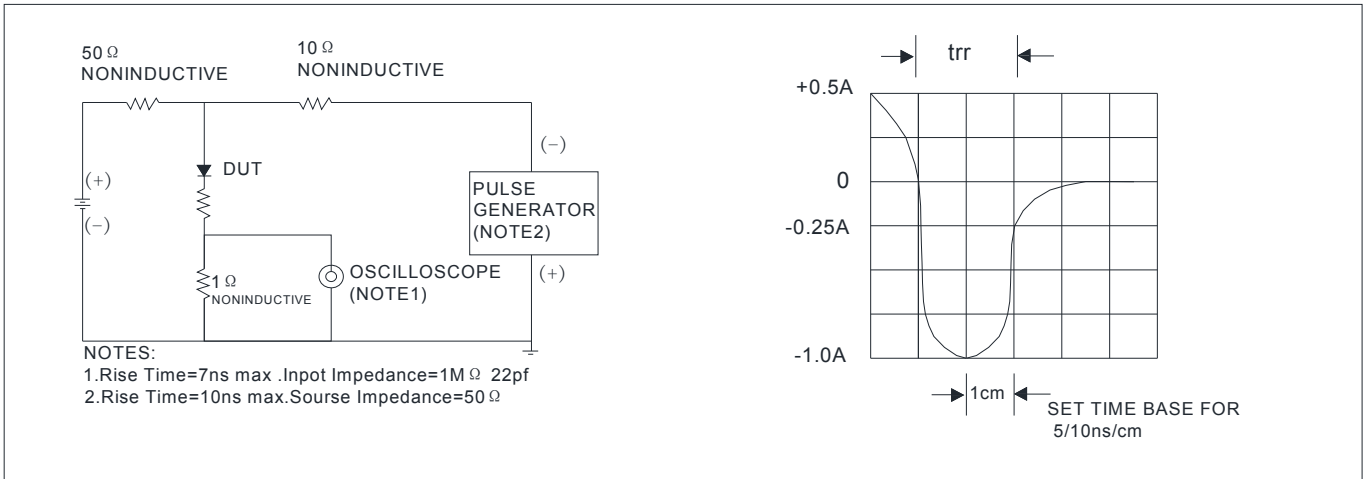
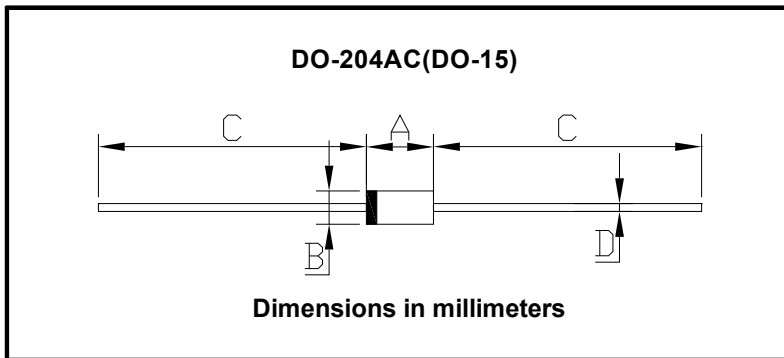

FIG.5: Diagram of circuit and Testing wave form of reverse recovery time



■ Outline Dimensions



DO-204AC(DO-15)		
Dim	Min	Max
A	5.80	7.60
B	2.60	3.60
C	25.4	/
D	0.70	0.90



Disclaimer

The information presented in this document is for reference only. Yangzhou Yangjie Electronic Technology Co., Ltd. reserves the right to make changes without notice for the specification of the products displayed herein to improve reliability, function or design or otherwise.

The product listed herein is designed to be used with ordinary electronic equipment or devices, and not designed to be used with equipment or devices which require high level of reliability and the malfunction of which would directly endanger human life (such as medical instruments, transportation equipment, aerospace machinery, nuclear-reactor controllers, fuel controllers and other safety devices), Yangjie or anyone on its behalf, assumes no responsibility or liability for any damages resulting from such improper use of sale.

This publication supersedes & replaces all information previously supplied. For additional information, please visit our website [http:// www.21yangjie.com](http://www.21yangjie.com) , or consult your nearest Yangjie's sales office for further assistance.