

<b>Shenzhen P&amp;O Technology Co.,Limited</b>	Rev No	Issued Date.	Page
	A	2021.12.07	1/18

Project Size.	4.3 inch	
Model No.	P043B018-CTP	
Samples No.		
Product type.	800xRGBx480 RGB mode	
Signature by customer:		
Prepared	Checked	Approved

## Shenzhen P&O Technology Co.,Limited

Email: [polcd@polcd.com](mailto:polcd@polcd.com)

Mobile: 86-136 0019 7172

## 1.0 GENERAL DESCRIPTION

### 1.1 Introduction

Display model P043B018-CTP is a (TM)Transmissive type color active matrix thin Film transistor (TFT) liquid crystal display (LCD) that uses amorphous silicon TFT as a switching device. This Model is composed of a TFT LCD panel, a driving circuit, a back light system. The resolution of a 4.3" contains 800<sub>RGB</sub>x480 dots and can display up to 262k colors.

Item	Specification	Unit
Screen Size	4.3" inch	Diagonal
Number of Pixel	800RGB(H)x480(V)	Pixels
Display area	95.04(H)x53.86(V)	mm
Pixel pitch	118.8(H)x112.2(V)	um
Outline Dimension	105.42x67.07x4.6	mm
Pixel arrangement	RGB Vertical Stripe	--
Display mode	Normally Black	--
Viewing Direction(eye)	ALL	--
Gray inversion direction	--	
Display Color	262k	--
Luminance(cd/m <sup>2</sup> )	280	nit
Contrast Ratio	1200:1	--
Surface treatment	--	--
Interface	RGB 24bit	
Back-light	LED Side-light type	--
Drive IC	ST7262E43	
Operation Temperature	-20~70	°C
Storage Temperature	-30~80	°C
Weight	--	g

### 1.2 Features

- n RGB 24bit interface.

### 1.3 Applications

- n MPOS Device.
- n Personal Navigation Device.
- n Other devices which require high quality displays.

## 2.0 INPUT INTERFACE PIN ASSIGNMENT

LCM FPC connector is used for electronics interface.

PinNo.	Symbol	Function
1	LEDK	LED back light(Cathode)
2	LEDA	LED back light(Anode)
3	GND	Ground
4	VCC	Power Supply. 2.8V
5-12	R0-R7	RGB Red data input
13-20	G0-G7	RGB green data input
21-28	B0-B7	RGB blue data input
29	GND	Ground
30	CLK	Dot clock signal for RGB interface operation
31	DISP	Display control / standby mode selection
32	HSYNC	Line synchronizing signal for RGB interface operation
33	VSYNC	Frame synchronizing signal for RGB interface operation
34	DE	Data enable signal for RGB interface operation
35	NC	NC
36	GND	Ground
37	XR	Touch the right end line
38	YD	Touch the lower line
39	XL	Touch the left line
40	YU	Touch the upper circuit

TP FPC connector is used for electronics interface

1	CTP_RST	Touch screen reset
2	VDD	Power Supply
3	GND	Ground
4	CTP_INT	Touch screen interrupt signal
5	CTP_SCL	Touch screen clock signal
6	CTP_SDA	Touch screen data signal

### 3.0 ABSOLUTE MAXIMUM RATINGS

#### 3.1 Electrical Absolute Rating

##### 3.1.1 TFT LCD Module

Item	Symbol	Min	Max	Unit	Note
Digital supply voltage	VDDI	-0.3	+4.6	V	GND=0
Analog supply voltage	VCI	-0.3	+4.6	V	GND=0
Logic Signal Input Level	VIN	-0.3	VDDI+0.5	V	GND=0

##### 3.1.2 Back-Light Unit

Item	Symbol	Min	Max	Unit	Note
LED current	I <sub>BL</sub>	30	40	mA	-
LED voltage	V <sub>BL</sub>	14	16	V	-

#### 3.2 Environment Absolute Rating

Item	Symbol	Min	Max	Unit	Note
Operating temperature	TOPR	-20	70	°C	-
Storage temperature	TSTG	-30	80	°C	-

Note:

Permanent damage may occur to the LCD module if beyond this specification.

## 4.0 OPTICAL CHARACTERISTICS

### 4.1 Optical specification

Item	Symbol	Condition	Min	Type	Max	Unit	Note
White luminance (Center)	Lv	$\Theta=0$ Normal Viewing Angle $I_{BL}=80mA$	--	300	--	cd/m <sup>2</sup>	(4)(5)(7)
Response time	Tr+Tf		--	30	--	ms	(6)
Contrast ratio	CR		--	1200	--	--	(2)
Color Chromaticity (CIE1931)	white		Wx	0.281	0.311	0.341	
		Wy	0.308	0.338	0.368		
Viewing Angle	Hor	$\Theta_L$	--	80	--		(1)
		$\Theta_R$	--	80	--		
	Ver	$\Theta_U$	--	80	--		
		$\Theta_D$	--	80	--		
Brightness uniformity	Avg	$\Theta=0$	80	90	--	%	(5)
Color Gamut	NTSC	$\Theta=0$	--	50	--	%	(5)
Optima View Direction	ALL						(1)

### 4.2 Measuring Condition

- n Measuring surrounding: dark room
- n LED current IL:40mA
- n Ambient temperature:  $25 \pm 2^\circ C$
- n 15min. warm-up time

### 4.3 Measuring Equipment

- n FPM520 of Westar Display technologies, INC., which utilized SR-3 for Chromaticity and BM-7 for other optical characteristics.
- n Measuring spot size: 20 ~ 21 mm

## Note (1) Definition of Viewing Angle

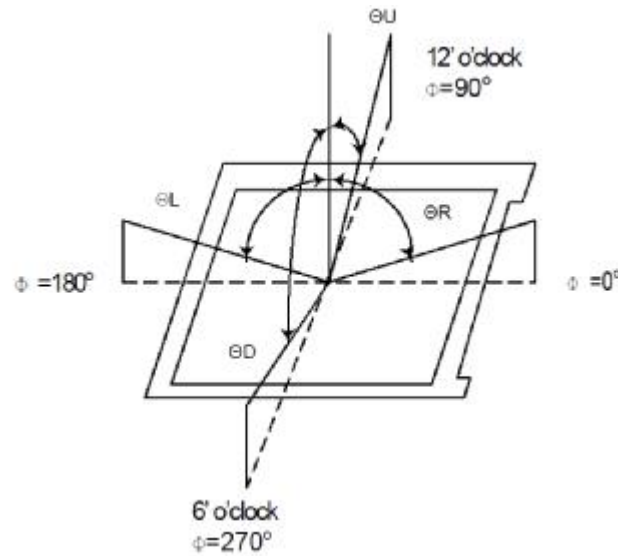

## Note (2) Definition of Contrast Ratio(CR):

Measured at the center point of panel

$$CR = \frac{\text{Luminance with all pixels white}}{\text{Luminance with all pixels black}}$$

## Note (3) Definition of Response Time: Sum of TR and TF

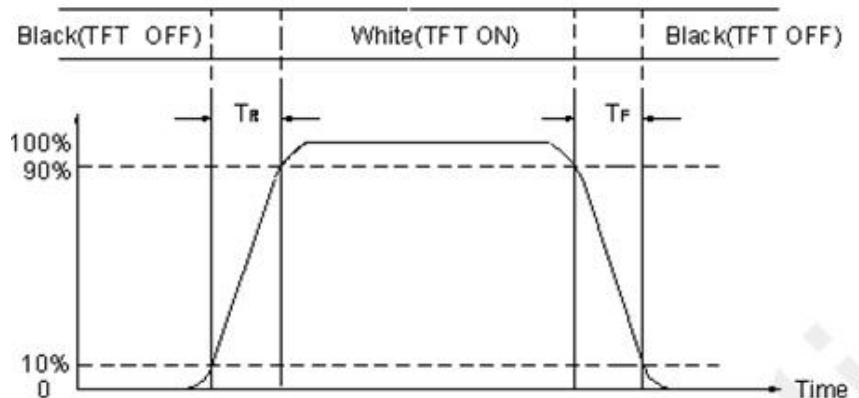

## Note (4) Definition of optical measurement setup

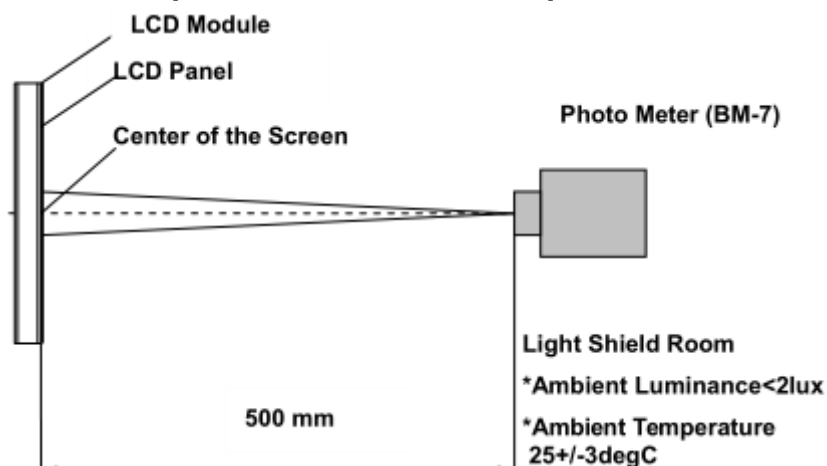

**Note (5) Definition of brightness uniformity**

The luminance uniformity is calculated by using following formula.

$$\Delta B_p = B_p (\text{Min.}) / B_p (\text{Max.}) \times 100 (\%)$$

$B_p (\text{Max.})$  = Maximum brightness in 9 measured spots

$B_p (\text{Min.})$  = Minimum brightness in 9 measured spots .

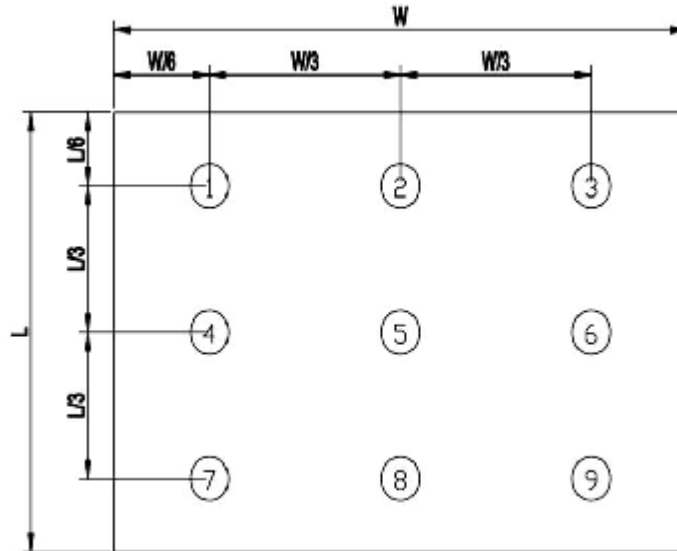

**Note (6) Definition of Color of CIE1931 Coordinate and NTSC Ratio.**

Color gamut:

$$S = \frac{\text{Area of RGB triangle}}{\text{Area of NTSC triangle}} \times 100\%$$

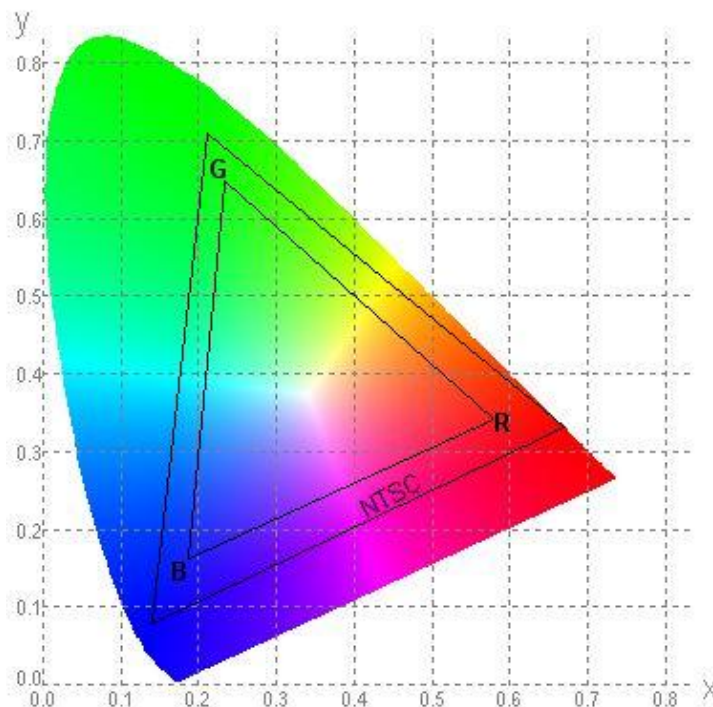

**Note (7) Measured the luminance of white state at center point.**

## 5.0 BLOCK DIAGRAM

### 5.1 TFT LCD Module

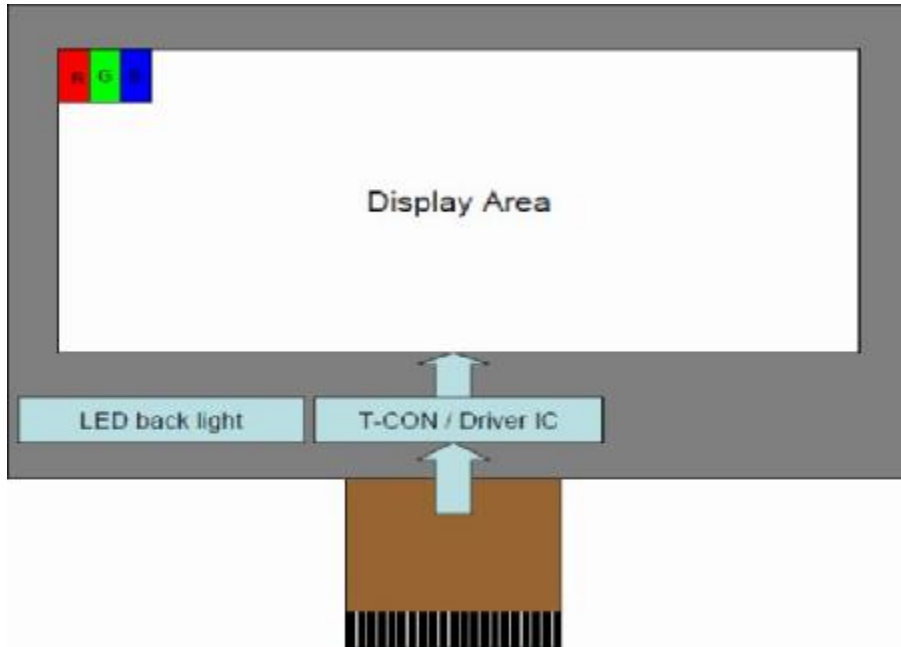

### 5.2 Pixel Format

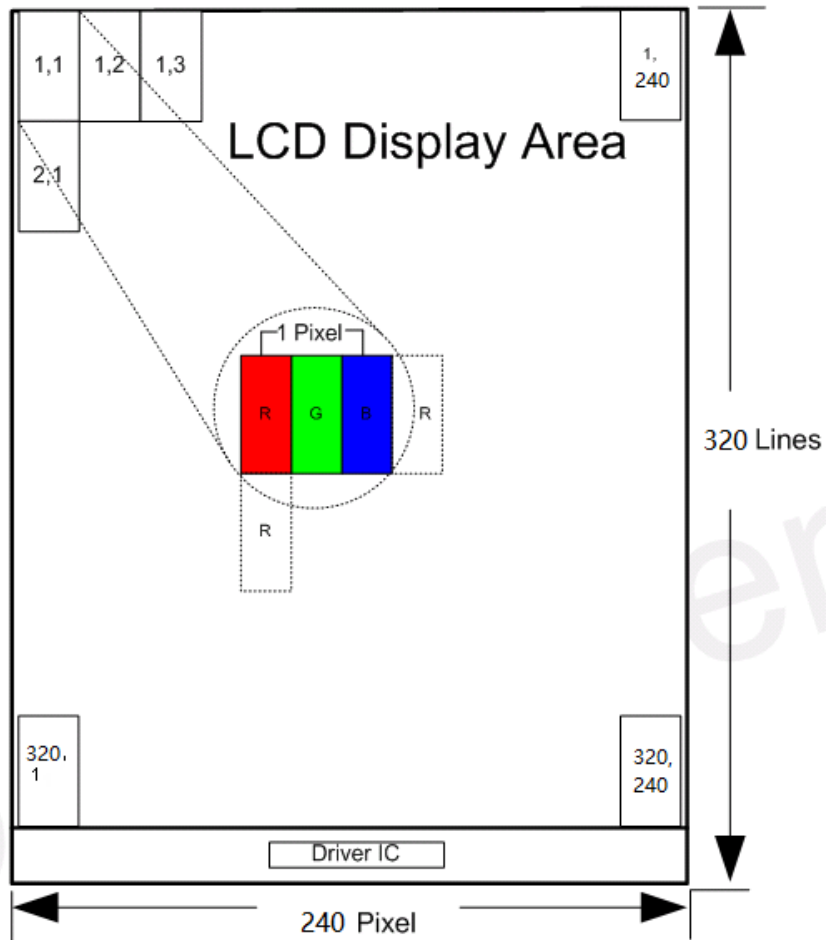



## 6.0 ELECTRICAL CHARACTERISTICS

### 6.1 TFT LCD Module

Item	Symbol	Min.	Typ.	Max.	Unit	Remark
Analog supply voltage	VDD	2.4	2.8	3.3	V	
Digital supply voltage	VDDI	1.65	1.8	3.3		
Input signal Voltage	VIH	0.7VDDI	-	VDDI	V	
	VIL	GND	-	0.3VDDI	V	

### 6.2 Back-Light Unit

The backlight system is an edge-lighting type with 10 LED Dies.

The characteristics of the LED are shown in the following tables.

Item	Symbol	Min	Typ	Max	Unit	Note
LED current	IL	-	30	40	mA	(2)
LED voltage	VL	-	14	16	V	
Operating LED life time	Hr	-	5000	5500	Hour	(1)(2)

Note (1) LED life time (Hr) can be defined as the time in which it continues to operate under the condition:  $T_a=25\pm 3\text{ }^\circ\text{C}$ , typical IL value indicated in the above table until the brightness becomes less than 50%.

Note (2) The “LED life time” is defined as the module brightness decrease to 50% original brightness at  $T_a=25^\circ\text{C}$  and  $I_L=80\text{mA}$ . The LED lifetime could be decreased if operating  $I_L$  is larger than 100mA. The constant current driving method is suggested.

Note (3) Suggested schematic of LED backlight driver

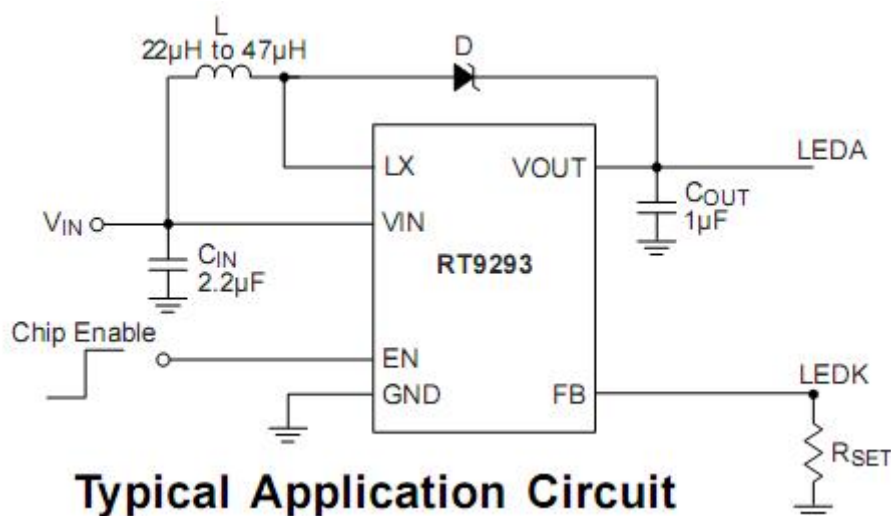

### 6.3 Interface Characteristics

8080 Series RGB Interface Characteristics: 24-bit Bus

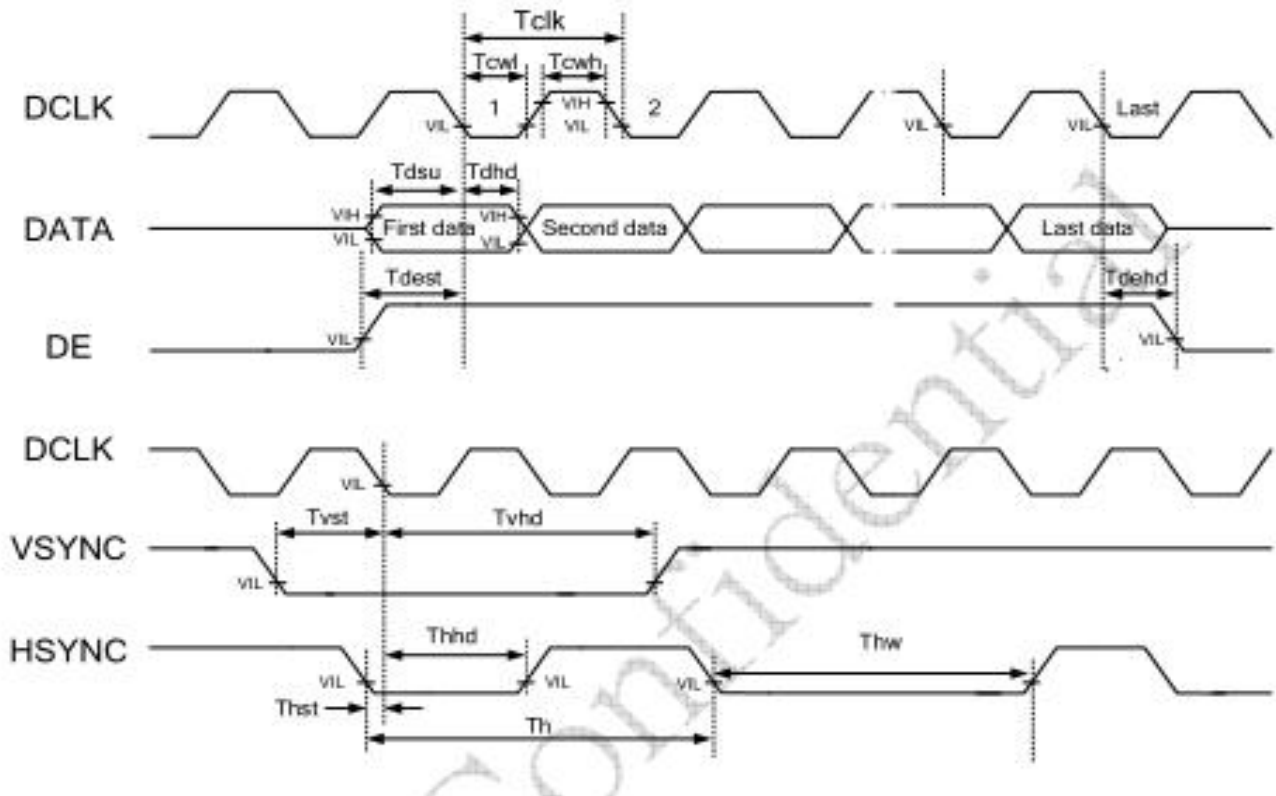

#### 10.1.1 Parallel 24-bit RGB Timing Table

Item	Symbol	Min.	Typ.	Max.	Unit	Remark	
DCLK Frequency	Fclk	8	9	12	MHz		
DCLK Period	Tclk	83	111	125	ns		
HSYNC	Period Time	Th	485	531	598	DCLK	
	Display Period	Thdisp	-	480	-	DCLK	
	Back Porch	Thbp	3	43	43	DCLK	By H_Blanking setting
	Front Porch	Thfp	2	8	75	DCLK	
	Pulse Width	Thw	2	4	75	DCLK	
VSYNC	Period Time	Tv	276	292	321	H	
	Display Period	Tvdisp	-	272	-	H	
	Back Porch	Tvbp	2	12	12	H	By V_Blanking setting
	Front Porch	Tvfp	2	8	37	H	
	Pulse Width	Tvw	2	4	37	H	

Note: It is necessary to keep Tvbp =12 and Thbp =43 in sync mode. DE mode is unnecessary to keep it.

## 7.0 Reliability conditions

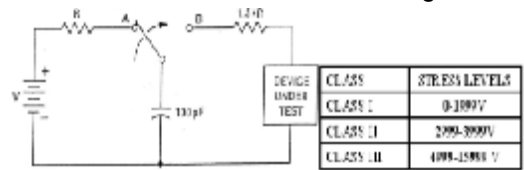
NO	Item	Conditions	Notes								
1	High Temperature Storage	Ta=80°C ± 2°C, 72hrs									
2	Low Temperature Storage	Ta=-30°C ± 2°C, 72hrs									
3	High Temperature Operation	Ta=70°C ± 2°C, 72hrs(Operation state)									
4	Low Temperature Operation	Ta=-20°C ± 2°C, 72hrs(Operation state)									
5	High Temperature and High Humidity (Storage)	Ta=+60°C, 90%RH, 72hrs									
6	Thermal Cycling Test (non operation)	-20°C (30min) → +70°C (30min), 10cycles									
7	Electro static Discharge	<p>Human Body Mode                      100pF ± 10%/1500 Ω ± 1%                      Air ± 8kV / contact ± 6kV                      Consecutive 10times/ Each discharge</p>  <table border="1" data-bbox="981 1131 1236 1243"> <thead> <tr> <th>CLASS</th> <th>STRESS LEVELS</th> </tr> </thead> <tbody> <tr> <td>CLASS I</td> <td>0-1000V</td> </tr> <tr> <td>CLASS II</td> <td>2000-3000V</td> </tr> <tr> <td>CLASS III</td> <td>4000-15000V</td> </tr> </tbody> </table>	CLASS	STRESS LEVELS	CLASS I	0-1000V	CLASS II	2000-3000V	CLASS III	4000-15000V	
CLASS	STRESS LEVELS										
CLASS I	0-1000V										
CLASS II	2000-3000V										
CLASS III	4000-15000V										
8	Vibration test(with carton)	<p>Total fixed                      amplitude:15mm                      Vibration Frequency :10~55Hz                      One cycle 60 seconds to 3 directions of                      X,Y,Z for Each 15 minutes</p>									
9	Drop (with carton)	<p>Height: 60cm                      1 corner, 3 edges, 6 surfaces</p>									

**Note: There is no display function NG issue occurred, all the cosmetic specification is judged before the reliability stress.**

## 8.0 Precautions





### 8.1 Operation

Burn-in sometimes happens when the same character was displayed at along time. Therefore, to prevent Burn-in, it is recommended to set up a Screen-saver function.

### 8.2 Safety

The liquid crystal in the LCD is poisonous, DO NOT put it in your mouth. If the liquid crystal touches your skin or clothes, wash it off immediately using soap and water.

### 8.3 Handling

	<p>a. The LCD module shall be installed flat, without twisting or bending.</p> <p>b. COF or FPC has narrow pattern width, so easily become open circuit by external force. DO NOT apply pressure to COF or FPC especially in bending area.</p>
	<p>c. To avoid damage in appearance or malfunction, DO NOT subject the module to mechanical shock or to excessive force on its surface.</p>
	<p>d. The polarizer attached to the display is very easy to damage, handle it with care to avoid scratching.</p>
	<p>e. To avoid contamination on the display surface, DO NOT touch the display surface with bare hands.</p> <p>f. Provide a space so that the LCD module does not come into contact with other components.</p>

## 8.4 Static Electricity

Since a module is composed of electronic circuits, it is not strong to electrostatic discharge.



- a. The LCD module shall be installed flat, without twisting or bending. Ground soldering iron tips, tools and testers when they operate.
- b. Ground your body when handling the products.
- c. DO NOT apply voltage to the input terminal without applying power supply.
- d. DO NOT apply voltage that exceeds the absolute maximum rating.
- e. Store the products in an anti-electrostatic container.
- f. Peel off protect tape, attached to polarizer, slowly to minimize ESD damage.

## 8.5 Storage



Store the products in a dark place at +5 ~ +25 degree C, low humidity (50%RH or less).  
DO NOT store the products in an atmosphere containing organic solvents or corrosive gases.

## 8.6 Cleaning



- a. DO NOT wipe the polarizer with dry cloth, as it might cause scratch.
- b. Wipe the polarizer with a soft cloth soaked with petroleum IPA, other chemical might damage.

## 8.7 Waste



When dispose of LCD module, manage it at the production waste according to the relevant laws and regulations.

Rev No	Issued Date.	Page
A	2021.12.07	14/18

## 9.0 OUTINE DIMENSION

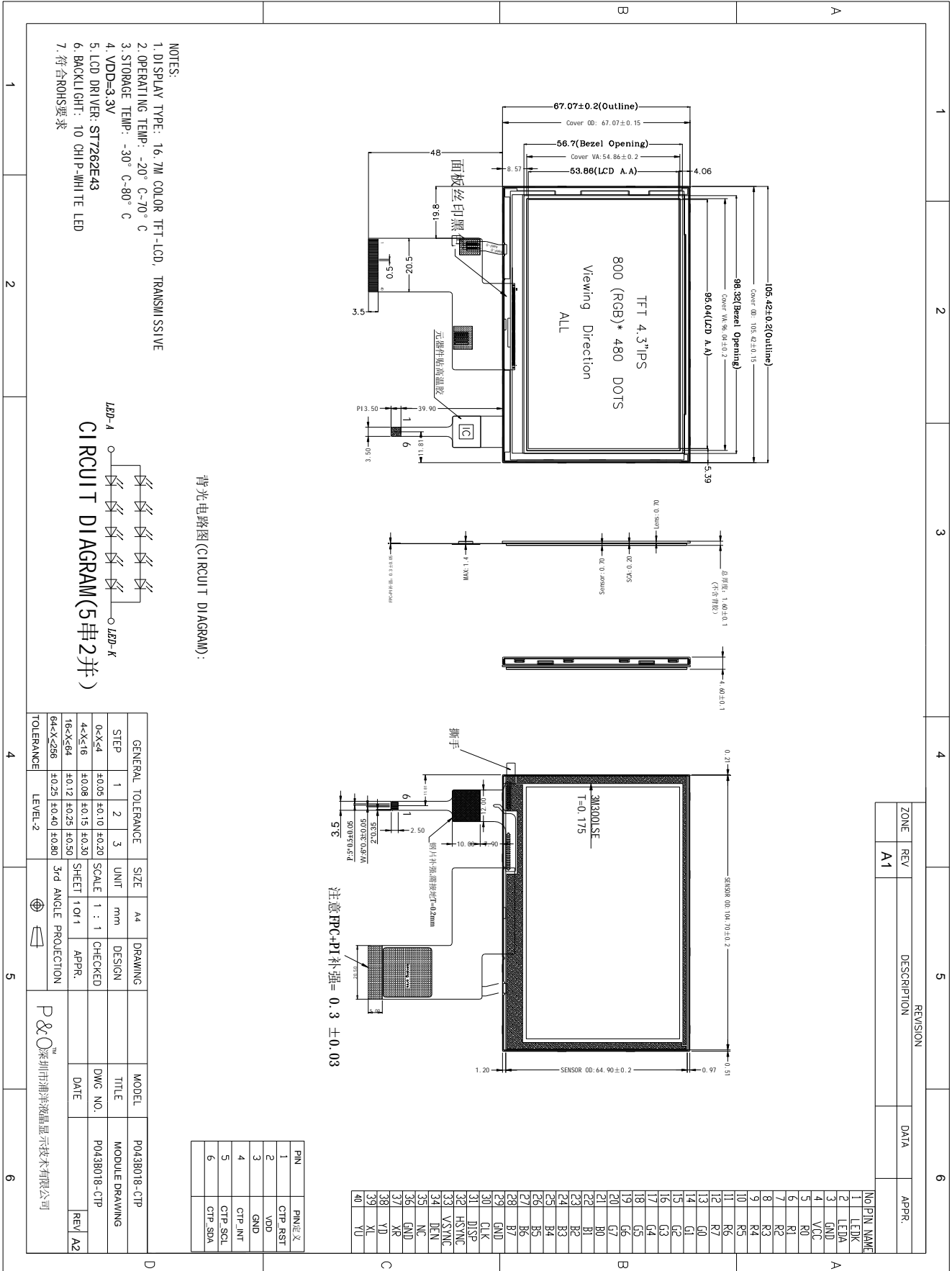

## 1 0.0 LOT MARK

### 10.1 Location of Lot Mark

- (1) Location: The label is attached to the backside of the LCD module.
- (2) Detail of the Mark: as attached below.
- (3) This is subject to change without prior notice.

## 11.0 PACKAGE SPECIFICATION

### 11.1 Packing form

LCM Model	LCM Qty. in the box	Inner Box Size ( mm )	Notice
	TDB	TDB	

### 11.2 Packing assembly drawings

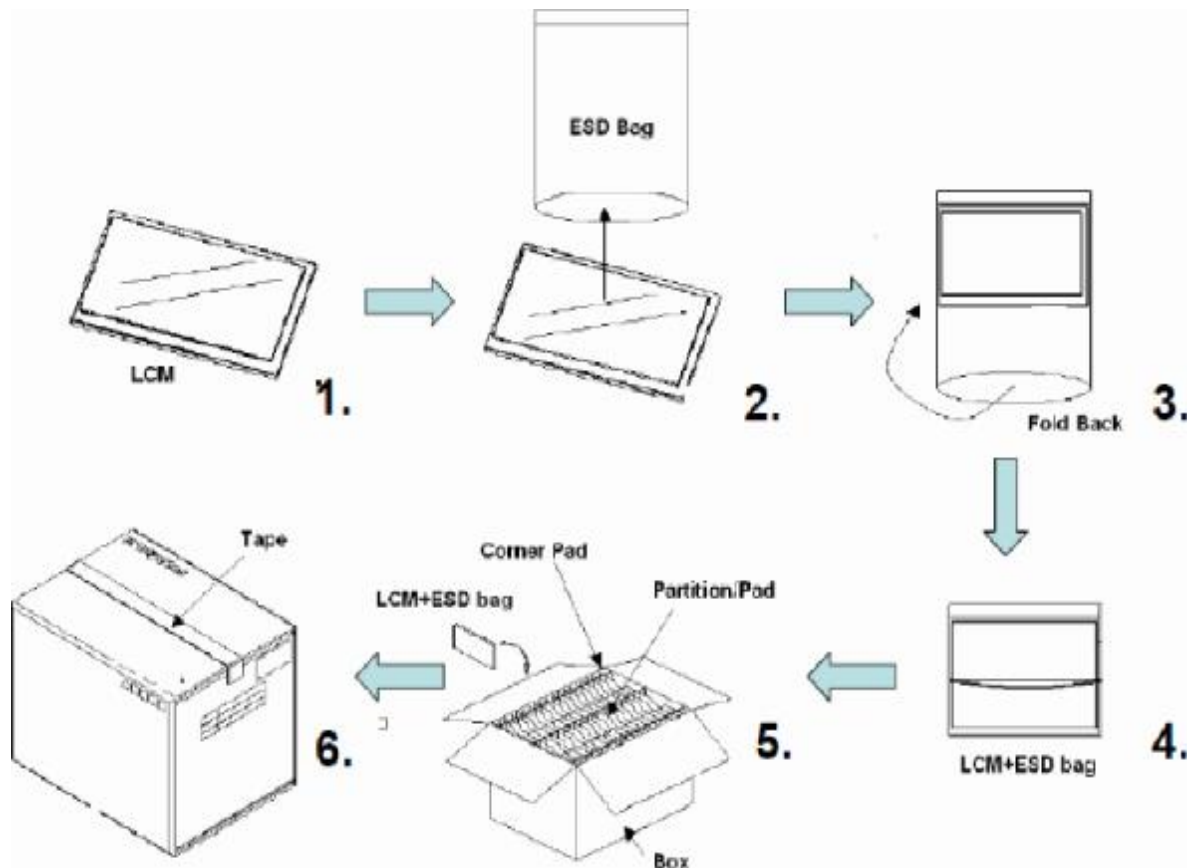

Items	Material	Notice
Box	Corrugated Paper Board	AB Flute
Partition/Pad	Corrugated Paper Board	A/B Flute
Corner Pad	Corrugated Paper Board	AB Flute
ESD bag	PE	

## 12.0 Items and Criteria:

### 12.1 Guarantee

APEX warrants the quality of our products for **1 year** (from the date of delivery). If there are functional defects found during the period of warranty, the defective products would be replaced on a one-to-one basis. Apex would not be responsible for any direct /indirect liabilities consequential to any parties.

All the products should be stored or used as specified conditions described in these sheets. If module productions are not stored or used as specified conditions, herein, it will be void the **1 year** warranty(guarantee).

### 12.2 Visual inspection criterion in cosmetic

#### (1) Glass defect

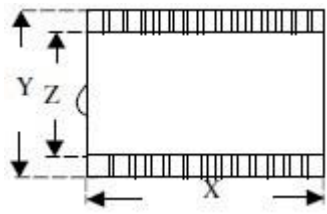
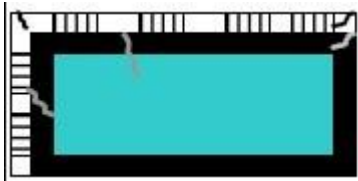
Glass defect			
NO	Defect	Criteria	Remark
1	Dimension(Minor)	By engineering diagram	
2	Cracks(Major)	Extensive crack <b>【Reject】</b>	

#### (2) LCM appearance defect

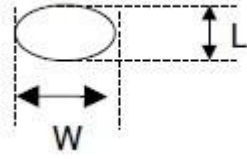
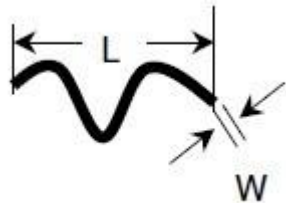
NO	Defect	Criteria		Remark
1	Round type(Minor)	Spec	Permissible Qty	1. $\psi = (L+W)/2$ , L: Length, W: Width 2. Disregard if out of A.A. 
		$\psi \leq 0.10\text{mm}$	Disregard	
		$0.10\text{mm} < \psi \leq 0.20\text{mm}$	3	
		$0.20\text{mm} < \psi$	0	
2	Line type(Minor)	Spec	Permissible Qty	1. L: Length, W: Width 2. Disregard if out of A.A. 
		$W \leq 0.03\text{mm}$	Disregard	
		$L \leq 3.0\text{mm}$ and $0.03\text{mm} < W \leq 0.05\text{mm}$	2	
		$L \leq 3.0\text{mm}$ and $0.05\text{mm} < W \leq 0.10\text{mm}$	1	
		$W > 0.10\text{mm}$ or $L > 3.0\text{mm}$	0	
3	Polarizer defect(Minor)	Spec.	Permissible Qty	1. $\psi = (L+W)/2$ , L: Length, W: Width 2. Disregard if out of A.A.
		$\psi \leq 0.20\text{mm}$	Disregard	
		$0.20\text{mm} < \psi \leq 0.30\text{mm}$	2	
		$0.30\text{mm} < \psi \leq 0.50\text{mm}$	1	



### (3) FPC

NO	Defect	Criteria	Remark
1	Copper peeling(Minor)	Copper peeling <b>【Reject】</b>	
2	Golden finger	FPC golden finger broken, dead fold, indentation makes FPC surface broken <b>【Reject】</b> Tin plating layer(or gold plating) scratch, but not hurt circuit <b>【Accept】</b> Except circuit, other position scratch but not expose metal wire <b>【Accept】</b>	
3	Pin	FPC PI layer delamination <b>【Reject】</b> Material and color are inconsistent with sample, FPC burrs <b>【Reject】</b> FPC Pin deformation but not affect function. <b>【Accept】</b> FPC Pin area is dirty <b>【Reject】</b> Other than FPC Pin area is dirty but not affect function <b>【Accept】</b>	
4	Golden finger	Golden finger edge has burrs,foreign material <b>【Reject】</b> Golden finger oxidation (dark), uneven electroplating, pinhole, foreign material <b>【Reject】</b> Golden finger soldering pad crack exceeds 1/3 length of soldering pad, and soldering pad crack exceed 2 Pins <b>【Reject】</b> Golden finger tin plating(or gold plating)scratch, but not hurt circuit <b>【Accept】</b> Other than golden finger area scratch but not expose metal circuit <b>【Accept】</b>	
5	FPC Silk printing	Ghosting, incomplete silk printing, wrong printing <b>【Reject】</b>	
6	FPC Circuit line width	Line width deviation exceed 1/3 line width <b>【Reject】</b>	

### (4) Black tape

NO	Defect	Criteria	Remark
1	Shift(Minor)	IC exposed <b>【Reject】</b>	
2	No black tape(Minor)	No black tape <b>【Reject】</b>	

### (5) Silicon

NO	Defect	Criteria	Remark
1	Amount of silicon (Minor)	ITO exposed <b>【Reject】</b>	

### 12.3 Visual inspection criterion in electrical display

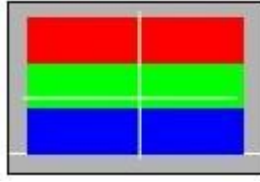
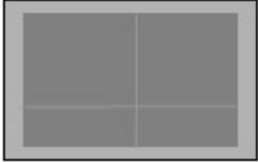
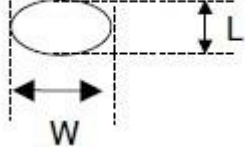
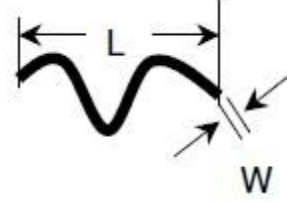
NO	Defect	Criteria		Remark
1	No display (Major)	Not allowed		
2	Missing line (Major)	Not allowed		
3	Darker or lighter Line (Major)	Not allowed		
4	Weak line(Major)	By limited sample		
5	Bright / Dark point (Minor)	Spec.	Permissible Qty	1:1sub-pixel: 1R or 1G or1B 2:Point defect area $\geq$ 1/2 sub pixel.
		Bright point	1	
		Dark point	2	
6	Round type (Minor)	Spec	Permissible Qty	1. $\psi=(L+W)/2$ , L: Length, W: Width 2. Disregard if out of A.A. 
		$\psi \leq 0.10\text{mm}$	Disregard	
		$0.10\text{mm} < \psi \leq 0.20\text{mm}$	3	
		$0.20\text{mm} < \psi$	0	
7	Line type (Minor)	Spec.	Permissible Qty	1. L: Length, W: Width 2. Disregard if out of A.A. 
		$W \leq 0.03\text{mm}$	Disregard	
		$L \leq 3.0\text{mm}$ and $0.03\text{mm} < W \leq 0.05\text{mm}$	2	
		$L \leq 3.0\text{mm}$ and $0.05\text{mm} < W \leq 0.10\text{mm}$	1	
		$W > 0.10\text{mm}$ or $L > 3.0\text{mm}$	0	
8	Mura (Minor)	By 5% ND filter invisible		

### 9.2.4. Others

- Issues that are not defined in this document shall be discussed and agreed with both parties.  
(Customer and supplier)
- Unless otherwise agreed upon in writing, the criteria shall be applied to both parties.  
(Customer and supplier)