

Shenzhen P&O Technology Co.,Limited	Rev No	Issued Date.	Page
	A	2022.3.3	1/16

Project Size.	7.0 inch	
Model No.	P070C012-CTP	
Samples No.		
Product type.	800xRGBx480 RGB mode	
Signature by customer:		
Prepared	Checked	Approved

Shenzhen P&O Technology Co.,Limited

Email: polcd@polcd.com

Mobile: 86-136 0019 7172

1.0 GENERAL DESCRIPTION

1.1 Introduction

Display model P070C012-CTP is a (TM)Transmissive type color active matrix thin Film transistor(TFT) liquid crystal display (LCD) that uses amorphous silicon TFT as a switching device.This model is composed of a TFT LCD panel, a driving circuit, a back light system. The resolution of a 7.0" contains 800_{RGB}x480 dots and can display up to 262k colors.

Item	Specification	Unit
Screen Size	7.0` inch	Diagonal
Number of Pixel	800RGB(H)x480(V)	Pixels
Display area	153.84(H)x85.63(V)	mm
Pixel pitch	0.0641(H)x0.1784(V)	mm
Outline Dimension	165.20x100.00x7.19	mm
Pixel arrangement	RGB Vertical Stripe	--
Display mode	Normally White	--
Viewing Direction(eye)	6 o'clock	--
Gray inversion direction	--	
Display Color	262k	--
Luminance(cd/m ²)	300	nit
Contrast Ratio	500:1	--
Surface treatment	--	--
Interface	RGB 24bit	
Back-light	LED Side-light type	--
Drive IC	1*EK9716BD4 + 1*EK73002AB2	
Operation Temperature	-20~70	°C
Storage Temperature	-30~80	°C
Weight	--	g

1.2 Features

- n RGB 24bit parallel interface.

1.3 Applications

- n MPOS Device.
- n Personal Navigation Device.
- n Other devices which require high quality displays.

2.0 INPUT INTERFACE PIN ASSIGNMENT

LCM FPC connector is used for electronics interface.

PinNo.	Symbol	Function
1-2	LEDA	LED back light(Anode)
3-4	LEDK	LED back light(Cathode)
5	GND	Ground
6	VCOM	Common Voltage (NC)
7	DVDD	Digital power supply
8	MODE	DE/SYNC mode select. Normally pull high. (H: DE mode. L: HS/VS mode)
9	DEN	Data enable signal
10	VSYNC	Vertical synchronization signal
11	HSYNC	Horizontal synchronization signal
12-19	B7-B0	Blue Data bus
20-27	G7-G0	Green Data bus
28-35	R7-R0	Red Data bus
36	GND	Ground
37	DOTCLK	Dot clock signal
38	GND	Ground
39	SHLR	Left/Right Display Control pin. Normal pull high
40	UPDN	Up/Down Display Control pin. Normal pull low
41	VGH	Positive Power for TFT
42	VGL	Negative Power for TFT
43	AVDD	Analog supply voltage
44	NRESET	Reset signal
45	NC	NC
46	VCOM	Common Voltage (NC)
47	DITHER	Dithering function control pin. Normal pull low. H: Enable dithering function, 6bit resolution. L: Disable dithering function, 8bit resolution
48	GND	Ground
49-50	NC	NC

CTP FPC connector is used for electronics interface.

1	CTP_SDA	Touch screen data signal
2	CTP_SCL	Touch screen clock signal
3	CTP_RST	Touch screen reset
4	CTP_INT	Touch screen interrupt signal
5	GND	Ground
6	VCC_3.3V	Power Supply

3.0 ABSOLUTE MAXIMUM RATINGS

3.1 Electrical Absolute Rating

3.1.1 TFT LCD Module

Item	Symbol	Min	Max	Unit	Note
Digital supply voltage	VDDI	-0.3	+4.6	V	GND=0
Analog supply voltage	VCI	-0.3	+4.6	V	GND=0
Logic Signal Input Level	VIN	-0.3	VDDI+0.5	V	GND=0

3.1.2 Back-Light Unit

Item	Symbol	Min	Max	Unit	Note
LED current	I _{BL}	90	120	mA	-
LED voltage	V _{BL}	8.4	9.6	V	-

3.2 Environment Absolute Rating

Item	Symbol	Min	Max	Unit	Note
Operating temperature	TOPR	-20	70	°C	-
Storage temperature	TSTG	-30	80	°C	-

Note:

Permanent damage may occur to the LCD module if beyond this specification.

Shenzhen P&O Technology Co., Limited	Rev No	Issued Date.	Page
	A	2022.3.3	5/16

4.0 OPTICAL CHARACTERISTICS

4.1 Optical specification

Item		Symbol	Condition	Min	Type	Max	Unit	Note
White luminance (Center)		Lv	$\Theta=0$ Normal Viewing Angle $I_{BL}=120mA$	--	300	--	cd/m ²	
Response time		Tr+Tf		--	5	15	ms	
Contrast ratio		CR		--	500	--	--	
Color Chromaticity (CIE1931)	white	Wx		0.276	0.306	0.336		
		Wy	0.314	0.344	0.374			
Viewing Angle	Hor	Θ_L	CR \geq 10	60	70	--		
		Θ_R		60	70	--		
	Ver	Θ_U		50	60	--		
		Θ_D		60	70	--		
Brightness uniformity		Avg	$\Theta=0$	80	90	--	%	
Color Gamut		NTSC	$\Theta=0$	--	50	--	%	
Optima View Direction		6 o'clock						

4.2 Measuring Condition

- n Measuring surrounding: dark room
- n LED current IL:120mA
- n Ambient temperature: 25±2℃
- n 15min. warm-up time

4.3 Measuring Equipment

- n FPM520 of Westar Display technologies, INC., which utilized SR-3 for Chromaticity and BM-7 for other optical characteristics.
- n Measuring spot size: 20 ~ 21 mm

Note (1) Definition of Viewing Angle

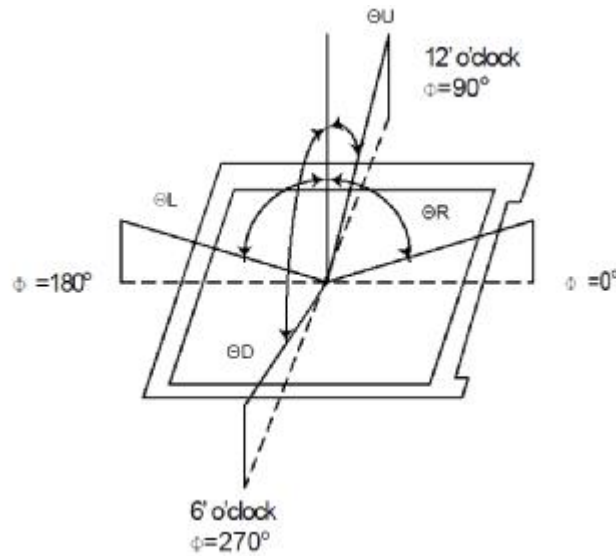

Note (2) Definition of Contrast Ratio(CR):

Measured at the center point of panel

$$CR = \frac{\text{Luminance with all pixels white}}{\text{Luminance with all pixels black}}$$

Note (3) Definition of Response Time: Sum of TR and TF

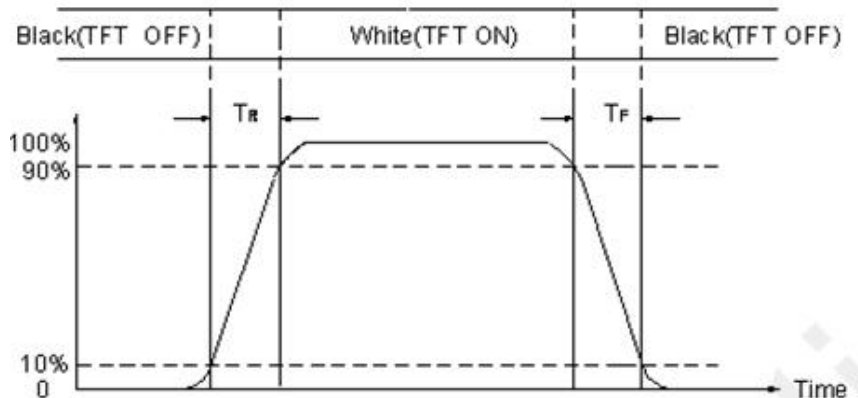

Note (4) Definition of optical measurement setup

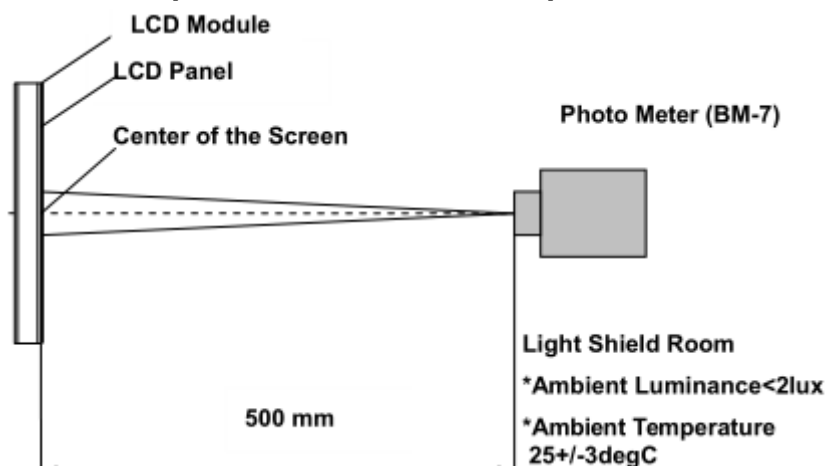

Note (5) Definition of brightness uniformity

The luminance uniformity is calculated by using following formula.

$$\Delta B_p = B_p (\text{Min.}) / B_p (\text{Max.}) \times 100 (\%)$$

$B_p (\text{Max.})$ = Maximum brightness in 9 measured spots

$B_p (\text{Min.})$ = Minimum brightness in 9 measured spots .

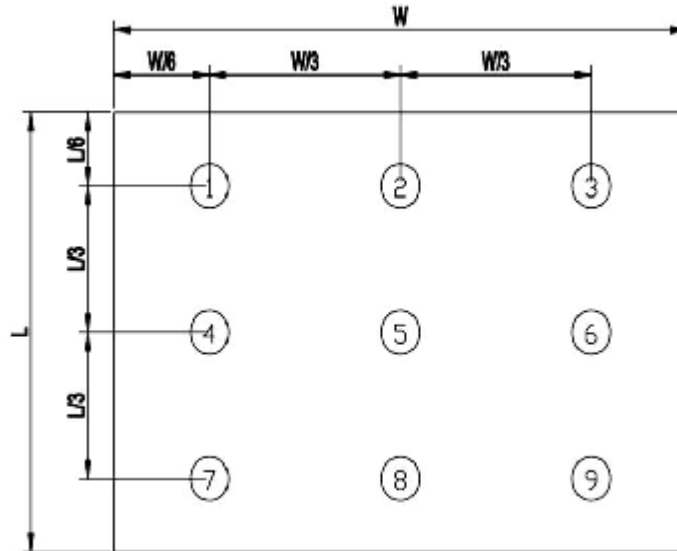

Note (6) Definition of Color of CIE1931 Coordinate and NTSC Ratio.

Color gamut:

$$S = \frac{\text{Area of RGB triangle}}{\text{Area of NTSC triangle}} \times 100\%$$

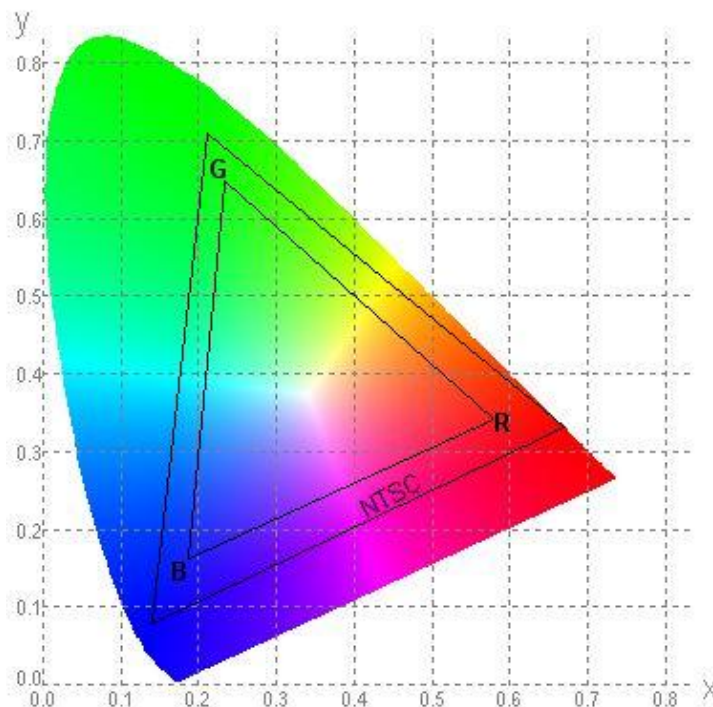

Note (7) Measured the luminance of white state at center point.

5.0 BLOCK DIAGRAM

5.1 TFT LCD Module

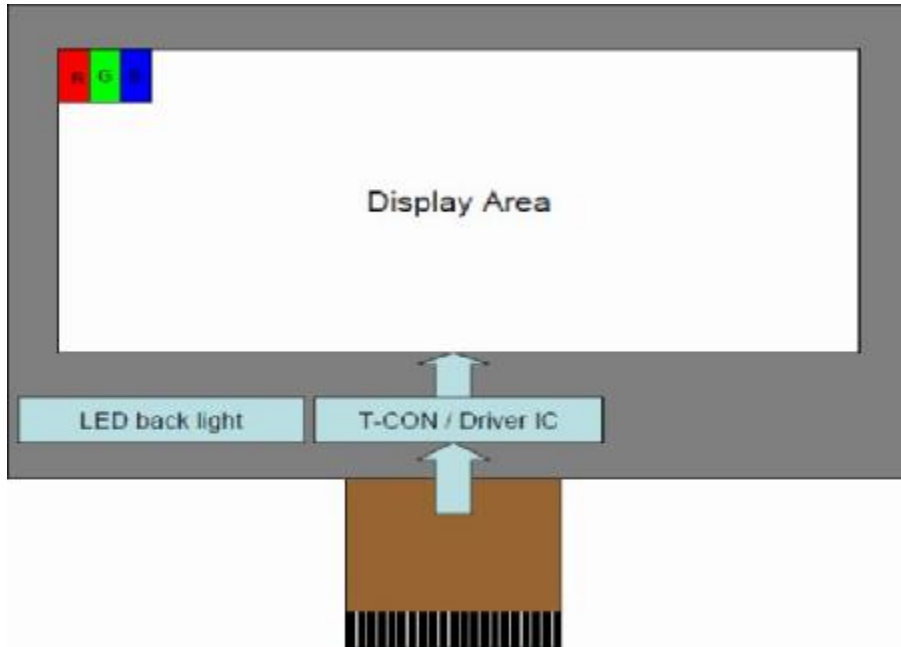

5.2 Pixel Format

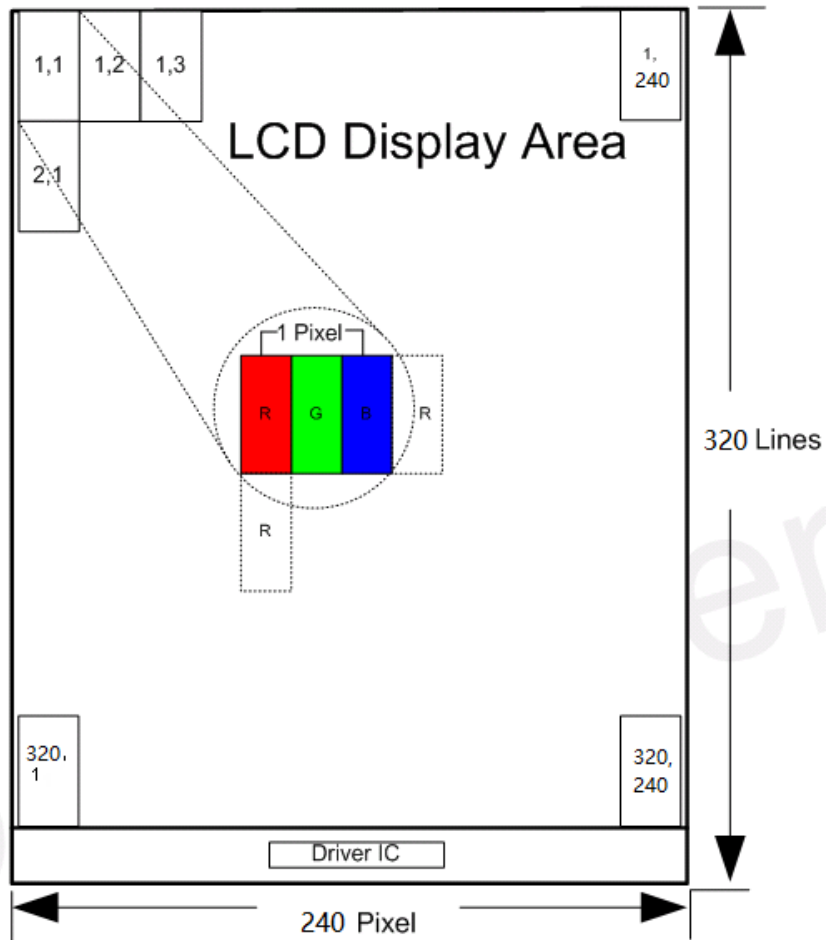

6.0 ELECTRICAL CHARACTERISTICS

6.1 TFT LCD Module

Item	Symbol	Min.	Typ.	Max.	Unit	Remark
Analog supply voltage	VDD	2.4	2.8	3.3	V	
Digital supply voltage	VDDI	1.65	1.8	3.3		
Input signal Voltage	VIH	0.7VDDI	-	VDDI	V	
	VIL	GND	-	0.3VDDI	V	

6.2 Back-Light Unit

The backlight system is an edge-lighting type with 18 LED Dies.

The characteristics of the LED are shown in the following tables.

Item	Symbol	Min	Typ	Max	Unit	Note
LED current	IL	-	90	120	mA	(2)
LED voltage	VL	-	8.4	9.6	V	
Operating LED life time	Hr	-	5000	5500	Hour	(1)(2)

Note (1) LED life time (Hr) can be defined as the time in which it continues to operate under the condition: $T_a=25\pm 3\text{ }^\circ\text{C}$, typical IL value indicated in the above table until the brightness becomes less than 50%.

Note (2) The “LED life time” is defined as the module brightness decrease to 50% original brightness at $T_a=25^\circ\text{C}$ and $I_L=80\text{mA}$. The LED lifetime could be decreased if operating I_L is larger than 100mA. The constant current driving method is suggested.

Note (3) Suggested schematic of LED backlight driver

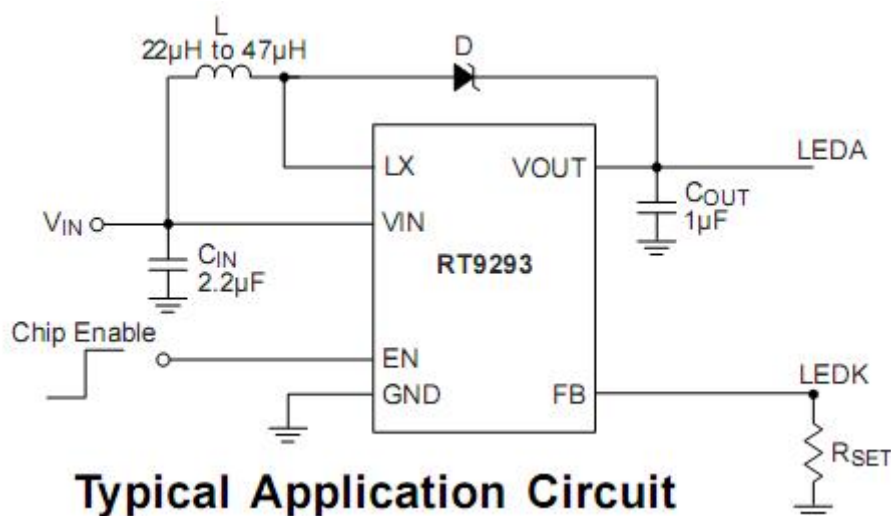

6.3 Interface Characteristics

8080 Series RGB Parallel Interface Characteristics: 24-bit Bus

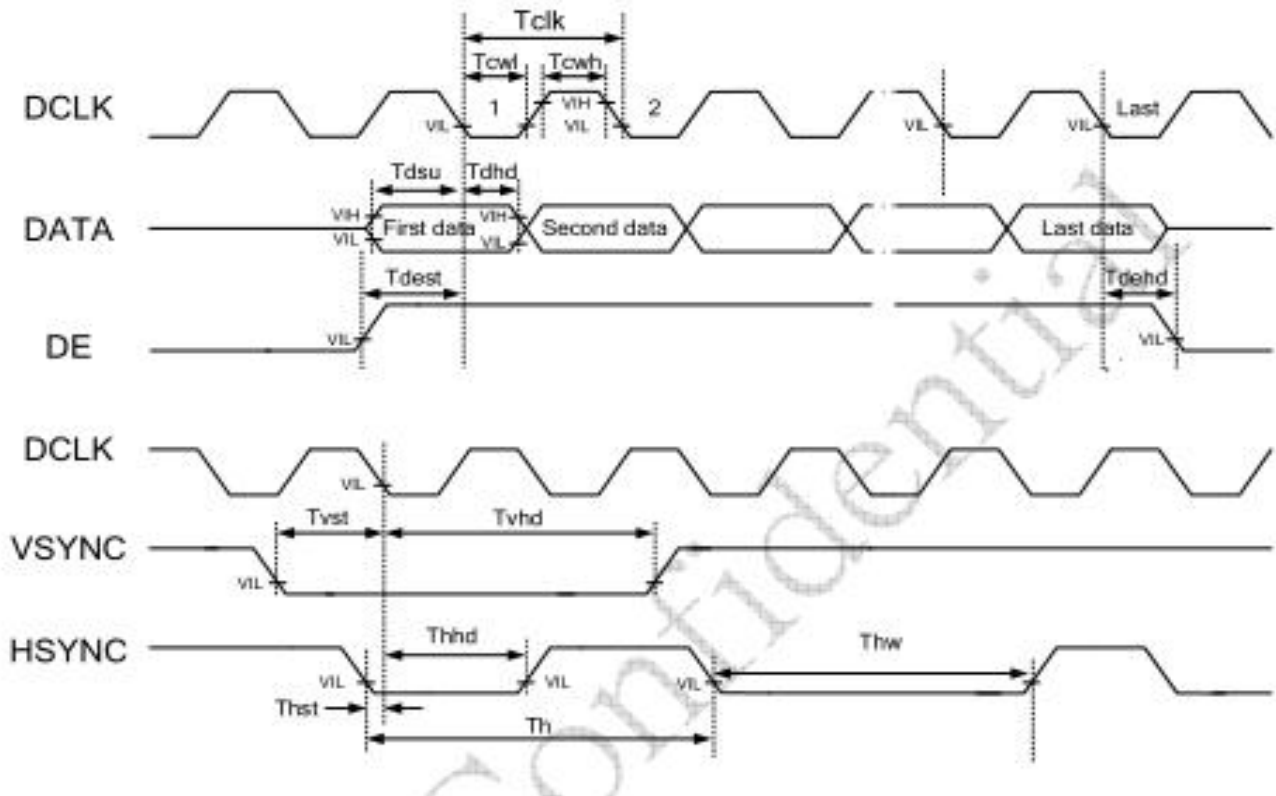

10.1.1 Parallel 24-bit RGB Timing Table

Item	Symbol	Min.	Typ.	Max.	Unit	Remark	
DCLK Frequency	Fclk	8	9	12	MHz		
DCLK Period	Tclk	83	111	125	ns		
HSYNC	Period Time	Th	485	531	598	DCLK	
	Display Period	Thdisp	-	480	-	DCLK	
	Back Porch	Thbp	3	43	43	DCLK	By H_Blanking setting
	Front Porch	Thfp	2	8	75	DCLK	
	Pulse Width	Thw	2	4	75	DCLK	
VSYNC	Period Time	Tv	276	292	321	H	
	Display Period	Tvdisp	-	272	-	H	
	Back Porch	Tvbp	2	12	12	H	By V_Blanking setting
	Front Porch	Tvfp	2	8	37	H	
	Pulse Width	Tvw	2	4	37	H	

Note: It is necessary to keep Tvbp =12 and Thbp =43 in sync mode. DE mode is unnecessary to keep it.

7.0 Reliability conditions

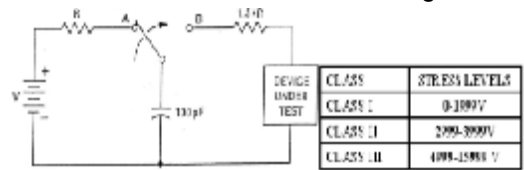
NO	Item	Conditions	Notes
1	High Temperature Storage	Ta=80°C ± 2°C, 72hrs	
2	Low Temperature Storage	Ta=-30°C ± 2°C, 72hrs	
3	High Temperature Operation	Ta=70°C ± 2°C, 72hrs(Operation state)	
4	Low Temperature Operation	Ta=-20°C ± 2°C, 72hrs(Operation state)	
5	High Temperature and High Humidity (Storage)	Ta=+60°C, 90%RH, 72hrs	
6	Thermal Cycling Test (non operation)	-20°C (30min) → +70°C (30min), 10cycles	
7	Electro static Discharge	Human Body Mode 100pF ± 10%/1500 Ω ± 1% Air ± 8kV / contact ± 6kV Consecutive 10times/ Each discharge 	
8	Vibration test(with carton)	Total fixed amplitude:15mm Vibration Frequency :10~55Hz One cycle 60 seconds to 3 directions of X,Y,Z for Each 15 minutes	
9	Drop (with carton)	Height: 60cm 1 corner, 3 edges, 6 surfaces	

Note: There is no display function NG issue occurred, all the cosmetic specification is judged before the reliability stress.

Rev No	Issued Date.	Page
A	2022.3.3	12/16

8.0 OUTINE DIMENSION

* Unspecified Tolerances is: ± 0.2

LCD TYPE	7 inch TFT Transmissive
DISPLAY MODE	Normally white
VIEW DIRECTION	6 o'clock
OPERATING TEMP.	-10° C ~ 50° C
STORAGE TEMP.	-20° C ~ 60° C
BACK LIGHT	27 white leds
BL voltage/current	9.6V / 180mA

ALL MATERIALS MUST BE ROHS COMPLIANT

BACKLIGHT CIRCUIT

NO.	Pin name	NO.	Pin name
1	A1	33	R2
2	A2	34	R1
3	K1	35	R0
4	K2	36	GND
5	GND	37	DLCLK
6	VCOM	38	GND
7	DVID	39	LR
8	MODE	40	UD
9	DE	41	VGH
10	VS	42	VGL
11	HS	43	AVDD
12	B7	44	RESET
13	B6	45	NC
14	B5	46	VCOM
15	B4	47	DITHB
16	B3	48	GND
17	B2	49	NC
18	B1	50	NC
19	B0		
20	G7		
21	G6		
22	G5		
23	G4		
24	G3		
25	G2		
26	G1		
27	G0		
28	R7		
29	R6		
30	R5		
31	R4		
32	R3		

CTP IC: GT911

Pin	NAME
1	S0A
2	S0L
3	RST
4	INT
5	GND
6	VDD 3.3V

UNIT: mm	SCALE: NO SCALE	SIZE: A4
GENERAL TOLERANCE: ± 0.2 Angle=1°		
DESIGNED: czs	Date: 2019-10-11	PART NAME: MODULE DRAWING
CHECKED:	Date:	PROJECT NO: P070C012-CTP
APPROVED:	Date:	PART NO:
		SHEET: 1/1
		REV: A

9.0 LOT MARK

9.1 Location of Lot Mark

- (1) Location: The label is attached to the backside of the LCD module.
- (2) Detail of the Mark: as attached below.
- (3) This is subject to change without prior notice.

10.0 PACKAGE SPECIFICATION

10.1 Packing form

LCM Model	LCM Qty. in the box	Inner Box Size (mm)	Notice
	TDB	TDB	

10.2 Packing assembly drawings

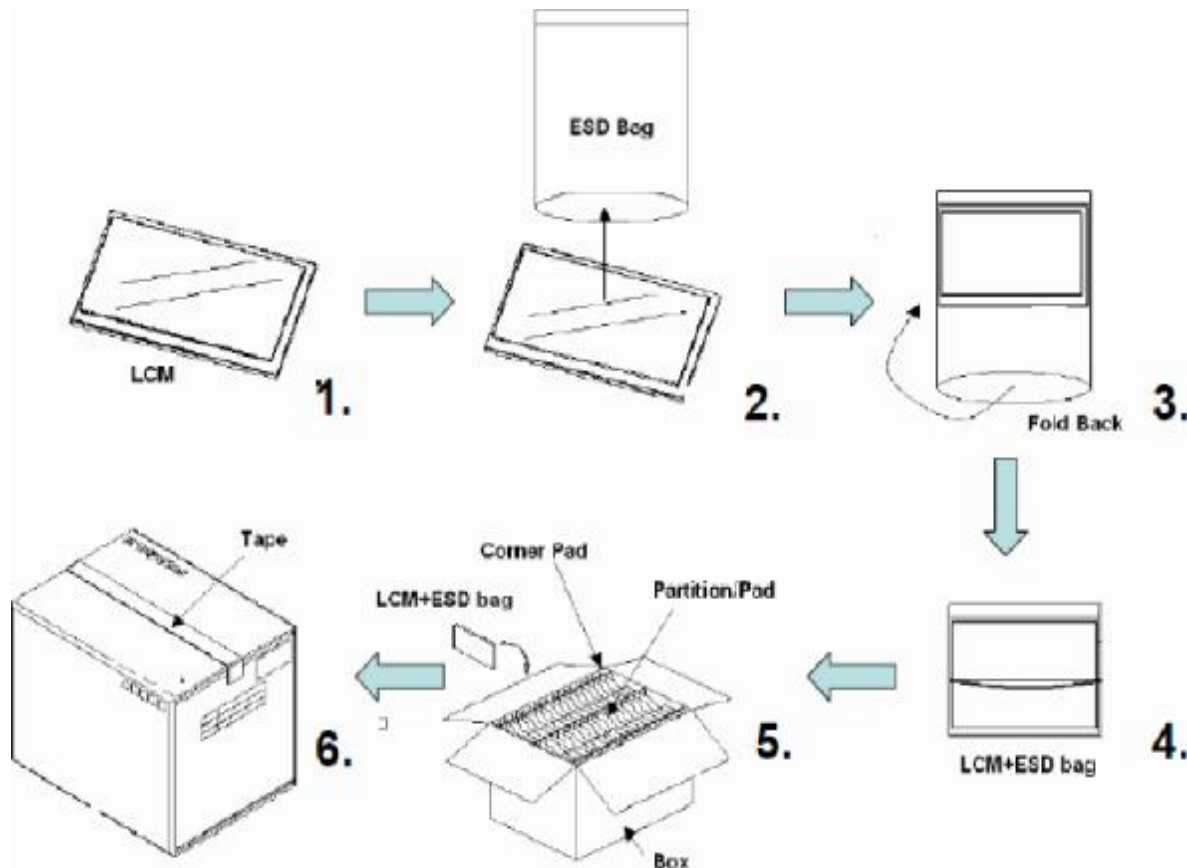

Items	Material	Notice
Box	Corrugated Paper Board	AB Flute
Partition/Pad	Corrugated Paper Board	A/B Flute
Corner Pad	Corrugated Paper Board	AB Flute
ESD bag	PE	

11.0 Items and Criteria:

11.1 Guarantee

APEX warrants the quality of our products for **1 year** (from the date of delivery). If there are functional defects found during the period of warranty, the defective products would be replaced on a one-to-one basis. Apex would not be responsible for any direct /indirect liabilities consequential to any parties.

All the products should be stored or used as specified conditions described in these sheets. If module productions are not stored or used as specified conditions, herein, it will be void the **1 year** warranty(guarantee).

11.2 Visual inspection criterion in cosmetic

(1) Glass defect

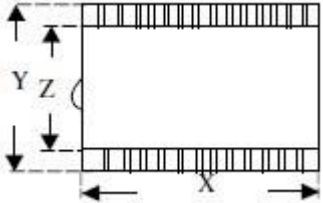
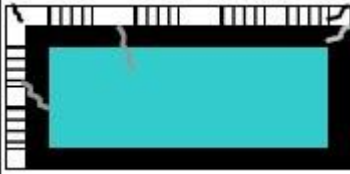
Glass defect			
NO	Defect	Criteria	Remark
1	Dimension(Minor)	By engineering diagram	
2	Cracks(Major)	Extensive crack 【Reject】	

(2) LCM appearance defect

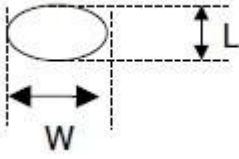
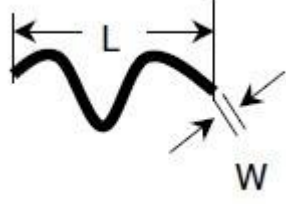
NO	Defect	Criteria		Remark
1	Round type(Minor)	Spec	Permissible Qty	1. $\psi = (L+W)/2$, L: Length, W: Width 2. Disregard if out of A.A. 
		$\psi \leq 0.10\text{mm}$	Disregard	
		$0.10\text{mm} < \psi \leq 0.20\text{mm}$	3	
		$0.20\text{mm} < \psi$	0	
2	Line type(Minor)	Spec	Permissible Qty	1. L: Length, W: Width 2. Disregard if out of A.A. 
		$W \leq 0.03\text{mm}$	Disregard	
		$L \leq 3.0\text{mm}$ and $0.03\text{mm} < W \leq 0.05\text{mm}$	2	
		$L \leq 3.0\text{mm}$ and $0.05\text{mm} < W \leq 0.10\text{mm}$	1	
		$W > 0.10\text{mm}$ or $L > 3.0\text{mm}$	0	
3	Polarizer dent(Minor)	Spec.	Permissible Qty	1. $\psi = (L+W)/2$, L: Length, W: Width 2. Disregard if out of A.A.
		$\psi \leq 0.20\text{mm}$	Disregard	
		$0.20\text{mm} < \psi \leq 0.30\text{mm}$	2	
		$0.30\text{mm} < \psi \leq 0.50\text{mm}$	1	

(3) FPC

NO	Defect	Criteria	Remark
1	Copper peeling(Minor)	Copper peeling 【Reject】	
2	Golden finger	FPC golden finger broken, dead fold, indentation makes FPC surface broken 【Reject】 Tin plating layer(or gold plating) scratch, but not hurt circuit 【Accept】 Except circuit, other position scratch but not expose metal wire 【Accept】	
3	Pin	FPC PI layer delamination 【Reject】 Material and color are inconsistent with sample, FPC burrs 【Reject】 FPC Pin deformation but not affect function. 【Accept】 FPC Pin area is dirty 【Reject】 Other than FPC Pin area is dirty but not affect function 【Accept】	
4	Golden finger	Golden finger edge has burrs,foreign material 【Reject】 Golden finger oxidation (dark), uneven electroplating, pinhole, foreign material 【Reject】 Golden finger soldering pad crack exceeds 1/3 length of soldering pad, and soldering pad crack exceed 2 Pins 【Reject】 Golden finger tin plating(or gold plating)scratch, but not hurt circuit 【Accept】 Other than golden finger area scratch but not expose metal circuit 【Accept】	
5	FPC Silk printing	Ghosting, incomplete silk printing, wrong printing 【Reject】	
6	FPC Circuit line width	Line width deviation exceed 1/3 line width 【Reject】	



(4) Black tape

NO	Defect	Criteria	Remark
1	Shift(Minor)	IC exposed 【Reject】	
2	No black tape(Minor)	No black tape 【Reject】	

(5) Silicon

NO	Defect	Criteria	Remark
1	Amount of silicon (Minor)	ITO exposed 【Reject】	

11.3 Visual inspection criterion in electrical display

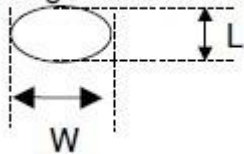
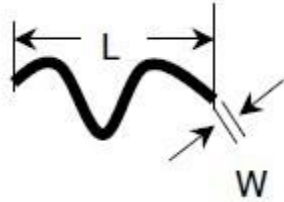
NO	Defect	Criteria		Remark
1	No display (Major)	Not allowed		
2	Missing line (Major)	Not allowed		
3	Darker or lighter Line (Major)	Not allowed		
4	Weak line(Major)	By limited sample		
5	Bright / Dark point (Minor)	Spec.	Permissible Qty	1:1sub-pixel: 1R or 1G or1B 2:Point defect area \geq 1/2 sub pixel.
		Bright point	1	
		Dark point	2	
6	Round type (Minor)	Spec	Permissible Qty	1. $\psi=(L+W)/2$, L: Length, W: Width 2. Disregard if out of A.A. 
		$\psi \leq 0.10\text{mm}$	Disregard	
		$0.10\text{mm} < \psi \leq 0.20\text{mm}$	3	
		$0.20\text{mm} < \psi$	0	
7	Line type (Minor)	Spec.	Permissible Qty	1. L: Length, W: Width 2. Disregard if out of A.A. 
		$W \leq 0.03\text{mm}$	Disregard	
		$L \leq 3.0\text{mm}$ and $0.03\text{mm} < W \leq 0.05\text{mm}$	2	
		$L \leq 3.0\text{mm}$ and $0.05\text{mm} < W \leq 0.10\text{mm}$	1	
		$W > 0.10\text{mm}$ or $L > 3.0\text{mm}$	0	
8	Mura (Minor)	By 5% ND filter invisible		

11.4 Others

- Issues that are not defined in this document shall be discussed and agreed with both parties.
(Customer and supplier)
- Unless otherwise agreed upon in writing, the criteria shall be applied to both parties.
(Customer and supplier)