

# RYZ012

## Wireless Communication Module for Bluetooth® 5 Low Energy

### Description

The RYZ012 is a highly integrated wireless communication module that provides a qualified solution for BLE 5 Bluetooth® 5 Low Energy (LE). The integrated processor runs the network stack. The network stacks are executed inside the module, so there is no need for external stack operation.

The integrated wireless solution combines the features and functions needed for 2.4-GHz IoT standards into a single module. End products built using this module comply with the Bluetooth standard, supports LE specification up to Bluetooth 5 and allows simple connectivity with Bluetooth LE mobile phones, tablets and laptops. The Bluetooth LE stack supports Bluetooth LE slave and master mode operation, including broadcast, encryption, connection updates, and channel map updates.

The RYZ012 integrates hardware acceleration to support the complicated security operations. The module is available in two configurations (A and B) with or without a mounted antenna. This allows for implementation flexibility and the option for longer wireless range requirements.

### Typical Applications

Typical applications of the RYZ012:

- Portable devices and equipment
- Smart lighting, smart home devices
- Remote equipment
- Building automation
- Smart grid
- Intelligent logistics, transportation, and tracking
- Industrial control
- Health care

### Features

**Table 1. Specifications of RYZ012**

Feature	Functional description
RF	<ul style="list-style-type: none"> <li>• Bluetooth LE RF transceiver embedded, working in worldwide 2.4-GHz ISM band</li> <li>• Bluetooth 5 compliant, 1-Mbps, 2-Mbps, Long Range 125 kbps and 500 kbps</li> <li>• Rx Sensitivity:                             <ul style="list-style-type: none"> <li>—96dBm at Bluetooth LE 1-Mbps mode</li> <li>—93dBm at Bluetooth LE 2-Mbps mode</li> <li>—99dBm at Bluetooth LE 500-kbps mode</li> <li>—101dBm at Bluetooth LE 125-kbps mode</li> </ul> </li> <li>• Tx output power: up to +10dBm</li> <li>• Single-pin antenna interface</li> <li>• RSSI monitoring with ±1dB resolution</li> <li>• Auto acknowledgment, retransmission and flow control</li> </ul>
Supported standard	<ul style="list-style-type: none"> <li>• Bluetooth 5 Low Energy</li> </ul>

## Pin Arrangement

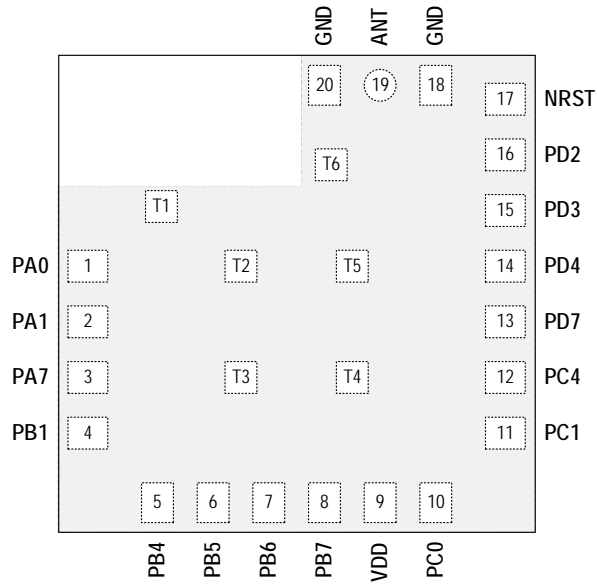

## Pin Description

Pin No.	Name	Type	Driving Strength		Notes	Input/Output in used	
			High	Low		PB5 = Low (UART)	PB5 = High (SPI)
1	PA0	Digital I/O	4 mA	2 mA	UART RX	Input (RX)	Open (Unused)
2	PA1	Digital I/O	4 mA	2 mA	Unused	Open (Unused)	
3	PA7	Digital I/O	8 mA	4 mA	SWS enabled after power on	Pull up (SWS)	
4	PB1	Digital I/O	8 mA	4 mA	UART TX	Output (TX)	Open (Unused)
5	PB4	Digital I/O	16 mA	12 mA	Interrupt	Output	
6	PB5	Digital I/O	16 mA	12 mA	UART/SPI Select (Set low for UART, set high for SPI)	Input (Low)	Input (High)
7	PB6	Digital I/O	16 mA	12 mA	SPI DI	Open (Unused)	Input (DI)
8	PB7	Digital I/O	16 mA	12 mA	SPI DO	Open (Unused)	Output (DO)
9	VDD	Supply	N/A		Power supply input	VDD	
10	PC0	Digital I/O	4 mA	2 mA	Unused	Open (Unused)	
11	PC1	Digital I/O	4 mA	2 mA	Unused	Open (Unused)	
12	PC4	Digital I/O	4 mA	2 mA	Unused	Open (Unused)	
13	PD7	Digital I/O	4 mA	2 mA	SPI Clock	Open (Unused)	Input (SPI Clock)
14	PD4	Digital I/O	4 mA	2 mA	Unused	Open (Unused)	
15	PD3	Digital I/O	4 mA	2 mA	Unused	Open (Unused)	
16	PD2	Digital I/O	4 mA	2 mA	SPI CN	Open (Unused)	Input (SPI CN)
17	NRST	Reset	N/A		Reset	Reset	
18	GND	Supply	N/A		Ground	GND	
19	ANT	Analog	N/A		No connection for RYZ012A	Open (RYZ012A)	
					50-Ω Antenna for RYZ012B	Antenna (RYZ012B)	
20	GND	Supply	N/A		Ground	GND	
T1 – T6	GND	Supply	N/A		Ground	GND	

## System Control

### Reset

The module supports different reset types, each with a different scope:

- Power-on-Reset - On power-on the whole chip is reset. Consequently, all registers are set to their default values.
- Software Reset – All serial interface software items to control the protocol stacks support a serial command to reset the module.

### Power Supply

The device must be powered with an operating voltage between 1.8 V and 3.6 V. Internal DC/DC and LDO converters generate the internal supply voltages required for operation. The chip's embedded DCDC generates 1.8-V output voltage as power supply for the internal flash and generates 1.4-V output voltage as input to the LDO.

The embedded LDO regulator takes the 1.4-V voltage output from the DCDC and generates 1.2-V regulated voltage to supply power for 1.2-V digital core and analog modules.

### Power-On-Reset (POR) and Brown-out Detect

The module's power supply status is controlled by the UVLO (Ultra-low Voltage Lockout), PL (Power Logic) module, and the external NRST pin through the logic shown in Figure 1. UVLO takes the external power supply as input and releases the lock only when the power supply voltage is higher than a predefined threshold. Typical values for these thresholds are shown in Table 2. The NRST pin has an internal pull-up resistor. An external capacitor can be connected on the NRST pin to control the POR delay.

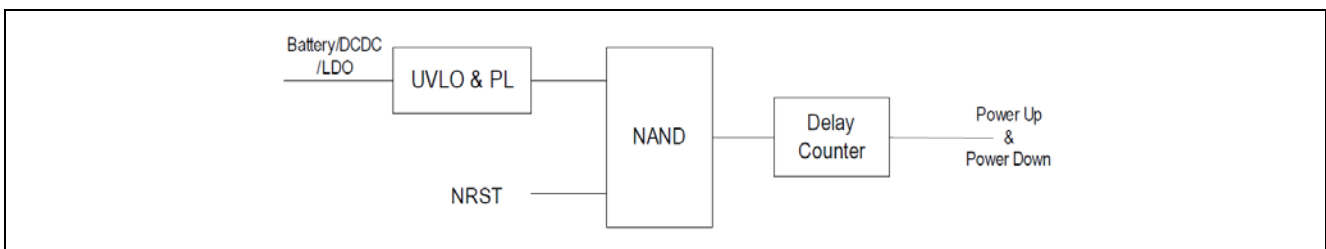

Figure 1. Power control logic

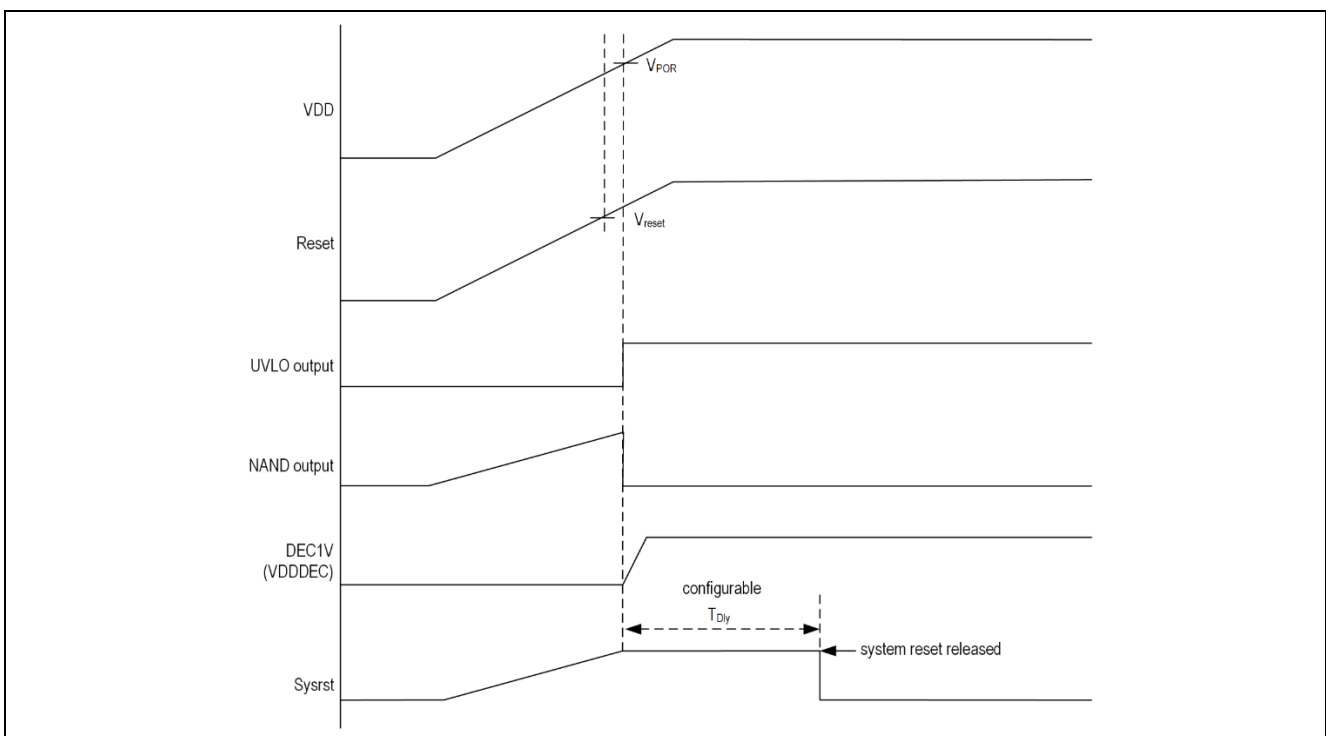

Figure 2. Power-up sequence

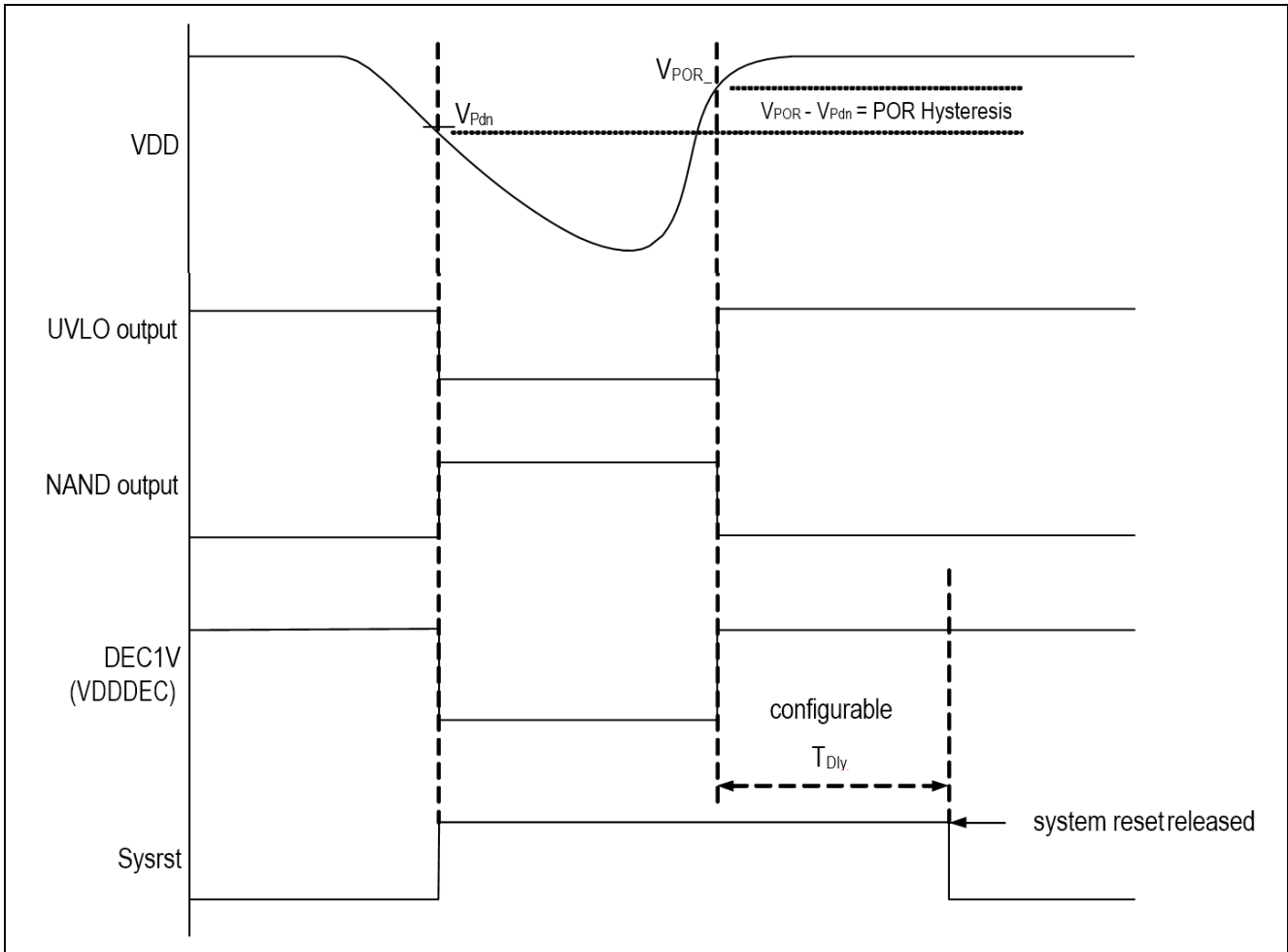

Figure 3. Power-down sequence

Table 2. Characteristics of the power control logic

Symbol	Parameter	Minimum	Typical	Maximum	Unit
V <sub>POr</sub>	VDD voltage when VUVLO turns to high level	-	1.62	-	V
V <sub>Pdn</sub>	VDD voltage when VUVLO turns to low level	-	1.55	-	V

### Single Wire Interface

The RYZ012 supports the Single Wire interface (SWIRE). SWM (Single Wire Master) and SWS (Single Wire Slave) represent the master and slave device of the single wire communication system. The maximum data rate can be up to 2 Mbps.

The Single Wire Interface is used for device programming.

### Bluetooth LE RF Transceiver

The RYZ012 integrates an advanced Bluetooth LE RF transceiver. The RF transceiver works in the worldwide 2.4-GHz ISM (Industrial Scientific Medical) band.

The transceiver consists of a fully integrated RF synthesizer, a Power Amplifier (PA), a Low Noise Amplifier (LNA), a TX filter, an RX filter, a TX DAC, an ADC, a modulator, and a demodulator. The transceiver can be configured to work in standard-compliant 1-Mbps Bluetooth LE mode, 2-Mbps enhancement Bluetooth LE mode, 125-kbps Bluetooth LE long-range mode (S8), and 500-kbps Bluetooth LE long-range mode (S2). The internal PA can deliver a maximum 10dBm output power, avoiding the need for an external RF PA.

Figure 4 shows a block diagram of the RF transceiver.

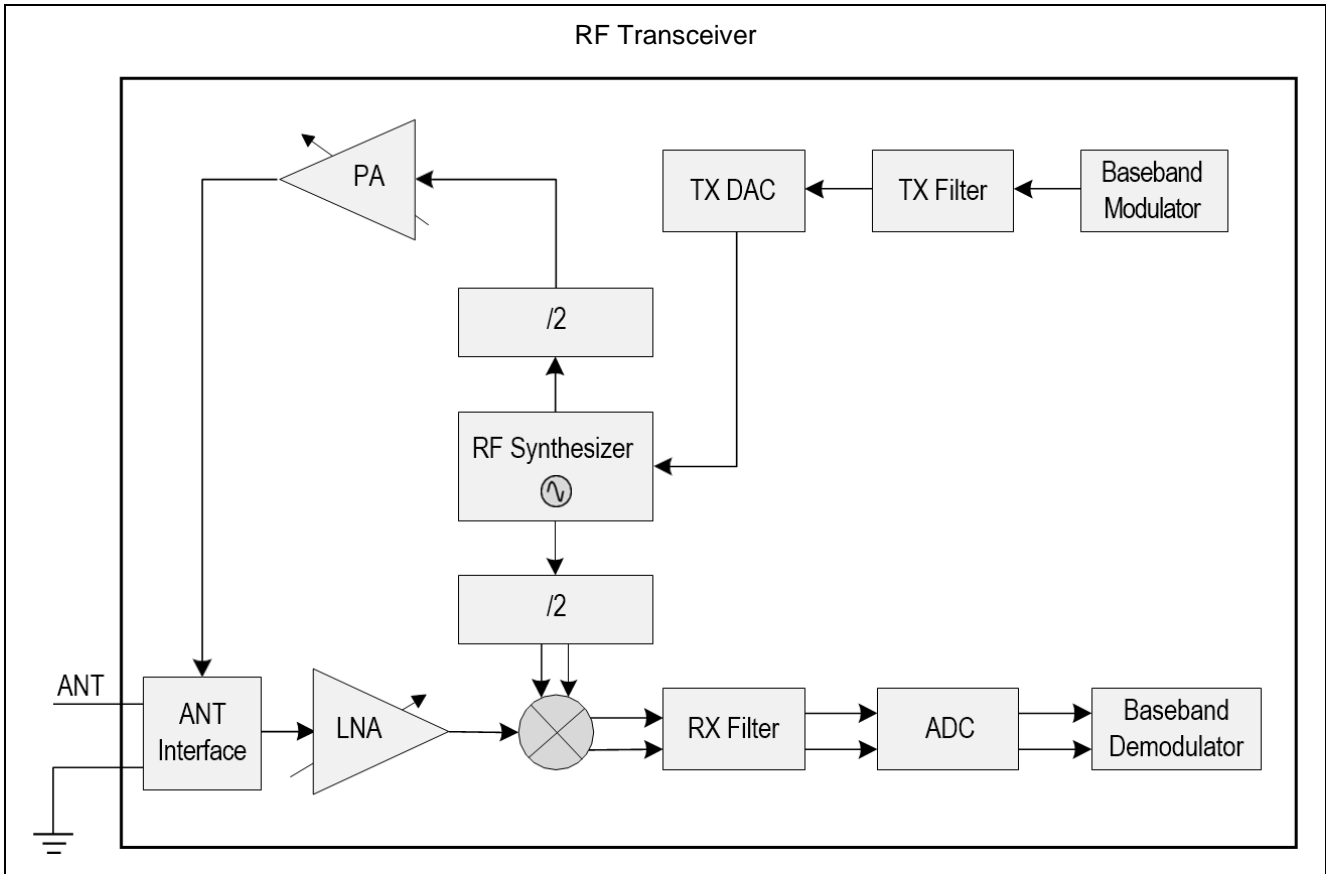

Figure 4. Block diagram of RF transceiver

### Baseband

The baseband contains dedicated hardware logic to perform fast AGC control, access code correlation, CRC checking, data whitening, encryption/decryption, and frequency hopping logic.

The baseband supports all features required by Bluetooth 5 specification.

### Packet Format

Packet format in standard 1-Mbps Bluetooth LE mode is shown in Table 3.

Table 3. Packet format in standard 1-Mbps Bluetooth LE mode

LSB	Preamble (1 octet)	Access Address (4 octets)	PDU (2-257 octets)	CRC (3 octets)	MSB
-----	--------------------	---------------------------	--------------------	----------------	-----

Packet length 80 bit–2120 bit (80–2120 μs at 1 Mbps).

Packet format in standard 2-Mbps Bluetooth LE mode is shown in Table 4.

Table 4. Packet format in standard 2-Mbps Bluetooth LE mode

LSB	Preamble (2 octets)	Access Address (4 octets)	PDU (2-257 octets)	CRC (3 octets)	MSB
-----	---------------------	---------------------------	--------------------	----------------	-----

Packet format in standard 500-kbps/125-kbps Bluetooth LE mode is shown in Table 5.

Table 5. Packet format in standard 500-kbps/125-kbps Bluetooth LE mode

LSB	Preamble (10 octets)	Access Address (4 octets)	CI (2 bits)	TERM1 (3 bits)	PDU (2-257 octets)	PDU (2-257 octets)	CRC (3 octets)	TERM2 (3 bits)	MSB
-----	----------------------	---------------------------	-------------	----------------	--------------------	--------------------	----------------	----------------	-----

## RSSI and Frequency Offset

The RYZ012 provides accurate RSSI (Receiver Signal Strength Indicator) and frequency offset indication.

- RSSI can be read from the one byte at the tail of each received data packet.
- If no data packet is received (for example to perform channel energy measurement when no desired signal is present), real-time RSSI can also be read from specific registers which will be updated automatically.
- RSSI monitoring resolution can reach  $\pm 1\text{dB}$ .

Frequency offset can be read from the two bytes at the tail of the data packet. Valid bits of actual frequency offset may be less than 16 bits, and different valid bits correspond to a different tolerance range.

## Ordering Information

**Table 6. Ordering information**

Orderable Part Number	Package	MSL Rating	Shipping Packaging	Ambient Temperature
RYZ012A100FZ00#BD0	Module with internal antenna	3	Tray	-40°C to +85°C
RYZ012A100FZ00#HD0	Module with internal antenna	3	Tape & Reel	-40°C to +85°C
RYZ012B100FZ00#BD0	Module needing external antenna	3	Tray	-40°C to +85°C
RYZ012B100FZ00#HD0	Module needing external antenna	3	Tape & Reel	-40°C to +85°C

## Marking Diagram



**Figure 5. Marking diagram**

## Regulatory Information

This section contains general regulatory information.

### FCC Statement

This device complies with part 15 of the FCC rules. Operation is subject to the following two conditions:

1. This device may not cause harmful interference.
2. This device must accept any interference received, including interference that may cause undesired operation.

This equipment has been tested and found to comply with the limits for a Class B digital device, pursuant to part 15 of the FCC Rules. These limits are designed to provide reasonable protection against harmful interference in an industrial or residential installation. This equipment generates and can radiate radio frequency energy and, if not installed and used in accordance with the instructions, may cause harmful interference. If this equipment does cause harmful interference to radio or television reception, which can be determined by turning the equipment off and on, the user is encouraged to try to correct the interference by one or more of the following measures:

- Reorient or relocate the receiving antenna.
- Increase the separation between the equipment and the receiver.
- Connect the equipment into an outlet on a circuit different from that to which the receiver is connected.
- Consult the dealer or an experienced radio/TV technician for help.

**Caution:** Any changes or modification not expressly approved by the party responsible for compliance could void the user's authority to operate the equipment.

This equipment complies with FCC radiation exposure limits set forth for an uncontrolled environment. This transmitter must be co-located or operating in conjunction with any other antenna and transmitter.

### EU Declaration of Conformity

Integrated Device Technology, a Renesas Corporation company declares that the RYZ012 complies with the essential requirements and other relevant provisions of Directive 2014/53/EU. A copy of the Declaration of Conformity is available on request.

### Japanese Radio Law and Japanese Telecommunications Business Law Compliance

This device is granted pursuant to the Japanese Radio Law (電波法).

This device should not be modified (otherwise the granted designation number will become invalid)

The host product should provide the statement below on its housing:

当該機器には電波法に基づく、技術基準適合証明等を受けた特定無線設備を装着している

(Translation: "This equipment contains specified radio equipment that has been certified to the Technical Regulation Conformity Certification under the Radio Law.")

### Absolute Maximum Ratings

The absolute maximum ratings are stress ratings only. Stresses greater than those listed below can cause permanent damage to the device. Functional operation of the RYZ012 at absolute maximum ratings is not implied. Exposure to absolute maximum rating conditions can affect device reliability.

**Table 7. Absolute maximum ratings**

Symbol	Parameter	Conditions	Minimum	Maximum	Units
$V_{DD}$	Supply voltage	All AVDD, DVDD and VDD_IO pins must have the same voltage	-0.3	3.6	V
$V_{in}$	Voltage on input pin	-	-0.3	$V_{DD} + 0.3$	V
$V_{out}$	Output voltage	-	0	$V_{DD}$	V
$V_{str}$	Storage temperature range	-	-65	150	°C
$V_{sld}$	Soldering temperature	-	-	260	°C

Caution: Stresses above those listed in Table 7 can cause permanent damage to the device. This is a stress-only rating and operation of the device at these or any other conditions above those indicated in the operational sections of this specification is not implied.

### Recommended Operating Conditions

**Table 8. Recommended operating conditions**

Symbol	Parameter	Conditions	Minimum	Typical	Maximum	Units
$V_{DD}$	Power supply voltage	-	1.8	3.3	3.6	V
$t_R$	Supply Rise Time (from 1.6 V to 1.8 V)	-	-	-	10	ms
$t_{Opr}$	Operating Temperature Range	-	-40	-	85	°C

## Electrical Characteristics

**Table 9. Electrical Characteristics**

Symbol	Parameter	Conditions	Minimum	Typical	Maximum	Units
IRx	RX current	Whole chip		5.3	-	mA
ITx	TX current	Whole chip at 0dBm with DCDC		4.8	-	mA
IDeep1	Deep sleep with 8-kB SRAM retention	-	-	1	3.1	uA
	Deep sleep with 16-kB SRAM retention	-	-	1.2	3.3	uA
	Deep sleep with 32-kB SRAM retention	-	-	1.4	3.5	uA
IDeep2	Deep sleep without SRAM retention	-	-	0.4	-	uA

**Table 10. AC Characteristics (VDD = 3.3V, TA = 25°C) (1 of 2)**

Symbol	Parameter	Conditions	Minimum	Typical	Typical	Units
<b>Inputs/Outputs</b>						
V <sub>IH</sub>	Input High Voltage	-	0.7V <sub>DD</sub>	-	V <sub>DD</sub>	V
V <sub>IL</sub> Digital	Input Low Voltage	-	V <sub>SS</sub>	-	0.3V <sub>DD</sub>	V
<b>Digital Inputs/Outputs</b>						
V <sub>OH</sub>	Output High Voltage	-	0.9V <sub>DD</sub>	-	V <sub>DD</sub>	V
V <sub>OL</sub>	Output Low Voltage	-	V <sub>SS</sub>	-	0.1V <sub>DD</sub>	V
<b>RF Parameters</b>						
-	RF Frequency Range	Programmable in 1MHz step	2380	-	2500	MHz
-	Data Rate	Bluetooth LE/2.4G Proprietary 1 Mbps, ±250-kHz deviation				
-		Bluetooth LE/2.4G Proprietary 2 Mbps, ±500-kHz deviation				
-		Bluetooth LE 125 kbps, ±250-kHz deviation				
-		Bluetooth LE 500 kbps, ±250-kHz deviation				
<b>RSSI</b>						
-	RSSI Range	-	-100		10	dBm
-	Resolution	-	-	1	-	dB

**Table 11. Bluetooth LE, 1-Mbps Mode**

Symbol	Parameter	Conditions	Minimum	Typical	Maximum	Units
<b>RX Performance*1 (±250kHz Deviation)</b>						
1 Mbps	Sensitivity	-	-	-96	-	dBm
-	Frequency Offset Tolerance	-	-250	-	+300	kHz
-	Co-channel Rejection	Wanted signal at -67dBm	-	11	-	dB
+1/-1 MHz offset	In-band Blocking Rejection (Equal Modulation Interference)	Wanted signal at -67dBm	-	-1/-3	-	dB
+2/-2 MHz offset			-	-37/-39	-	dB



>=3 MHz offset	In-band Blocking Rejection (Equal Modulation Interference)	Wanted signal at -67dBm	-	-42	-	dB
-	Image Rejection	Wanted signal at -67dBm	-	-37	-	dB
<b>TX Performance</b>						
-	Output Power, Maximum Setting	-	-	10	12	dBm
-	Output power, Minimum Setting	-	-	-45	-	dBm
-	Programmable Output Power range	-	55	dB	-	
-	Modulation 20dB Bandwidth	-	-	1.4	-	MHz

Note 1. For actual sensitivity level of Bluetooth LE 1-Mbps mode, see Bluetooth 5 specification.

**Table 12. Bluetooth LE, 2 Mbps Mode**

Symbol	Parameter	Conditions	Minimum	Typical	Maximum	Units
<b>RX performance*1 (±500kHz Deviation)</b>						
2Mbps	Sensitivity	-	-	-93	-	dBm
-	Frequency Offset Tolerance	-	-300	-	+200	kHz
-	Co-channel Rejection	Wanted signal at - 67dBm	-	10	-	dB
+2/-2 MHz offset	In-band Blocking Rejection	Wanted signal at - 67dBm	-	-6/-6	-	dB
+4/-4 MHz offset			-	-39/-38	-	dB
>4MHz offset			-	-42	-	dB
-	Image Rejection	Wanted signal at - 67dBm	-	-25	--	dB
<b>TX Performance</b>						
-	Output Power, Maximum Setting	-	-	10	12	dBm
-	Output Power, Minimum Setting	-	-	-45	-	dBm
-	Programmable Output Power Range	-	55	dB	-	
-	Modulation 20dB Bandwidth	-	-	2.5	-	MHz

Note 1. For actual sensitivity level of Bluetooth LE 2Mbps mode, see Bluetooth 5 specification.

**Table 13. Bluetooth LE, 500-kbps Mode**

Symbol	Parameter	Condition s	Minimum	Typical	Maximum	Units
<b>RX Performance*1 (±250-kHz Deviation)</b>						
500 kbps	Sensitivity	-	-	-99	-	dBm
-	Frequency Offset Tolerance	-	-150	-	+50	kHz
-	Co-channel Rejection	Wanted signal	-	1	-	dB

		at -67dBm				
+1/-1 MHz offset	In-band Blocking Rejection (Equal Modulation Interference)	Wanted signal at -67dBm	-	-34/-36	-	dB
+2/-2 MHz offset			-	-42/-42	-	dB
>3MHz offset			-	-42	-	dB
	Image Rejection	Wanted signal at -67dBm	-	-42	-	dB

**TX Performance**

-	Output Power, Maximum Setting	-	-	10	12	dBm
-	Output Power, Minimum Setting	-	-	-45	-	dBm
-	Programmable Output Power Range	-	55	dB		
-	Modulation 20dB Bandwidth	-	-	1.4	-	MHz

Note 1. For actual sensitivity level of Bluetooth LE 500-kbps mode, see Bluetooth 5 specification.

**Table 14. BLE, 125-kbps Mode**

Symbol	Parameter	Conditions	Minimum	Typical	Maximum	Units
<b>RX Performance*1 (±250kHz Deviation)</b>						
125 kbps	Sensitivity	-	-	-101	-	dBm
-	Frequency Offset Tolerance	-	-150	-	+50	kHz
-	Co-channel Rejection	Wanted signal at -67dBm	-	3	-	dB
+1/-1 MHz offset	In-band Blocking Rejection (Equal Modulation Interference)	Wanted signal at -67dBm	-	-32/-34	-	dB
+2/-2 MHz offset			-	-42/-42	-	dB
>=3 MHz offset			-	-42	-	dB
-	Image Rejection	Wanted signal at -67dBm	-	-42	-	dB
<b>TX Performance</b>						
-	Output Power, Maximum Setting	-	-	10	12	dBm
-	Output Power, Minimum Setting	-	-	-45	-	dBm
-	Programmable Output Power Range	-	55	dB		
-	Modulation 20dB Bandwidth	-	-	1.4	-	MHz

Note 1. For actual sensitivity level of Bluetooth LE 125-kbps mode, see Bluetooth 5 specification.

## Package Dimensions

### Package Outline Drawings

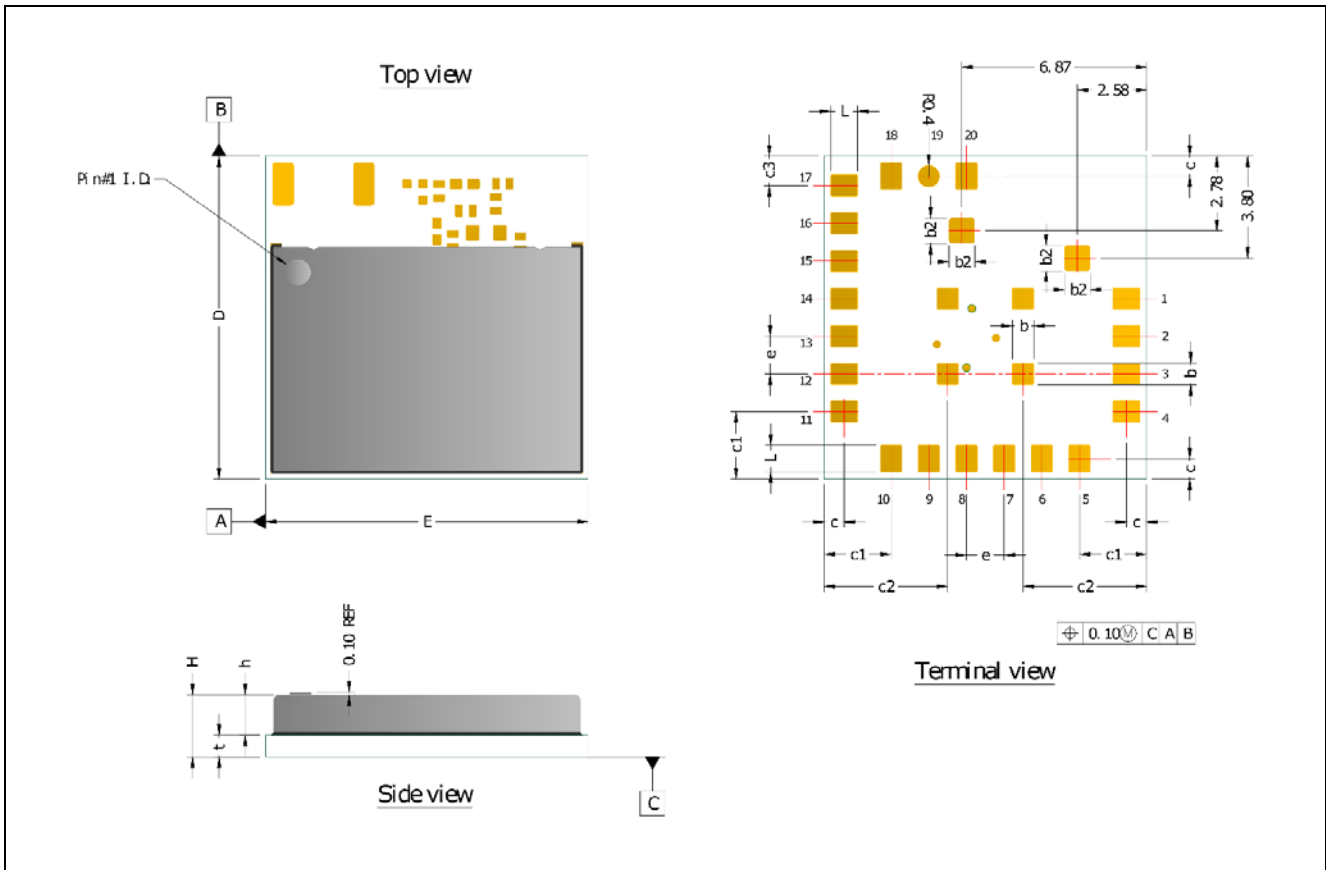

Figure 6. Package outline drawings

Table 15. Module dimensions

In mm	Min.	Nom.	Max
D	11.85	12.00	12.15
E	11.85	12.00	12.15
b	0.7	0.8	0.9
b2	0.96		
L	0.9	1.00	1.1
e	1.4		
c	0.75		
c1	2.5		
c2	4.6		
c3	1.1		
H	2.16	2.31	2.46
t	0.71	0.81	0.91

## Soldering Information

The recommended soldering profile for a lead-free (RoHS-compliant) process is shown in Figure 7.

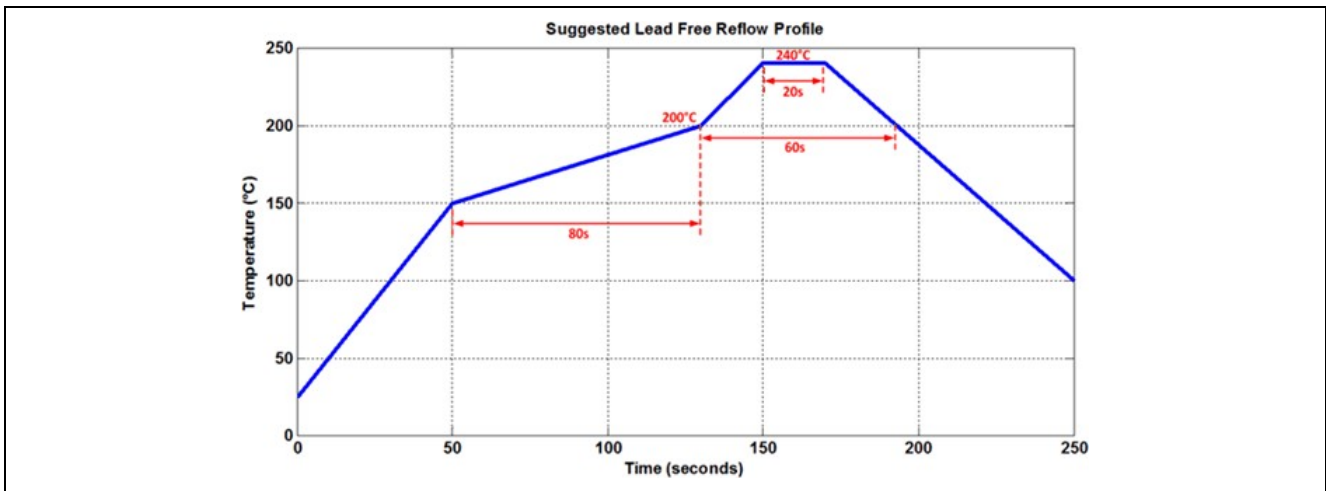

**Figure 7. Recommended soldering profile**

It is important to ensure this temperature profile is measured at the sensor itself. Measuring the profile at a larger component with a higher thermal mass results in the temperature at the small sensor measuring higher than expected. For manual soldering, the contact time must be limited to 5 seconds with a maximum iron temperature of 350°C. It is strongly recommended that a no-clean solder paste is used to avoid the need to wash the PCB.

## Integration Instructions

Module integrators must adhere to the integration guidelines given to maintain compliance with the certification requirements while providing the maximum performance.

**Note:** Any modifications to the RYZ012 modules are not allowed and may void the user's permission to operate the module.

### List of applicable FCC / ISED rules

FCC	ISED
47 CFR Part 15 Subpart C §15.247	RSS-247, Issue 2, February 2017

## Specific Operational Use Conditions

### North America (FCC)

The module must not be operated at power levels above 10.0 dBm. Host devices that need higher output power may not be marketed without prior re-certification.

### Europe (RED)

The module must not be operated at power levels above 8.4 dBm. Host devices that need higher output power may not be marketed in regions covered by RED regulation without prior re-certification.

### Japan (MIC)

The module must be operated at power level 4.5 dBm. Host devices that need change output power may not be marketed without prior re-certification.

**Layout Guidelines**

**RYZ012A1**

Place the module close to the board corner. Do not place any metal in the keep-out area (no traces, planes, components, batteries, screws ...). Ensure that the module is properly connected to ground (for example, ground plane)

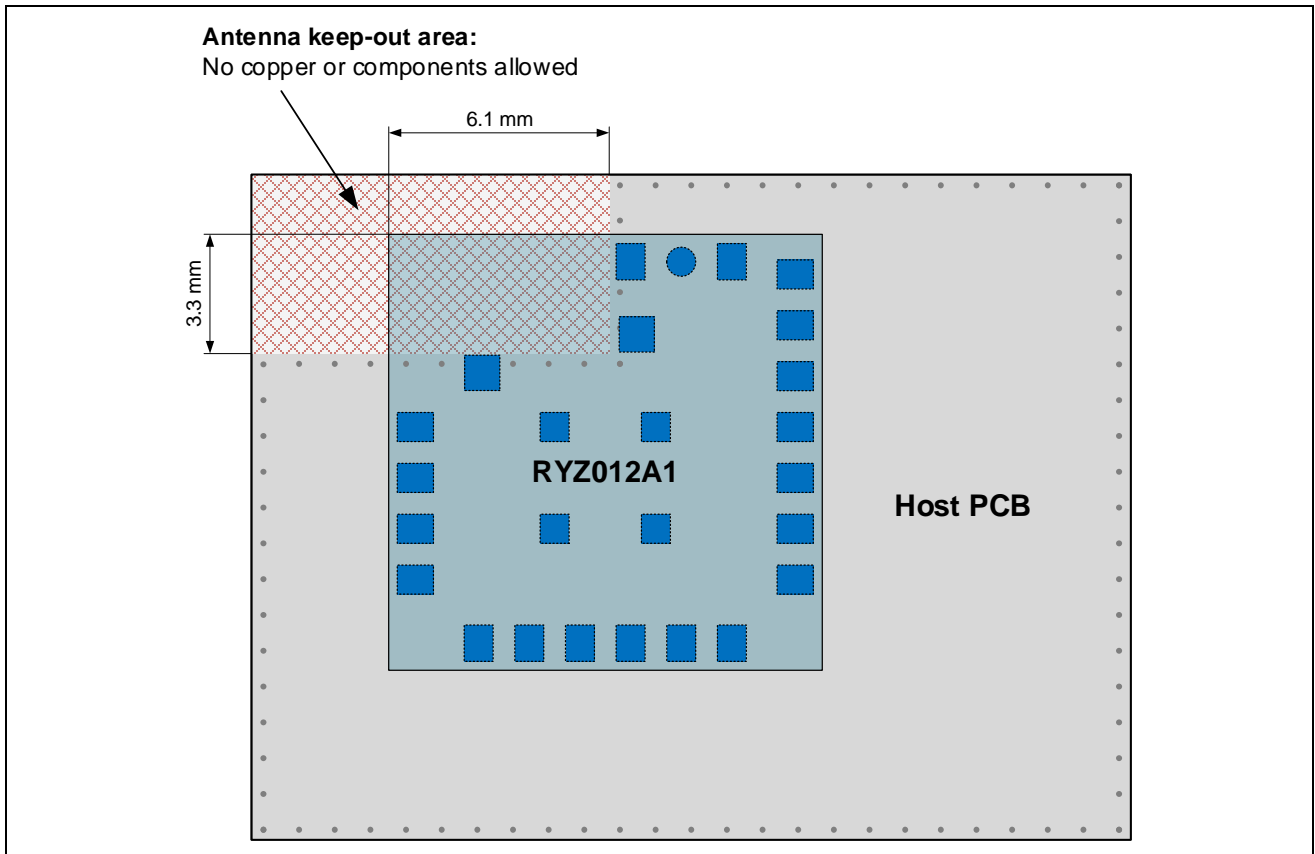

**Figure 8. RYZ012A1 Layout Guideline**

**RZY012B1**

Do not place any metal in the keep-out area (no traces, planes, components, batteries, screws ...). Ensure the module is properly connected to ground (for example, ground plane). Ensure the antenna connection trace is 50Ω matched to achieve proper antenna performance.

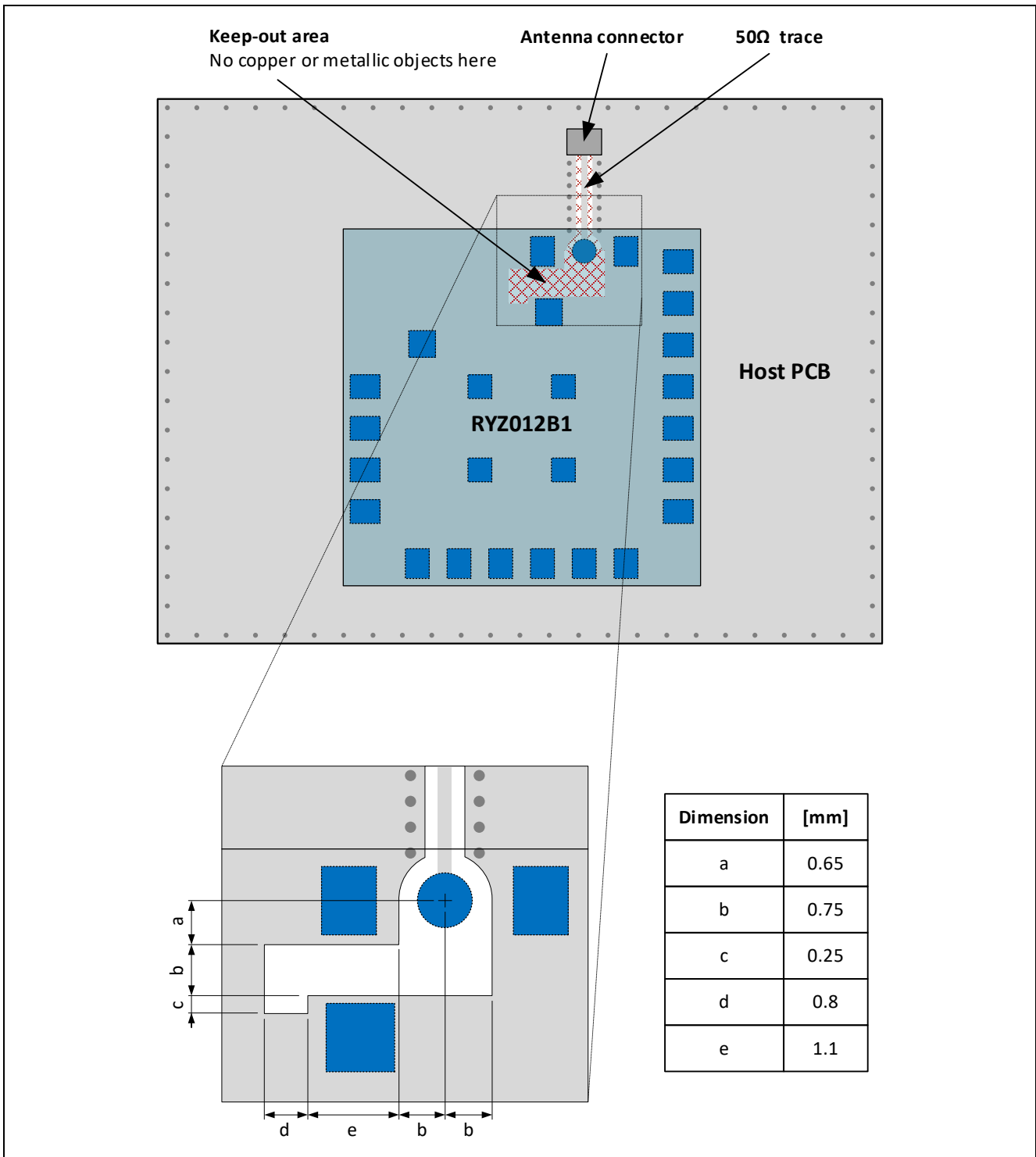

**Figure 9. RZY012B1 Layout Guideline**

## Antenna Trace Design

The antenna trace connecting the modules RF pad with the antenna connector must be designed to have 50 Ohms impedance. The impedance of the trace depends on different parameters such as the dielectric constant, trace width and height and distances to ground planes. The integrator should use a calculator such as AWR TXLine to compute the exact geometry of the antenna trace. The picture below shows an exemplary configuration for a Coplanar Wave Guide antenna trace with  $\epsilon_r = 4.7$  and 1 mm substrate height.

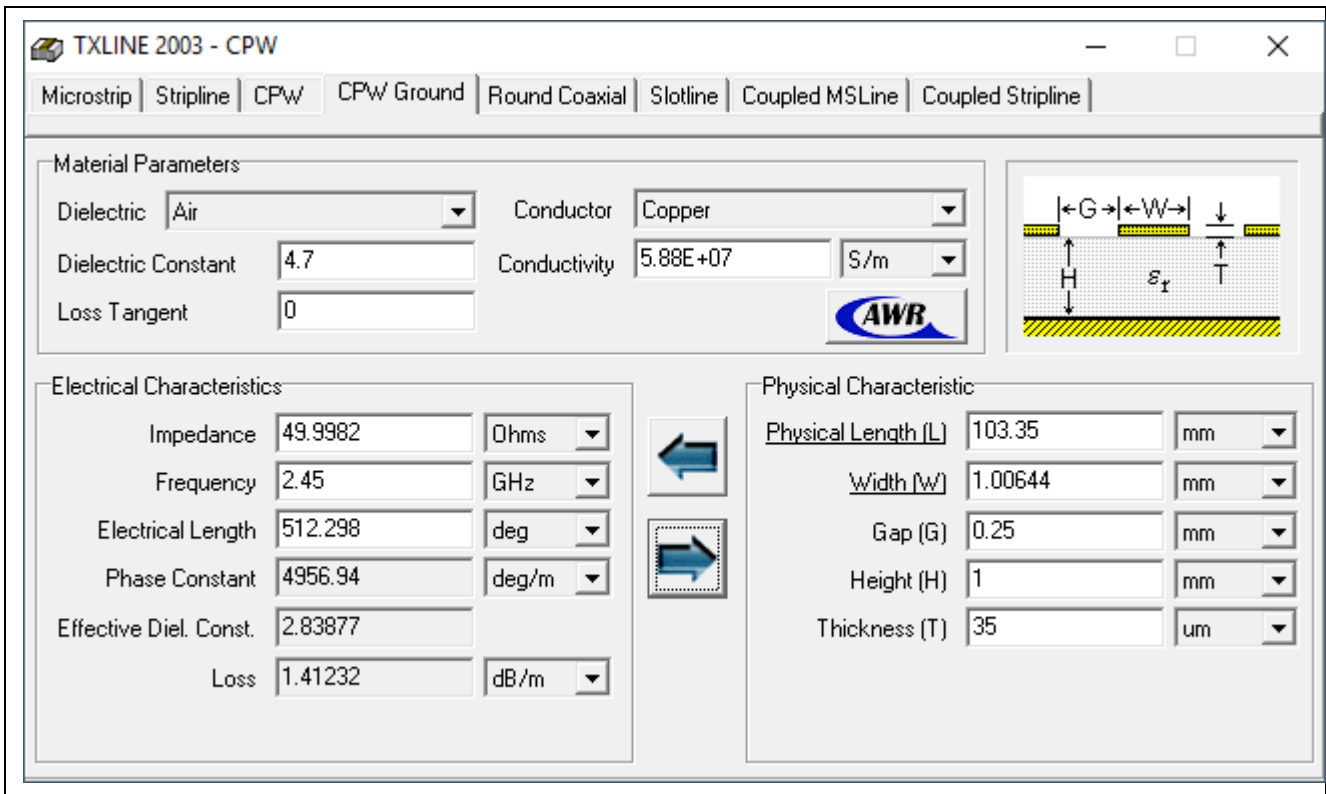

Figure 10. AWR TXLine Tool for Antenna Trace Impedance Calculation

## Antennas

### RYZ012A1

The RYZ012A1 has an integrated antenna. The host integrator should follow the instructions from to ensure best antenna performance.

### RYZ012B1

The RYZ012B1 does not have an own antenna, but comes with an antenna pad instead. The antenna must be provided by the host device. Please strictly follow the integration instructions given to ensure proper antenna performance.

RYZ012B1 has been certified in all regions with antenna model

### PulseLarsen W1095K

Which is a monopole antenna with 1 dBi gain.

### FCC/ISED (North America)

FCC/ISED covered regions allow the use of other monopole antennas with less than 1dBi gain. Antennas which do not fulfill both requirements must be tested before they may be used with the module. Please contact Renesas for further information.

**Important Notice:** If the antenna is not fixed to the device, the antenna connector must be unique (non-standard). One type of antenna connector that fulfils this requirement is the Reverse SMA connector.

**RED (Europe)**

Any design should undergo radiated RF measurements, regardless of the antenna being used (including the original antenna). It is recommended to use a professional test house for these measurements.

**MIC (Japan)**

The antenna noted may be used without any further measurements. Any other antenna requires antenna pattern measurements and listing with the MIC. Please contact Renesas for further information.

**RF Exposure Considerations**

This product complies with the FCC/IC RF exposure limits set for mobile applications. That means, the product may be used in applications that have more than 20cm distance from the human body.

**Labeling Requirements****FCC (US)**

Host devices integrating the RYZ012 should indicate the use of this module on a label on the host device by the following statement:

Contains FCC-ID: COR-RYZ012X1

In addition, the host device should include the following text on the label (if possible):

This device complies with part 15 of the FCC rules. Operation is subject to the following two conditions.  
(1) This device may not cause harmful interference  
(2) This device must accept any interference received, including interference that may cause undesired operation.

Caution: Any Changes or modifications not expressly approved by the party responsible for compliance could void the user's authority to operate the equipment.

If above statement cannot be included on the host device label, this statement must be included in the user's manual of the host device.

**ISED (Canada)**

Host devices integrating the RYZ012 should indicate the use of this module on a label on the host device by the following statement:

Contains IC: 24477-RYZ012X1

In addition, the host device should include the following text on the label (if possible):

This device complies with Industry Canada license-exempt RSS standard(s). Operation is subject to the following two conditions:  
(1) this device may not cause interference, and  
(2) this device must accept any interference, including interference that may cause undesired operation of the device.

Le présent appareil est conforme aux CNR d'Industrie Canada applicables aux appareils radio exempts de licence. L'exploitation est autorisée aux deux conditions suivantes :

- (1) l'appareil ne doit pas produire de brouillage, et
- (2) l'utilisateur de l'appareil doit accepter tout brouillage radioélectrique subi, même si le brouillage est susceptible d'en compromettre le fonctionnement.

If above statement cannot be included on the host device label, this statement must be included in the user's manual of the host device.





## Appendix 1. Related Documents

Component	Document Type	Description
Microcontrollers	Datasheet	Features, overview, and electrical characteristics of the MCU
	User's Manual: Hardware	MCU specifications such as pin assignments, memory maps, peripheral functions, electrical characteristics, timing diagrams, and operation descriptions
	Application Notes	Technical notes, board design guidelines, and software migration information
	Technical Update (TU)	Preliminary reports on product specifications such as restrictions and errata
Software	User's Manual: Software	Command set, API reference, and programming information
	Application Notes	Project files, guidelines for software programming, and application examples to develop embedded software applications
Tools & Kits, Solutions	User's Manual: Development Tools	User's manuals and quick start guides for developing embedded software applications with Software Packages, Development Kits, Starter Kits, Promotion Kits, Product Examples, and Application Examples
	Quick Start Guide	
	Application Notes	Project files, guidelines for software programming, and application examples for developing embedded software applications

**Revision History**

Rev.	Date	Description	
		Page	Summary
1.00	Jul.15.21	—	Initial version (RYZ012A1/RYZ012B1)
1.01	May.05.22	—	Minor updates

# General Precautions in the Handling of Microprocessing Unit and Microcontroller Unit Products

The following usage notes are applicable to all Microprocessing unit and Microcontroller unit products from Renesas. For detailed usage notes on the products covered by this document, refer to the relevant sections of the document as well as any technical updates that have been issued for the products.

## 1. Precaution against Electrostatic Discharge (ESD)

A strong electrical field, when exposed to a CMOS device, can cause destruction of the gate oxide and ultimately degrade the device operation. Steps must be taken to stop the generation of static electricity as much as possible, and quickly dissipate it when it occurs. Environmental control must be adequate. When it is dry, a humidifier should be used. This is recommended to avoid using insulators that can easily build up static electricity.

Semiconductor devices must be stored and transported in an anti-static container, static shielding bag or conductive material. All test and measurement tools including work benches and floors must be grounded. The operator must also be grounded using a wrist strap. Semiconductor devices must not be touched with bare hands. Similar precautions must be taken for printed circuit boards with mounted semiconductor devices.

## 2. Processing at power-on

The state of the product is undefined at the time when power is supplied. The states of internal circuits in the LSI are indeterminate and the states of register settings and pins are undefined at the time when power is supplied. In a finished product where the reset signal is applied to the external reset pin, the states of pins are not guaranteed from the time when power is supplied until the reset process is completed. In a similar way, the states of pins in a product that is reset by an on-chip power-on reset function are not guaranteed from the time when power is supplied until the power reaches the level at which resetting is specified.

## 3. Input of signal during power-off state

Do not input signals or an I/O pull-up power supply while the device is powered off. The current injection that results from input of such a signal or I/O pull-up power supply may cause malfunction and the abnormal current that passes in the device at this time may cause degradation of internal elements. Follow the guideline for input signal during power-off state as described in your product documentation.

## 4. Handling of unused pins

Handle unused pins in accordance with the directions given under handling of unused pins in the manual. The input pins of CMOS products are generally in the high-impedance state. In operation with an unused pin in the open-circuit state, extra electromagnetic noise is induced in the vicinity of the LSI, an associated shoot-through current flows internally, and malfunctions occur due to the false recognition of the pin state as an input signal become possible.

## 5. Clock signals

After applying a reset, only release the reset line after the operating clock signal becomes stable. When switching the clock signal during program execution, wait until the target clock signal is stabilized. When the clock signal is generated with an external resonator or from an external oscillator during a reset, ensure that the reset line is only released after full stabilization of the clock signal. Additionally, when switching to a clock signal produced with an external resonator or by an external oscillator while program execution is in progress, wait until the target clock signal is stable.

## 6. Voltage application waveform at input pin

Waveform distortion due to input noise or a reflected wave may cause malfunction. If the input of the CMOS device stays in the area between  $V_{IL}$  (Max.) and  $V_{IH}$  (Min.) due to noise, for example, the device may malfunction. Take care to prevent chattering noise from entering the device when the input level is fixed, and also in the transition period when the input level passes through the area between  $V_{IL}$  (Max.) and  $V_{IH}$  (Min.).

## 7. Prohibition of access to reserved addresses

Access to reserved addresses is prohibited. The reserved addresses are provided for possible future expansion of functions. Do not access these addresses as the correct operation of the LSI is not guaranteed.

## 8. Differences between products

Before changing from one product to another, for example to a product with a different part number, confirm that the change will not lead to problems. The characteristics of a microprocessing unit or microcontroller unit products in the same group but having a different part number might differ in terms of internal memory capacity, layout pattern, and other factors, which can affect the ranges of electrical characteristics, such as characteristic values, operating margins, immunity to noise, and amount of radiated noise. When changing to a product with a different part number, implement a system-evaluation test for the given product.

## Notice

1. Descriptions of circuits, software and other related information in this document are provided only to illustrate the operation of semiconductor products and application examples. You are fully responsible for the incorporation or any other use of the circuits, software, and information in the design of your product or system. Renesas Electronics disclaims any and all liability for any losses and damages incurred by you or third parties arising from the use of these circuits, software, or information.
2. Renesas Electronics hereby expressly disclaims any warranties against and liability for infringement or any other claims involving patents, copyrights, or other intellectual property rights of third parties, by or arising from the use of Renesas Electronics products or technical information described in this document, including but not limited to, the product data, drawings, charts, programs, algorithms, and application examples.
3. No license, express, implied or otherwise, is granted hereby under any patents, copyrights or other intellectual property rights of Renesas Electronics or others.
4. You shall be responsible for determining what licenses are required from any third parties, and obtaining such licenses for the lawful import, export, manufacture, sales, utilization, distribution or other disposal of any products incorporating Renesas Electronics products, if required.
5. You shall not alter, modify, copy, or reverse engineer any Renesas Electronics product, whether in whole or in part. Renesas Electronics disclaims any and all liability for any losses or damages incurred by you or third parties arising from such alteration, modification, copying or reverse engineering.
6. Renesas Electronics products are classified according to the following two quality grades: "Standard" and "High Quality". The intended applications for each Renesas Electronics product depends on the product's quality grade, as indicated below.
  - "Standard": Computers; office equipment; communications equipment; test and measurement equipment; audio and visual equipment; home electronic appliances; machine tools; personal electronic equipment; industrial robots; etc.
  - "High Quality": Transportation equipment (automobiles, trains, ships, etc.); traffic control (traffic lights); large-scale communication equipment; key financial terminal systems; safety control equipment; etc.

Unless expressly designated as a high reliability product or a product for harsh environments in a Renesas Electronics data sheet or other Renesas Electronics document, Renesas Electronics products are not intended or authorized for use in products or systems that may pose a direct threat to human life or bodily injury (artificial life support devices or systems; surgical implantations; etc.), or may cause serious property damage (space system; undersea repeaters; nuclear power control systems; aircraft control systems; key plant systems; military equipment; etc.). Renesas Electronics disclaims any and all liability for any damages or losses incurred by you or any third parties arising from the use of any Renesas Electronics product that is inconsistent with any Renesas Electronics data sheet, user's manual or other Renesas Electronics document.
7. No semiconductor product is absolutely secure. Notwithstanding any security measures or features that may be implemented in Renesas Electronics hardware or software products, Renesas Electronics shall have absolutely no liability arising out of any vulnerability or security breach, including but not limited to any unauthorized access to or use of a Renesas Electronics product or a system that uses a Renesas Electronics product. RENESAS ELECTRONICS DOES NOT WARRANT OR GUARANTEE THAT RENESAS ELECTRONICS PRODUCTS, OR ANY SYSTEMS CREATED USING RENESAS ELECTRONICS PRODUCTS WILL BE INVULNERABLE OR FREE FROM CORRUPTION, ATTACK, VIRUSES, INTERFERENCE, HACKING, DATA LOSS OR THEFT, OR OTHER SECURITY INTRUSION ("Vulnerability Issues"). RENESAS ELECTRONICS DISCLAIMS ANY AND ALL RESPONSIBILITY OR LIABILITY ARISING FROM OR RELATED TO ANY VULNERABILITY ISSUES. FURTHERMORE, TO THE EXTENT PERMITTED BY APPLICABLE LAW, RENESAS ELECTRONICS DISCLAIMS ANY AND ALL WARRANTIES, EXPRESS OR IMPLIED, WITH RESPECT TO THIS DOCUMENT AND ANY RELATED OR ACCOMPANYING SOFTWARE OR HARDWARE, INCLUDING BUT NOT LIMITED TO THE IMPLIED WARRANTIES OF MERCHANTABILITY, OR FITNESS FOR A PARTICULAR PURPOSE.
8. When using Renesas Electronics products, refer to the latest product information (data sheets, user's manuals, application notes, "General Notes for Handling and Using Semiconductor Devices" in the reliability handbook, etc.), and ensure that usage conditions are within the ranges specified by Renesas Electronics with respect to maximum ratings, operating power supply voltage range, heat dissipation characteristics, installation, etc. Renesas Electronics disclaims any and all liability for any malfunctions, failure or accident arising out of the use of Renesas Electronics products outside of such specified ranges.
9. Although Renesas Electronics endeavors to improve the quality and reliability of Renesas Electronics products, semiconductor products have specific characteristics, such as the occurrence of failure at a certain rate and malfunctions under certain use conditions. Unless designated as a high reliability product or a product for harsh environments in a Renesas Electronics data sheet or other Renesas Electronics document, Renesas Electronics products are not subject to radiation resistance design. You are responsible for implementing safety measures to guard against the possibility of bodily injury, injury or damage caused by fire, and/or danger to the public in the event of a failure or malfunction of Renesas Electronics products, such as safety design for hardware and software, including but not limited to redundancy, fire control and malfunction prevention, appropriate treatment for aging degradation or any other appropriate measures. Because the evaluation of microcomputer software alone is very difficult and impractical, you are responsible for evaluating the safety of the final products or systems manufactured by you.
10. Please contact a Renesas Electronics sales office for details as to environmental matters such as the environmental compatibility of each Renesas Electronics product. You are responsible for carefully and sufficiently investigating applicable laws and regulations that regulate the inclusion or use of controlled substances, including without limitation, the EU RoHS Directive, and using Renesas Electronics products in compliance with all these applicable laws and regulations. Renesas Electronics disclaims any and all liability for damages or losses occurring as a result of your noncompliance with applicable laws and regulations.
11. Renesas Electronics products and technologies shall not be used for or incorporated into any products or systems whose manufacture, use, or sale is prohibited under any applicable domestic or foreign laws or regulations. You shall comply with any applicable export control laws and regulations promulgated and administered by the governments of any countries asserting jurisdiction over the parties or transactions.
12. It is the responsibility of the buyer or distributor of Renesas Electronics products, or any other party who distributes, disposes of, or otherwise sells or transfers the product to a third party, to notify such third party in advance of the contents and conditions set forth in this document.
13. This document shall not be reprinted, reproduced or duplicated in any form, in whole or in part, without prior written consent of Renesas Electronics.
14. Please contact a Renesas Electronics sales office if you have any questions regarding the information contained in this document or Renesas Electronics products.

(Note1) "Renesas Electronics" as used in this document means Renesas Electronics Corporation and also includes its directly or indirectly controlled subsidiaries.

(Note2) "Renesas Electronics product(s)" means any product developed or manufactured by or for Renesas Electronics.

(Rev.5.0-1 October 2020)

## Corporate Headquarters

TOYOSU FORESIA, 3-2-24 Toyosu,  
Koto-ku, Tokyo 135-0061, Japan  
[www.renesas.com](http://www.renesas.com)

## Trademarks

Renesas and the Renesas logo are trademarks of Renesas Electronics Corporation. All trademarks and registered trademarks are the property of their respective owners.

## Contact information

For further information on a product, technology, the most up-to-date version of a document, or your nearest sales office, please visit:  
[www.renesas.com/contact/](http://www.renesas.com/contact/).