

REVISIONS					
P	LR	DESCRIPTION	DATE	DMN	APVD
C4		PCN-22-157376	14NOV2022	M.C.H.L	

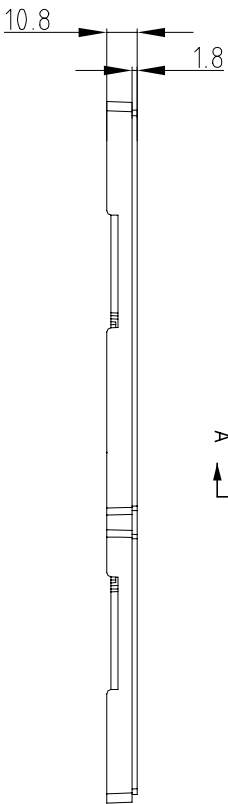
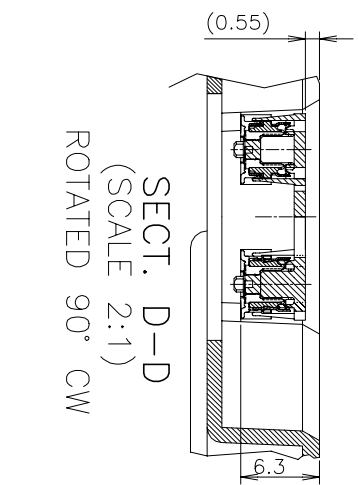
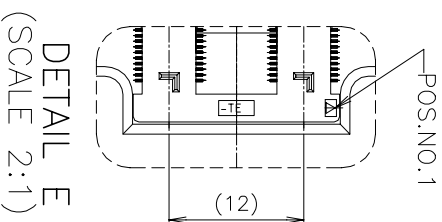
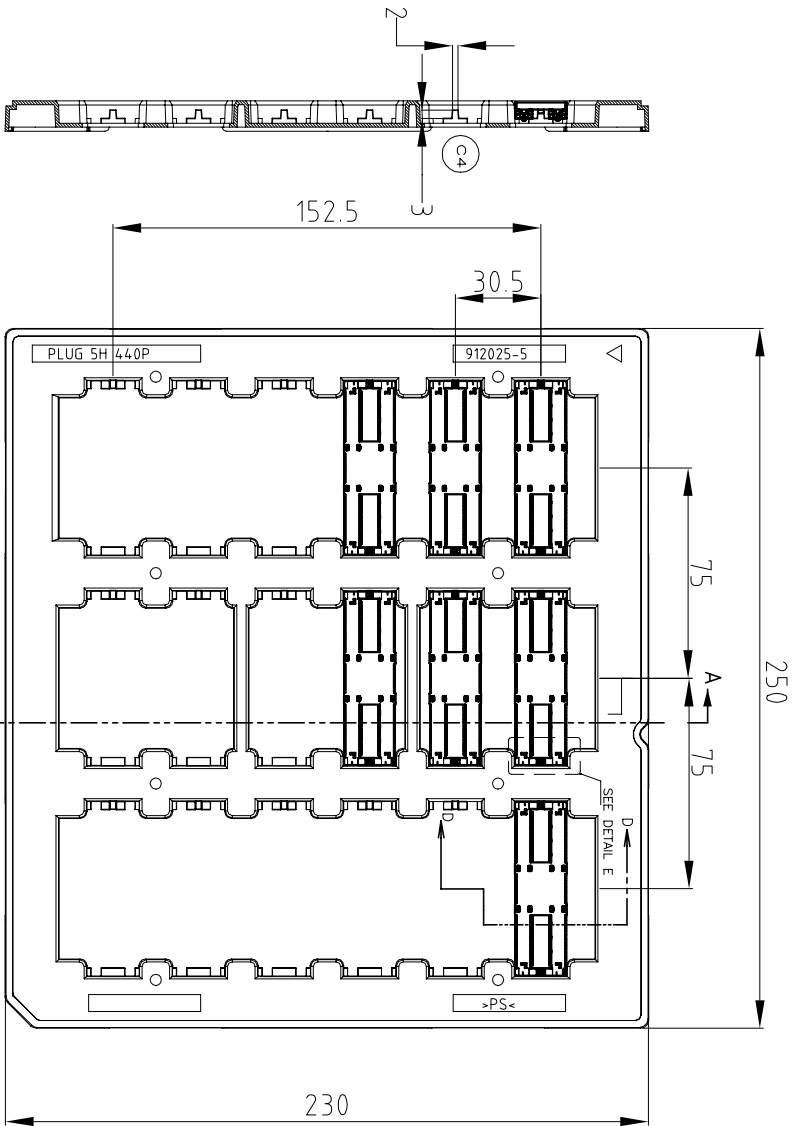

THIS DRAWING IS A CONTROLLED DOCUMENT.

DIMENSIONS:	MM	TOLERANCES UNLESS OTHERWISE SPECIFIED:
0 PLG		± 0.25
1 PLG		± 0.15
2 PLG		± 0.10
3 PLG		± 0.05
4 PLG		± 0.0250
ANGLES		± 3°

DMN	18MAY05	S. CHIEN
CHK	18MAY05	T. FUJITSUGI
APVD	18MAY05	W. KODAMA
PRODUCT SPEC		108-5560
APPLICATION SPEC		
WEIGHT		

MATERIAL		FINISH
CUSTOMER DRAWING		

NO	3	18	75	440	9-1827233-6
SEALANT	ROW	QTY	A	POS.	PART NO.
					3-1827233-6

STE TE Connectivity Ltd.

HARD TRAY ASSY
FH 0.5 BTB CONNECTOR 440POS
PLUG 5H W/G-PLATE ON 2 ROW CAP

SIZE	A3	CAGE CODE	00779	DRAWING NO.	1827233	RESTRICTED TO
SCALE	1:2	SHEET	1	OF	4	REV
						C4

REVISIONS		DATE	DMN	APVD
P	LTR			
-	SEE SHEET 1			

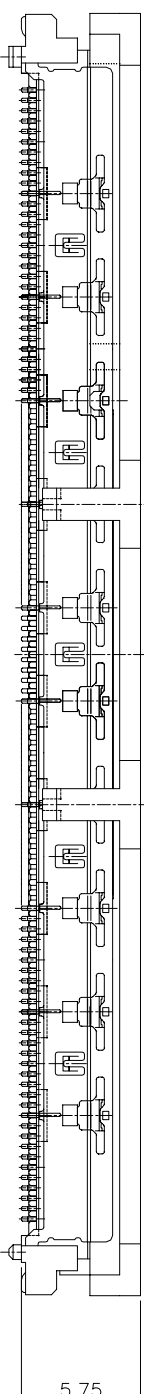
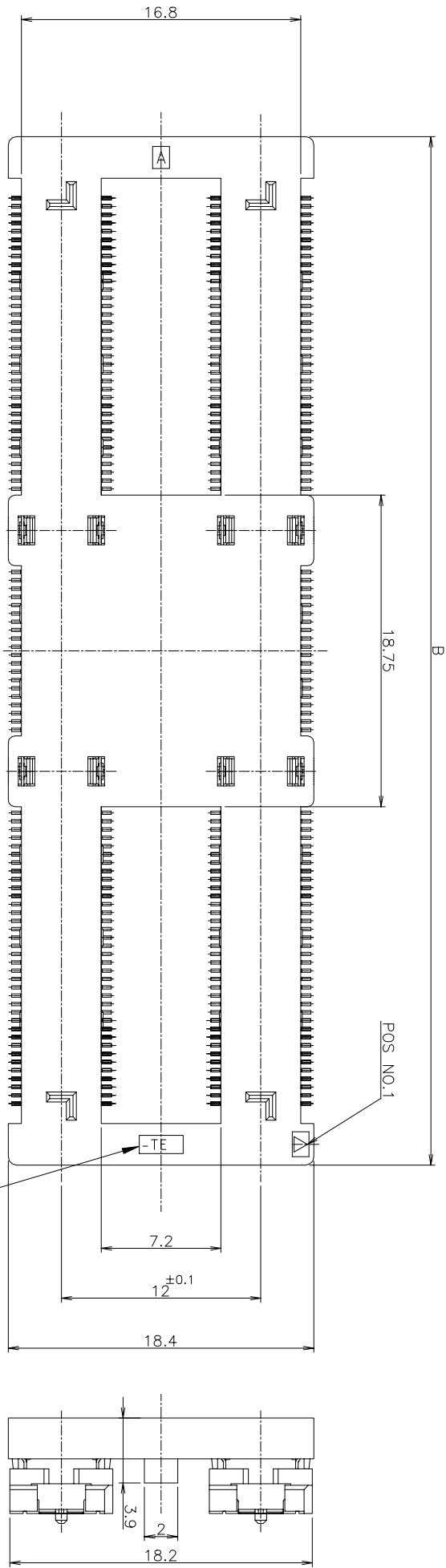

NOTE
 ▲ SINK SURFACE 0.1, RISING CHARACTER 0.08
 ' -TE ' MANUFACTURED BY TE JP
 ' -TE - ' MANUFACTURED BY TE QD

THIS DRAWING IS A CONTROLLED DOCUMENT.

DIMENSIONS:	TOLERANCES UNLESS OTHERWISE SPECIFIED:
MM	

0 PLC	± 0.25
1 PLC	± 0.15
2 PLC	± 0.10
3 PLC	± 0.05
4 PLC ANGLES	± 0.0250
	± .3°

DIM	CHK	APVD	PRODUCT SPEC	APPLICATION SPEC	WEIGHT
-	-	-	-	-	-

STE TE Connectivity Ltd.

HARD TRAY ASSY
 FH 0.5 BTB CONNECTOR 440POS
 PLUG 5H W/G-PLATE ON 2 ROW CAP

NAME	SIZE	CAGE CODE	DRAWING NO.	RESTRICTED TO
A3	00779	1827233		

BLACK	61.9	440	9-1827233-6
CAP COLOR	B	POS	3-1827233-6
		PART NO.	

CUSTOMER DRAWING	SCALE	SHEET	REV
	4:1	2 OF 4	C4

REVISIONS			
P	LR	DESCRIPTION	DATE
-	-	SEE SHEET 1	-

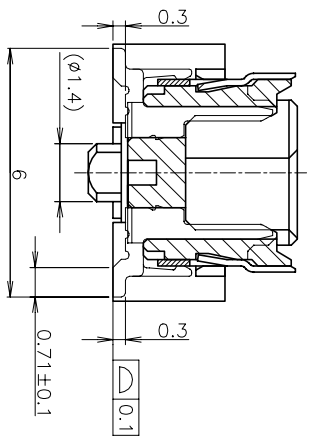
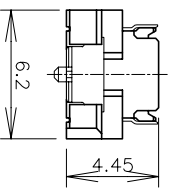
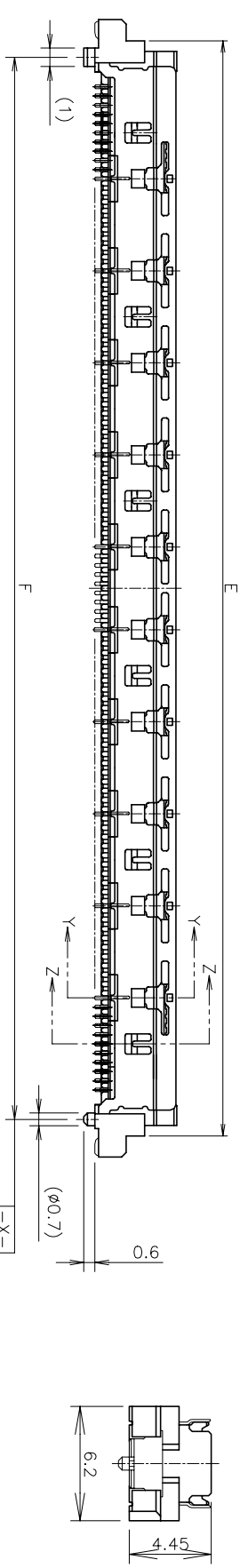
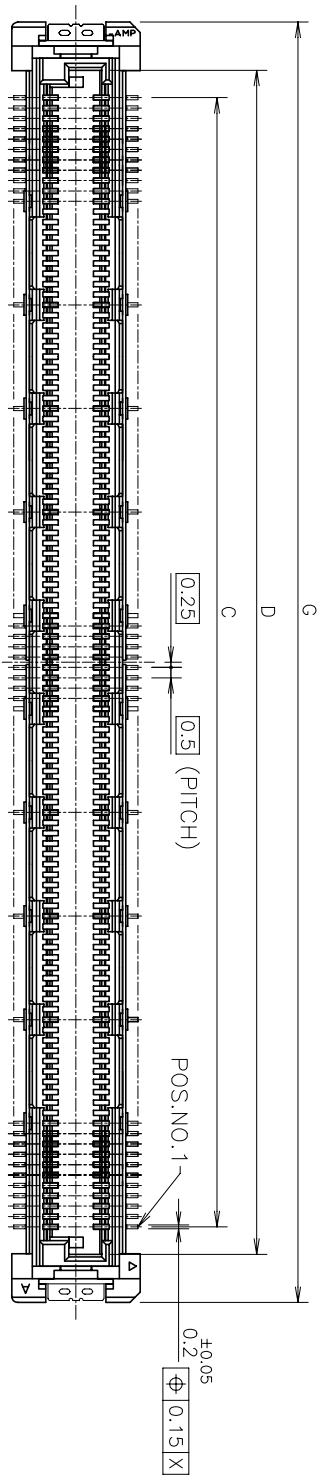

SECT. Z-Z
(SIGNAL POSITION)
(SCALE 8:1)

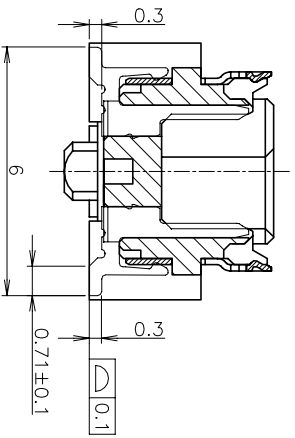

SECT. Y-Y
(GROUND POSITION)
(SCALE 8:1)

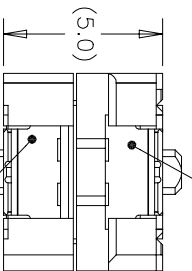

PLUG CONNECTOR
P/N: *-1827233-*
REG CONNECTOR
P/N: *-1827231-*
FULL-MATED CONDITION

FINISH	G	F	E	D	C	POS.	HSG COLOR	PART NO.
△	61.8	57.7	59.5	57.1	54.5	440	BLACK	9-1827233-6
△								3-1827233-6

NOTES

△ MATERIAL:
HOUSING : HIGH TEMP THERMO PLASTIC UL94V-0
CONTACT : COPPER ALLOY
SOLDER PEG : COPPER ALLOY

△ FINISH:
SIGNAL & GROUND CONTACT :
UNDER PLATE Ni 0.0013mm MIN ALL OVER.
CONTACT AREA 0.0002mm MIN Au PLATE.
SOLDERING AREA 0.00005mm MIN Au PLATE.
SOLDER PEG : 0.001mm MIN Sn PL OVER
0.0013mm MIN Ni PL ALL OVER.

△ FINISH:
SIGNAL & GROUND CONTACT :
UNDER PLATE Ni 0.0013mm MIN ALL OVER.
CONTACT AREA 0.00076mm MIN Au PLATE.
SOLDERING AREA 0.00005mm MIN Au PLATE.
SOLDER PEG : 0.001mm MIN Sn PL OVER
0.0013mm MIN Ni PL ALL OVER.

△ THIS POSITION IS GROUND CIRCUIT.

THIS DRAWING IS A CONTROLLED DOCUMENT.

DIMENSIONS:	TOLERANCES UNLESS OTHERWISE SPECIFIED:
MM	

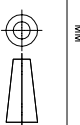

DIM	CHK	APVD	DATE

MATERIAL	FINISH	WEIGHT

STE TE Connectivity Ltd.

HARD TRAY ASSY
FH 0.5 BTB CONNECTOR 440POS
PLUG 5H W/G-PLATE ON 2 ROW CAP

SIZE: A3
CAGE CODE: 00779
DRAWING NO: 1827233

SCALE	SHEET	REV
4:1	3 of 4	C4

