

## 1 Features

- Input Voltage up to 30 V
- Output Voltage Tolerances of  $\pm 5\%$  Over the Temperature Range
- Available Output Voltages: 5 V, 6.2 V, 8.2 V, 9 V, 12 V, and 15 V
- Output Current of 100 mA
- Output Transistor Safe Area Protection
- Internal Thermal Overload Protection
- Internal Short-Circuit Current Limit
- No External Components
- Available in Tiny DSBGA Package
- Available in 3-Pin TO-92 and 8-Pin SOIC Low Profile Packages

## 2 Applications

- Battery Chargers
- Portable Instrumentation
- LED Lighting
- Low Wattage Power Supplies

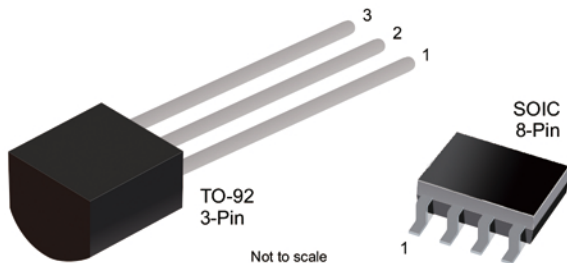

## 3 Description

The XL78L05A series of three terminal positive regulators is available with several fixed output voltages, making them useful in a wide range of applications. Used as a Zener-diode and resistor combination replacement, the XL78L05A usually provides an effective output impedance improvement of two orders of magnitude and lower quiescent current. These regulators can provide local, on-card regulation, eliminating distribution problems associated with single-point regulation. The available voltages allow the XL78L05A to be used in logic systems, instrumentation, HiFi, and other solid-state electronic equipment.

The XL78L05A is available in the plastic TO-92 (LP) package, the SOIC (D) package, and a chip-sized package (8-Bump DSBGA) using TI's DSBGA package technology. With adequate heat sinking, the regulator can deliver 100-mA output current. Current limiting is included to limit the peak output current to a safe value. Safe area protection for the output transistors is provided to limit internal power dissipation. If internal power dissipation is too high for the heat sinking provided, the thermal shutdown circuit prevents the IC from overheating.

## 4 Fixed Output Regulator Circuit

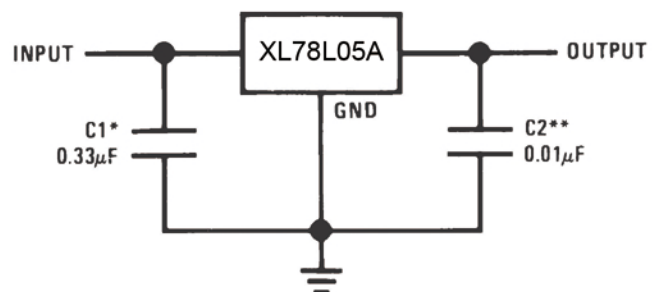

5 Pin Configuration and Functions

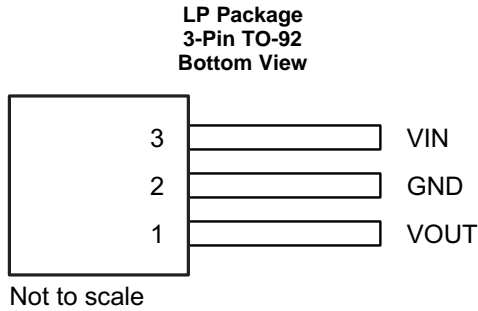
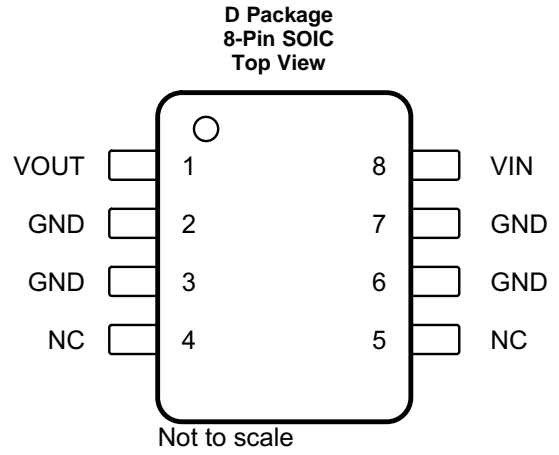
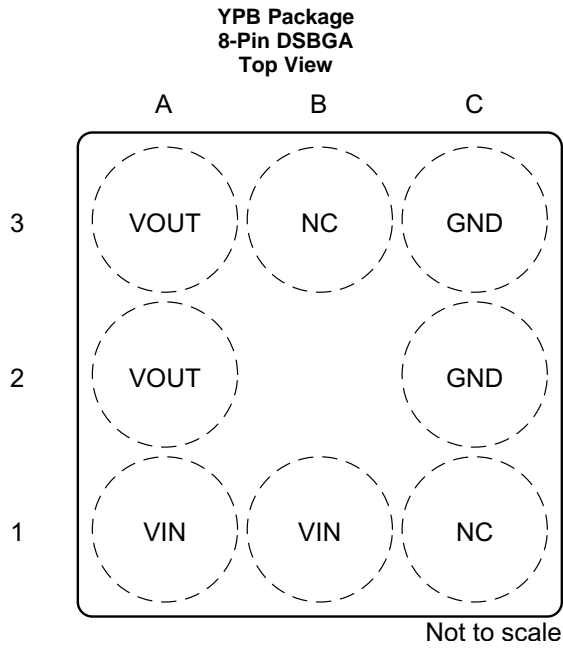

**Pin Functions**

PIN				I/O	DESCRIPTION
NAME	DSBGA	SOIC	TO-92		
GND	C2, C3	2, 3, 6, 7	2	—	Ground
NC	B3, C1	4, 5	—	—	No connection
VIN	A1, B1	8	3	I	Input supply voltage pin
VOUT	A2, A3	1	1	O	Output voltage pin

# XL78L05A SOP8 / XT78L05 TO92

## 6 Specifications

### 6.1 Absolute Maximum Ratings

over operating free-air temperature range (unless otherwise noted)<sup>(1)(2)</sup>

		MIN	MAX	UNIT
Input voltage		35		V
Power dissipation		Internally limited		
Operating junction temperature, $T_J$	XT78L05 (TO-92)	0	125	°C
	XL78L05A (SOP8)	-40	85	
Storage temperature, $T_{stg}$		-65	150	°C

(1) Stresses beyond those listed under *Absolute Maximum Ratings* may cause permanent damage to the device. These are stress ratings only, which do not imply functional operation of the device at these or any other conditions beyond those indicated under *Recommended Operating Conditions*. Exposure to absolute-maximum-rated conditions for extended periods may affect device reliability.

### 6.2 ESD Ratings

		VALUE	UNIT
$V_{(ESD)}$	Electrostatic discharge Human-body model (HBM), <sup>(1)</sup>	±1000	V

(1) Human body model, 1.5 k $\Omega$  in series with 100 pF.

### 6.3 Recommended Operating Conditions

over operating free-air temperature range (unless otherwise noted)

		MIN	NOM	MAX	UNIT
Input voltage		30			V
Continuous output current		100			mA
$T_J$ Junction temperature	XT78L05 (TO-92)	0		125	°C
	XL78L05A (SOP8)	-40		85	

### 6.4 Thermal Information

THERMAL METRIC <sup>(1)</sup>		XL78L05A/XT78L05		UNIT
		SOP	TO-92	
		8 PINS	3 PINS	
$R_{\theta JA}$	Junction-to-ambient thermal resistance	128.8	158.7	°C/W
$R_{\theta JC(top)}$	Junction-to-case (top) thermal resistance	76	75.2	°C/W
$R_{\theta JB}$	Junction-to-board thermal resistance	69.3	n/a	°C/W
$\Psi_{JT}$	Junction-to-top characterization parameter	26.3	30.2	°C/W
$\Psi_{JB}$	Junction-to-board characterization parameter	68.8	138.2	°C/W
$R_{\theta JC(bot)}$	Junction-to-case (bottom) thermal resistance	—	—	°C/W

(1) For more information about traditional and new thermal metrics, see the *Semiconductor and IC Package Thermal Metrics* application report.

# XL78L05A SOP8 / XT78L05 TO92

## 6.5 Electrical Characteristics —XL78L05A

Typical values apply for  $T_J = 25^\circ\text{C}$ , Minimum and Maximum limits apply for the entire operating temperature range of the package<sup>(1)(2)</sup>,  $I_O = 40\text{ mA}$ ,  $C_I = 0.33\ \mu\text{F}$ ,  $C_O = 0.1\ \mu\text{F}$ ,  $V_{IN} = 10\text{ V}$  (unless otherwise noted).

PARAMETER		TEST CONDITIONS	MIN	TYP	MAX	UNIT
$V_O$	Output voltage	$T_J = 25^\circ\text{C}$	4.8	5	5.2	V
		$V_{IN} = 7\text{ V to }20\text{ V}$ , $I_O = 1\text{ mA to }40\text{ mA}$ <sup>(3)</sup>	4.75		5.25	
		$I_O = 1\text{ mA to }70\text{ mA}$ <sup>(3)</sup>	4.75		5.25	
$\Delta V_O$	Line regulation	$V_{IN} = 7\text{ V to }20\text{ V}$ , $T_J = 25^\circ\text{C}$		18	75	mV
		$V_{IN} = 8\text{ V to }20\text{ V}$ , $T_J = 25^\circ\text{C}$		10	54	
	Load regulation	$I_O = 1\text{ mA to }100\text{ mA}$ , $T_J = 25^\circ\text{C}$		20	60	
		$I_O = 1\text{ mA to }40\text{ mA}$ , $T_J = 25^\circ\text{C}$		5	30	
$I_Q$	Quiescent current	$T_J = 25^\circ\text{C}$		3	5	mA
$\Delta I_Q$	Quiescent current change	$V_{IN} = 8\text{ V to }20\text{ V}$			1	mA
		$I_O = 1\text{ mA to }40\text{ mA}$			0.1	
$V_n$	Output noise voltage	$f = 10\text{ Hz to }100\text{ kHz}$ <sup>(4)</sup>		40		$\mu\text{V}$
$\Delta V_{IN}/\Delta V_O$	Ripple rejection	$f = 120\text{ Hz}$ , $V_{IN} = 8\text{ V to }16\text{ V}$ , $T_J = 25^\circ\text{C}$	47	62		dB
$I_{PK}$	Peak output current			140		mA
$\Delta V_O/\Delta T$	Average output voltage temperature coefficient	$I_O = 5\text{ mA}$		-0.65		mV/ $^\circ\text{C}$
$V_{IN(MIN)}$	Minimum value of input voltage required to maintain line regulation	$T_J = 25^\circ\text{C}$		6.7	7	V

- (1) For the operating ranges of each package, see *Absolute Maximum Ratings*.
- (2) Limits are ensured by production testing or correlation techniques using standard Statistical Quality Control (SQC) methods.
- (3) Power dissipation  $\leq 0.75\text{ W}$ .
- (4) Recommended minimum load capacitance of  $0.01\ \mu\text{F}$  to limit high-frequency noise.

6.10 Typical Characteristics

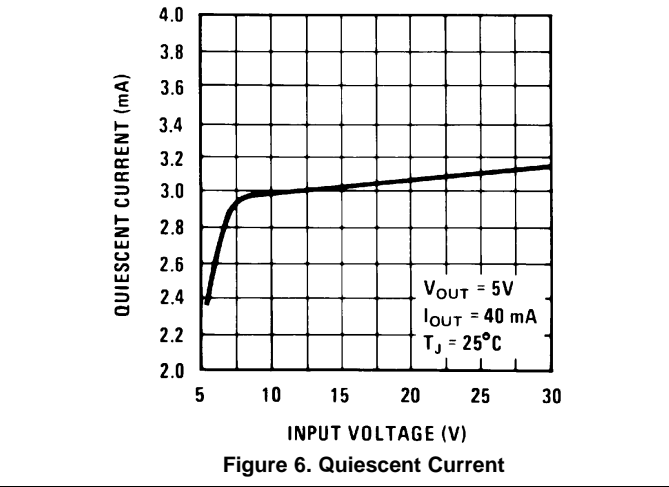
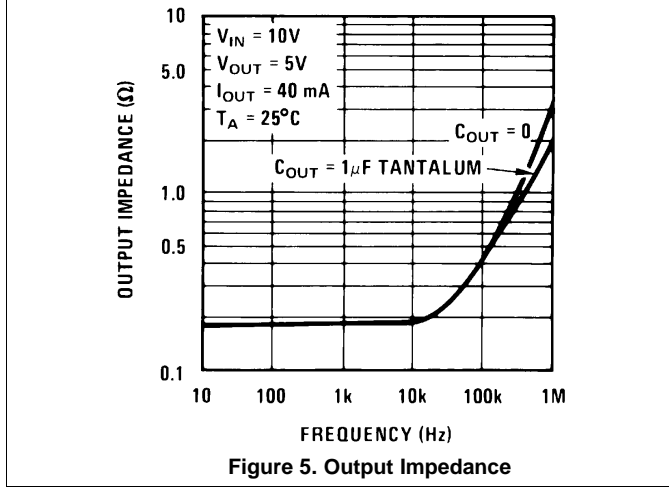
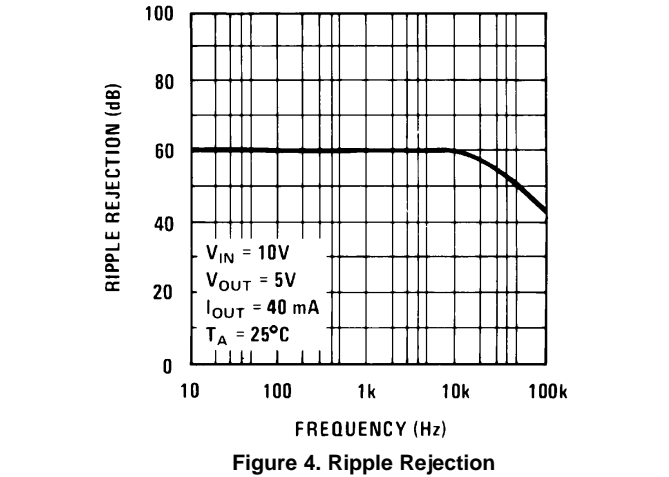
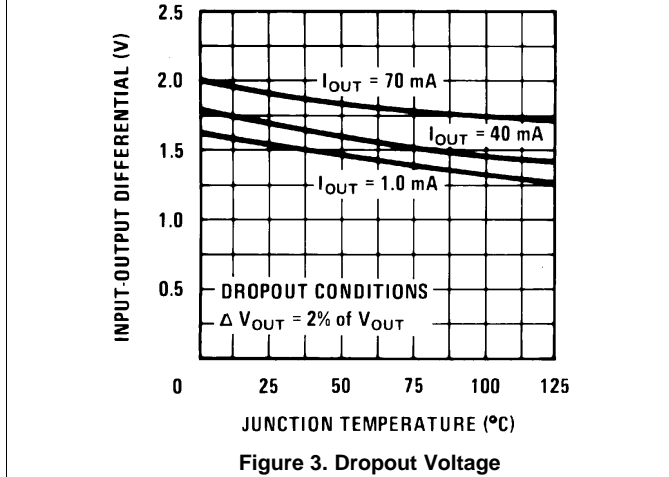
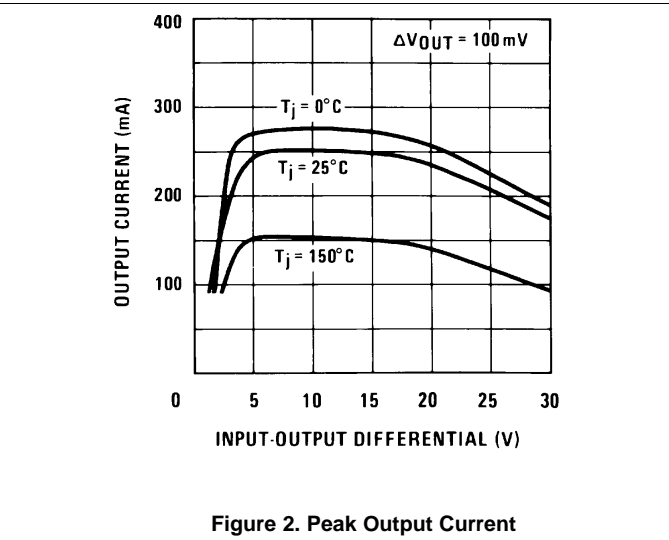
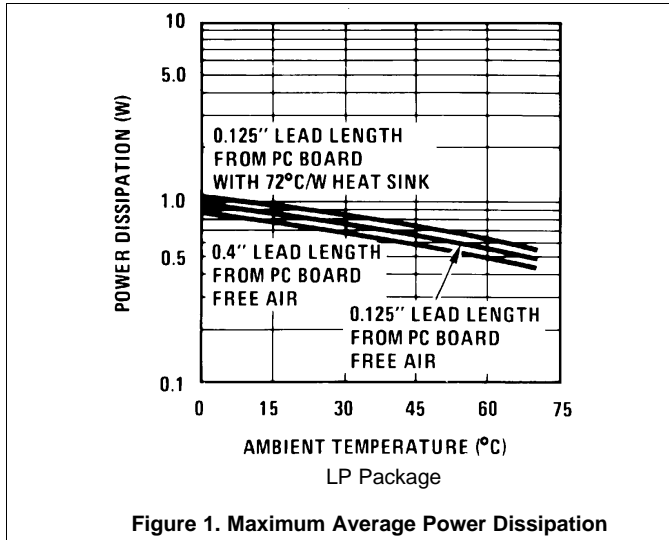

Typical Characteristics (continued)

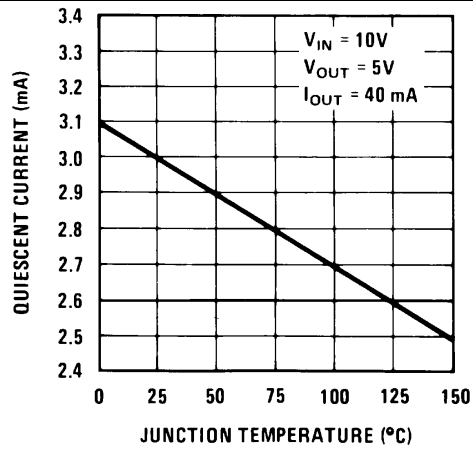

Figure 7. Quiescent Current

## 7 Detailed Description

### 7.1 Overview

The XL78L05A series of positive regulators is available in the following fixed output voltages: 5V, 6.2V, 8.2V, 9V, 12V, and 15V. The regulator can be configured to an adjustable output by connecting the GND pin to the center of a resistive voltage divider as shown in Figure 10. In this configuration, the fixed output voltage acts as the reference voltage across R1 allowing the output to be adjusted by changing the resistor.

### 7.2 Functional Block Diagram

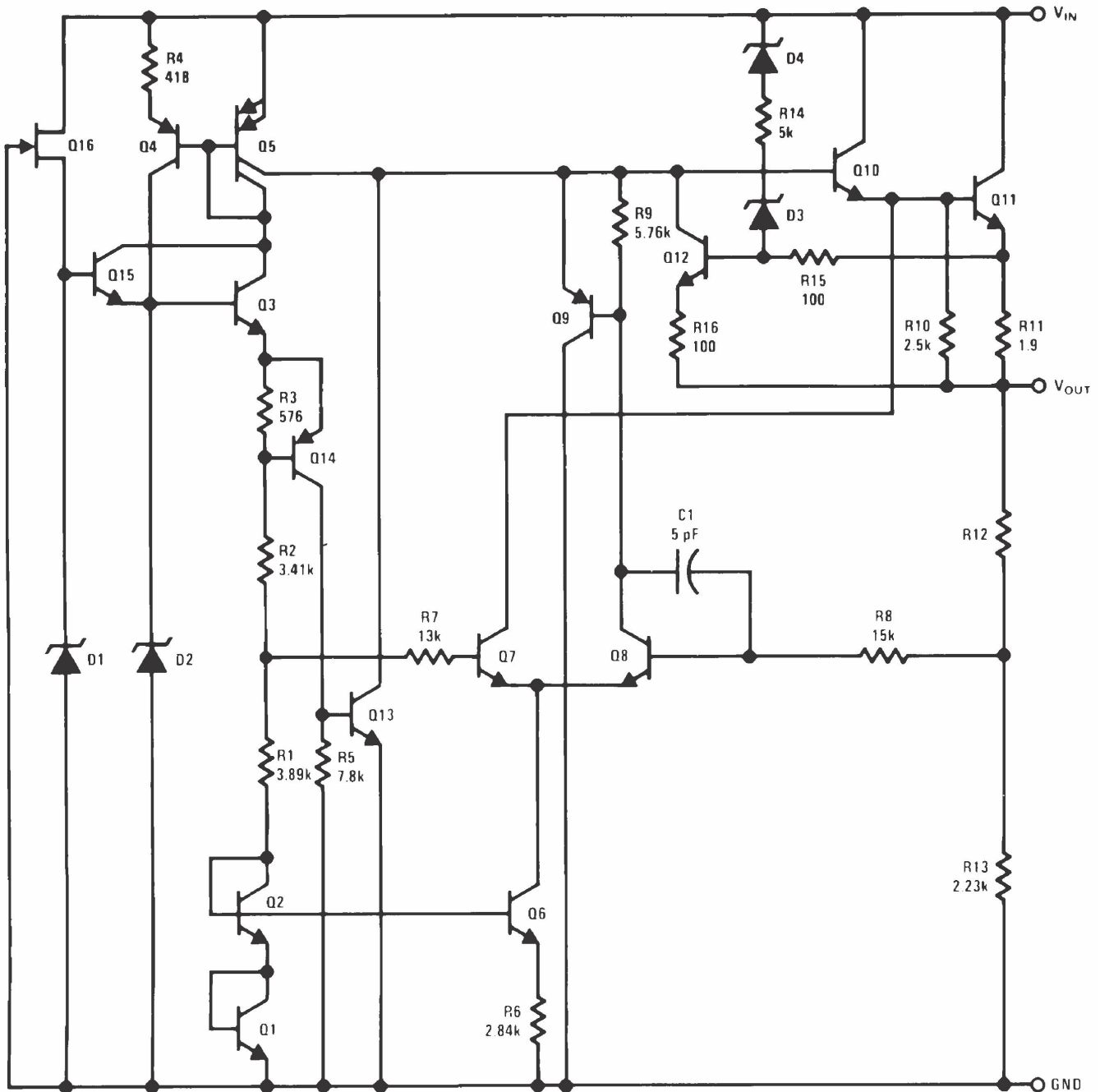

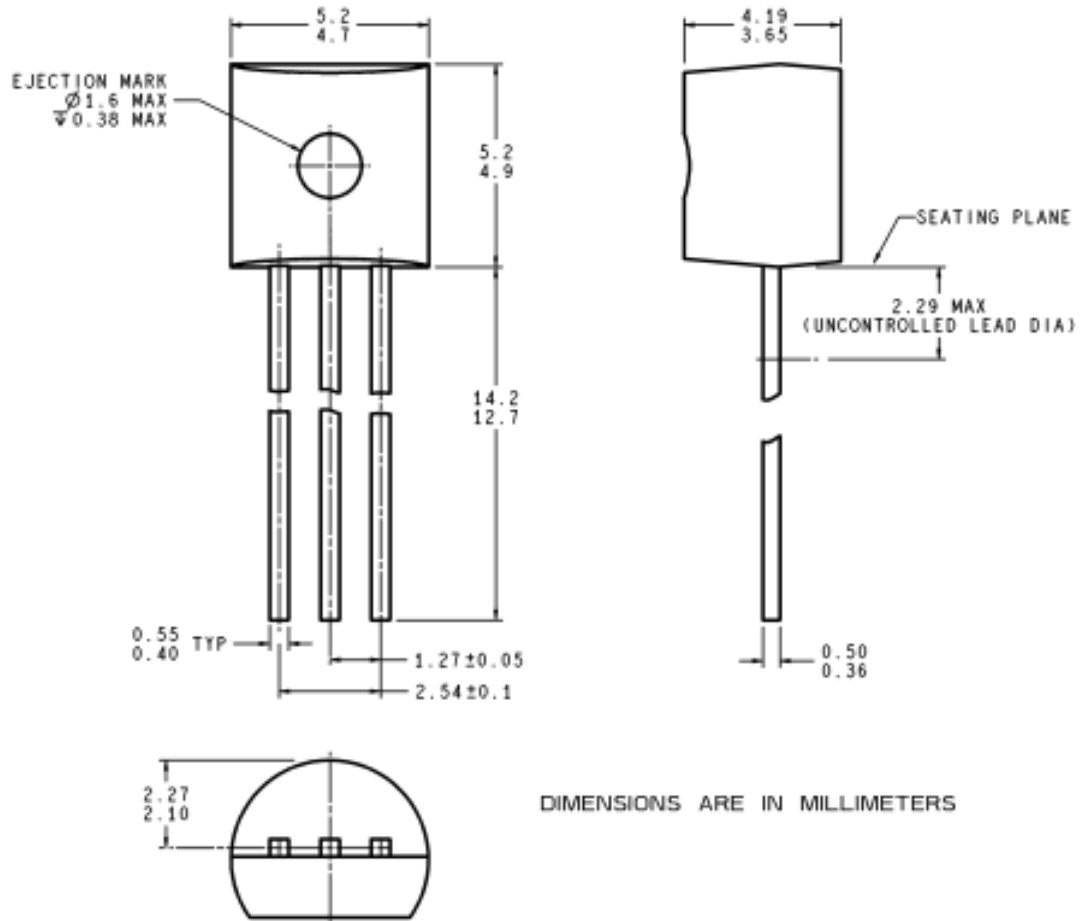



# XL78L05A SOP8 / XT78L05 TO92

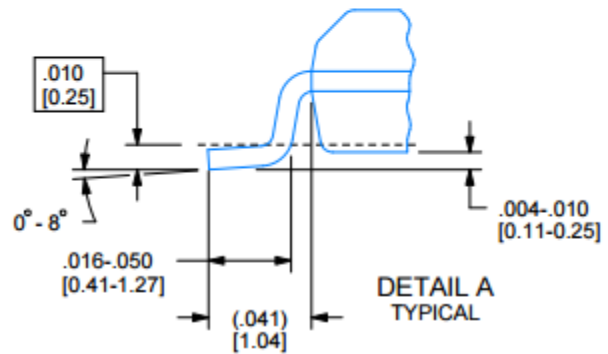
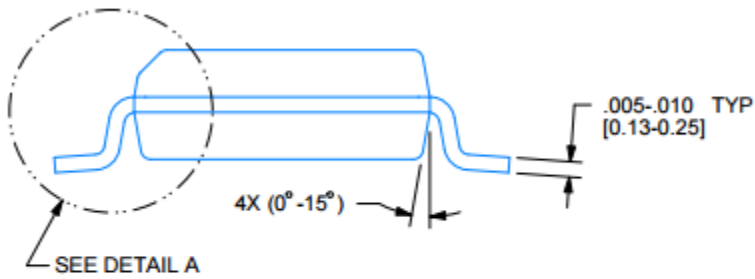
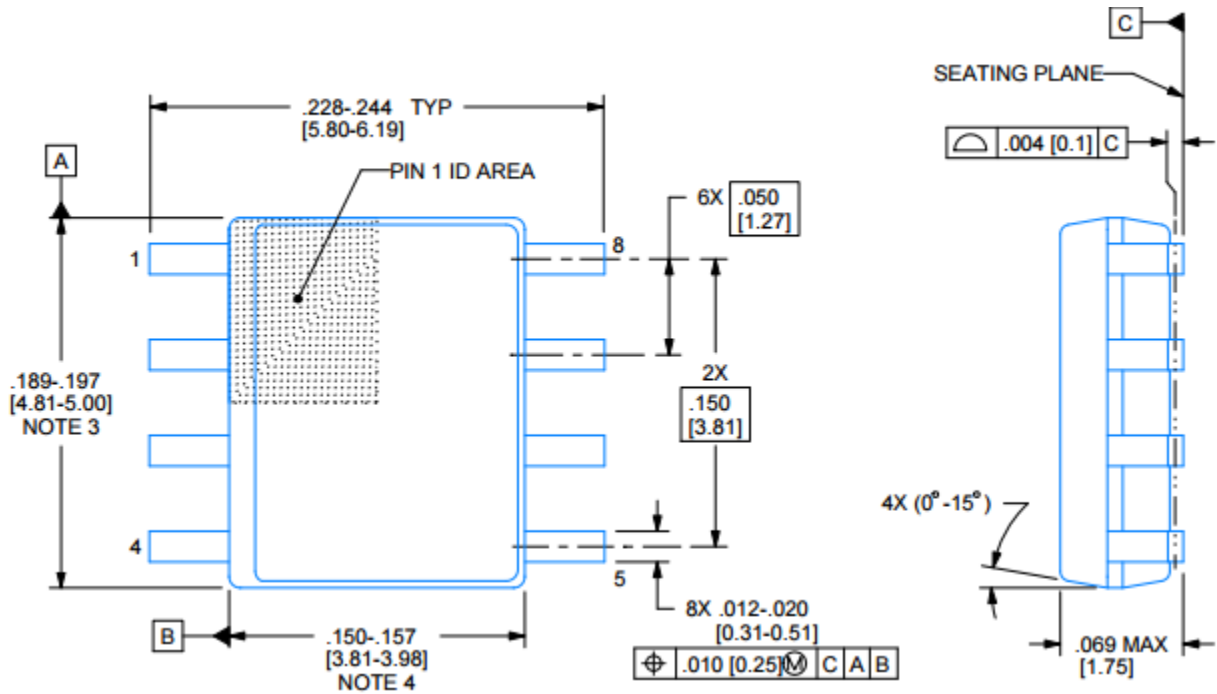

# XL78L05A SOP8 / XT78L05 TO92

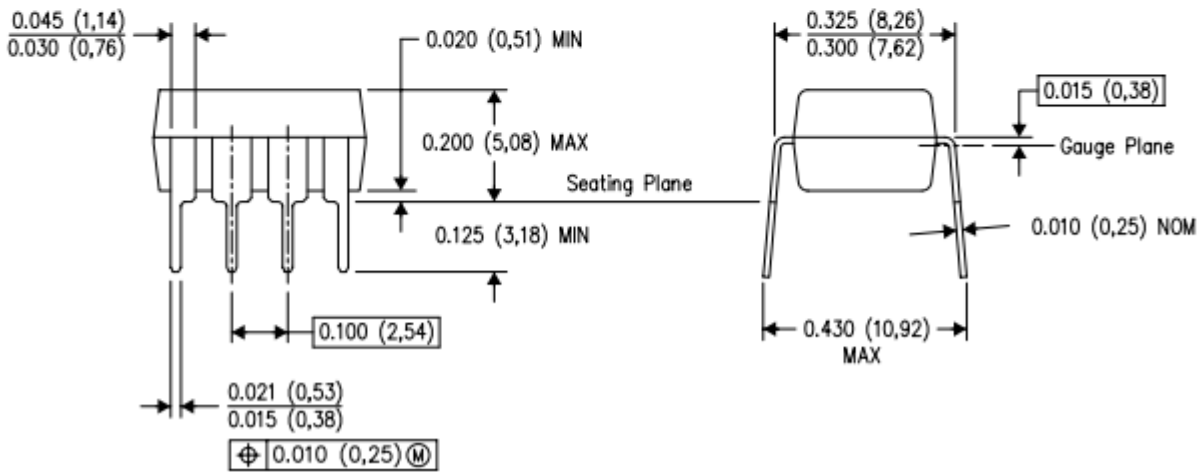
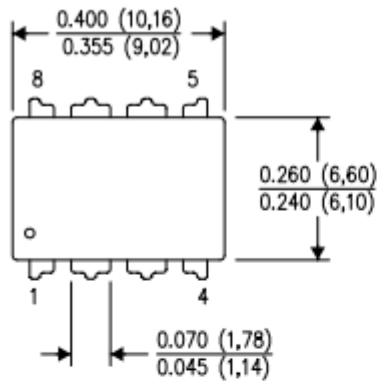

以上信息仅供参考. 如需帮助联系客服人员。谢谢 XINLUDA