

Description

The LM2575/6 series switching regulators are monolithic integrated circuits designed for use in “buck” or “buck/boost” regulator applications requiring accurate output voltages over combined variations of line, load and temperature. This unique series greatly simplifies switching power supply design. The LM2575 has a maximum output current of 1A and the LM2576 is rated for 3A.

The LM2575/6 series miniconverters include a switching regulator and compensation network all within the same package. Just add a choke, catch diode and two capacitors to obtain an efficient DC-to-DC converter. The current limit and thermal shutdown features of the LM2575/6 series fully protect the device against overstress conditions.

The LM2575/6 series offers an alternative to popular 3 terminal linear regulators by providing higher efficiency with reduced heatsink size. In many applications a heat sink will not be required.

Features

- ◆ Pin for pin replacement for National’s LM2575/6 series
- ◆ DC-to-DC buck or buck/boost converter requiring only 4 support components
- ◆ Fixed or adjustable voltages
- ◆ Preset output voltages of 3.3V, 5V and 12V
- ◆ Wide output voltage range, 1.23V to 35V
- ◆ 82% typical efficiency @ 5V out
- ◆ Wide input voltage range, 4V to 40V
- ◆ Inhibit/enable control pin
- ◆ Industrial temperature range
- ◆ TO-220 and TO-263 packages

Applications

- ◆ Micro controller power supplies
- ◆ Medical equipment
- ◆ Industrial power supplies
- ◆ Instrumentation power supplies

Typical Application Circuits

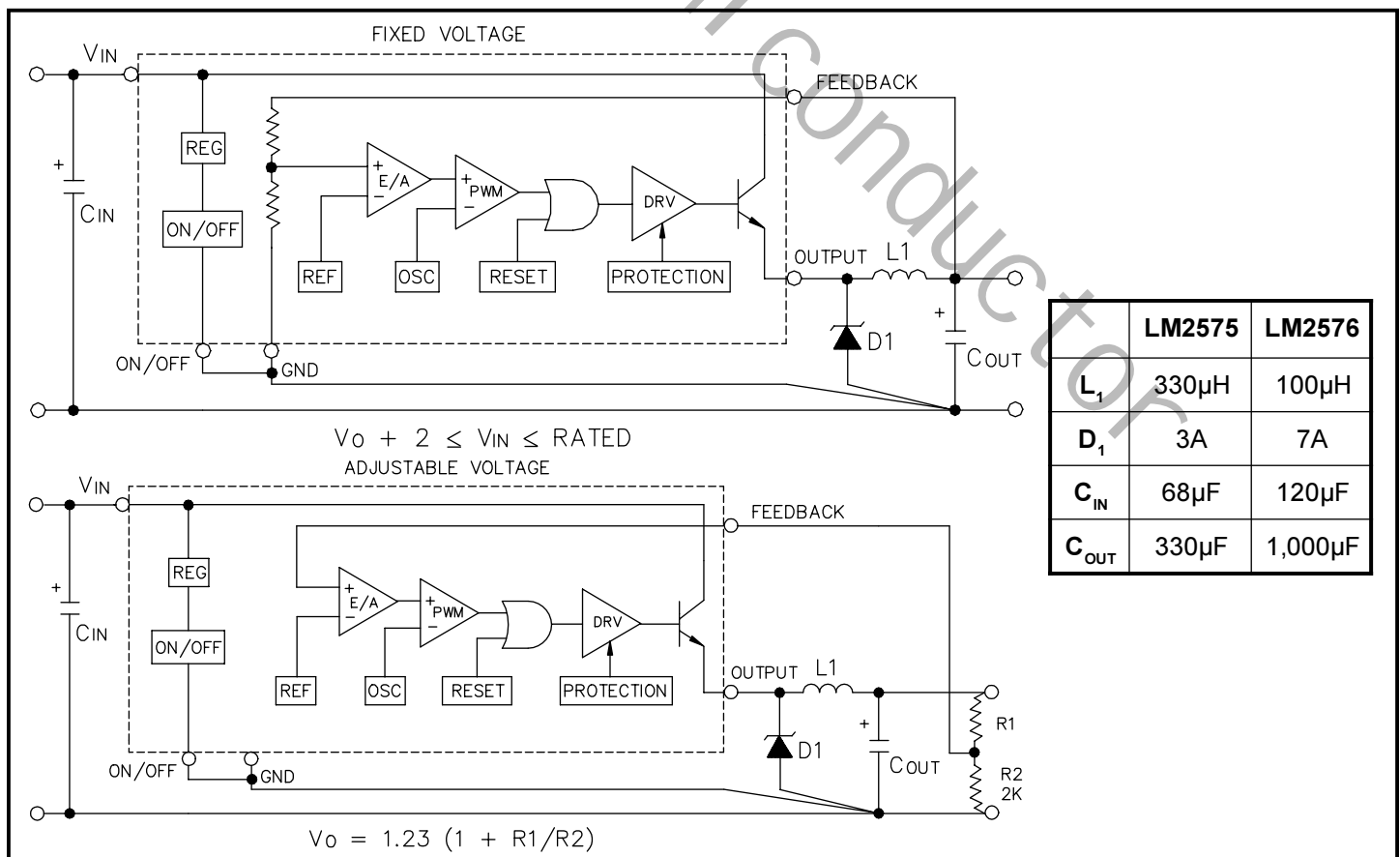

Absolute Maximum Ratings

Parameter	Symbol	Maximum	Units
Input Voltage	V_{IN}	45	V
On/Off Pin Input Voltage	$V_{ON/OFF}$	$-0.3 \leq V_{ON/OFF} \leq V_{IN}$	V
Output Voltage to Common (Steady State)		-1	V
Power Dissipation	P_D	Internally Limited	W
Thermal Resistance Junction to Ambient TO-220 TO-263	θ_{JA}	55 60	$^{\circ}\text{C/W}$
Thermal Resistance Junction to Case TO-220 TO-263	θ_{JC}	2.0 2.0	$^{\circ}\text{C/W}$
Operating Junction Temperature Range	T_J	-40 to +125	$^{\circ}\text{C}$
Storage Temperature Range	T_{STG}	-65 to +150	$^{\circ}\text{C}$
Lead Temperature (Soldering) 10 Sec.	T_{LEAD}	300	$^{\circ}\text{C}$
ESD Rating (Human Body Model)	V_{ESD}	2	kV

Electrical Characteristics

Unless otherwise specified: $V_{IN} = 12\text{V}$ for 3.3V, 5V and ADJ options and 25V for 12V option; $V_{OUT} = 5\text{V}$ for ADJ option; $T_A = 25^{\circ}\text{C}$; V_{IN} rated = 40V; $I_O = 0.5$ to 3A (LM2576), 0.2 to 1A (LM2575). Values in **bold** apply over full operating temperature range.

Parameter	Symbol	Test Conditions	Min	Typ	Max	Units
Output Voltage	V_O	$I_O = 0.5\text{A}$	3.23	3.30	3.37	V
LM2576S-3.3		8V to V_{IN} Rated	3.20		3.40	
			3.14		3.47	
Output Voltage	V_O	$I_O = 0.5\text{A}$	4.90	5.00	5.10	V
LM2576S-5.0		8V to V_{IN} Rated	4.85		5.15	
			4.75		5.25	
Output Voltage	V_O	$I_O = 0.5\text{A}$	11.76	12.00	12.24	V
LM2576-12		15V to V_{IN} Rated	11.52		12.48	
			11.40		12.60	
Feedback Voltage	V_{FB}	$I_O = 0.5\text{A}$	1.217	1.230	1.243	V
LM2576S-ADJ, $V_O = 5\text{V}$		8V to V_{IN} Rated	1.193		1.267	
			1.180		1.280	
Feedback Bias Current	I_B	$V_{IN} = 12\text{V}, I_O = 0.5\text{A}$		50	100	nA
LM2576S-ADJ					500	

Electrical Characteristics (Cont.)

Unless otherwise specified: $V_{IN} = 12V$ for 3.3V, 5V and ADJ options and 25V for 12V option; $V_{OUT} = 5V$ for ADJ option; $T_A = 25^\circ C$; V_{IN} rated = 40V; $I_o = 0.5$ to 3A (LM2576), 0.2 to 1A (LM2575). Values in **bold** apply over full operating temperature range.

Parameter	Symbol	Test Conditions	Min	Typ	Max	Units
Output Voltage LM2575S-3.3	V_o	$I_o = 0.2A$	3.23	3.30	3.37	V
		8V to V_{IN} Rated	3.20		3.40	
			3.14		3.47	
Output Voltage LM2575S-5.0	V_o	$I_o = 0.2A$	4.90	5.00	5.10	V
		8V to V_{IN} Rated	4.85		5.15	
			4.75		5.25	
Output Voltage LM2575-12	V_o	$I_o = 0.2A$	11.76	12.00	12.24	V
		15V to V_{IN} Rated	11.52		12.48	
			11.40		12.60	
Feedback Voltage LM2575S-ADJ, $V_o = 5V$	V_{FB}	$I_o = 0.2A$	1.217	1.230	1.243	V
		8V to V_{IN} Rated	1.193		1.267	
			1.180		1.280	
Feedback Bias Current LM2575S-ADJ	I_B	$V_{IN} = 12V, I_o = 0.2A$		50	100	nA
Efficiency/Option 3.3V 5V 12V ADJ, $V_o = 5V$	η	$V_{IN} = 12V, I_o = 1A$ (LM2575, 3A for LM2576)		77		%
				82		
		$V_{IN} = 15V, I_o = 1A$ (LM2575, 3A for LM2576)		88		
			$V_{IN} = 12V, I_o = 1A$ (LM2575, 3A for LM2576)		82	
Switching Frequency	f_{SX}		47	52	58	kHz
			43		62	
Saturation Voltage ⁽¹⁾	V_{SAT}	LM2575, $I_o = 1A$		0.9	1.2	V
		LM2576, $I_o = 3A$		0.9	1.4	
Max. Duty Cycle (On) ⁽³⁾	DC		93	98		%
Peak Current LM2575 ⁽¹⁾	I_{CL}		1.7	2.2	3.0	A
			1.3		3.2	
Peak Current LM2576 ⁽¹⁾	I_{CL}		4.2	5.8	6.9	A
			3.5		7.5	

Electrical Characteristics (Cont.)

Unless otherwise specified: $V_{IN} = 12V$ for 3.3V, 5V and ADJ options and 25V for 12V option; $V_{OUT} = 5V$ for ADJ option; $T_A = 25^\circ C$; $V_{IN\ rated} = 40V$; $I_O = 0.5$ to 3A (LM2576), 0.2 to 1A (LM2575). Values in **bold** apply over full operating temperature range.

Parameter	Symbol	Test Conditions	Min	Typ	Max	Units
Output Leakage Current ⁽²⁾						
Output = 0V	I_L	$V_{IN} = V_{IN\ Rated}$			2	mA
Output = -1V				7.5	30	
Quiescent Current ⁽²⁾	I_Q			5	10	mA
					12	
Standby Quiescent Current (On/Off Pin = 5V)	I_{STBY}			50		μA
On/Off Pin Logic Input Level	V_{IH}		2.2	1.4		V
			2.4			
	V_{IL}			1.2	1.0	V
					0.8	
On/Off Pin Input Current	I_{IH}	$V_{ON/OFF} = 5V$ (Off)		12	30	μA
	I_{IL}	$V_{ON/OFF} = 0V$ (On)		0	10	

Notes:

- (1) Output sourcing current, resistive load, no inductor or capacitor.
- (2) Feedback = $V_O + 1.0V$.
- (3) Feedback = 0V.

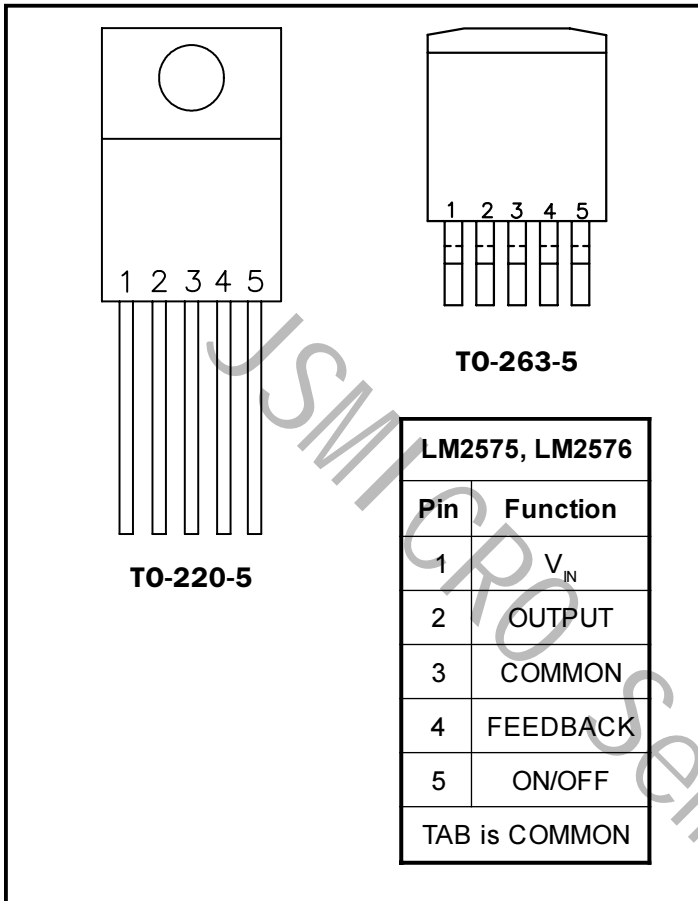
Pin Configurations

Ordering Information

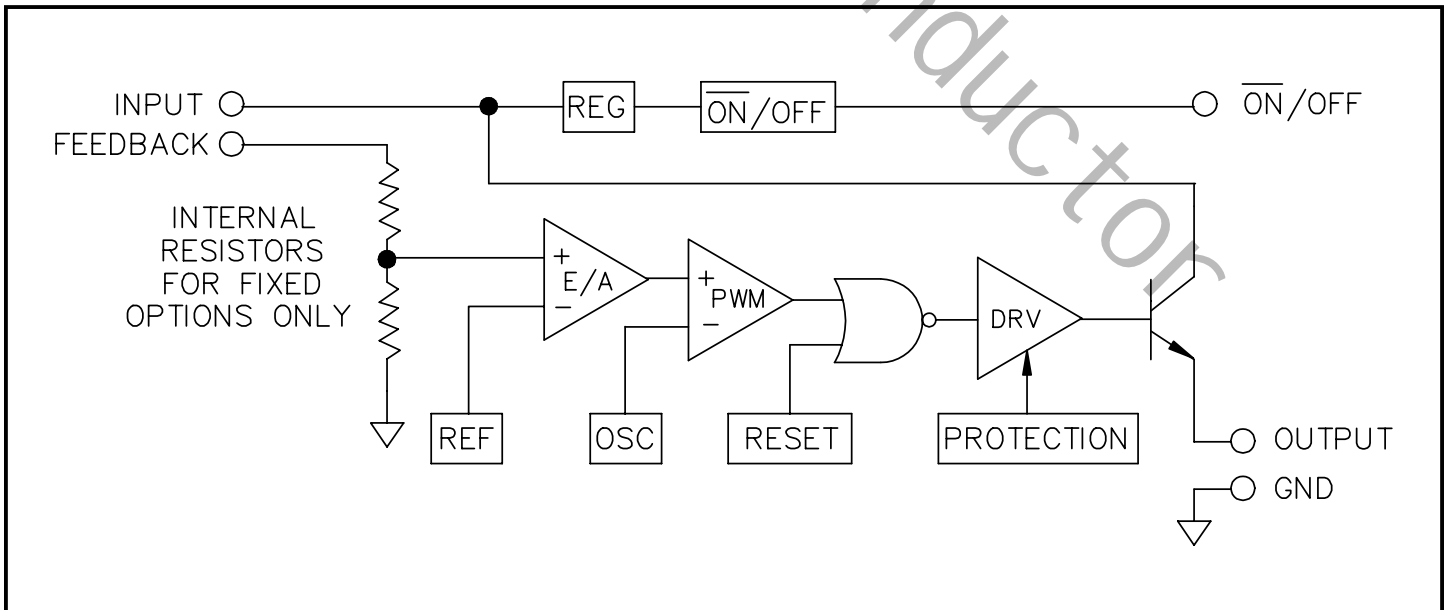
(1) -XX = Voltage Option. Available voltages are 3.3V (-3.3), 5V (-5.0), 12V (-12), and ADJ (-ADJ), which is adjustable between 1.23V and 35V.

Block Diagram

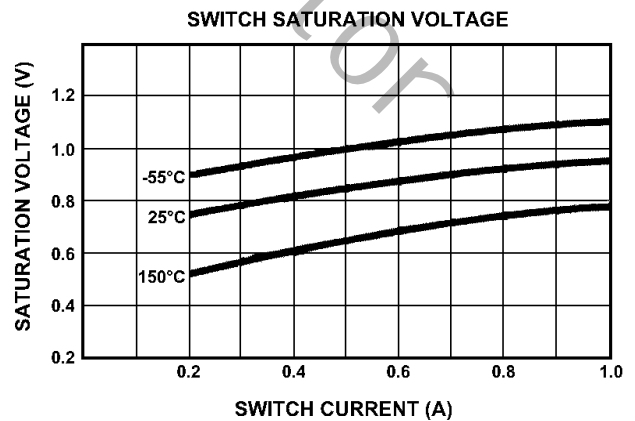
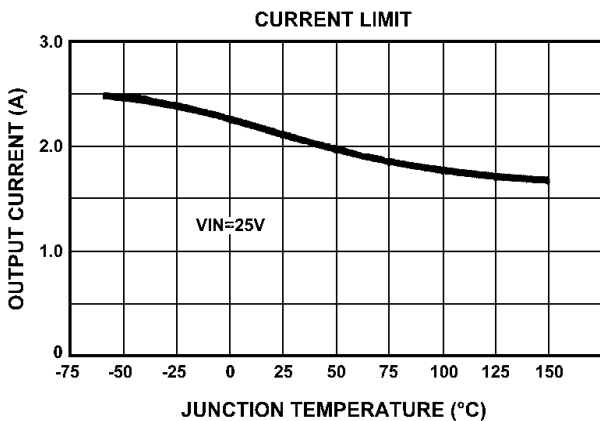
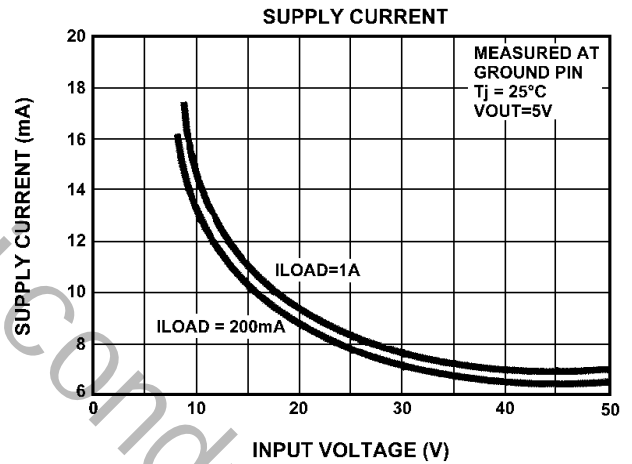
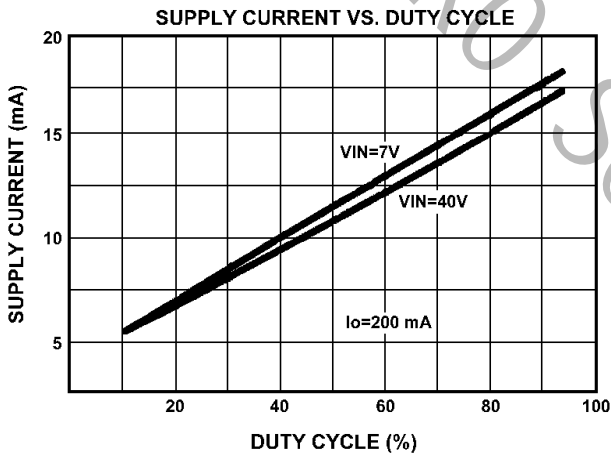
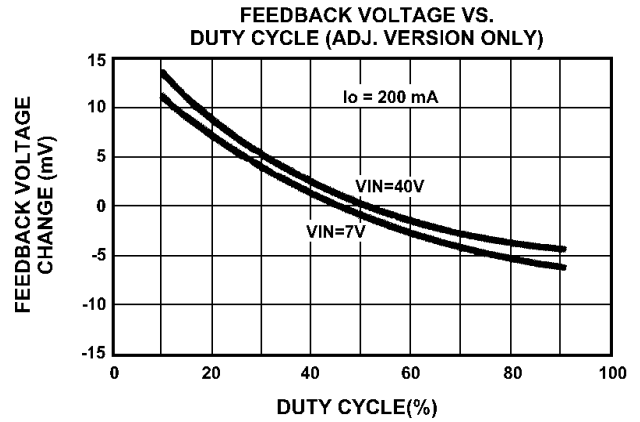
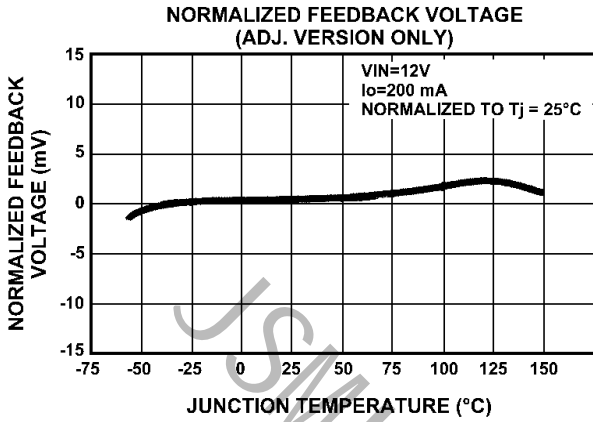
Typical Characteristics - LM2575



Typical Characteristics - LM2575 (Cont.)

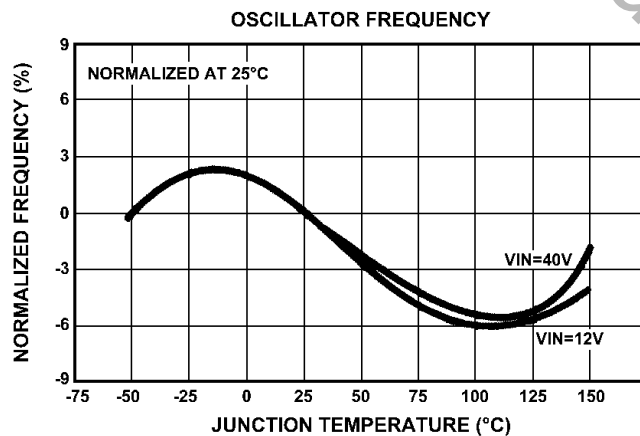
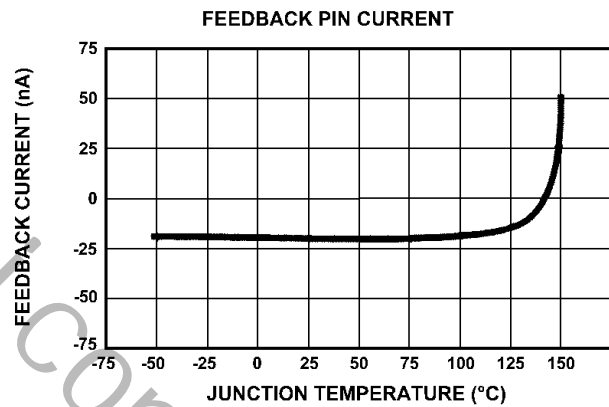
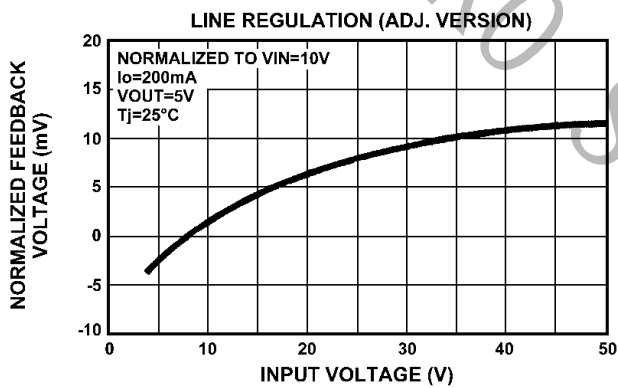
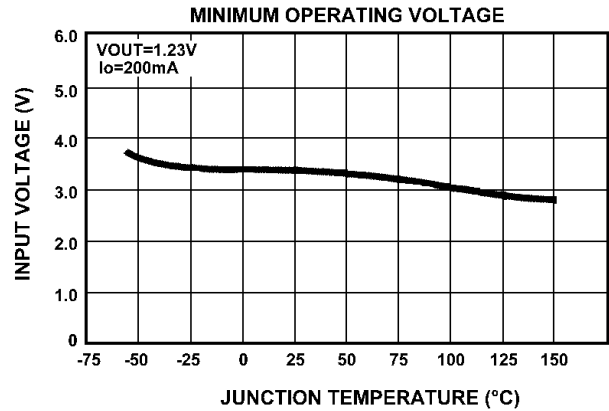
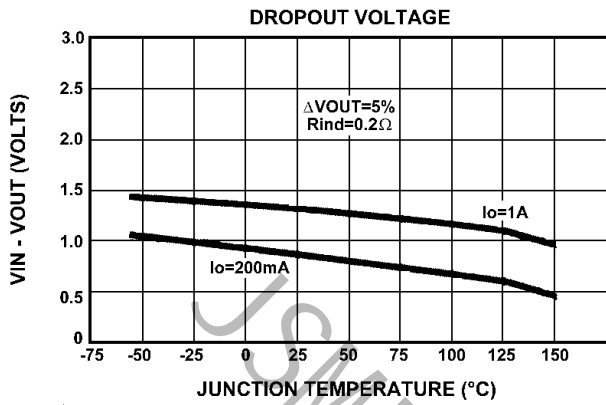

Typical Characteristics - LM2575 (Cont.)

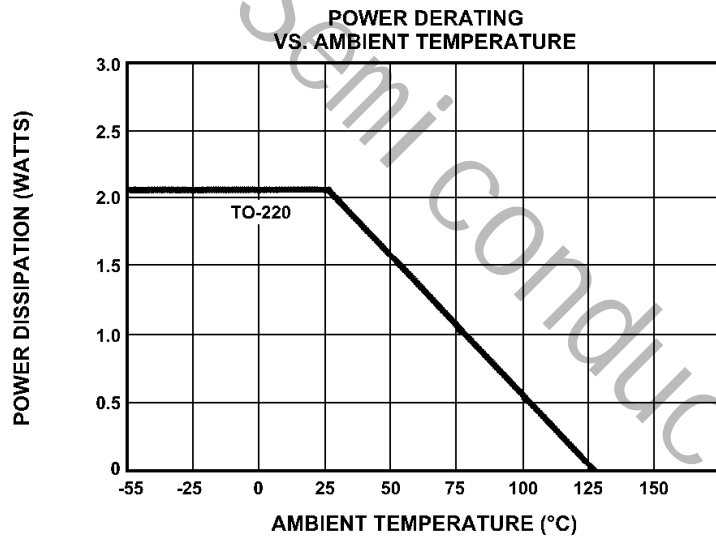
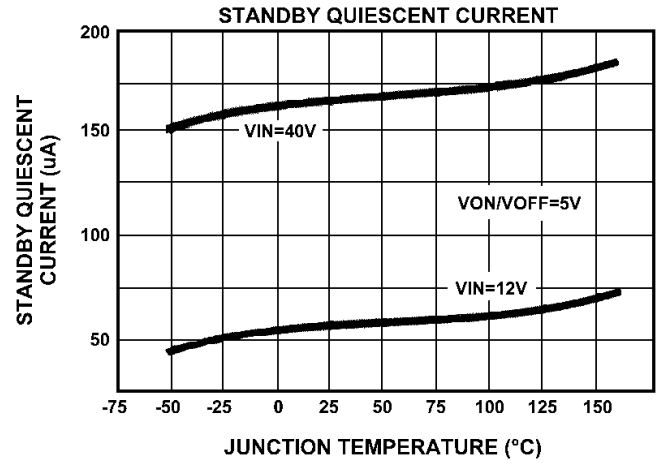
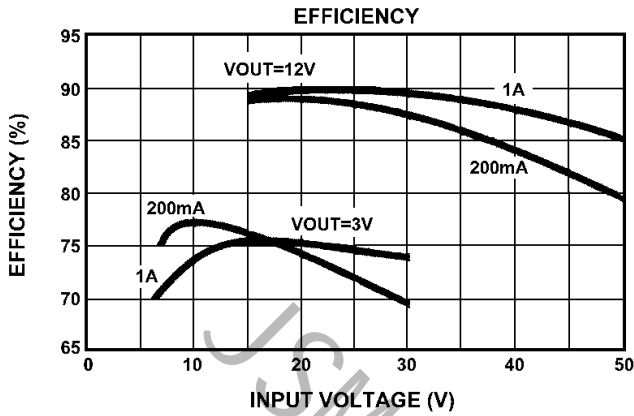

Typical Characteristics - LM2576

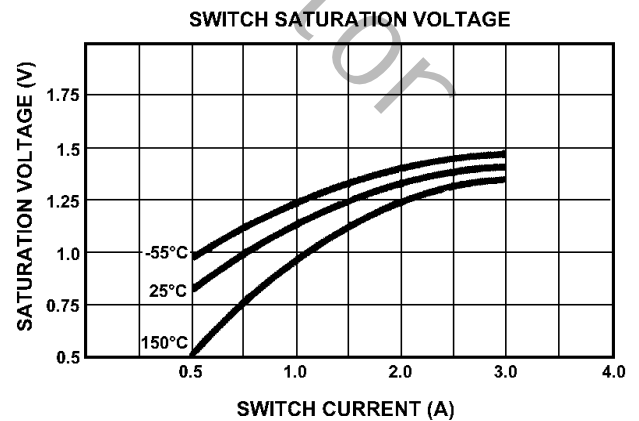
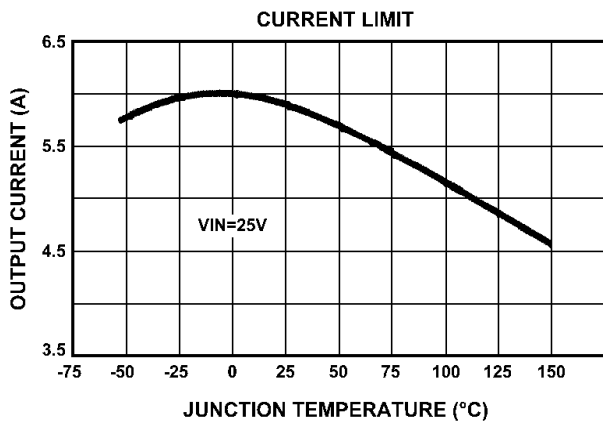
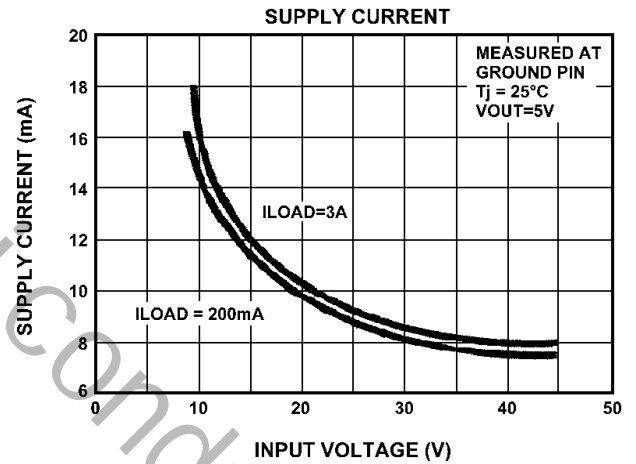
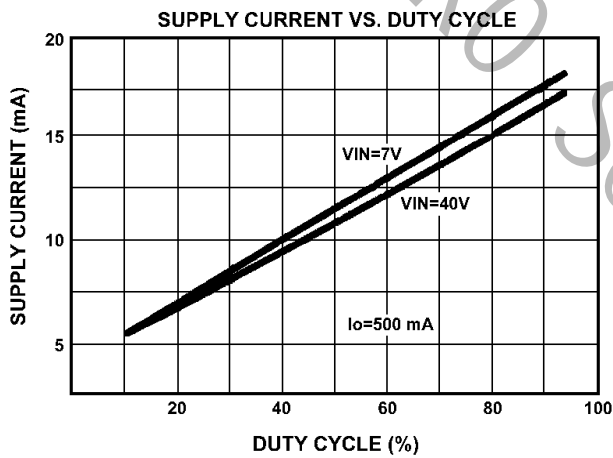
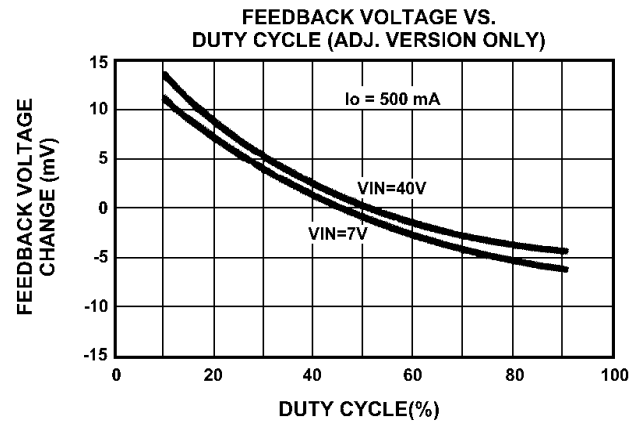
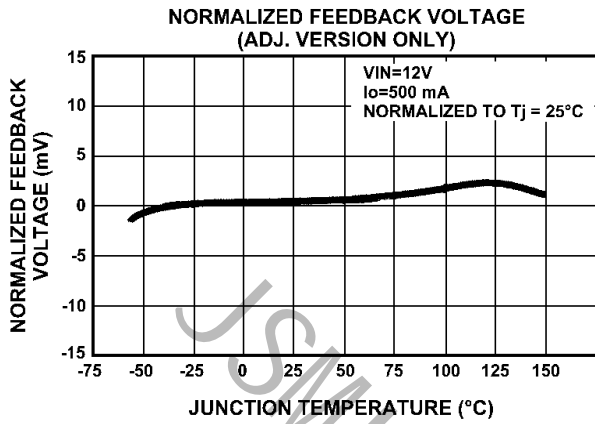

Typical Characteristics - LM2576 (Cont.)

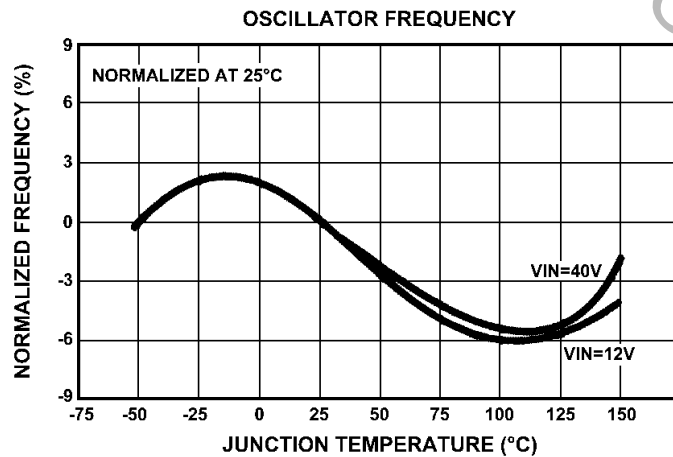
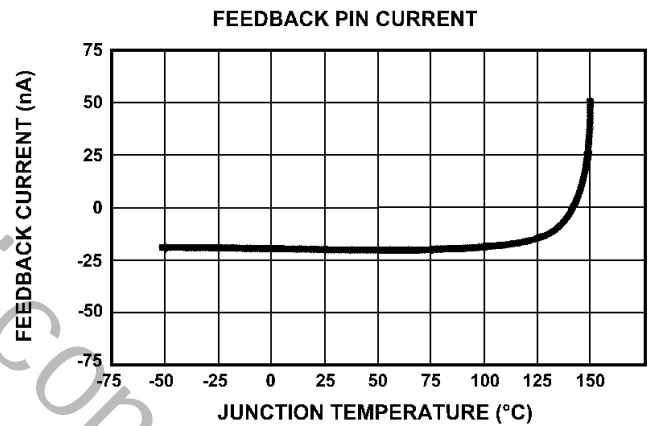
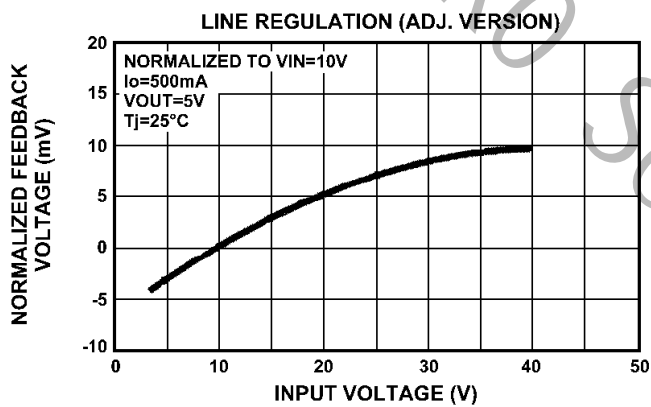
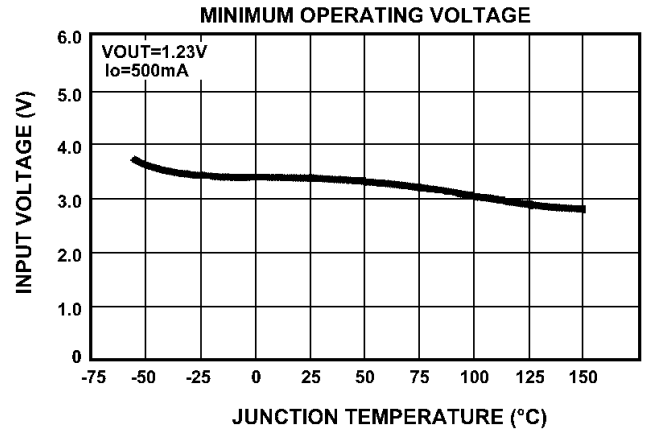
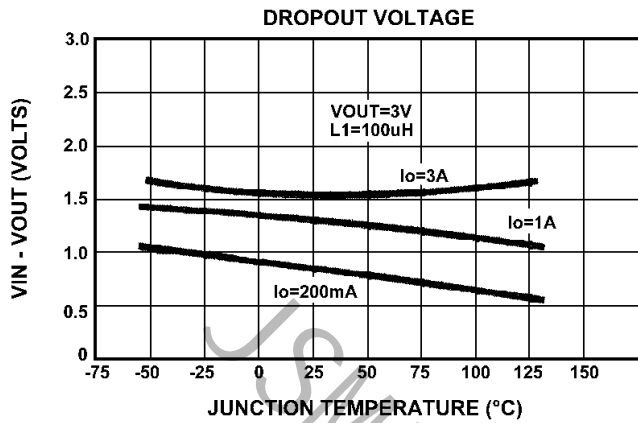

Typical Characteristics - LM2576 (Cont.)

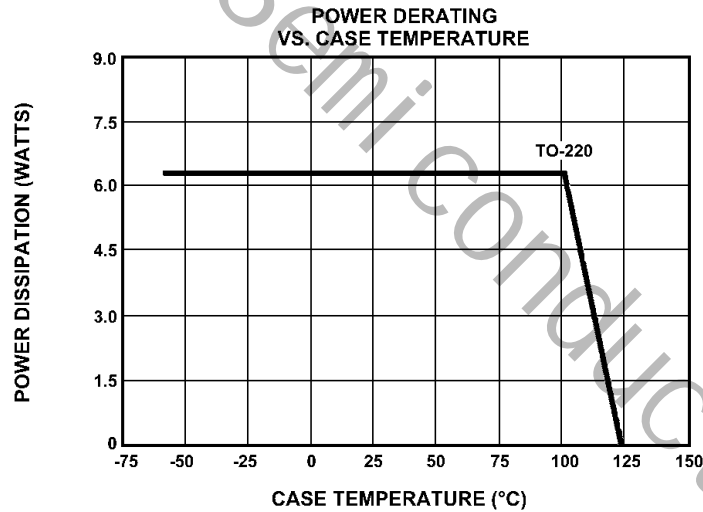
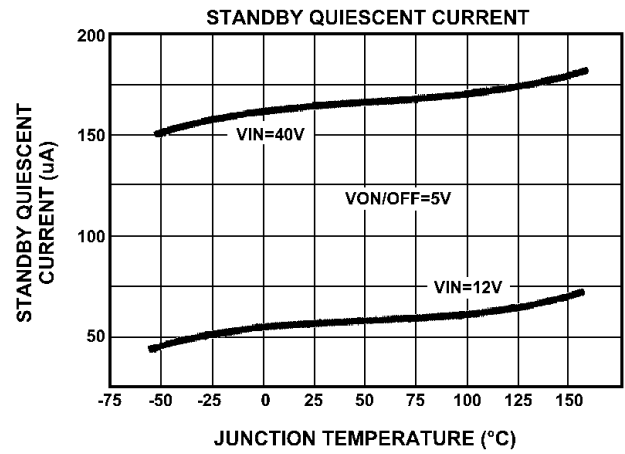
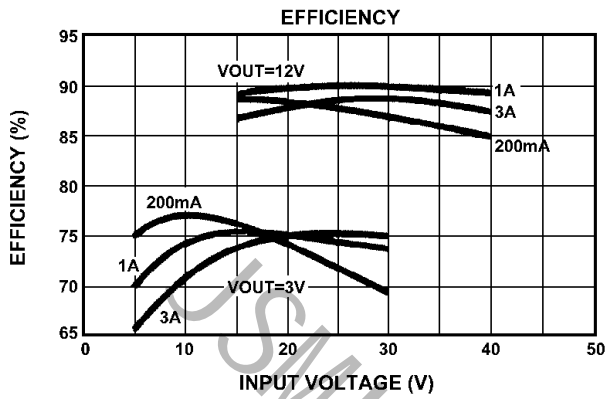

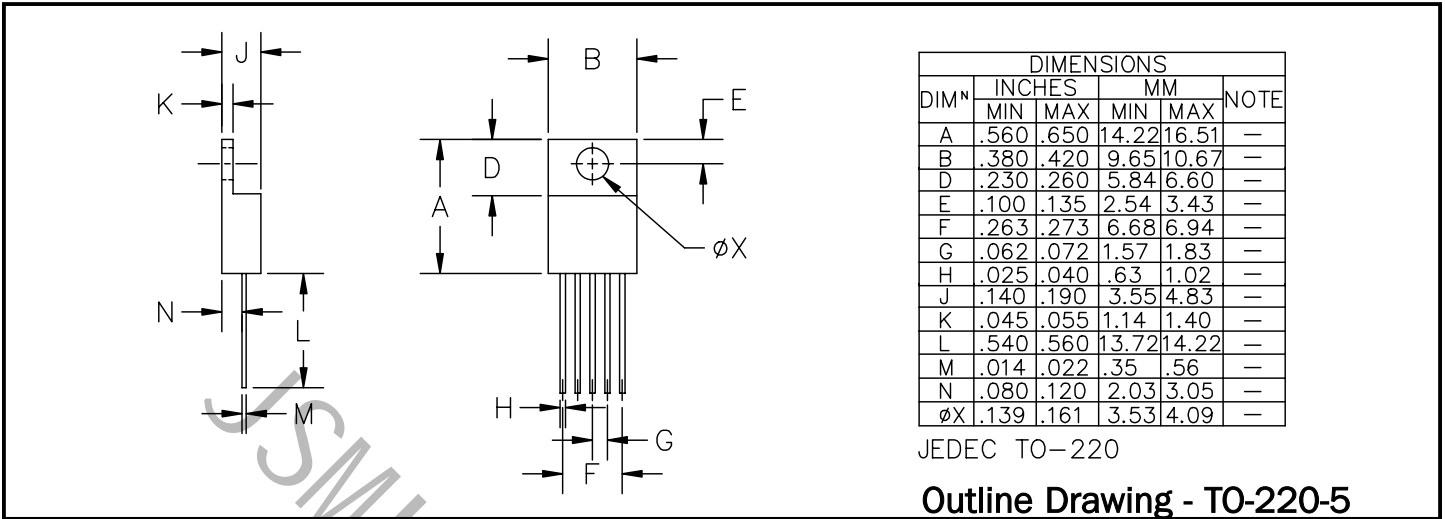

Outline Drawing - TO-263-5

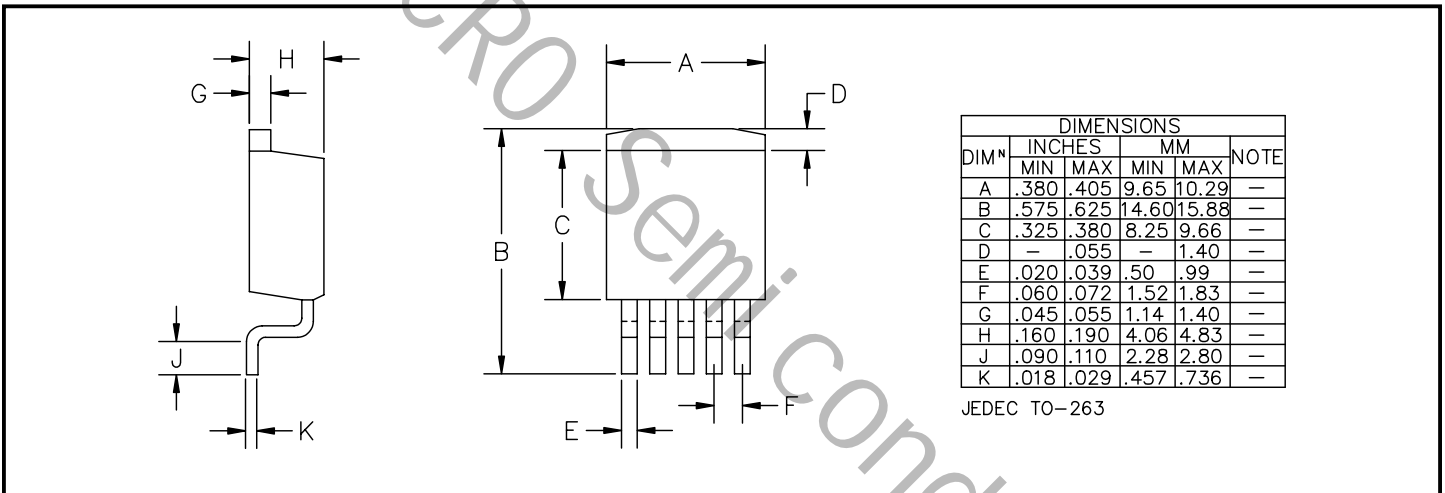

Minimum Land Pattern - TO-263-5

