



Continental Device India Pvt. Limited

An IATF 16949, ISO9001 and ISO 14001 Certified Company



High Power NPN Silicon Power Transistors

20&30 AMPERES, 40&60 VOLTS, 150 WATTS

2N3771

2N3772

TO-3

Metal Can Package

RoHS compliant



TO-3

FEATURES: Forward Biased Second Breakdown Current Capability

2N3771-- $I_{S/b} = 3.75 \text{ A dc @ } V_{CE} = 40 \text{ Vdc}$

2N3772 -- $I_{S/b} = 2.5 \text{ A dc @ } V_{CE} = 60 \text{ Vdc}$

APPLICATIONS: Linear amplifiers, series pass regulators, and inductive switching applications.

ABSOLUTE MAXIMUM RATINGS ($T_a = 25^\circ\text{C}$)

Rating	Symbol	2N3771	2N3772	Unit
Collector-Emitter Voltage	V_{CEO}	40	60	Vdc
Collector-Emitter Voltage	V_{CEX}	50	80	Vdc
Collector-Base Voltage	V_{CB}	50	100	Vdc
Emitter-Base Voltage	V_{EB}	5.0	7.0	Vdc
Collector Current — Continuous Peak	I_C	30 30	20 30	Adc
Base Current — Continuous Peak	I_B	7.5 15	5.0 15	Adc
Total Device Dissipation @ $T_C = 25^\circ\text{C}$ Derate above 25°C	P_D	150 0.855		Watts W/ $^\circ\text{C}$
Operating and Storage Junction Temperature Range	T_J, T_{stg}	-65 to +200		$^\circ\text{C}$

THERMAL CHARACTERISTICS

Characteristics	Symbol	2N3771, 2N3772	Unit
Thermal Resistance, Junction to Case	J_C	1.17	$^\circ\text{C/W}$

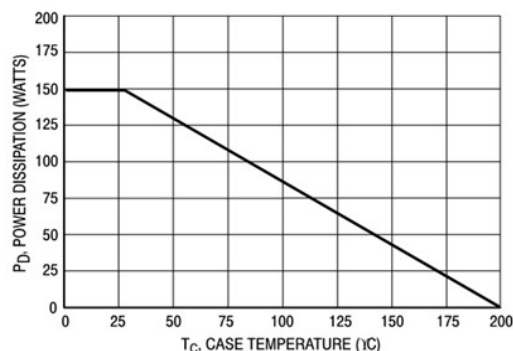

Figure 1. Power Derating

2N3771_2
Rev0_28042020EM



Continental Device India Pvt. Limited

An IATF 16949, ISO9001 and ISO 14001 Certified Company



ELECTRICAL CHARACTERISTICS ($T_A = 25^\circ\text{C}$ unless otherwise specified)

Characteristic	Symbol	Min	Max	Unit	
OFF CHARACTERISTICS					
*Collector–Emitter Sustaining Voltage (1) ($I_C = 0.2\text{ Adc}$, $I_B = 0$)	2N3771 2N3772	$V_{CEO(sus)}$	40 60	— —	Vdc
Collector–Emitter Sustaining Voltage ($I_C = 0.2\text{ Adc}$, $V_{EB(off)} = 1.5\text{ Vdc}$, $R_{BE} = 100\text{ Ohms}$)	2N3771 2N3772	$V_{CEX(sus)}$	50 80	— —	Vdc
Collector–Emitter Sustaining Voltage ($I_C = 0.2\text{ Adc}$, $R_{BE} = 100\text{ Ohms}$)	2N3771 2N3772	$V_{CER(sus)}$	45 70	— —	Vdc
*Collector Cutoff Current ($V_{CE} = 30\text{ Vdc}$, $I_B = 0$) ($V_{CE} = 50\text{ Vdc}$, $I_B = 0$) ($V_{CE} = 25\text{ Vdc}$, $I_B = 0$)	2N3771 2N3772	I_{CEO}	— —	10 10	mAdc
*Collector Cutoff Current ($V_{CE} = 50\text{ Vdc}$, $V_{EB(off)} = 1.5\text{ Vdc}$) ($V_{CE} = 100\text{ Vdc}$, $V_{EB(off)} = 1.5\text{ Vdc}$) ($V_{CE} = 45\text{ Vdc}$, $V_{EB(off)} = 1.5\text{ Vdc}$) ($V_{CE} = 30\text{ Vdc}$, $V_{EB(off)} = 1.5\text{ Vdc}$, $T_C = 150^\circ\text{C}$) ($V_{CE} = 45\text{ Vdc}$, $V_{EB(off)} = 1.5\text{ Vdc}$, $T_C = 150^\circ\text{C}$)	2N3771 2N3772 2N6257 2N3771 2N3772	I_{CEV}	— — — — —	2.0 5.0 4.0 10 10	mAdc
*Collector Cutoff Current ($V_{CB} = 50\text{ Vdc}$, $I_E = 0$) ($V_{CB} = 100\text{ Vdc}$, $I_E = 0$)	2N3771 2N3772	I_{CBO}	— —	2.0 5.0	mAdc
*Emitter Cutoff Current ($V_{BE} = 5.0\text{ Vdc}$, $I_C = 0$) ($V_{BE} = 7.0\text{ Vdc}$, $I_C = 0$)	2N3771 2N3772	I_{EBO}	— —	5.0 5.0	mAdc
*ON CHARACTERISTICS					
DC Current Gain (1) ($I_C = 15\text{ Adc}$, $V_{CE} = 4.0\text{ Vdc}$) ($I_C = 10\text{ Adc}$, $V_{CE} = 4.0\text{ Vdc}$) ($I_C = 8.0\text{ Adc}$, $V_{CE} = 4.0\text{ Vdc}$) ($I_C = 30\text{ Adc}$, $V_{CE} = 4.0\text{ Vdc}$) ($I_C = 20\text{ Adc}$, $V_{CE} = 4.0\text{ Vdc}$)	2N3771 2N3772 2N3771 2N3772	h_{FE}	15 15 5.0 5.0	60 60 — —	—
Collector–Emitter Saturation Voltage ($I_C = 15\text{ Adc}$, $I_B = 1.5\text{ Adc}$) ($I_C = 10\text{ Adc}$, $I_B = 1.0\text{ Adc}$) ($I_C = 30\text{ Adc}$, $I_B = 6.0\text{ Adc}$) ($I_C = 20\text{ Adc}$, $I_B = 4.0\text{ Adc}$)	2N3771 2N3772 2N3771 2N3772	$V_{CE(sat)}$	— — — —	2.0 1.4 4.0 4.0	Vdc
Base–Emitter On Voltage ($I_C = 15\text{ Adc}$, $V_{CE} = 4.0\text{ Vdc}$) ($I_C = 10\text{ Adc}$, $V_{CE} = 4.0\text{ Vdc}$) ($I_C = 8.0\text{ Adc}$, $V_{CE} = 4.0\text{ Vdc}$)	2N3771 2N3772	$V_{BE(on)}$	— —	2.7 2.2	Vdc
*DYNAMIC CHARACTERISTICS					
Current–Gain — Bandwidth Product ($I_C = 1.0\text{ Adc}$, $V_{CE} = 4.0\text{ Vdc}$, $f_{test} = 50\text{ kHz}$)		f_T	0.2	—	MHz
Small–Signal Current Gain ($I_C = 1.0\text{ Adc}$, $V_{CE} = 4.0\text{ Vdc}$, $f = 1.0\text{ kHz}$)		h_{fe}	40	—	—
SECOND BREAKDOWN					
Second Breakdown Energy with Base Forward Biased, $t = 1.0\text{ s}$ (non–repetitive) ($V_{CE} = 40\text{ Vdc}$) ($V_{CE} = 60\text{ Vdc}$)	2N3771 2N3772	$I_{S/b}$	3.75 2.5	— —	Adc

*Indicates JEDEC Registered Data.
(1) Pulse Test: 300 s, Rep. Rate 60 cps.

TYPICAL CHARACTERISTICS CURVES

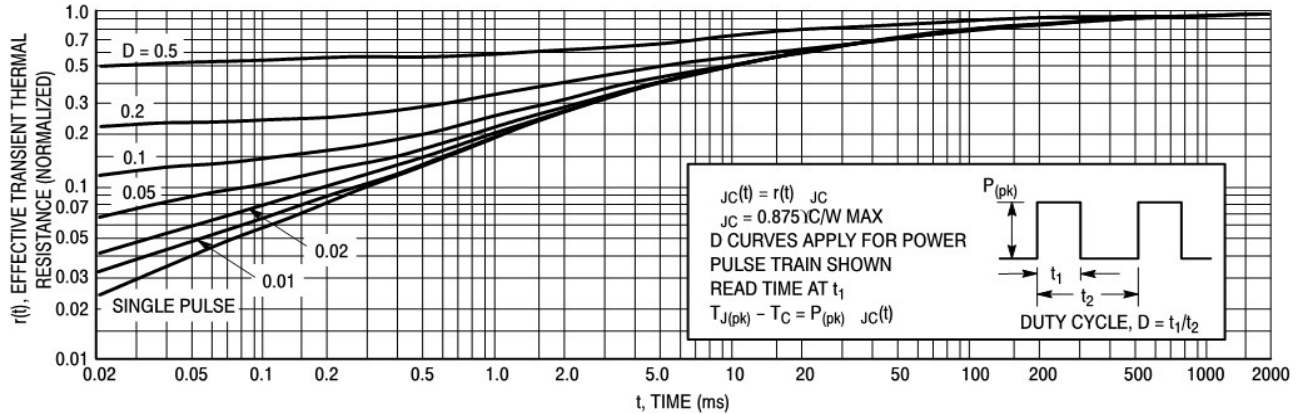

Figure 2. Thermal Response — 2N3771, 2N3772

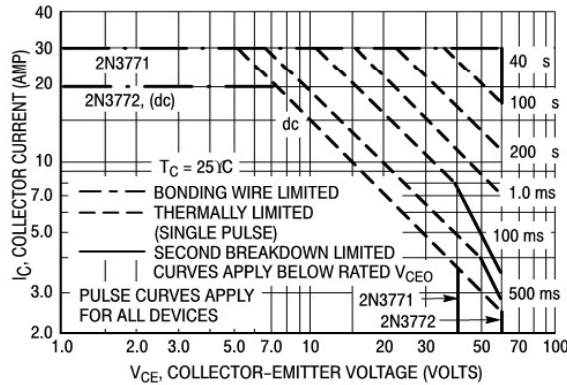

Figure 3. Active-Region Safe Operating Area — 2N3771, 2N3772

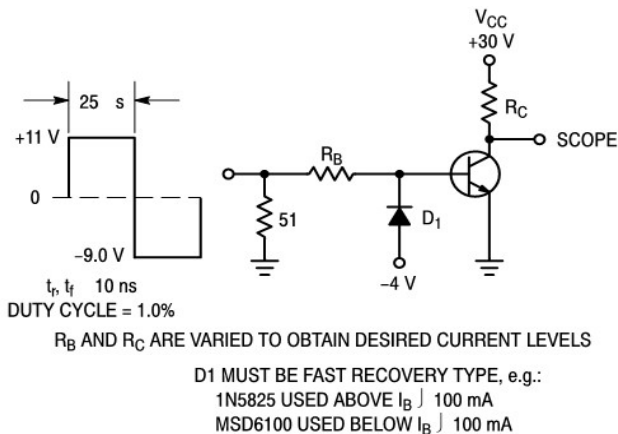

Figure 4. Switching Time Test Circuit

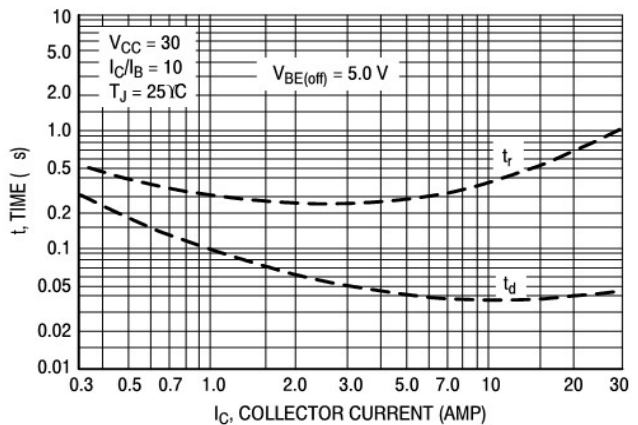

Figure 5. Turn-On Time



Continental Device India Pvt. Limited

An IATF 16949, ISO9001 and ISO 14001 Certified Company



TYPICAL CHARACTERISTICS CURVES

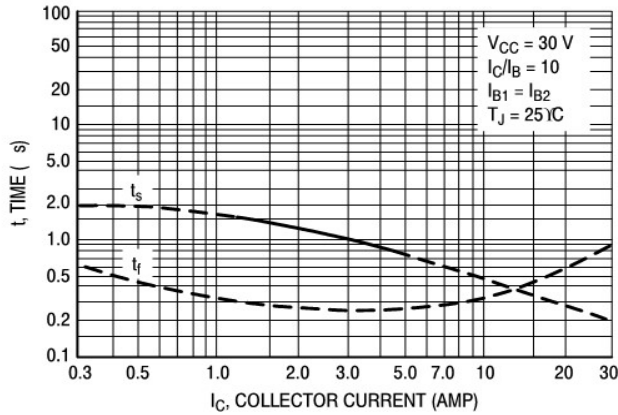

Figure 6. Turn-Off Time

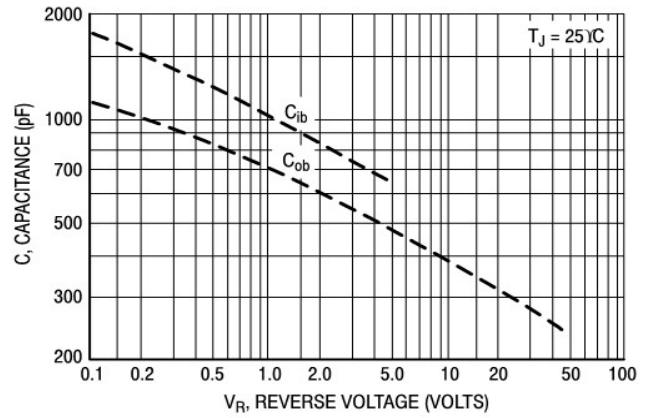

Figure 7. Capacitance

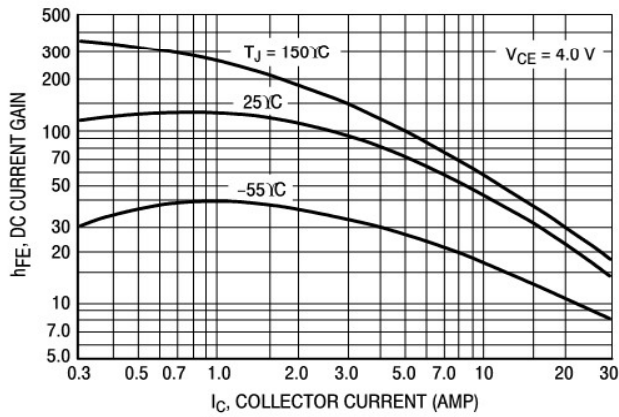

Figure 8. DC Current Gain

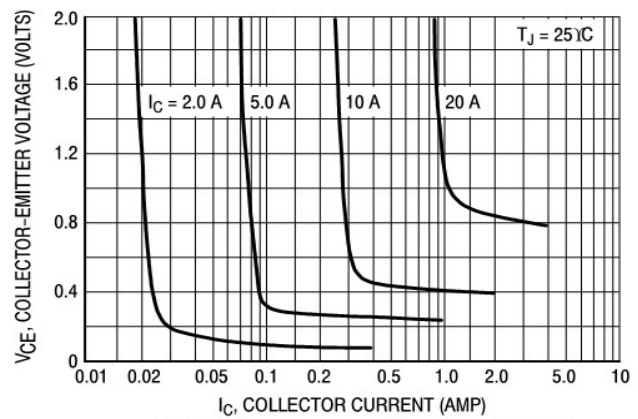
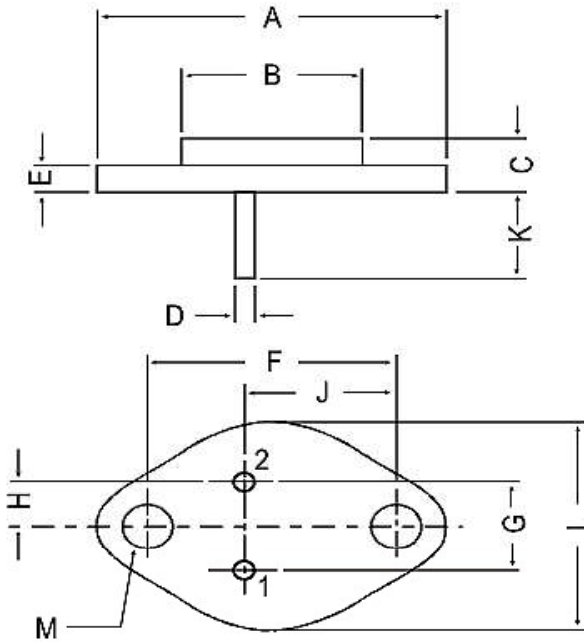

Figure 9. Collector Saturation Region

2N3771_2
Rev0_28042020EM

Package Details



All dimensions in mm.

DIM	MIN.	MAX.
A	—	39.37
B	—	22.22
C	6.35	8.50
D	0.96	1.09
E	—	1.77
F	29.90	30.40
G	10.69	11.18
H	5.20	5.72
J	16.64	17.15
K	11.15	12.25
L	—	26.67
M	3.84	4.19

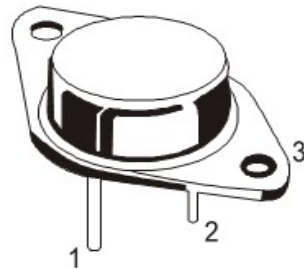

PIN CONFIGURATION

1. BASE
2. EMITTER
3. COLLECTOR

Packing Detail

PACKAGE	STANDARD PACK		INNER CARTON BOX		OUTER CARTON BOX		
	Details	Net Weight/Qty	Size	Qty	Size	Qty	Gr Wt
TO-3	100 pcs/pkt	1.3 kg/100 pcs	12.5" x 8" x 1.8"	0.1K	17" x 11.5" x 21"	2K	27.5 kgs



Continental Device India Pvt. Limited

An IATF 16949, ISO9001 and ISO 14001 Certified Company



Recommended Product Storage Environment for Discrete Semiconductor Devices

This storage environment assumes that the Diodes and transistors are packed properly inside the original packing supplied by CDIL.

- Temperature 5 °C to 30 °C
- Humidity between 40 to 70 %RH
- Air should be clean.
- Avoid harmful gas or dust.
- Avoid outdoor exposure or storage in areas subject to rain or water spraying .
- Avoid storage in areas subject to corrosive gas or dust. Product shall not be stored in areas exposed to direct sunlight.
- Avoid rapid change of temperature.
- Avoid condensation.
- Mechanical stress such as vibration and impact shall be avoided.
- The product shall not be placed directly on the floor.
- The product shall be stored on a plane area. They should not be turned upside down. They should not be placed against the wall.

Shelf Life of CDIL Products

The shelf life of products is the period from product manufacture to shipment to customers. The product can be unconditionally shipped within this period. The period is defined as 2 years.

If products are stored longer than the shelf life of 2 years the products shall be subjected to quality check as per CDIL quality procedure.

The products are further warranted for another one year after the date of shipment subject to the above conditions in CDIL original packing.

Floor Life of CDIL Products and MSL Level

When the products are opened from the original packing, the floor life will start.

For this, the following JEDEC table may be referred:

JEDEC MSL Level		
Level	Time	Condition
1	Unlimited	≤30 °C / 85% RH
2	1 Year	≤30 °C / 60% RH
2a	4 Weeks	≤30 °C / 60% RH
3	168 Hours	≤30 °C / 60% RH
4	72 Hours	≤30 °C / 60% RH
5	48 Hours	≤30 °C / 60% RH
5a	24 Hours	≤30 °C / 60% RH
6	Time on Label(TOL)	≤30 °C / 60% RH



Continental Device India Pvt. Limited

An IATF 16949, ISO9001 and ISO 14001 Certified Company



Customer Notes

Component Disposal Instructions

1. CDIL Semiconductor Devices are RoHS compliant, customers are requested to please dispose as per prevailing Environmental Legislation of their Country.
2. In Europe, please dispose as per EU Directive 2002/96/EC on Waste Electrical and Electronic Equipment (WEEE).

Disclaimer

The product information and the selection guides facilitate selection of the CDIL's Semiconductor Device(s) best suited for application in your product(s) as per your requirement. It is recommended that you completely review our Data Sheet(s) so as to confirm that the Device(s) meet functionality parameters for your application. The information furnished in the Data Sheet and on the CDIL Web Site/CD are believed to be accurate and reliable. CDIL however, does not assume responsibility for inaccuracies or incomplete information.

Furthermore, CDIL does not assume liability whatsoever, arising out of the application or use of any CDIL product; neither does it convey any license under its patent rights nor rights of others. These products are not designed for use in life saving/support appliances or systems. CDIL customers selling these products (either as individual Semiconductor Devices or incorporated in their end products), in any life saving/support appliances or systems or applications do so at their own risk and CDIL will not be responsible for any damages resulting from such sale(s).

CDIL strives for continuous improvement and reserves the right to change the specifications of its products without prior notice.



CDIL is a registered trademark of

Continental Device India Pvt. Limited

C-120 Naraina Industrial Area, New Delhi 110 028, India.

Telephone +91-11-2579 6150, 4141 1112 Fax +91-11-2579 5290, 4141 1119

email@cdil.com www.cdil.com

CIN No. U32109DL1964PTC004291

2N3771_2

Rev0_28042020EM