

**General Description**

This very high density process is tailored to minimize on-state resistance at low gate drive conditions. This device is designed especially for application in battery circuits using either one lithium or three cadmium or NMH cells. It can be used as an inverter or for high-efficiency miniature discrete DC/DC conversion in compact portable electronic devices like cellular phones and pagers. This device has excellent on-state resistance even at gate drive voltages as low as 2.5 volts.

**Features**

- $V_{DS} (V) = 25V$
- $I_D = 2A$
- $R_{DS(ON)} < 28m \Omega (V_{GS} = 4.5V)$
- $R_{DS(ON)} < 42m \Omega (V_{GS} = 2.7V)$
- Very low level gate drive requirements allowing direct operation in 3V circuits.  $V_{GS(th)} < 1V$ .
- Gate-Source Zener for ESD ruggedness.>6kV Human Body Model
- Compact industry standard SOT-23 surface mount package.

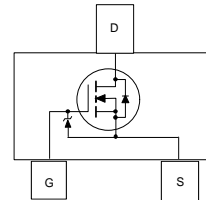
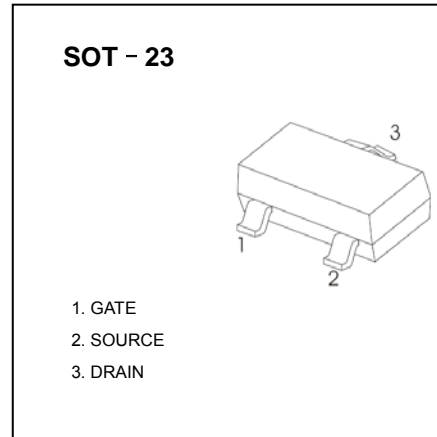

**Absolute Maximum Ratings**  $T_A = 25^{\circ}C$  unless other wise noted

Symbol	Parameter	FDV303N	Units
$V_{DSS}$	Drain-Source Voltage, Power Supply Voltage	25	V
$V_{GSS}$	Gate-Source Voltage, $V_{IN}$	8	V
$I_D$	Drain/Output Current	- Continuous	0.68
		- Pulsed	2
$P_D$	Maximum Power Dissipation	0.35	W
$T_J, T_{STG}$	Operating and Storage Temperature Range	-55 to 150	$^{\circ}C$
ESD	Electrostatic Discharge Rating MIL-STD-883D Human Body Model (100pf / 1500 Ohm)	6.0	kV
<b>THERMAL CHARACTERISTICS</b>			
$R_{\theta JA}$	Thermal Resistance, Junction-to-Ambient	357	$^{\circ}C/W$

**Electrical Characteristics** ( $T_A = 25\text{ }^\circ\text{C}$  unless otherwise noted)

Symbol	Parameter	Conditions	Min	Typ	Max	Units
<b>OFF CHARACTERISTICS</b>						
$BV_{DSS}$	Drain-Source Breakdown Voltage	$V_{GS} = 0\text{ V}, I_D = 250\text{ }\mu\text{A}$	25			V
$\Delta BV_{DSS}/\Delta T_J$	Breakdown Voltage Temp. Coefficient	$I_D = 250\text{ }\mu\text{A}$ , Referenced to $25\text{ }^\circ\text{C}$		26		mV / $^\circ\text{C}$
$I_{DSS}$	Zero Gate Voltage Drain Current	$V_{DS} = 20\text{ V}, V_{GS} = 0\text{ V}$ $T_J = 55\text{ }^\circ\text{C}$			1	$\mu\text{A}$
					10	$\mu\text{A}$
$I_{GSS}$	Gate - Body Leakage Current	$V_{GS} = 8\text{ V}, V_{DS} = 0\text{ V}$			100	nA
<b>ON CHARACTERISTICS</b> (Note)						
$\Delta V_{GS(th)}/\Delta T_J$	Gate Threshold Voltage Temp. Coefficient	$I_D = 250\text{ }\mu\text{A}$ , Referenced to $25\text{ }^\circ\text{C}$		-2.6		mV / $^\circ\text{C}$
$V_{GS(th)}$	Gate Threshold Voltage	$V_{DS} = V_{GS}, I_D = 250\text{ }\mu\text{A}$	0.65	0.8	1	V
$R_{DS(on)}$	Static Drain-Source On-Resistance	$V_{GS} = 4.5\text{ V}, I_D = 0.5\text{ A}$ $V_{GS} = 2.7\text{ V}, I_D = 0.2\text{ A}$			28	m $\Omega$
					42	
$I_{D(on)}$	On-State Drain Current	$V_{GS} = 2.7\text{ V}, V_{DS} = 5\text{ V}$	0.5			A
$g_{FS}$	Forward Transconductance	$V_{DS} = 5\text{ V}, I_D = 0.5\text{ A}$		1.45		S
<b>DYNAMIC CHARACTERISTICS</b>						
$C_{iss}$	Input Capacitance	$V_{DS} = 10\text{ V}, V_{GS} = 0\text{ V},$ $f = 1.0\text{ MHz}$		50		pF
$C_{oss}$	Output Capacitance			28		pF
$C_{rss}$	Reverse Transfer Capacitance			9		pF
<b>SWITCHING CHARACTERISTICS</b> (Note)						
$t_{D(on)}$	Turn - On Delay Time	$V_{DD} = 6\text{ V}, I_D = 0.5\text{ A},$ $V_{GS} = 4.5\text{ V}, R_{GEN} = 50\text{ }\Omega$		3	6	ns
$t_r$	Turn - On Rise Time			8.5	18	ns
$t_{D(off)}$	Turn - Off Delay Time			17	30	ns
$t_f$	Turn - Off Fall Time			13	25	ns
$Q_g$	Total Gate Charge	$V_{DS} = 5\text{ V}, I_D = 0.5\text{ A},$ $V_{GS} = 4.5\text{ V}$		1.64	2.3	nC
$Q_{gs}$	Gate-Source Charge			0.38		nC
$Q_{gd}$	Gate-Drain Charge			0.45		nC
<b>DRAIN-SOURCE DIODE CHARACTERISTICS AND MAXIMUM RATINGS</b>						
$I_S$	Maximum Continuous Drain-Source Diode Forward Current				0.3	A
$V_{SD}$	Drain-Source Diode Forward Voltage	$V_{GS} = 0\text{ V}, I_S = 0.5\text{ A}$ (Note)		0.83	1.2	V

Note:

 Pulse Test: Pulse Width  $\leq 300\mu\text{s}$ , Duty Cycle  $\leq 2.0\%$ .

Typical Electrical Characteristics

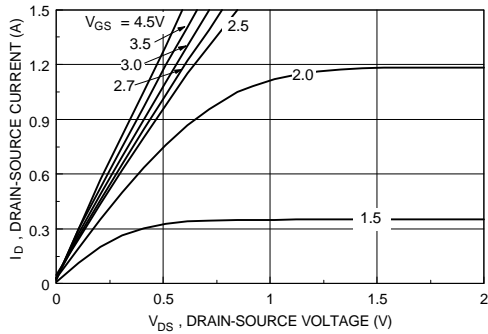

Figure 1. On-Region Characteristics.

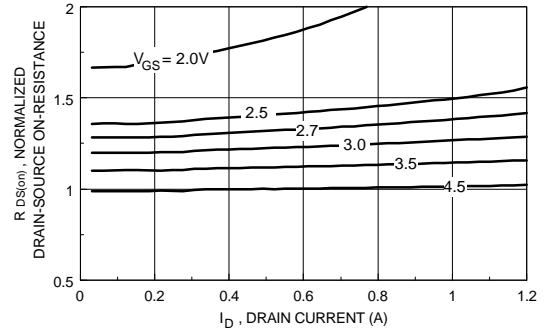

Figure 2. On-Resistance Variation with Drain Current and Gate Voltage.

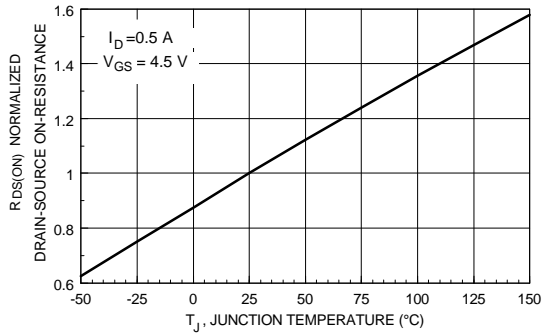

Figure 3. On-Resistance Variation with Temperature.

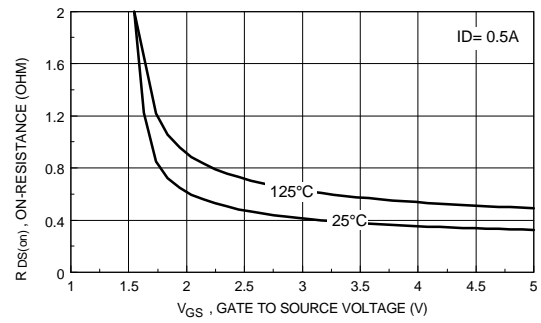

Figure 4. On Resistance Variation with Gate-To- Source Voltage.

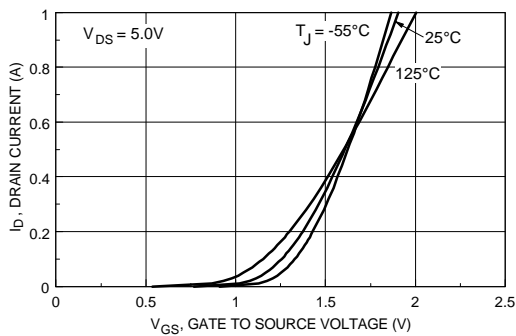

Figure 5. Transfer Characteristics.

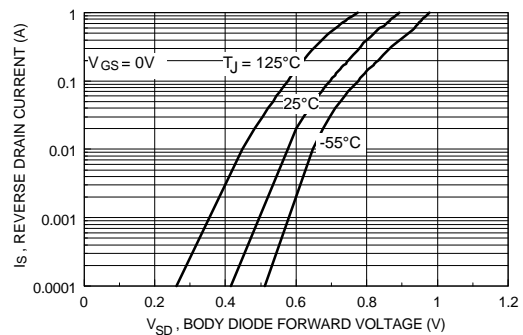

Figure 6. Body Diode Forward Voltage Variation with Source Current and Temperature.

Typical Electrical And Thermal Characteristics

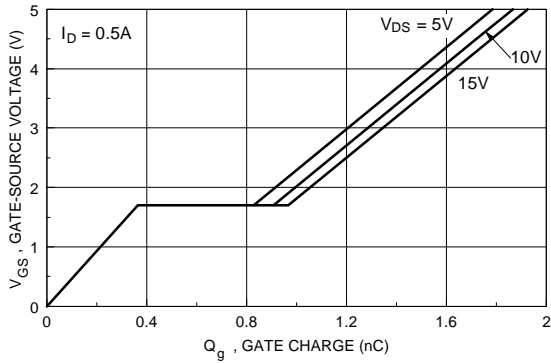

Figure 7. Gate Charge Characteristics.

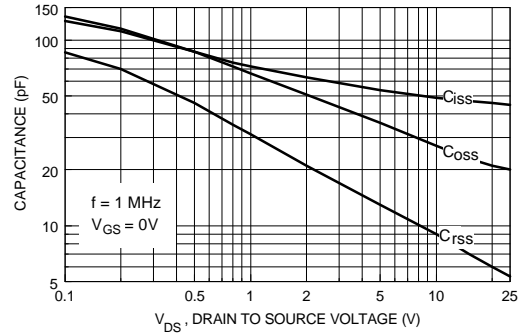

Figure 8. Capacitance Characteristics.

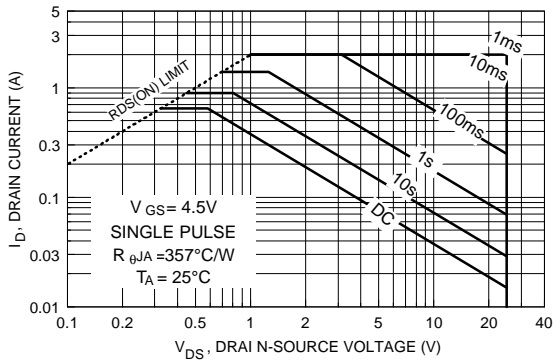

Figure 9. Maximum Safe Operating Area.

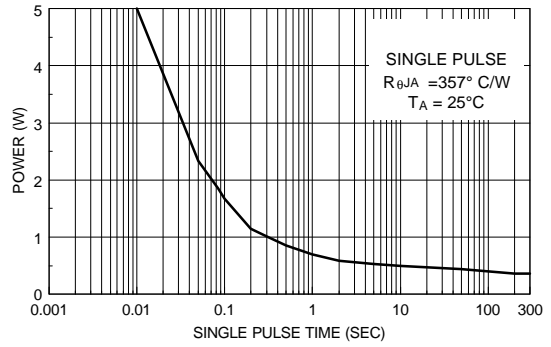

Figure 10. Single Pulse Maximum Power Dissipation.

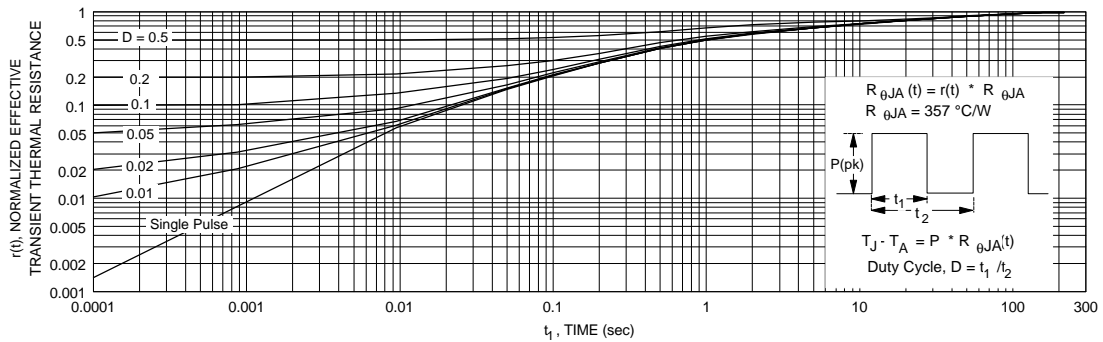
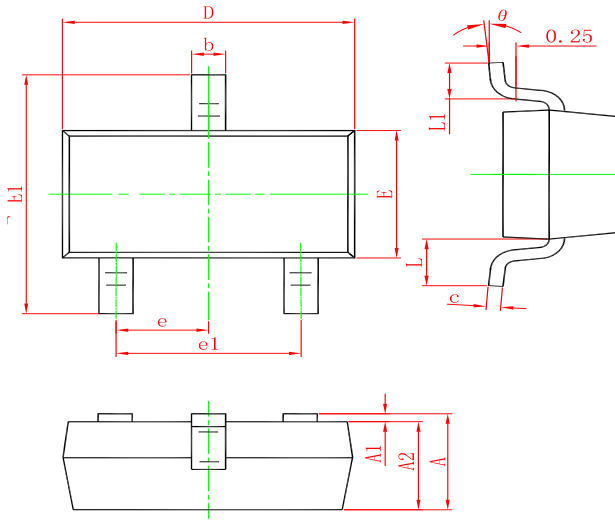

Figure 11. Transient Thermal Response Curve.

**SOT-23 PACKAGE OUTLINE DIMENSIONS**



Symbol	Dimensions In Millimeters		Dimensions In Inches	
	Min.	Max.	Min.	Max.
A	0.900	1.150	0.035	0.045
A1	0.000	0.100	0.000	0.004
A2	0.900	1.050	0.035	0.041
b	0.300	0.500	0.012	0.020
c	0.080	0.150	0.003	0.006
D	2.800	3.000	0.110	0.118
E	1.200	1.400	0.047	0.055
E1	2.250	2.550	0.089	0.100
e	0.950 TYP.		0.037 TYP.	
e1	1.800	2.000	0.071	0.079
L	0.550 REF.		0.022 REF.	
L1	0.300	0.500	0.012	0.020
θ	0°	8°	0°	8°

**Marking**

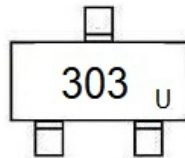

**Ordering information**

Order code	Package	Baseqty	Deliverymode
UMW FDV303N	SOT-23	3000	Tape and reel