

**-60 V P - Channel Enhancement Mode MOSFET**

**DESCRIPTION**

The IRFR5305TR uses advanced trench technology to provide excellent  $R_{DS(ON)}$  and low gate charge .This device is suitable for use as a load switch or in PWM applications.

**GENERAL FEATURES**

- $V_{DS} = -60V, I_D = -30A$
- $R_{DS(ON)} < 40m\Omega @ V_{GS} = -10V$
- $R_{DS(ON)} < 55m\Omega @ V_{GS} = -4.5V$
- High Power and current handing capability
- Lead free product is acquired
- Surface Mount Package

**Application**

- PWM applications
- Load switch
- Power management

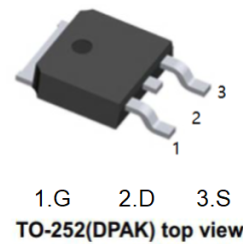
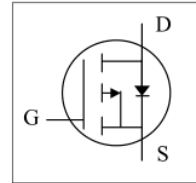

**ABSOLUTE MAXIMUM RATINGS(TA=25°C unless otherwise noted)**

Parameter	Symbol	Limit	Unit
Drain-Source Voltage	V <sub>DS</sub>	-60	V
Gate-Source Voltage	V <sub>GS</sub>	±20	V
Drain Current-Continuous@ Current-Pulsed (Note 1)	I <sub>D</sub> (25°C)	-30	A
	I <sub>D</sub> (70°C)	-20	A
	I <sub>DM</sub>	-60	A
Maximum Power Dissipation	P <sub>D</sub>	60	W
Operating Junction and Storage Temperature Range	T <sub>J</sub> ,T <sub>STG</sub>	-55 To 175	°C
Thermal Resistance,Junction-to-Ambient (Note 2)	R <sub>θJA</sub>	25	°C/W

## -60 V P -Channel Enhancement Mode MOSFET

### ELECTRICAL CHARACTERISTICS (TA=25°C unless otherwise noted)

Parameter	Symbol	Condition	Min	Typ	Max	Unit
Drain-Source Breakdown Voltage	BV <sub>DSS</sub>	V <sub>GS</sub> =0V, I <sub>D</sub> =-250μA	-60			V
Zero Gate Voltage Drain Current	I <sub>DSS</sub>	V <sub>DS</sub> =-48V, V <sub>GS</sub> =0V			-1	μA
Gate-Body Leakage Current	I <sub>GSS</sub>	V <sub>GS</sub> =±20V, V <sub>DS</sub> =0V			±100	nA
Gate Threshold Voltage	V <sub>GS(th)</sub>	V <sub>DS</sub> =V <sub>GS</sub> , I <sub>D</sub> =-250μA	-1	-1.8	-2.5	V
Drain-Source On-State Resistance	R <sub>DS(ON)</sub>	V <sub>GS</sub> =-10V, I <sub>D</sub> =-20A		31	40	mΩ
		V <sub>GS</sub> =-4.5V, I <sub>D</sub> =-20A		42	55	mΩ
Forward Transconductance	g <sub>FS</sub>	V <sub>DS</sub> =-5V, I <sub>D</sub> =-20A	5			S
Input Capacitance	C <sub>iss</sub>	V <sub>DS</sub> =-30V, V <sub>GS</sub> =0V, F=1.0MHz		3060		PF
Output Capacitance	C <sub>oss</sub>			300		PF
Reverse Transfer Capacitance	C <sub>rss</sub>			205		PF
Turn-on Delay Time	t <sub>d(on)</sub>	V <sub>DS</sub> =-30V, V <sub>GS</sub> =-10V, R <sub>GEN</sub> =3Ω I <sub>D</sub> =1A		14		nS
Turn-on Rise Time	t <sub>r</sub>			20		nS
Turn-Off Delay Time	t <sub>d(off)</sub>			40		nS
Turn-Off Fall Time	t <sub>f</sub>			19		nS
Total Gate Charge	Q <sub>g</sub>				48	
Gate-Source Charge	Q <sub>gs</sub>	V <sub>DS</sub> =-30V, I <sub>D</sub> =-20A, V <sub>GS</sub> =-10V		11		nC
Gate-Drain Charge	Q <sub>gd</sub>			10		nC
Body Diode Reverse Recovery Time	T <sub>rr</sub>	I <sub>F</sub> =-20A, dI/dt=100A/μs		40		nS
Body Diode Reverse Recovery Charge	Q <sub>rr</sub>			56		nC
Diode Forward Voltage (Note 3)	V <sub>SD</sub>	V <sub>GS</sub> =0V, I <sub>S</sub> =-1A		-0.72	-1	V

#### NOTES:

1. Repetitive Rating: Pulse width limited by maximum junction temperature.
2. Surface Mounted on 1in<sup>2</sup> FR4 Board, t ≤ 10 sec.
3. Pulse Test: Pulse Width ≤ 300μs, Duty Cycle ≤ 2%.
4. Guaranteed by design, not subject to production testing.

## TYPICAL ELECTRICAL AND THERMAL CHARACTERISTICS

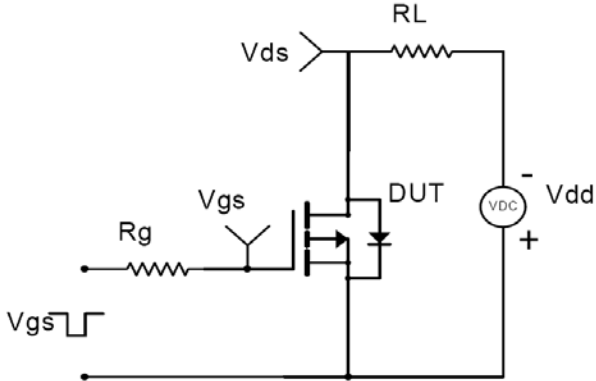

Figure 1: Switching Test Circuit

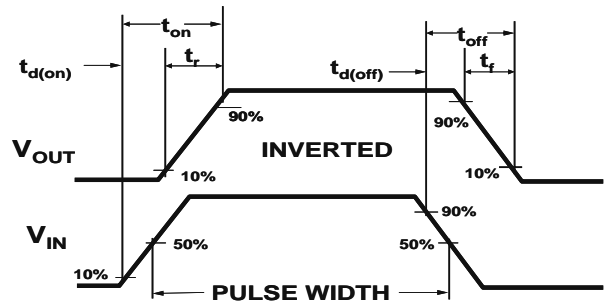

Figure 2: Switching Waveforms

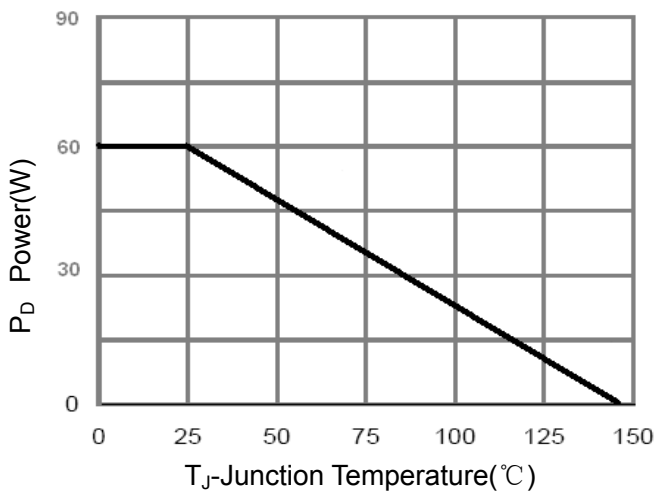

Figure 3 Power Dissipation

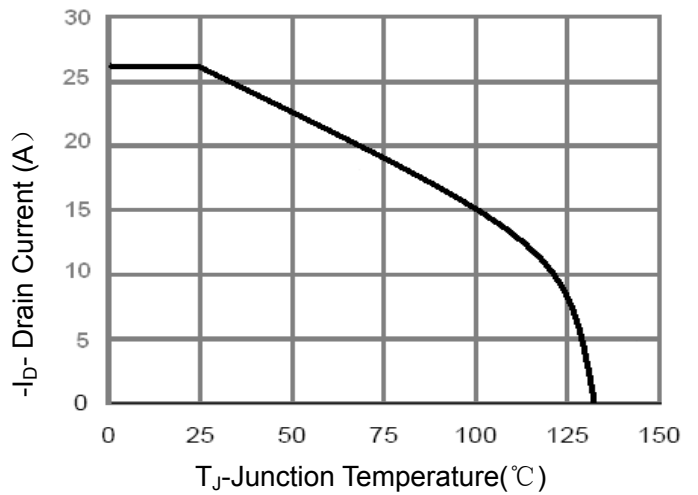

Figure 4 Drain Current

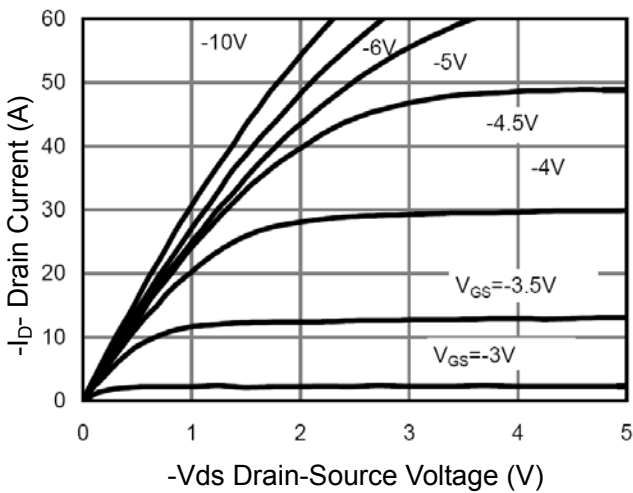

Figure 5 Output CHARACTERISTICS

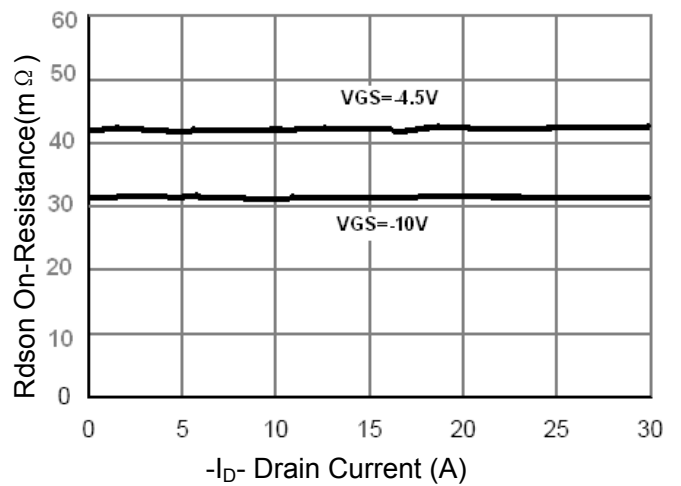

Figure 6 Drain-Source On-Resistance

60 V P-Channel Enhancement Mode MOSFET

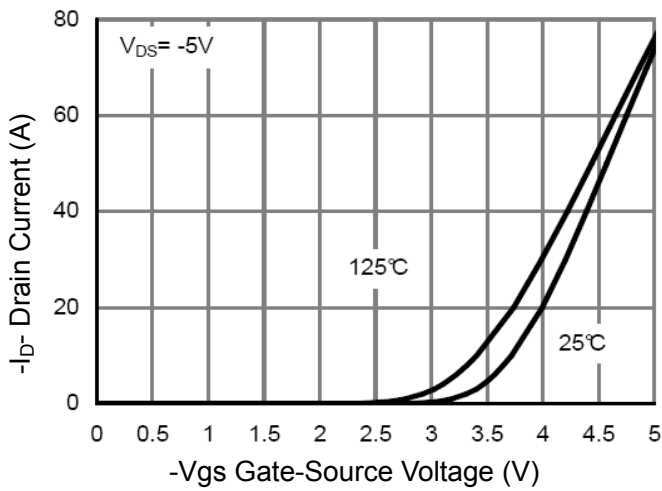

Figure 7 Transfer Characteristics

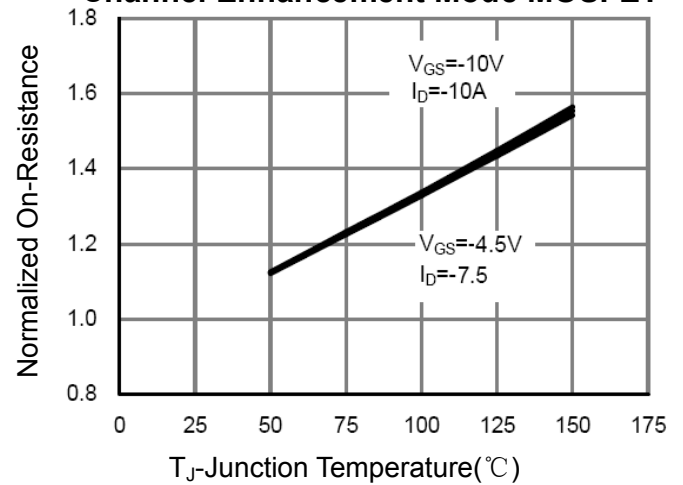

Figure 8 Drain-Source On-Resistance

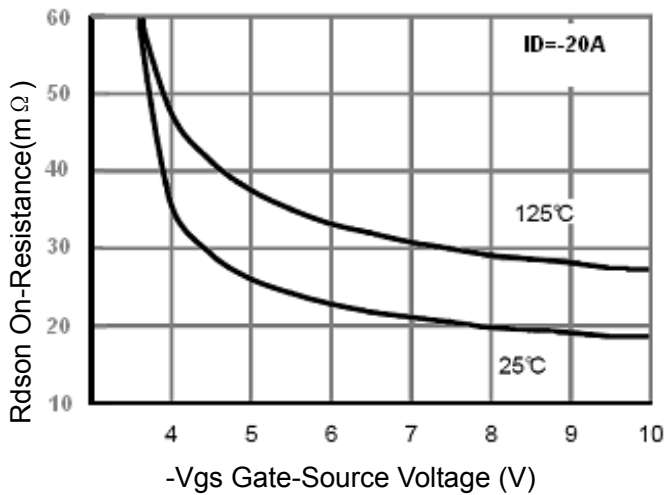

Figure 9  $R_{DS(on)}$  vs  $V_{GS}$

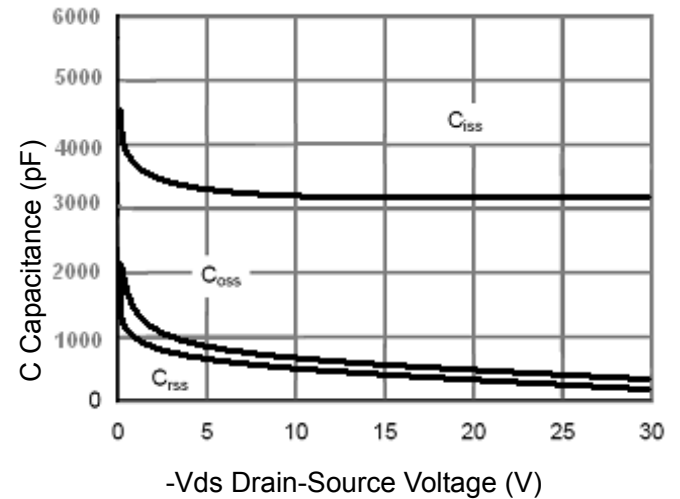

Figure 10 Capacitance vs  $V_{DS}$

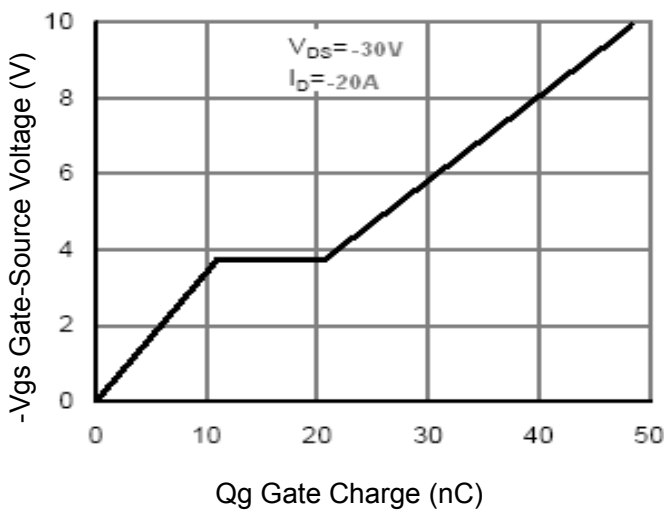

Figure 11 Gate Charge

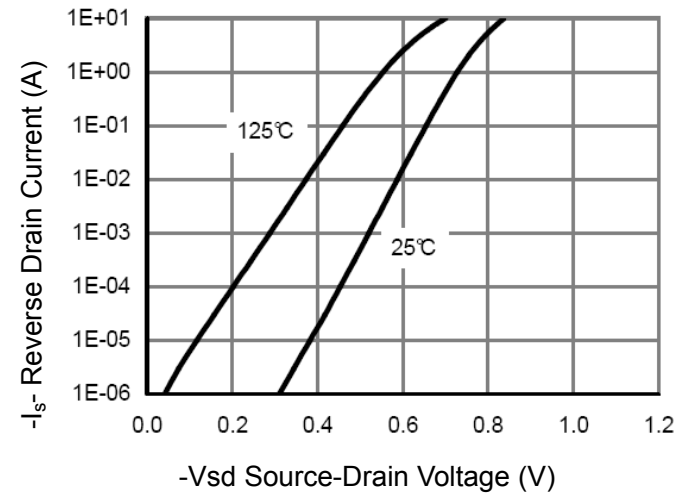

Figure 12 Source- Drain Diode Forward

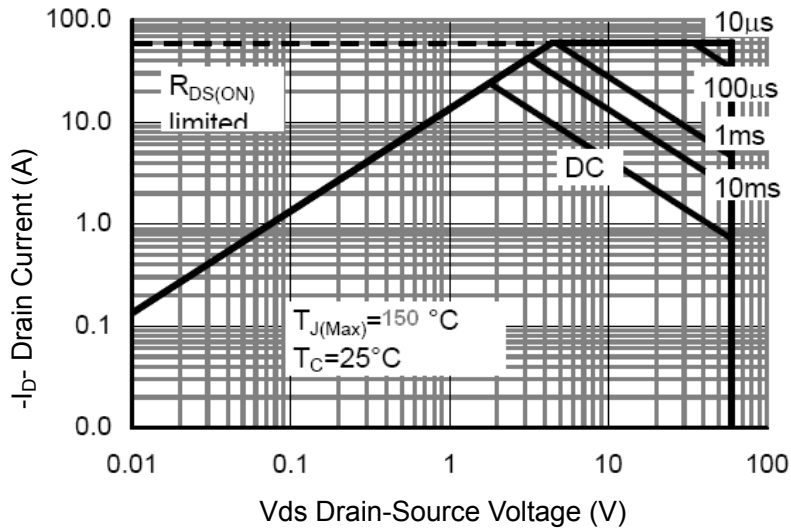

Figure 13 Safe Operation Area

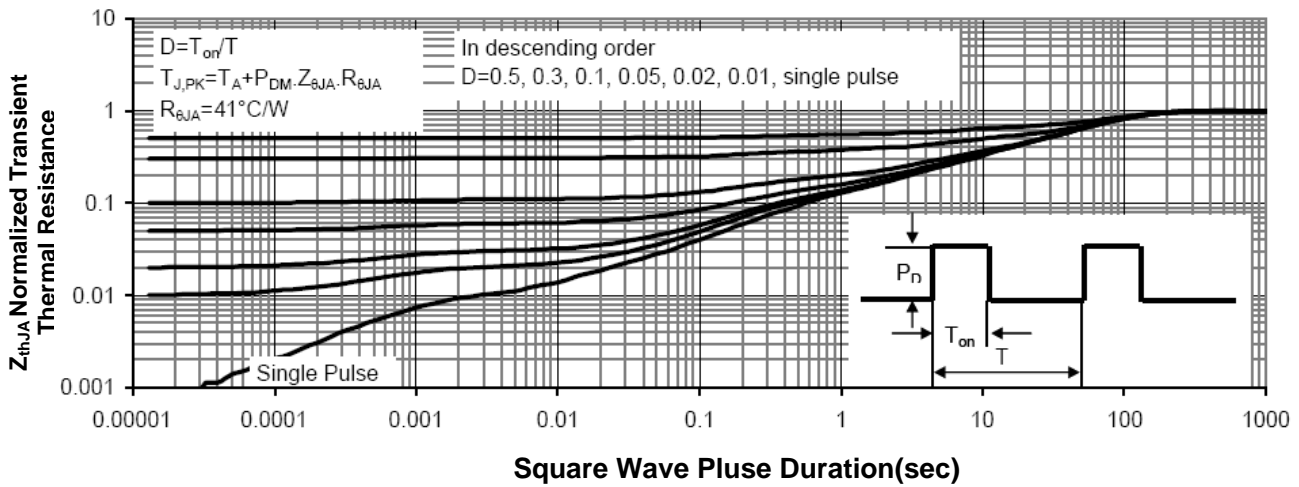
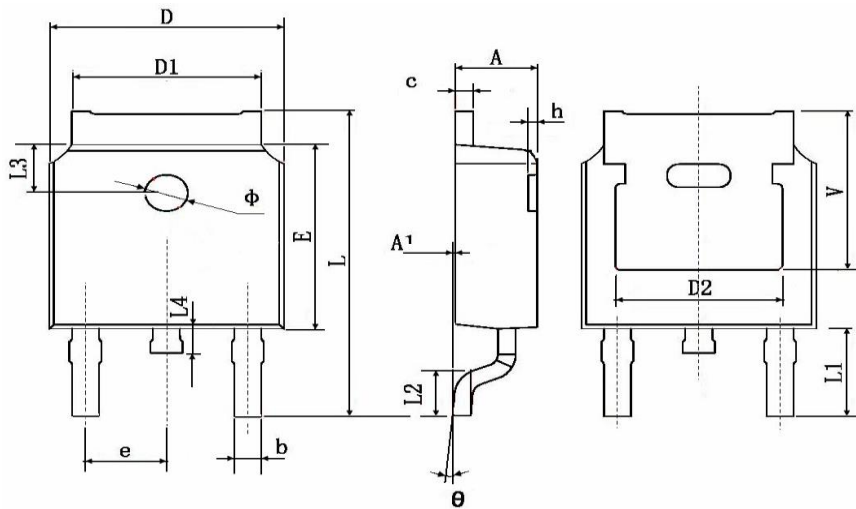

Figure 14 Normalized Maximum Transient Thermal Impedance

TO-252 Package Information



Symbol	Dimensions In Millimeters		Dimensions In Inches	
	Min.	Max.	Min.	Max.
A	2.200	2.400	0.087	0.094
A1	0.000	0.127	0.000	0.005
b	0.660	0.860	0.026	0.034
c	0.460	0.580	0.018	0.023
D	6.500	6.700	0.256	0.264
D1	5.100	5.460	0.201	0.215
D2	4.830 TYP.		0.190 TYP.	
E	6.000	6.200	0.236	0.244
e	2.186	2.386	0.086	0.094
L	9.800	10.400	0.386	0.409
L1	2.900 TYP.		0.114 TYP.	
L2	1.400	1.700	0.055	0.067
L3	1.600 TYP.		0.063 TYP.	
L4	0.600	1.000	0.024	0.039
Φ	1.100	1.300	0.043	0.051
θ	0°	8°	0°	8°
h	0.000	0.300	0.000	0.012
V	5.350 TYP.		0.211 TYP.	

### Marking

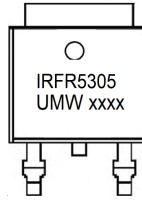

### Ordering information

Order code	Package	Baseqty	Deliverymode
UMW IRFR5305TR	TO-252	2500	Tape and reel