

N-Channel MOSFET

IRLML2402 (KRIML2402)

■ Features

- $V_{DS} (V) = 20V$
- $I_D = 1.2 A (V_{GS} = 4.5V)$
- $R_{DS(ON)} < 250m\Omega (V_{GS} = 4.5V)$
- $R_{DS(ON)} < 350m\Omega (V_{GS} = 2.7V)$

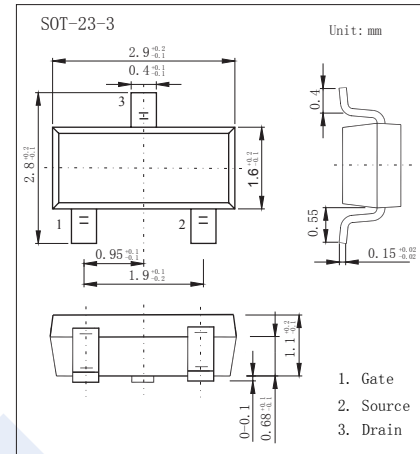
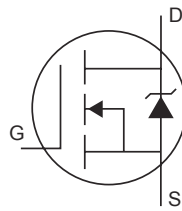

■ Absolute Maximum Ratings $T_a = 25^\circ C$

Parameter	Symbol	Rating	Unit	
Drain-Source Voltage	V_{DS}	20	V	
Gate-Source Voltage	V_{GS}	± 12		
Continuous Drain Current	I_D	$T_A=25^\circ C$	1.2	A
		$T_A=70^\circ C$	0.95	
Pulsed Drain Current	I_{DM}	7.4		
Power Dissipation	P_D	540	mW	
Linear Derating Factor		4.3	mW/ $^\circ C$	
Peak Diode Recovery dv/dt (Note.1)	dv/dt	5	V/ns	
Thermal Resistance Junction- to-Ambient	R_{thJA}	230	$^\circ C/W$	
Junction Temperature	T_J	150	$^\circ C$	
Storage Temperature Range	T_{stg}	-55 to 150		

Note.1: $I_{SD} \leq 0.93A$, $di/dt \leq 90A/\mu s$, $V_{DD} \leq V_{(BR)DSS}$, $T_J \leq 150^\circ C$

N-Channel MOSFET

IRLML2402 (KRIML2402)

■ Electrical Characteristics $T_a = 25^\circ\text{C}$

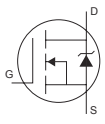
Parameter	Symbol	Test Conditions	Min	Typ	Max	Unit
Drain-Source Breakdown Voltage	V_{DS}	$I_D=250\ \mu\text{A}$, $V_{GS}=0\text{V}$	20			V
Zero Gate Voltage Drain Current	I_{DSS}	$V_{DS}=16\text{V}$, $V_{GS}=0\text{V}$			1	μA
		$V_{DS}=16\text{V}$, $V_{GS}=0\text{V}$, $T_J=125^\circ\text{C}$			25	
Gate-Body Leakage Current	I_{GSS}	$V_{DS}=0\text{V}$, $V_{GS}=\pm 12\text{V}$			± 100	nA
Gate Threshold Voltage	$V_{GS(th)}$	$V_{DS}=V_{GS}$, $I_D=250\ \mu\text{A}$	0.7		1.5	V
Static Drain-Source On-Resistance	$R_{DS(on)}$	$V_{GS}=4.5\text{V}$, $I_D=0.93\text{A}$ (Note.1)			250	m Ω
		$V_{GS}=2.7\text{V}$, $I_D=0.47\text{A}$ (Note.1)			350	
Forward Transconductance	g_{FS}	$V_{DS}=10\text{V}$, $I_D=0.47\text{A}$	1.3			S
Input Capacitance	C_{iss}	$V_{GS}=0\text{V}$, $V_{DS}=15\text{V}$, $f=1\text{MHz}$		110		pF
Output Capacitance	C_{oss}			51		
Reverse Transfer Capacitance	C_{rss}			25		
Total Gate Charge	Q_g	$V_{GS}=16\text{V}$, $V_{DS}=4.5\text{V}$, $I_D=0.93\text{A}$ (Note.1)		2.6	3.9	nC
Gate Source Charge	Q_{gs}			0.41	0.62	
Gate Drain Charge	Q_{gd}			1.1	1.7	
Turn-On DelayTime	$t_{d(on)}$	$V_{DS}=10\text{V}$, $I_D=0.93\text{A}$, $R_D=11\ \Omega$, $R_G=6.2\ \Omega$ (Note.1)		2.5		ns
Turn-On Rise Time	t_r			9.5		
Turn-Off DelayTime	$t_{d(off)}$			9.7		
Turn-Off Fall Time	t_f			4.8		
Body Diode Reverse Recovery Time	t_{rr}	$I_F=0.93\text{A}$, $dI/dt=100\text{A}/\mu\text{s}$, $T_J=25^\circ\text{C}$ (Note.1)		25	38	nC
Body Diode Reverse Recovery Charge	Q_{rr}			16	24	
Maximum Body-Diode Continuous Current	I_S	MOSFET symbol showing the integral reverse p-n junction diode. 			0.54	A
Pulse Source Current (Body Diode)	I_{SM}				7.4	
Diode Forward Voltage	V_{SD}	$I_S=0.93\text{A}$, $V_{GS}=0\text{V}$, $T_J=25^\circ\text{C}$ (Note.1)			1.2	V

Note.1: Pulse width $\leq 300\ \mu\text{s}$; duty cycle $\leq 2\%$.

■ Marking

Marking	1A**
---------	------

N-Channel MOSFET IRLML2402 (KRIML2402)

■ Typical Characteristics

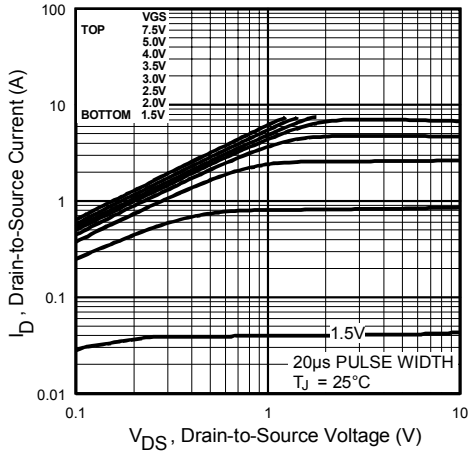

Fig 1. Typical Output Characteristics

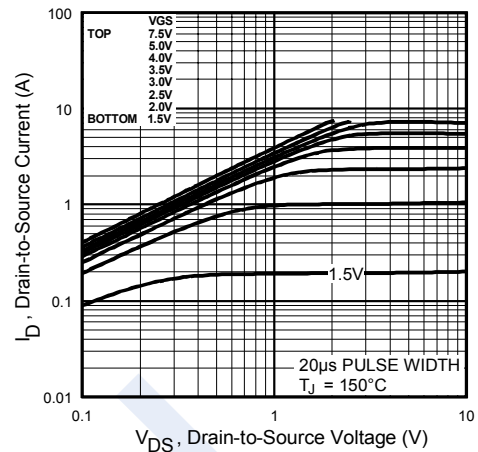

Fig 2. Typical Output Characteristics

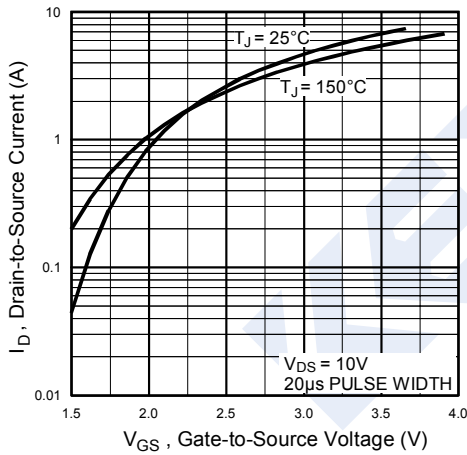

Fig 3. Typical Transfer Characteristics

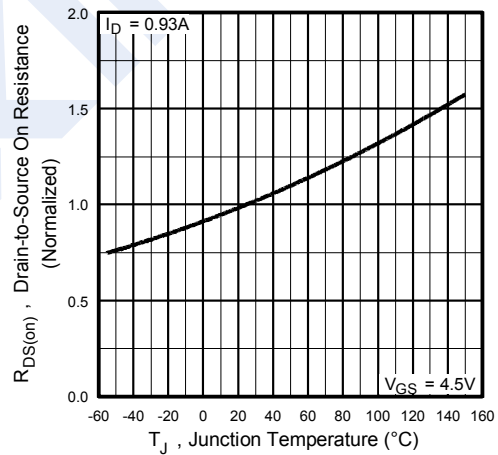

Fig 4. Normalized On-Resistance Vs. Temperature

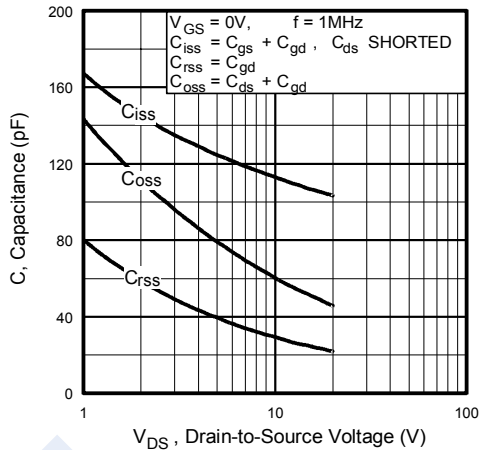

Fig 5. Typical Capacitance Vs. Drain-to-Source Voltage

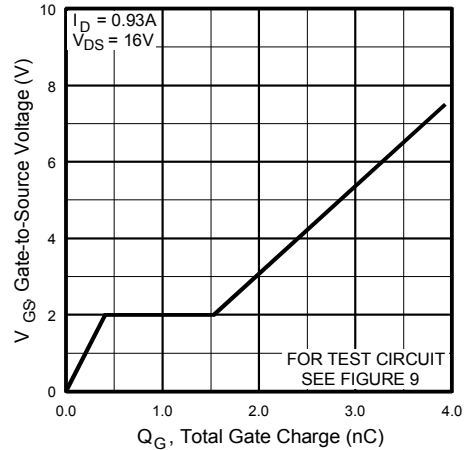

Fig 6. Typical Gate Charge Vs. Gate-to-Source Voltage

N-Channel MOSFET IRLML2402 (KRIML2402)

■ Typical Characteristics

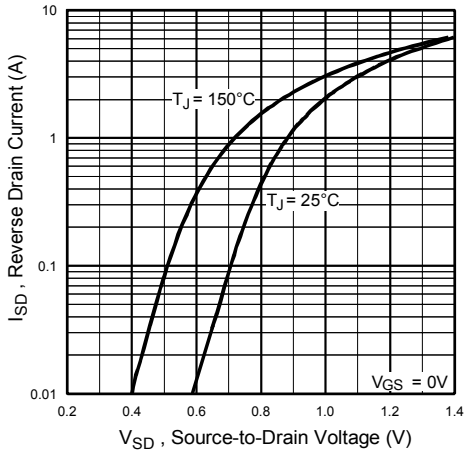

Fig 7. Typical Source-Drain Diode Forward Voltage

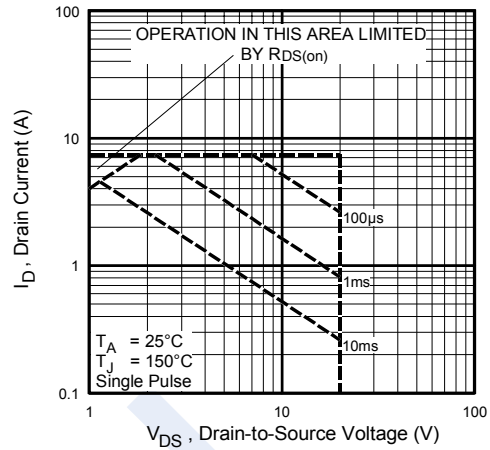

Fig 8. Maximum Safe Operating Area

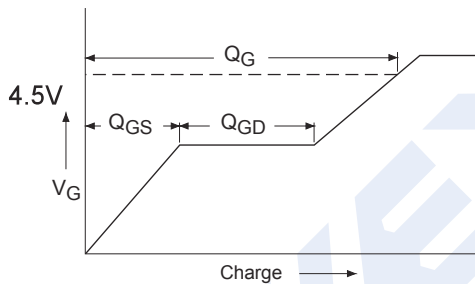

Fig 9a. Basic Gate Charge Waveform

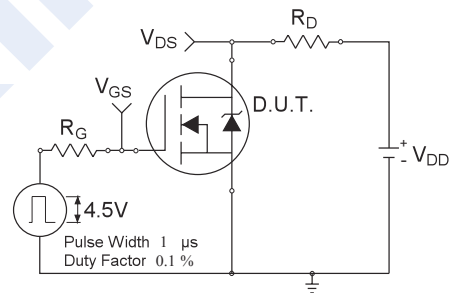

Fig 10a. Switching Time Test Circuit

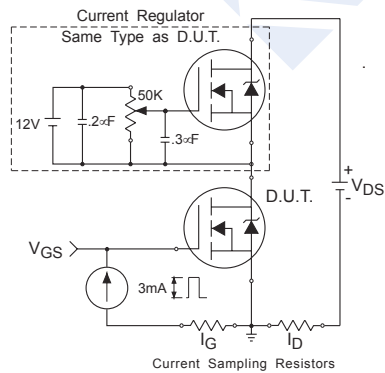

Fig 9b. Gate Charge Test Circuit

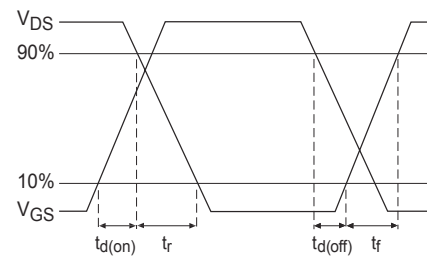

Fig 10b. Switching Time Waveforms

N-Channel MOSFET IRLML2402 (KRIML2402)

■ Typical Characteristics

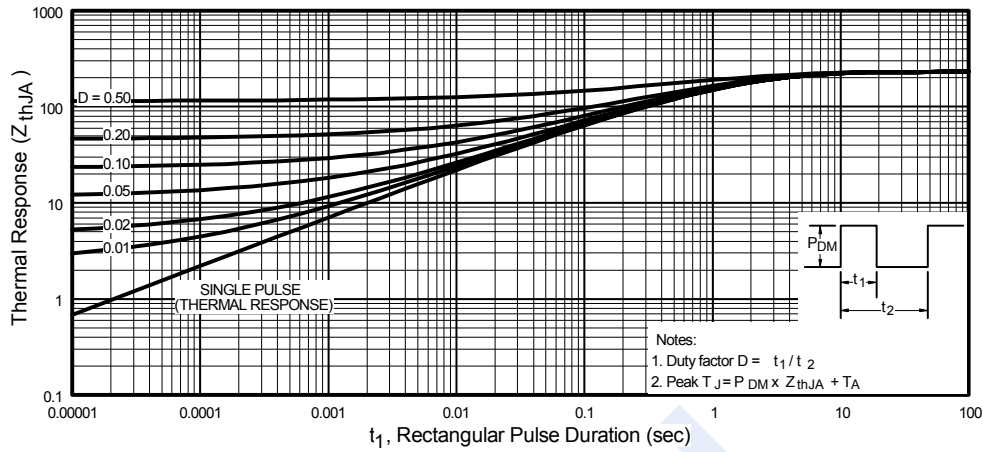
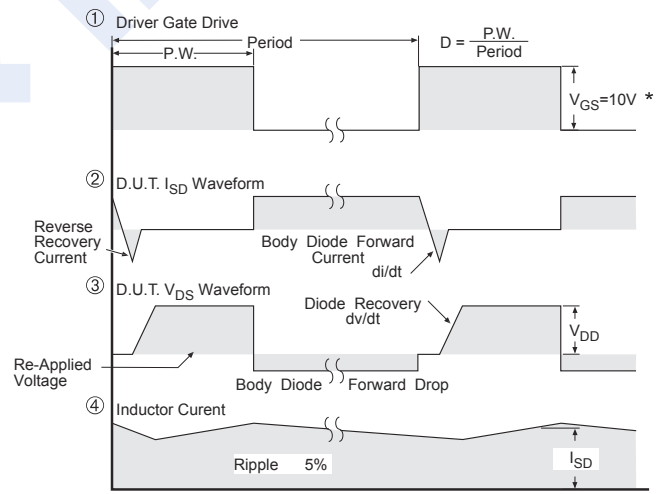
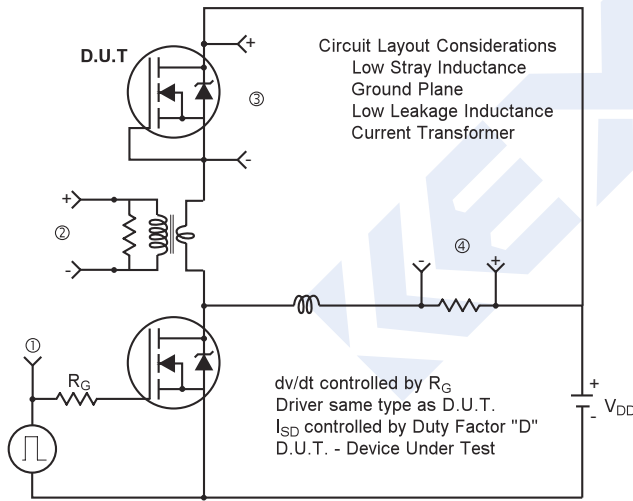

Fig 11. Maximum Effective Transient Thermal Impedance, Junction-to-Ambient

Peak Diode Recovery dv/dt Test Circuit



* $V_{GS} = 5V$ for Logic Level Devices

Fig 12. For N-Channel HEXFETS