

Description

The D-PAK is designed for surface mounting using vapor phase, infrared, or wave soldering techniques.

Power dissipation levels up to 1.5 watts are possible in typical surface mount applications.

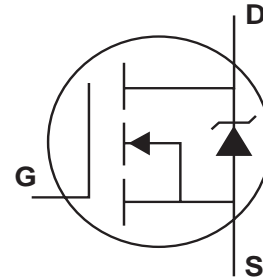

Features

$V_{DS} (V) = 100V$

$I_D = 17A (V_{GS} = 10V)$

$R_{DS(ON)} = 105m\Omega (V_{GS} = 10V)$

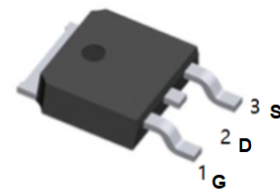

TO-252(DPAK) top view

Absolute Maximum Ratings

| | Parameter | Max. | Units |
|---------------------------|--|--------------|-------|
| $I_D @ T_C = 25^\circ C$ | Continuous Drain Current, $V_{GS} @ 10V$ | 17 | A |
| $I_D @ T_C = 100^\circ C$ | Continuous Drain Current, $V_{GS} @ 10V$ | 12 | |
| I_{DM} | Pulsed Drain Current ①⑤ | 60 | |
| $P_D @ T_C = 25^\circ C$ | Power Dissipation | 79 | W |
| | Linear Derating Factor | 0.53 | W/°C |
| V_{GS} | Gate-to-Source Voltage | ± 16 | V |
| E_{AS} | Single Pulse Avalanche Energy②⑤ | 150 | mJ |
| I_{AR} | Avalanche Current①⑤ | 9.0 | A |
| E_{AR} | Repetitive Avalanche Energy①⑤ | 7.9 | mJ |
| dv/dt | Peak Diode Recovery dv/dt ③ | 5.0 | V/ns |
| T_J | Operating Junction and | -55 to + 175 | °C |
| T_{STG} | Storage Temperature Range | | |
| | Soldering Temperature, for 10 seconds | | |

Thermal Resistance

| | Parameter | Typ. | Max. | Units |
|-----------------|------------------------------------|------|------|-------|
| $R_{\theta JC}$ | Junction-to-Case | — | 1.9 | °C/W |
| $R_{\theta JA}$ | Junction-to-Ambient (PCB mount) ** | — | 50 | |
| $R_{\theta JA}$ | Junction-to-Ambient | — | 110 | |

Electrical Characteristics @ T_J = 25°C (unless otherwise specified)

| | Parameter | Min. | Typ. | Max. | Units | Conditions |
|--------------------------------------|--------------------------------------|------|-------|------|-------|--|
| V _{(BR)DSS} | Drain-to-Source Breakdown Voltage | 100 | — | — | V | V _{GS} = 0V, I _D = 250μA |
| ΔV _{(BR)DSS/ΔT_J} | Breakdown Voltage Temp. Coefficient | — | 0.122 | — | V/°C | Reference to 25°C, I _D = 1mA |
| R _{DS(on)} | Static Drain-to-Source On-Resistance | — | — | 105 | mW | V _{GS} = 10V, I _D = 10A ④ |
| | | — | — | 125 | | V _{GS} = 5.0V, I _D = 10A ④ |
| | | — | — | 155 | | V _{GS} = 4.0V, I _D = 9.0A ④ |
| V _{GS(th)} | Gate Threshold Voltage | 1.0 | — | 2.0 | V | V _{DS} = V _{GS} , I _D = 250μA |
| g _{fs} | Forward Transconductance | 7.7 | — | — | S | V _{DS} = 25V, I _D = 9.0A⑤ |
| I _{DSS} | Drain-to-Source Leakage Current | — | — | 25 | μA | V _{DS} = 100V, V _{GS} = 0V |
| | | — | — | 250 | | V _{DS} = 80V, V _{GS} = 0V, T _J = 150°C |
| I _{GSS} | Gate-to-Source Forward Leakage | — | — | 100 | nA | V _{GS} = 16V |
| | Gate-to-Source Reverse Leakage | — | — | -100 | | V _{GS} = -16V |
| Q _g | Total Gate Charge | — | — | 34 | nC | I _D = 9.0A |
| Q _{gs} | Gate-to-Source Charge | — | — | 4.8 | | V _{DS} = 80V |
| Q _{gd} | Gate-to-Drain ("Miller") Charge | — | — | 20 | | V _{GS} = 5.0V, See Fig. 6 and 13 ④⑤ |
| t _{d(on)} | Turn-On Delay Time | — | 7.2 | — | ns | V _{DD} = 50V |
| t _r | Rise Time | — | 53 | — | | I _D = 9.0A |
| t _{d(off)} | Turn-Off Delay Time | — | 30 | — | | R _G = 6.0Ω, V _{GS} = 5.0V |
| t _f | Fall Time | — | 26 | — | | R _D = 5.5Ω, See Fig. 10 ④⑤ |
| L _D | Internal Drain Inductance | — | 4.5 | — | nH | Between lead, 6mm (0.25in.) from package and center of die contact⑥ |
| L _S | Internal Source Inductance | — | 7.5 | — | | |
| C _{iss} | Input Capacitance | — | 800 | — | pF | V _{GS} = 0V |
| C _{oss} | Output Capacitance | — | 160 | — | | V _{DS} = 25V |
| C _{rss} | Reverse Transfer Capacitance | — | 90 | — | | f = 1.0MHz, See Fig. 5⑤ |

Source-Drain Ratings and Characteristics

| | Parameter | Min. | Typ. | Max. | Units | Conditions |
|-----------------|---|--|------|------|-------|---|
| I _S | Continuous Source Current (Body Diode) | — | — | 17 | A | MOSFET symbol showing the integral reverse p-n junction diode. |
| I _{SM} | Pulsed Source Current (Body Diode) ①⑤ | — | — | 60 | | |
| V _{SD} | Diode Forward Voltage | — | — | 1.3 | V | T _J = 25°C, I _S = 9.0A, V _{GS} = 0V ④ |
| t _{rr} | Reverse Recovery Time | — | 140 | 210 | ns | T _J = 25°C, I _F = 9.0A |
| Q _{rr} | Reverse Recovery Charge | — | 740 | 1100 | nC | di/dt = 100A/μs ④⑤ |
| t _{on} | Forward Turn-On Time | Intrinsic turn-on time is negligible (turn-on is dominated by L _S +L _D) | | | | |

Notes:

- ① Repetitive rating; pulse width limited by max. junction temperature. (See fig. 11)
- ② V_{DD} = 25V, starting T_J = 25°C, L = 3.1mH R_G = 25Ω, I_{AS} = 9.0A. (See Figure 12)
- ③ I_{SD} ≤ 9.0A, di/dt ≤ 540A/μs, V_{DD} ≤ V_{(BR)DSS}, T_J ≤ 175°C
- ④ Pulse width ≤ 300μs; duty cycle ≤ 2%
- ⑤ Uses IRL530N data and test conditions
- ⑥ This is applied for I-PAK, L_S of D-PAK is measured between lead and center of die contact

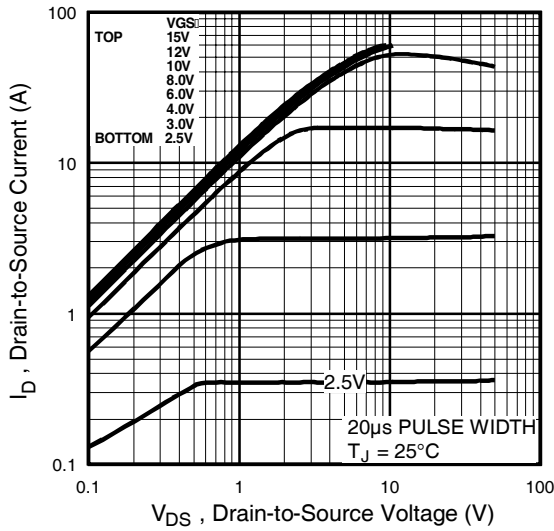

Fig 1. Typical Output Characteristics

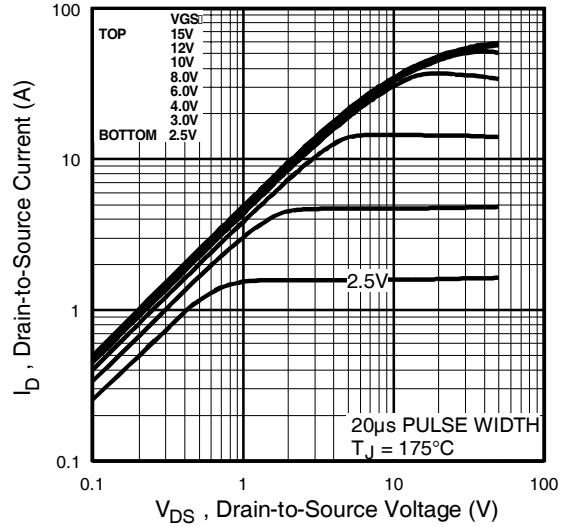

Fig 2. Typical Output Characteristics

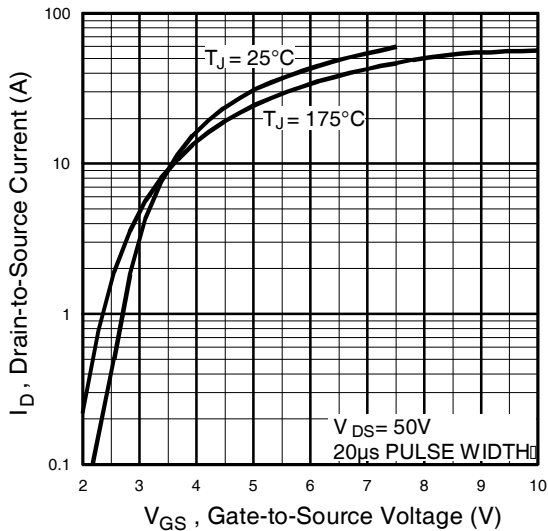

Fig 3. Typical Transfer Characteristics

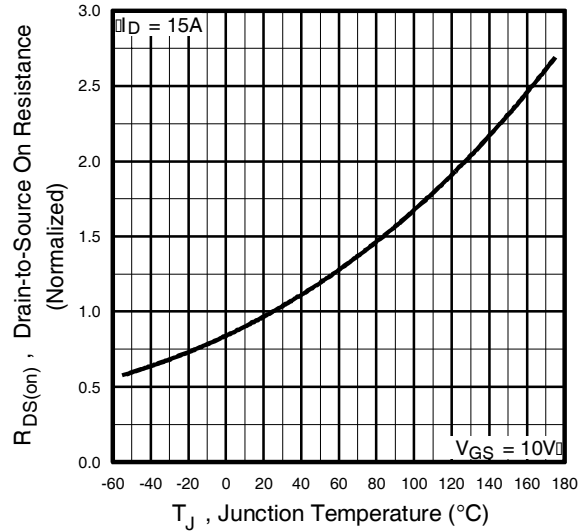

Fig 4. Normalized On-Resistance Vs. Temperature

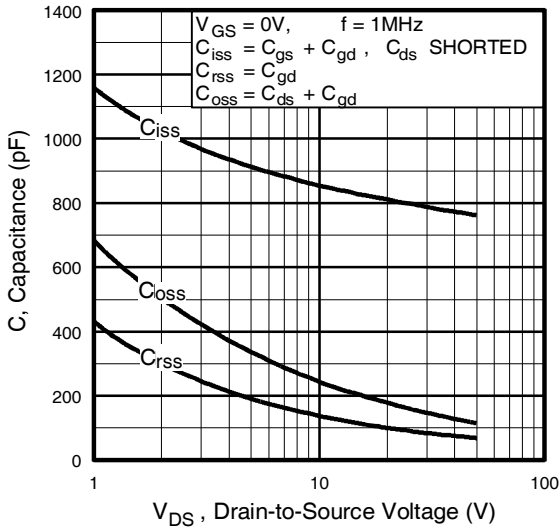

Fig 5. Typical Capacitance Vs. Drain-to-Source Voltage

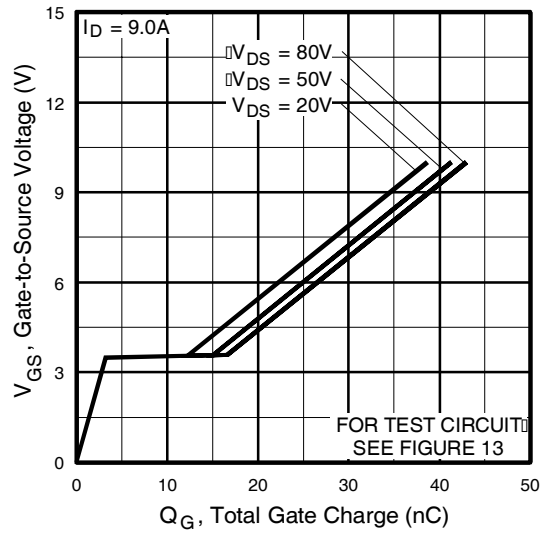

Fig 6. Typical Gate Charge Vs. Gate-to-Source Voltage

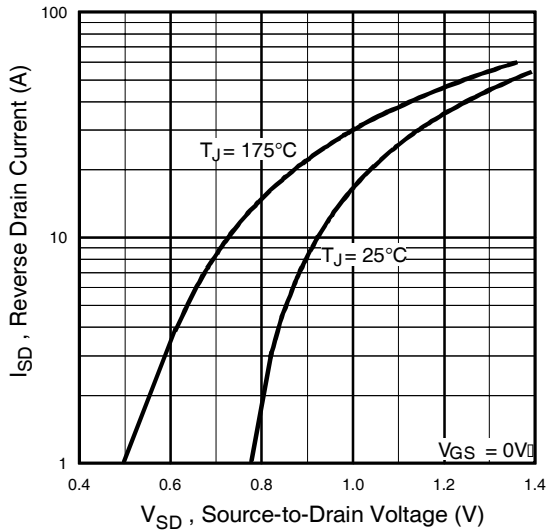

Fig 7. Typical Source-Drain Diode Forward Voltage

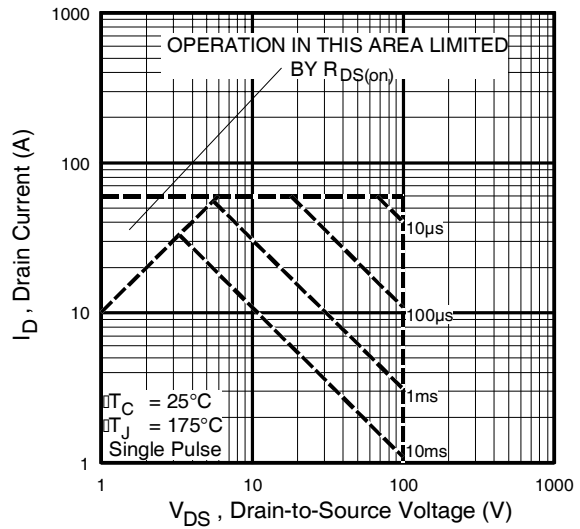

Fig 8. Maximum Safe Operating Area

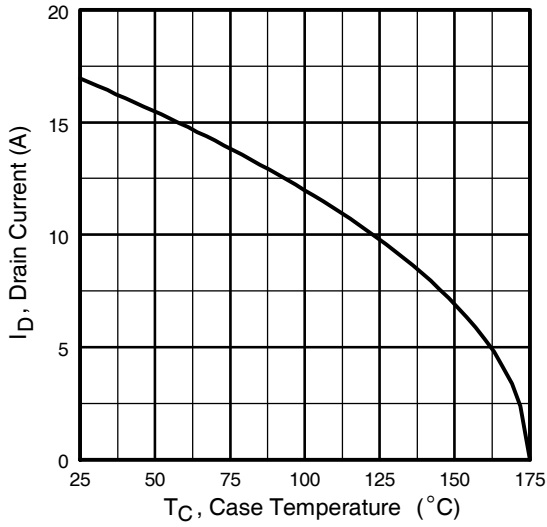

Fig 9. Maximum Drain Current Vs. Case Temperature

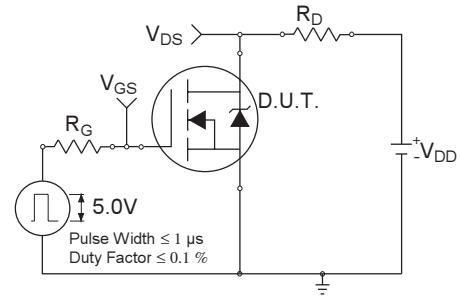

Fig 10a. Switching Time Test Circuit

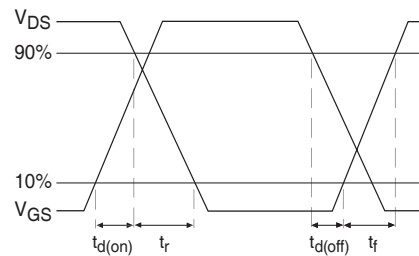

Fig 10b. Switching Time Waveforms

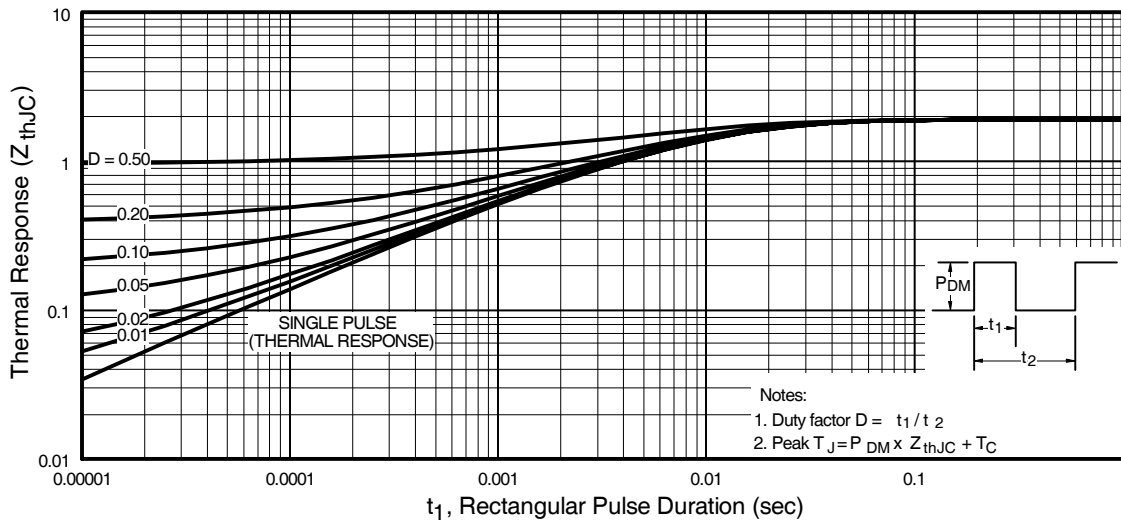

Fig 11. Maximum Effective Transient Thermal Impedance, Junction-to-Case

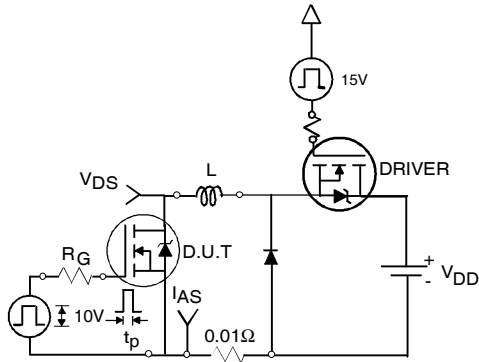

Fig 12a. Unclamped Inductive Test Circuit

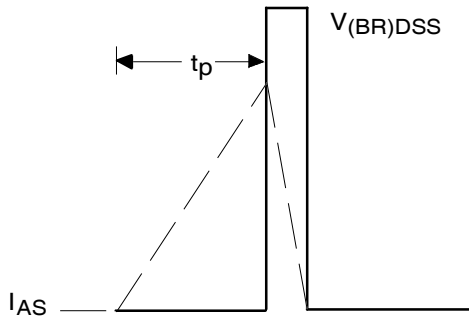

Fig 12b. Unclamped Inductive Waveforms

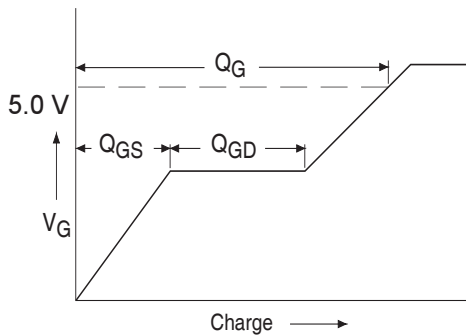

Fig 13a. Basic Gate Charge Waveform

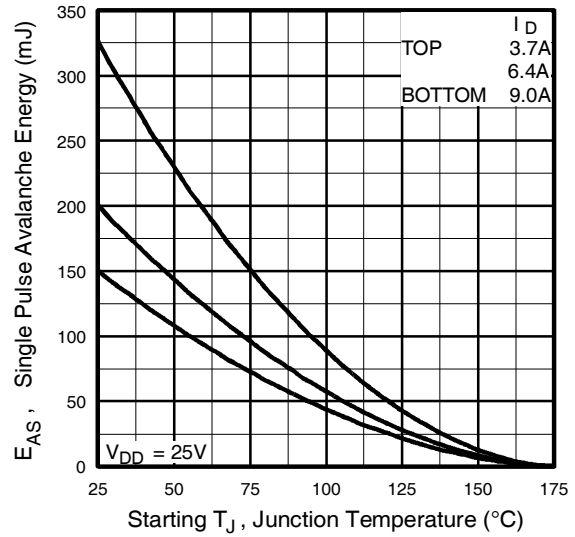

Fig 12c. Maximum Avalanche Energy Vs. Drain Current

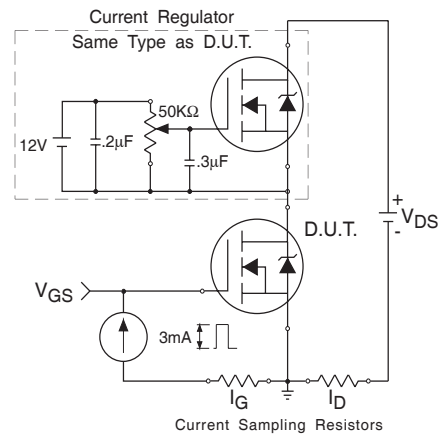
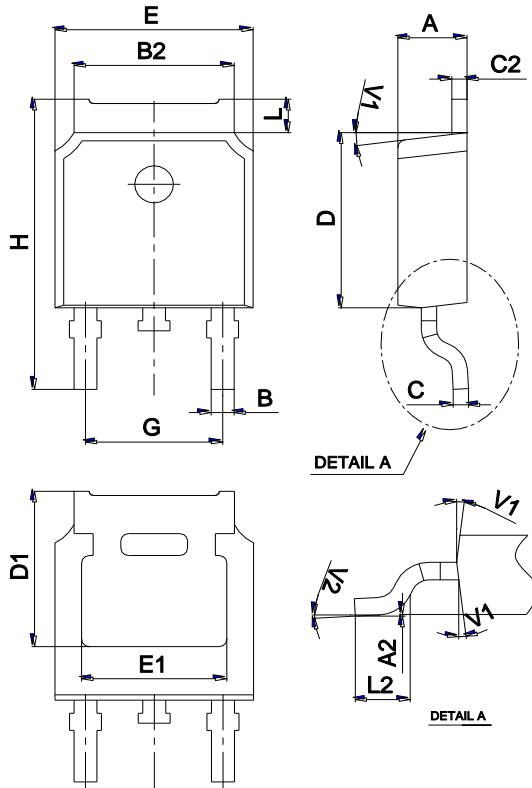

Fig 13b. Gate Charge Test Circuit

Package Mechanical Data TO-252



| Ref. | Dimensions | | | | | |
|------|-------------|------|-------|----------|------|-------|
| | Millimeters | | | Inches | | |
| | Min. | Typ. | Max. | Min. | Typ. | Max. |
| A | 2.10 | | 2.50 | 0.083 | | 0.098 |
| A2 | 0 | | 0.10 | 0 | | 0.004 |
| B | 0.66 | | 0.86 | 0.026 | | 0.034 |
| B2 | 5.18 | | 5.48 | 0.202 | | 0.216 |
| C | 0.40 | | 0.60 | 0.016 | | 0.024 |
| C2 | 0.44 | | 0.58 | 0.017 | | 0.023 |
| D | 5.90 | | 6.30 | 0.232 | | 0.248 |
| D1 | 5.30REF | | | 0.209REF | | |
| E | 6.40 | | 6.80 | 0.252 | | 0.268 |
| E1 | 4.63 | | | 0.182 | | |
| G | 4.47 | | 4.67 | 0.176 | | 0.184 |
| H | 9.50 | | 10.70 | 0.374 | | 0.421 |
| L | 1.09 | | 1.21 | 0.043 | | 0.048 |
| L2 | 1.35 | | 1.65 | 0.053 | | 0.065 |
| V1 | | 7° | | | 7° | |
| V2 | 0° | | 6° | 0° | | 6° |

Ordering information

| Order code | Package | Baseqty | Delivery mode |
|----------------|---------|---------|---------------|
| UMW IRLR3410TR | TO-252 | 2500 | Tape and reel |