

DARLINGTON ARRAY DRIVER IC

DESCRIPTION

The ULN2803 is high-voltage, high-current darlington driver IC composed of 8 NPN darlington pairs. All units share the emitter in common, and each unit adopts open-collector output. A 2.7KΩ resistor is connected to each darlington pair in serial, which is compatible with TTL and 5V CMOS for data processing without logic buffer.

Sink current of ULN2803 is up to 500mA, when it is off state, the withstand voltage is 50V and the output can runs with high load current, which provides solutions for various interface.

FEATURES

- ◆ Wide operating voltage range
- ◆ 8-ch high-gain darlington array
- ◆ High output voltage (up to 50V)
- ◆ High output current (up to 500mA)
- ◆ Able to connect to TTL, CMOS, PMOS directly
- ◆ Clamp diodes for switching inductive loads

APPLICATIONS

- ◆ Relay driver
- ◆ DC lamp driver
- ◆ Step motor driver
- ◆ Magnet valve
- ◆ DC brushless motor driver

ORDERING INFORMATION

Part No.	Package	Marking	Hazardous Substance Control	Packing Type
UMW ULN2803AN	DIP-18-300-2.54	ULN2803AN	Halogen free	Tube
UMW ULN2803A	SOP-18-375-1.27	ULN2803A	Halogen free	Tape&Reel

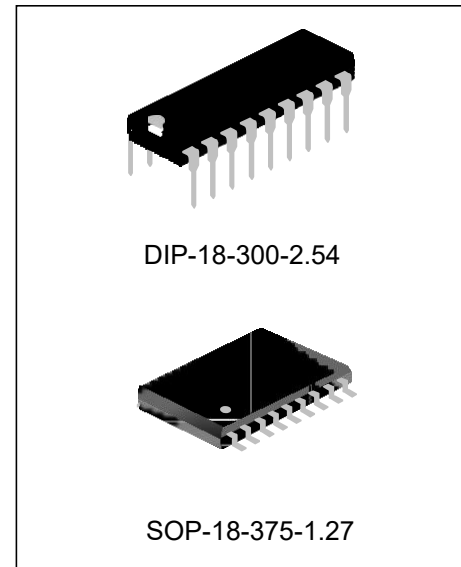

DARLINGTON ARRAY DRIVER IC

BOLBK DIAGRAM

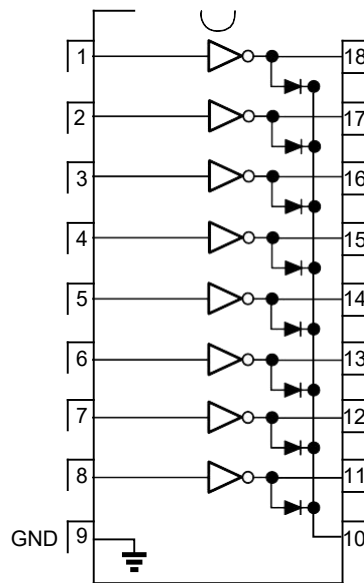

Pin		I/O	Description
Pin name	Pin		
<1:8>	1-8	Input	Channel 1~8 darlington input
<11:18>	18-11	Output	Channel 1~8 darlington output
(GND)	9	GND	Ground
COM	10	Input/ Output	Positive of clamp diode (used with inductive load)

ABSOLUTE MAXIMUM RATINGS

Parameter	Symbol	Ratings	Units
Input Voltage	V_{IN}	-0.5~30	V
Output Voltage	V_{OUT}	-0.5~50	V
Clamp Diode Reverse Voltage	V_R	55	V
Output Current	I_{OUT}	500	mA
Clamp Diode Forward Current	I_F	25	mA
Storage Temperature	T_{STG}	-55~150	°C
Operating Temperature	T_{OPR}	-40~85	°C
Operating Junction Temperature	T_J	-40~150	°C

DARLINGTON ARRAY DRIVER IC

ELECTRICAL CHARACTERISTICS (Ta = 25 °C UNLESS OTHERWISE NOTED)

Parameter	Symbol	Test conditions	Min.	Typ.	Max.	Units
Output Leakage Current	I _{CEX}	T _A =25°C, V _{CE} =50V(Figure 1)	--	--	20	µA
		T _A =85°C, V _{CE} =50V(Figure 1)	--	--	100	
CE Saturation Voltage	V _{CE(sat)}	I _{OUT} =350mA, I _{IN} =500 µA(Figure 3)	--	1.3	1.6	V
		I _{OUT} =250mA, I _{IN} =350 µA(Figure 3)	--	1.1	1.3	
		I _{OUT} =100mA, I _{IN} =250 µA(Figure 3)	--	0.9	1.1	
Input Current (Output On)	I _{I(ON)}	V _I =3.85V(Figure 4)	--	0.93	1.35	mA
Input Current (Output Off)	I _{I(OFF)}					µA
		T _A =+25°C, I _C =500µA(Figure 5)	50	100	--	
		T _A =+85°C, I _C =500µA(Figure 5)	25	50	--	
Input Voltage (Output On)	V _{I(ON)}	V _{CE} =2.0V, I _C =200mA(Figure 6)	--	--	2.4	V
		V _{CE} =2.0V, I _C =250mA(Figure 6)	--	--	2.7	
		V _{CE} =2.0V, I _C =300mA(Figure 6)	--	--	3.0	
Input Capacitance	C _I		--	15	30	pF
Turn-on Delay	t _{MH}	0.5V _I to 0.5 V _O	--	--	1.0	µS
Turn-off Delay	t _{ML}	0.5V _I to 0.5 V _O	--	--	1.0	
Clamp Diode Reverse Current	I _R		--	--	--	µA
		T _A =+25°C, V _R =50V(Figure 7)	--	--	10	
		T _A =+85°C, V _R =50V(Figure 7)	--	--	50	
Clamp Diode Forward Voltage	V _F	I _F =350mA(Figure 8)	--	1.7	2.0	V

Notes: 1. Absolute maximum ratings are those values beyond which the device could be permanently damaged.

Absolute maximum ratings are stress ratings only and functional device operation is not implied. Electrical Characteristics are for normal operating range;

2. All the conditions are suitable for darlington pairs unless otherwise noted;

3. In general, with 70°C, V_{CE} (Sat)= 1.6V, pulse width=20ms, the continuous operating current of each channel is 350mA.

DARLINGTON ARRAY DRIVER IC

TYPICAL CHARACTERISTIC CURVES

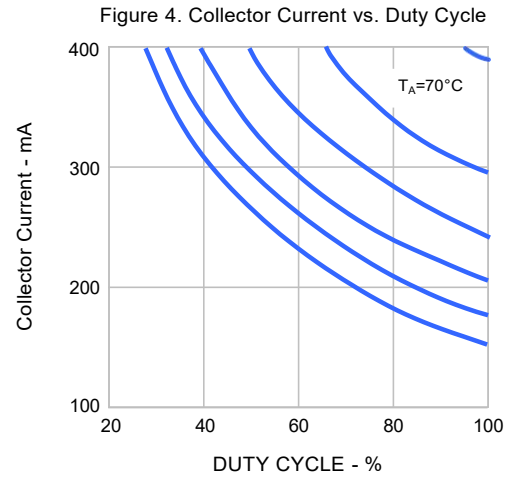
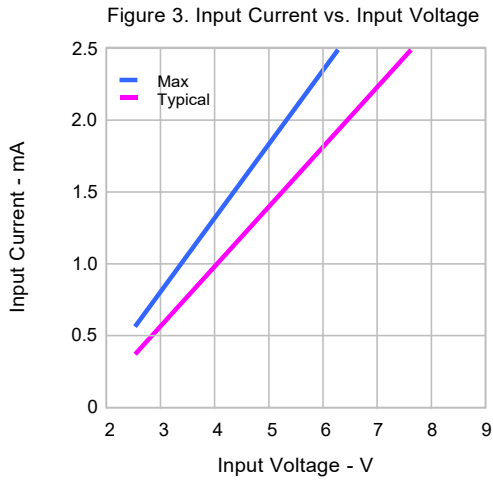
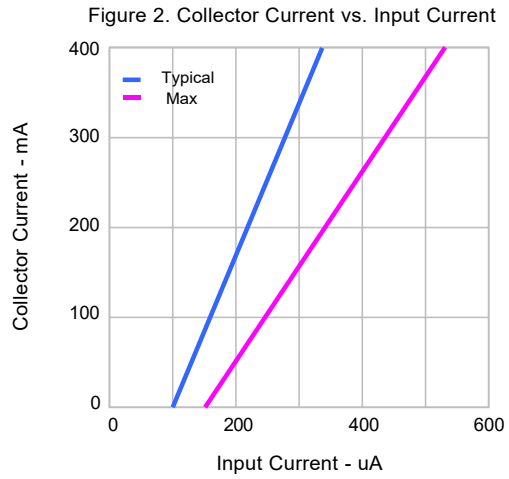
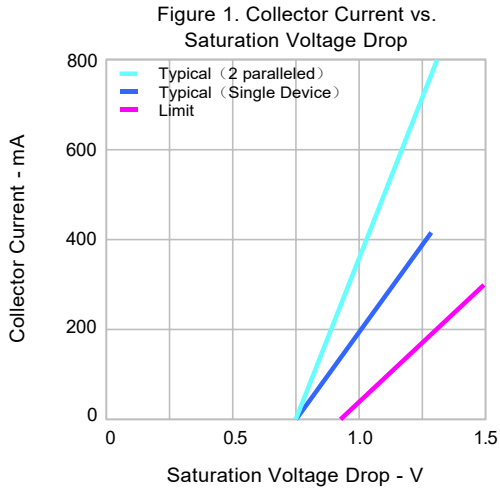

INTERNAL EQUIVALENT CIRCUIT

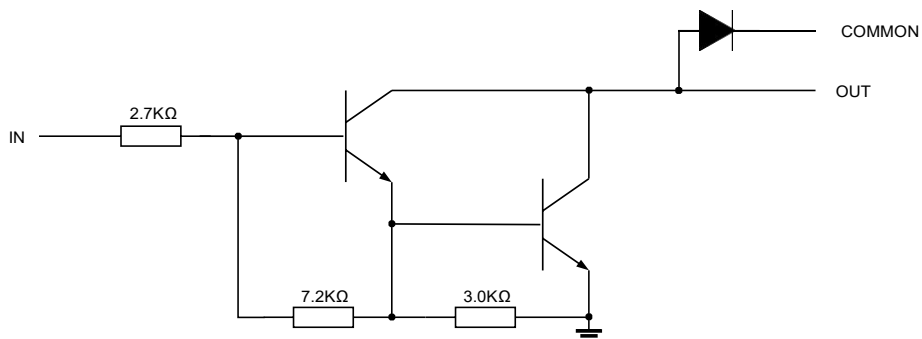

TEST CIRCUITS



图1



图5

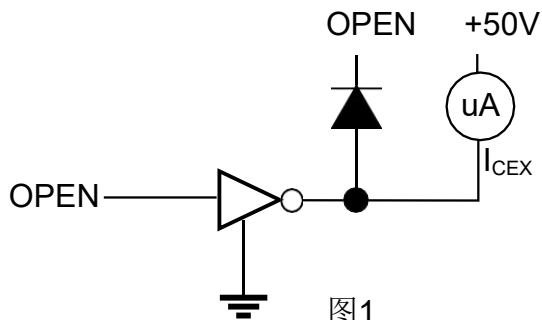

图2

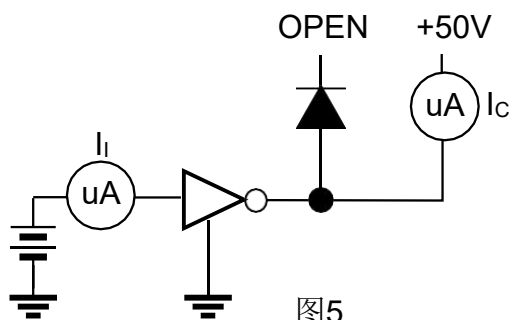

图6

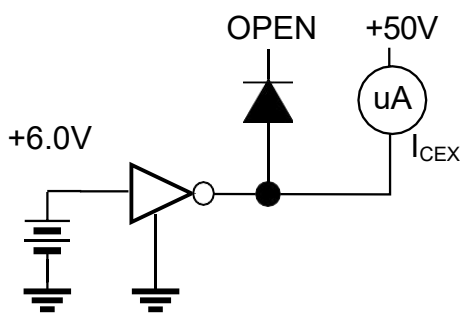

图3

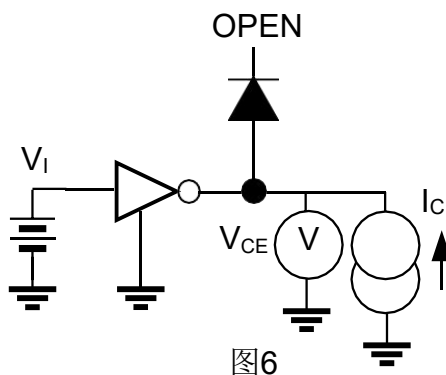

图7

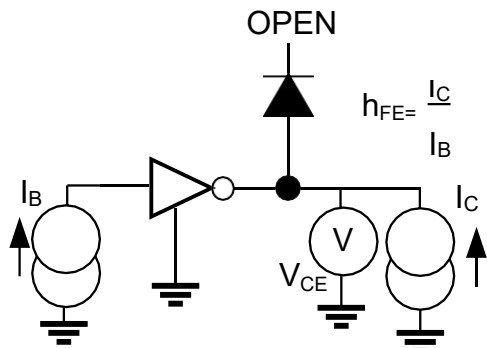

图4

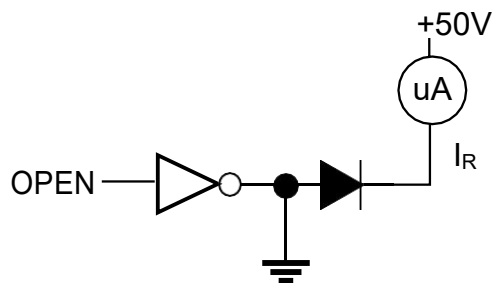

图8

PACKAGE OUTLINE

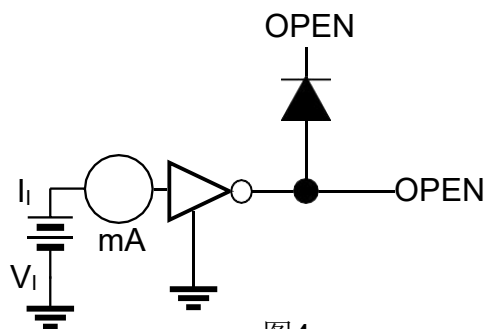
DARLINGTON ARRAY DRIVER IC

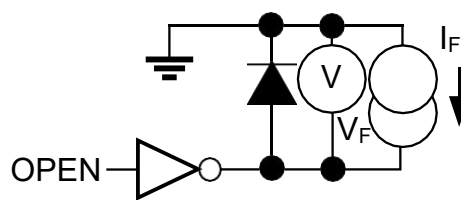