

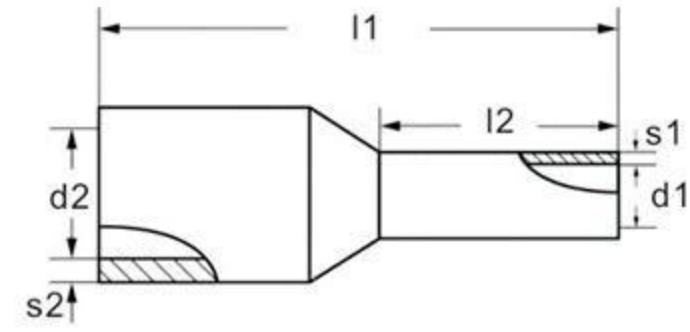



















































CORD END TERMINALS

- Material
- Insulation: Nylon
- Terminal Body: Copper
- Plating: Tin



ITEM NO.	DIMENSIONS						A.W.G mm ²	FRENCH COLOR	GERMANY COLOR	DIN COLOR		
	l1	l2	s1	s2	d1	d2						
E0306	11.0	6.0	0.15	0.3	0.8	1.9	24 A.W.G 0.34mm ²					
E0308	13.0	8.0									PINK	TURQUOISE
E0506	12.0	6.0	0.15	0.3	1.0	22 A.W.G 0.5mm ²						
E0508	14.0	8.0								WHITE	ORANGE	WHITE
E0510	16.0	10.0								WHITE	ORANGE	WHITE
E0512	18.0	12.0								WHITE	ORANGE	WHITE
E7506	12.0	6.0	0.15	0.3	1.2	20 A.W.G 0.75mm ²						
E7508	14.0	8.0								BLUE	WHITE	GREY
E7510	16.0	10.0								BLUE	WHITE	GREY
E7512	18.0	12.0								BLUE	WHITE	GREY
E1006	12.0	6.0	0.15	0.3	1.4	18 A.W.G 1.0mm ²						
E1008	14.0	8.0								RED	YELLOW	RED
E1010	16.0	10.0								RED	YELLOW	RED
E1012	18.0	12.0								RED	YELLOW	RED
E1508	14.5	8.0	0.15	0.3	1.7	16 A.W.G 1.5mm ²						
E1510	16.5	10.0								BLACK	RED	BLACK
E1512	18.5	12.0								BLACK	RED	BLACK
E1518	24.5	18.0								BLACK	RED	BLACK
E2508	15.5	8.0	0.15	0.3	2.3	14 A.W.G 2.5mm ²						
E2510	17.5	10.0								GREY	BLUE	BLUE
E2512	18.5	12.0								GREY	BLUE	BLUE
E2518	25.5	18.0								GREY	BLUE	BLUE
E4009	16.5	9.0	0.2	0.4	2.8	12 A.W.G 4.0mm ²						
E4010	17.5	10.0								ORANGE	GREY	GREY
E4012	19.5	12.0								ORANGE	GREY	GREY
E4018	25.5	18.0								ORANGE	GREY	GREY
E6010	18.5	10.0	0.2	0.4	3.5	10 A.W.G 6.0mm ²						
E6012	22.0	12.0								GREEN	BLACK	YELLOW
E6018	28.0	18.0								GREEN	BLACK	YELLOW
EE1012	22.0	12.0	0.2	0.5	4.5	8 A.W.G 10.0mm ²						
EE1018	28.0	18.0								BROWN	IVORY	RED
EE1612	22.0	12.0	0.2	0.5	5.8	6 A.W.G 16.0mm ²						
EE1618	28.0	18.0								IVORY	GREEN	BLUE
EE2516	28.0	16.0	0.2	0.5	7.5	4 A.W.G 25mm ²						
EE2518	30.0	18.0								BLACK	BROWN	YELLOW
EE2522	34.0	22.0								BLACK	BROWN	YELLOW
EE3516	30.0	16.0	0.2	0.5	8.3	2 A.W.G 35mm ²						
EE3518	32.0	18.0								RED	BEIGE	RED
EE3525	39.0	25.0								RED	BEIGE	RED
EE5020	36.0	20.0	0.3	0.5	10.3	1/0 A.W.G 50mm ²						
EE5025	41.0	25.0								BLUE	OLIVE	BLUE
EE7020	37.0	20.0	0.4	0.5	13.5	2/0 A.W.G 70mm ²						
EE7027	42.0	27.0								YELLOW	YELLOW	YELLOW
EE9525	48.0	25.0	0.4	0.8	14.5	3/0 A.W.G 95mm ²						
EE12027	47.6	27.0								RED	RED	RED
EE12027	47.6	27.0	0.45	0.8	16.5	4/0 A.W.G 120mm ²						
EE15032	53.0	32.0								BLUE	BLUE	BLUE
EE15032	53.0	32.0	0.5	1.0	19.6	250/300 A.W.G ² 150mm						
EE15032	53.0	32.0								YELLOW	YELLOW	YELLOW

