

REV	DESCRIPTION	DRFT	DATE

Electrical:

UL Standard

- 1. Rated voltage: 300V
- 2. Rated current: 15A

IEC Standard

- 1. Rated voltage: 320V
- 2. Rated current: 10A

Notes :

- 1. Pitch: 5.08mm, Poles: N=04~48P
- 2. Withstanding voltage : AC1600V/1Min.
- 3. Operating temperature : -40°C~+105°C
- 4. RoHS Compliance
- 5. Safty Approval : 
- 6. Undimensioned Tolerances:

Pitch mm	Range In		Nominal Dimension Range In mm					Tolerance
	6 ~ 10	10 ~ 24	≤30	30 ~ 60	60 ~ 100	100 ~ 150	>150	
≤6	6 ~ 10	10 ~ 24	±0.30	±0.50	±0.70	±1.00	±1.30	0.1/10
±0.15	±0.20	±0.30	±0.30	±0.50	±0.70	±1.00	±1.30	±2'

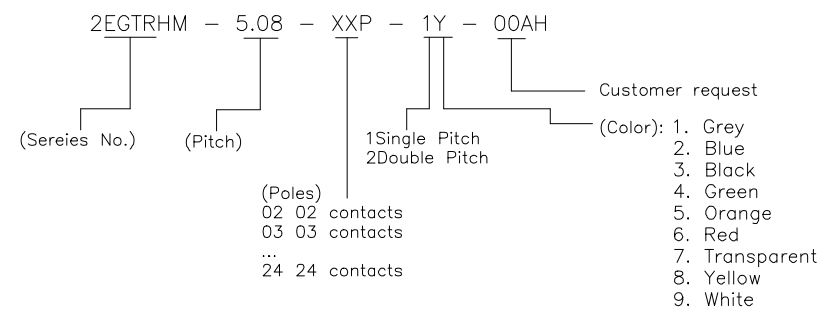
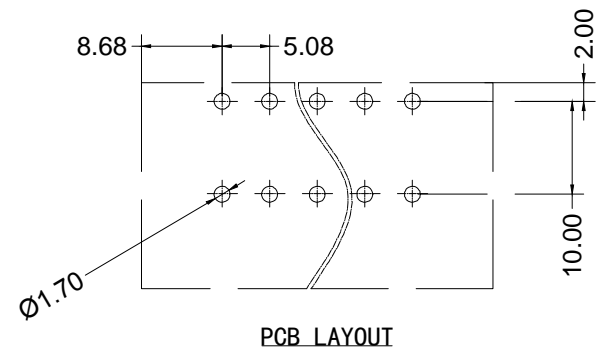
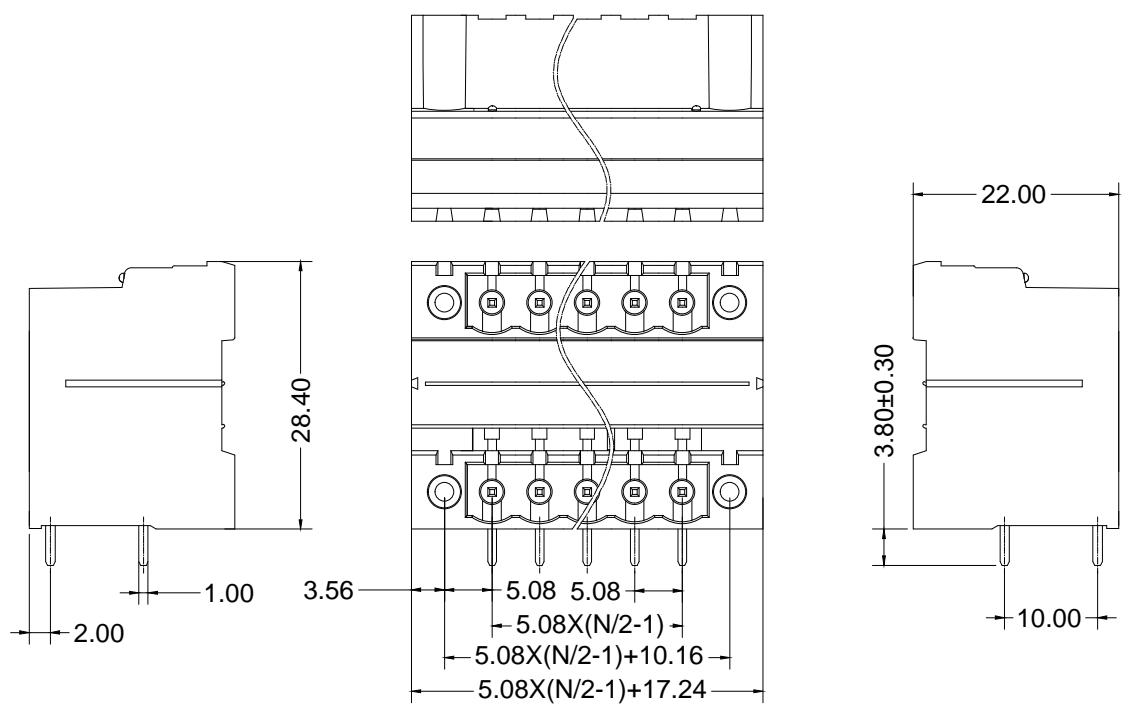

ITEM	NAME OF PART	MATERIAL	NOTES
3	Pin	Brass	Sn Plated
2	Cover	PA66	UL94V-0
1	Housing	PA66	UL94V-0

DETACHED LISTS

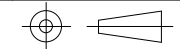
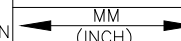

宁波冠泰电子有限公司  
NINGBO GOLTEN ELECTRONICS CO., LTD.

APPD: MA_5/23/16	NAME: 2EGTRHM-5.08-XXP-1Y-00AH		
CHKD: Yu_5/22/16	TITLE: CUSTOMER DRAWING		
DRFT: Dong_4/17/20	REV	D0-1	
 THIRD ANGLE PROJECTION	DRAWING NO. 2EGTRHM-5.08-XXP-1Y-00AH		SHEET 1/1
	 DO NOT SCALE DRAWING	SCALE	1:1